

DIN-Rail Accessories Industrial Power Relay RT

- For Industrial Power Relay RT
pinnings 3.5 mm / 5 mm; relay height 15.7 mm
- New retainer clip with ejection function
- Easy replacement of relays on a densely packed DIN rail
- No reduction of protection class or creepage/clearance with plastic retainer
- Simple plug-in indicator- and protection modules
- White snap-on marking tags

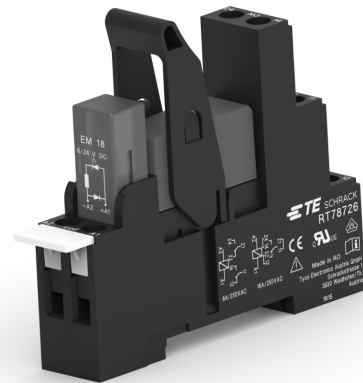

Premium socket with screwless terminals for DIN rail mounting

RT 78 72P Premium socket, logical terminal arrangement

- Screwless Clamps
- Mounting of solid wires without tool
- Double Clamps per terminal
- Jumper links for interconnection
- Logical terminal arrangement

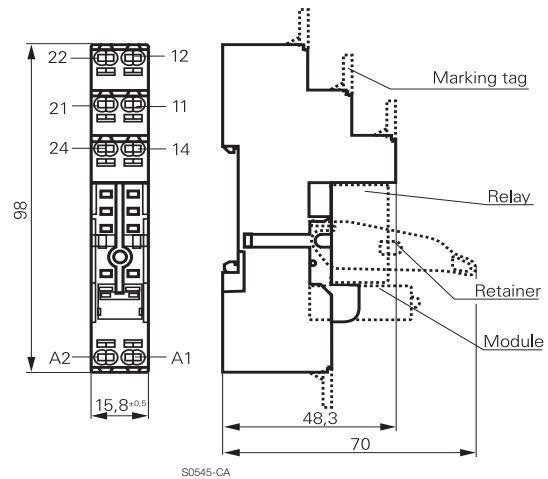
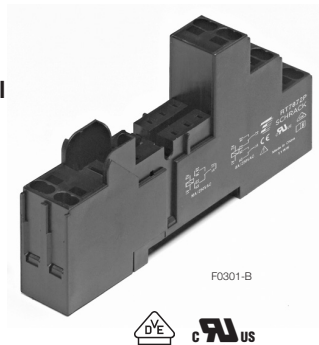

Approvals

VDE Cert. No. 40007571, cULus E135149

Technical data

Rated voltage/Max. switching voltage AC	240/400 VAC
Rated current	2 x 8 A, 16 A*)
Dielectric strength	
coil-contact circuit	5000 V _{rms}
open contact circuit	1000 V _{rms}
adjacent contact circuits	2500 V _{rms}
Clearance / creepage	
coil-contact circuit	≥ 10/10 mm
Material group of insulation parts	IIIa
Flammability class UL 94	V-0
Insulation to IEC 60664-1	
Type of insulation coil-contact circuit	reinforced
open contact circuit	functional
adjacent contact circuits	functional
Rated insulation voltage	250 V
Pollution degree	2
Rated voltage system	230 / 400 V
Overtoltage category	III

*) For 1 pole relays (16 A) the relay terminals 11-21, 12-22 and 14-24 have to be bridged.

- Not suitable for bistable relays with 2 coils!

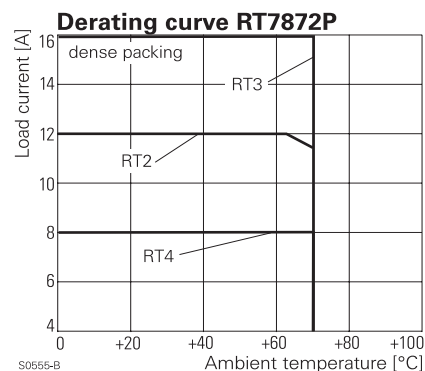

DIN-Rail Accessories Industrial Power Relay RT (Continued)

Technical data (continued)

Material compliance: EU RoHS/ELV, China RoHS, REACH, Halogen content refer to the Product Compliance Support Center at www.te.com/customersupport/rohssupportcenter

Ambient temperature range	
for mounting/handling	-20...+70°C
in operation	-40...+70°C
Terminals	screwless
Wire strip length	12 mm
Wire cross section	
solid wire	1x0.75/1/1.5mm ² 2x0.75/1mm ² 2x1.5mm ²
with stand. isolation (no oversize isolation)	2x1.5mm ²
stranded wire	
without bootlace crimp	1x0.75/1/1.5mm ² 2x0.75/1mm ² 2x1.5mm ²
without bootlace crimp with stand. isolation	2x1.5mm ²
with bootlace crimp	1x0.75/1mm ² 2x0.75mm ² 2x1.5mm ²
with bootlace crimp without isolation	1x1.5mm ²
or min 18 mm long	

For stranded wires with braids 0.05 mm or smaller the use of bootlace crimps is recommended. When using stranded wires without bootlace crimp, the clamp must be opened during insertion.

Insertion cycles	A (10)
Max. Insertion Force total	100 N
Mounting distance	≥ 0, dense packing
Weight	36 g
Packaging unit	10 pcs

Socket with screwless terminals for DIN rail mounting

Type	Part Number
RT 78 72P Premium socket, logical terminal arrangement Socket with screwless terminals, pinning 5 mm for DIN rail mounting	1860200-1

Accessories for RT 78 72P

Type	Part Number
RT 17 017 Plastic retaining clip, relay height 15.7 mm	2022103-1
RT 17 040 Marking tag	2-1415038-1
RT 17 0P1 Jumper link, max load 12 A	1860211-1

How to use, Precautions

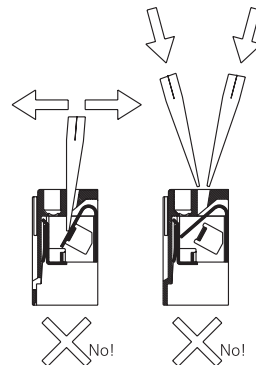
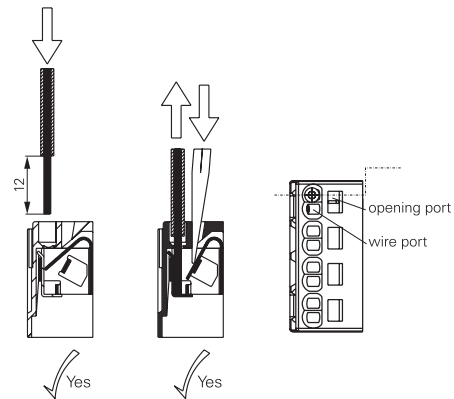
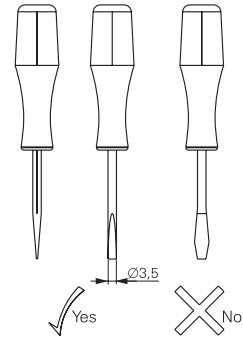

Jumper link

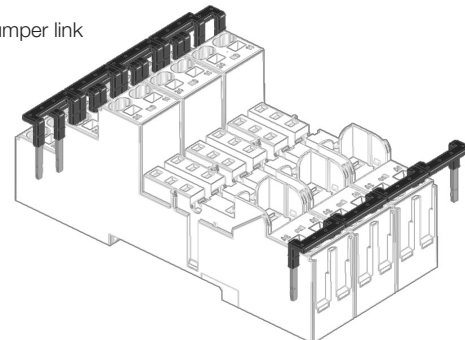

DIN-Rail Accessories Industrial Power Relay RT (Continued)

Socket with screw-type terminals for DIN rail mounting

RT 78 724 Socket with screw-type terminals, pinning 3.5 mm for DIN rail mounting

RT 78 726 Socket with screw-type terminals, pinning 5 mm for DIN rail mounting, logical terminal arrangement

- DIN-rail socket with logical setup of connections (input/output)
- High quality rising clamp terminals
- Captive combination terminal screws
- Jumper bars for interconnection

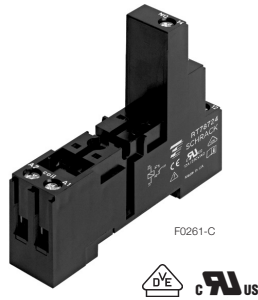

RT 78 724

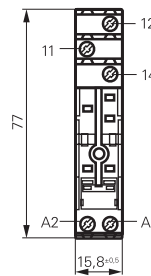

S0416-CA

RT 78 726

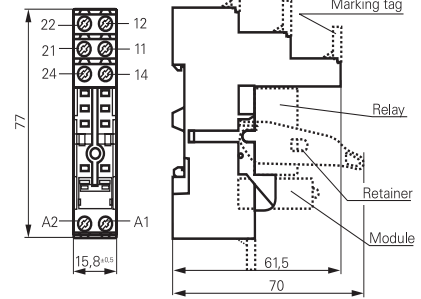

S0416-CB

RT 78 725 Socket with screw-type terminals, pinning 5 mm for DIN rail mounting, conventional terminal arrangement

- Conventional terminal arrangement

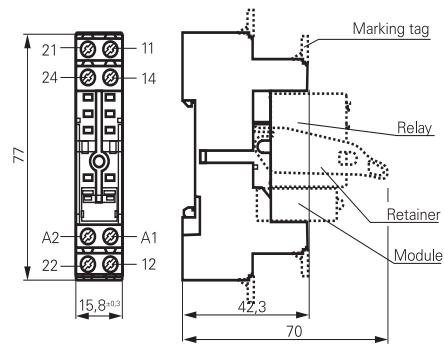
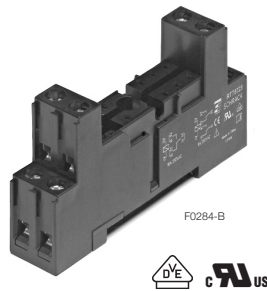

S0540-BT

Approvals

VDE Cert. No. 40007571, cULus E135149

Technical data RT78724/RT78726 RT78725

Rated voltage/Max. switching voltage AC	240/400 VAC		
Rated current	12 A, 2 x 8 A, 16 A*)		
Dielectric strength	coil-contact circuit	5000 V _{rms} 4000 V _{rms}	
	open contact circuit	1000 V _{rms} 1000 V _{rms}	
	adjacent contact circuits	2500 V _{rms} 2500 V _{rms}	
Clearance / creepage	coil-contact circuit	≥ 10/10 mm ≥ 4.7/4.7 mm	
	Material group of insulation parts	IIIa	
Flammability class UL 94	V-0		
Insulation to IEC 60664-1	Type of insulation	coil-contact circuit reinforced	basic
		open contact circuit	functional
		adjacent contact circuits	functional
	Rated insulation voltage	250 V	
Pollution degree	2		
Rated voltage system	230 / 400 V		
Overvoltage category	III		

Material compliance: EU RoHS/ELV, China RoHS, REACH, Halogen content refer to the Product Compliance Support Center at www.te.com/customer-support/rohssupportcenter

*) For 1 pole relays (16 A) the relay terminals 11-21, 12-22 and 14-24 have to be bridged.
For 1 pole relays (12 A) the relay terminals 11-12-14 have to be connected to the socket terminals 21-12-14.

- Not suitable for bistable relays with 2 coils!

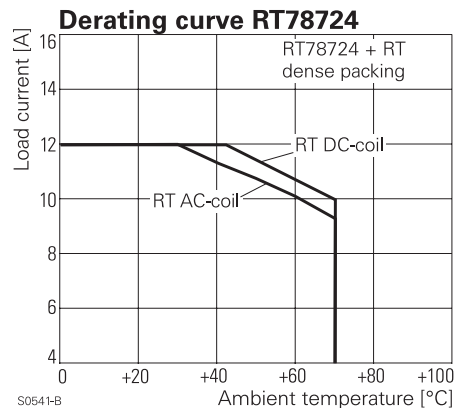

S0541-B

DIN-Rail Accessories Industrial Power Relay RT (Continued)

Technical data (continued) RT78724/RT78726 RT78725

Ambient temperature range for mounting/handling	-20...+70°C
in operation	-40...+70°C
Terminals	screw
Terminals screw torque acc. IEC 61984	0.5 Nm
max.	0.7 Nm
Terminal Screw size	M3
Wire strip length	8 mm
Wire cross section	
single wire	2 x 2.5 mm ²
fine wire	2 x 2.5 mm ²
with bootlace crimp (DIN 46228/1)	2 x 1.5 mm ²
Insertion cycles	A (10)
Max. Insertion Force total	100 N
Mounting distance	≥ 0, dense packing
Weight	36 g
Packaging unit	10 pcs

Socket with screw-type terminals for DIN rail mounting

Type		Part Number
RT 78 724	Socket with screw-type terminals, pinning 3.5 mm for DIN rail mounting, logical terminal arrangement	8-1415035-1
RT 78 726	Socket with screw-type terminals, pinning 5 mm for DIN rail mounting, logical terminal arrangement	6-1415035-1
RT 78 725	Socket with screw-type terminals, pinning 5 mm for DIN rail mounting, conventional terminal arrangement	1860306-1

Accessories for RT 78 724, RT 78 725, RT 78 726

Type		Part Number
RT 17 017	Plastic retaining clip, relay height 15.7 mm	2022103-1
RT 28 816	Metal retaining clip, relay height 15.7 mm	1415540-8
RT 17 040	Marking tag	2-1415038-1
RT 17 0R8	Jumper bar, max load 12 A for connection of up to 8 RT sockets	1860517-8

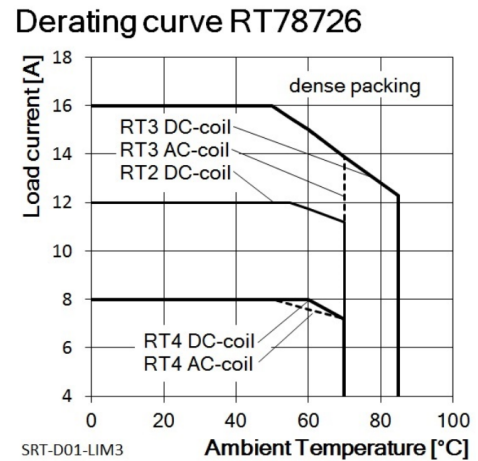
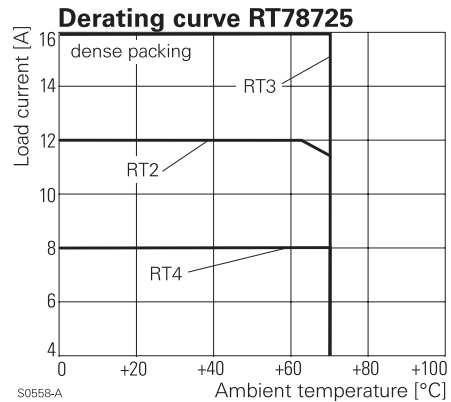

Marking tags

- White marking area 15.5 x 6 mm
- Snaps on socket in up to 4 positions

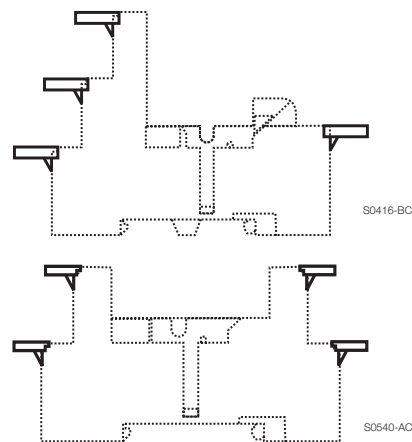
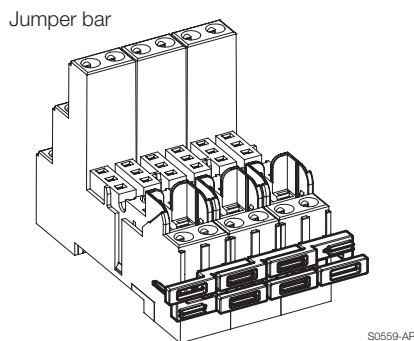

DIN-Rail Accessories Industrial Power Relay RT (Continued)

LED- and Protection Modules for RT 78 72P, RT 78 724, RT 78 725, RT 78 726

Easy insertion of module into the socket
Wiring in parallel to the coil

Type			Part Number
PTM TO 0A0	EM09	Protection diode (standard, A1+,A2-)	9-1415036-1
PTM TO 0L0	EM01	Protection diode (A1-, A2+)	1415037-1
PTM UO 524	EM02	RC-network 6...60 VAC	1-1415037-1
PTM UO 730	EM03	RC-network 110...230 VAC	2-1415037-1
PTM VO 524	EM04	Varistor 24 VAC	3-1415037-1
PTM VO 615	EM13	Varistor 115 VAC	6-1415365-1
PTM VO 730	EM05	Varistor 230 VAC	4-1415037-1
PTM DO 730	EM31	Residual current bypass RC 110...230 VAC	1415037-2
PTM RO 730	EM29	Residual current bypass resistor 110...230 VAC	1-1415539-2



LED

PTM LO 024	EM18	red LED 6...24 VDC w. prot. diode (std, A1+, A2-)	5-1415036-1
PTM GO 024	EM12	green LED 6...24 VDC w. prot. diode (std, A1+, A2-)	2-1415036-1
PTM L1 024	EM08	red LED 6...24 VDC w. prot. diode (A1-, A2+)	8-1415036-1
PTM LO 060	EM16	red LED 24...60 VDC w. prot. diode (std, A1+, A2-)	5-1415539-3
PTM GO 060	EM25	green LED 24...60 VDC w. prot. diode (std, A1+, A2-)	7-1415539-7
PTM LO 110	EM19	red LED 60...110 VDC w. prot. diode (A1+, A2-)	2-1415392-1
PTM GO 110	EM26	green LED 60...110 VDC w. prot. diode (A1+, A2-)	1-1415539-7
PTM LO 220	EM27	red LED 110...220 VDC w. prot. diode (A1+, A2-)	1-1415539-4
PTM GO 220	EM28	green LED 110...220 VDC w. prot. diode (A1+, A2-)	1-1415539-6
PTM LO 524	EM07	red LED 6...24 VDC/VAC	6-1415036-1
PTM GO 524	EM11	green LED 6...24 VDC/VAC	3-1415036-1
PTM LO 560	EM14	red LED 24...60 VDC/VAC	1-1415539-3
PTM GO 560	EM30	green LED 24...60 VDC/VAC	1-1415539-5
PTM LO 730	EM06	red LED 110...230 VAC	7-1415036-1
PTM GO 730	EM10	green LED 110...230 VAC	4-1415036-1

Relay Packages

Complete packages consisting of a relay mounted on a socket: see Relay Package RT

X-ON Electronics

Largest Supplier of Electrical and Electronic Components

Click to view similar products for [Relay Sockets & Fixings](#) category:

Click to view products by [TE Connectivity](#) manufacturer:

Other Similar products are found below :

[00008258500](#) [00111976502](#) [0000-825-81-00](#) [60SY4S05](#) [M41G](#) [670-0125](#) [670-0127](#) [6700152](#) [670-0153](#) [6700156](#) [D258-2TS00](#) [70-309](#) [7-1393143-3](#) [7-1616360-5](#) [8000-DG2-5](#) [911361](#) [9-1616339-5](#) [PJF11N](#) [GDA12HA](#) [GDA12HD](#) [GDA12SA](#) [GDA12SD](#) [GDA16HD](#) [GDA22HA](#) [GDA95A](#) [GDA95D](#) [GFX20](#) [PT08QN](#) [PT 1/8 D = 3.2](#) [GUA1](#) [GUA2-11](#) [GUA4-04](#) [GUA4-31](#) [GUM5R](#) [GUR-120](#) [GUR-24](#) [GUR-240](#) [GUR-277](#) [GURX-277](#) [GUW12](#) [GUW95](#) [GUZ63L](#) [R99-11 FOR MY\(NAMEPLATE\)](#) [D52PR2T](#) [RES100K](#) [1310H-HDC](#) [1390H-1ST](#) [1393824-3](#) [1390H-2PC](#) [1410-2SM](#)