

## Type SM Series

### Key Features

Low Profile Design

Available on Tape

Very Wide Value Range

Ideal for Power Circuitry

Available in 4 ratings up to 7 Watts

Flameproof Coating  
UL94V0



TE Connectivity (TE) introduces a surface mount power resistor suited to meet today's circuit design needs. Each size offers low profile case design with flexible tinned copper terminations for reliable solder joints. All styles utilize a fully welded construction technique, unlike other designs that rely solely on tinned termination connections. These features allow the SM Series to withstand the higher temperatures associated with reflow, vapour phase, or infrared (IR) manufacturing processes without degradation. Now also available at 7W power rating.

### Characteristics – Electrical

	SMW – Wire	SMF – Metal Film
Values SM_2:	R10 – 200R	201R – 2M
Values SM_3:	R10 – 300R	301R – 2M
Values SM_5:	R10 – 500R	501R – 2M
Values SM_7:	R10 – 1K0	1K1 – 2M
Value Grid:	E24	
Resistance Tolerance:	1% or 5%	
Power Rating @ 20°C SM_2:	2.0 Watts	
Power Rating @ 20°C SM_3:	3.0 Watts	
Power Rating @ 20°C SM_5:	5.0 Watts	
Power Rating @ 20°C SM_7:	7.0 Watts	
Derating:	See Curve Below	
Max Operating Voltage SM_2:	300 Volts	
Max Operating Voltage SM_3:	500 Volts	
Max Operating Voltage SM_5:	500 Volts	
Max Operating Voltage SM_7:	750 Volts	
Operating Temperature Range	-55 ~ 200°C	

## Environmental Characteristics

Test	Condition	SM (Wire)	SM (Metal Film)															
Temperature Coefficient of Resistance:	-55°C – +200°C	± 200ppm /°C	± 100ppm /°C															
Temperature Cycle	<table border="1"> <thead> <tr> <th>Step</th> <th>Temp.°C</th> <th>Time m</th> </tr> </thead> <tbody> <tr> <td>1</td> <td>-55±3</td> <td>30</td> </tr> <tr> <td>2</td> <td>Room Temp.</td> <td>2~3</td> </tr> <tr> <td>3</td> <td>200±3</td> <td>30</td> </tr> <tr> <td>4</td> <td>Room Temp</td> <td>2~3</td> </tr> </tbody> </table>	Step	Temp.°C	Time m	1	-55±3	30	2	Room Temp.	2~3	3	200±3	30	4	Room Temp	2~3	Resistance change Rate within ±1%	
Step	Temp.°C	Time m																
1	-55±3	30																
2	Room Temp.	2~3																
3	200±3	30																
4	Room Temp	2~3																
Short Time Overload:	5 times of rated wattage for 5 sec.	± 1%	± 0.5%															
Rated Load:	Rated voltage for 30 minutes	± 3%	± 1%															
Insulation Resistance:	500VDC	10,000 MΩ	10,000 MΩ															
Load Life:	70°C 1.5 hrs on 0.5 hrs off for 1000 hrs	± 2% (7W ±5%)	± 1% (7W ±5%)															
Humidity Load Life:	40°C ±2°C @ 90-95% RH 500 hrs 1.5 hrs on 0.5 hrs off	± 2% (7W ±5%)	± 1% (7W ±5%)															
Voltage Withstand:	500VAC for 60 seconds No Physical damage	No Physical damage																
Solderability:	235°C ±5°C for 2 seconds	95% coverage																
Resistance to Soldering Heat:	270°C ±5°C for 10 ±1seconds	Resistance value change within ± 1%																

## Dimensions

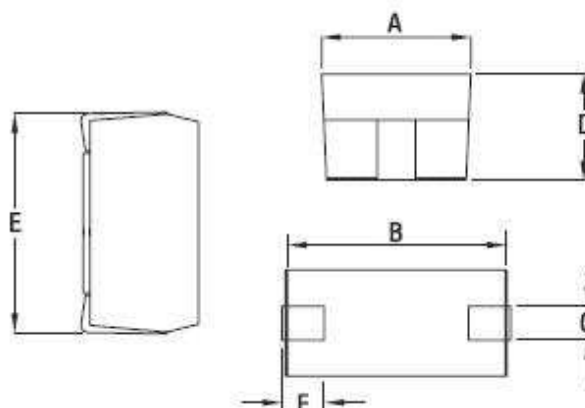

	A±0.3	B±0.3	C±0.3	D±0.3	E Max.	F±0.3	Reel Qty
SM 2W	4.0	6.7	1.4	3.55	7.9	1.5	2000
SM 3W	5.5	10.5	1.7	5.0	12.0	2.3	1000
SM 5W	7.3	13.5	1.7	6.8	17.0	2.5	1000
SM 7W	9.5	23.0	5.0	9.6	24.5	4.5	300

### Derating Curve

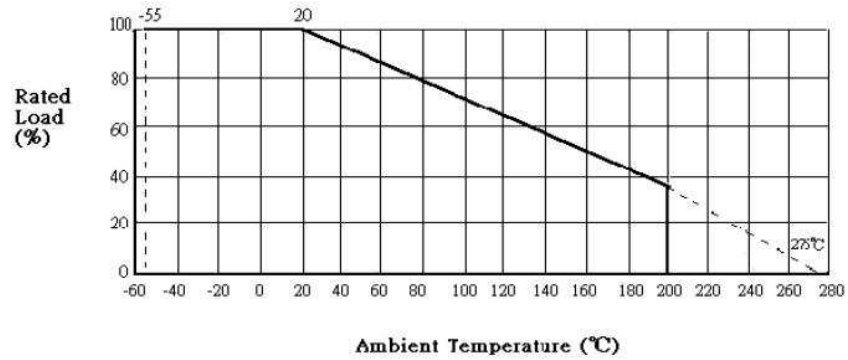

### Surface Temperature rise

SMW/SMF

### Surface Temperature Rise

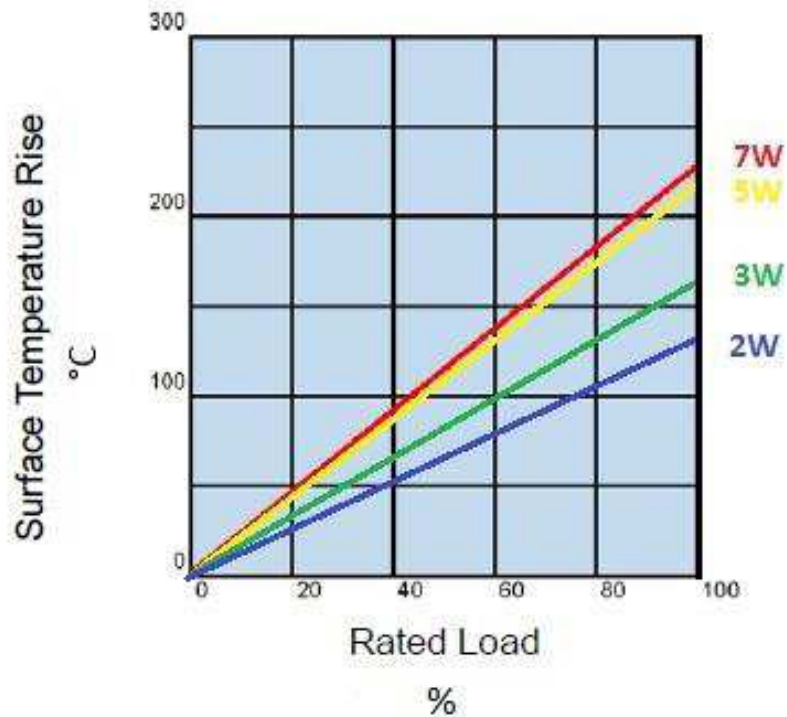

### SM Series Pulse Characteristics

#### SMW 2W

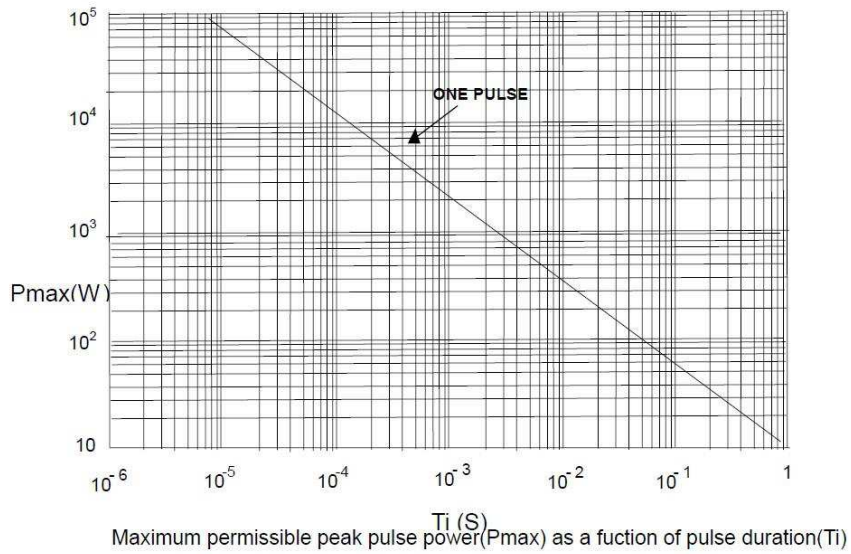

Condition test: Resistance change  $\leq \pm 5\%$  with pulse 1000 cycles as like the figure.(Reference Only)  
 1. Added power and added voltage are within the lower territory of this graph.  
 2. Added in normal temperature and humidity.

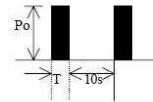

#### SMF 2W

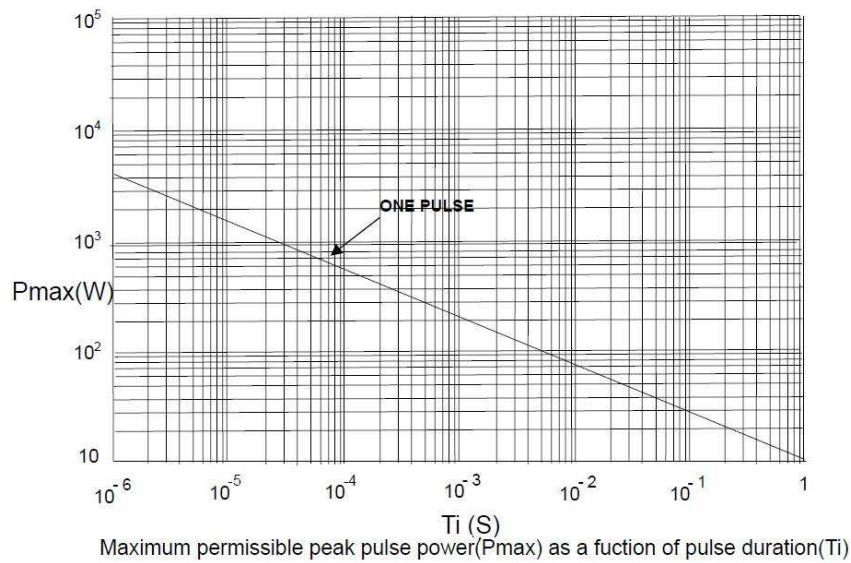

Condition test: Resistance change  $\leq \pm 5\%$  with pulse 1000 cycles as like the figure.(Reference Only)  
 1. Added power and added voltage are within the lower territory of this graph.  
 2. Added in normal temperature and humidity.

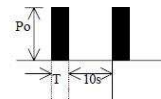

**SMW 3W**

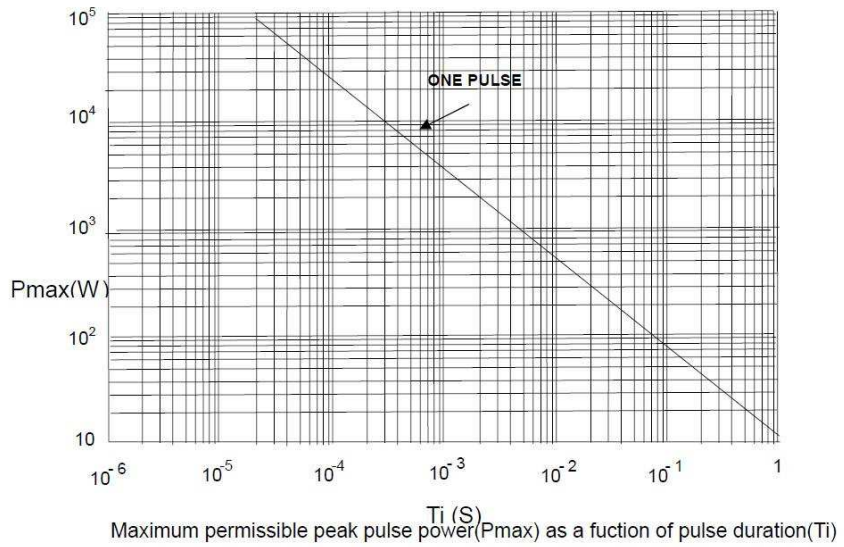

Condition test: Resistance change  $\leq \pm 5\%$  with pulse 1000 cycles as like the figure.(Reference Only)  
 1. Added power and added voltage are within the lower teritory of this graph.  
 2. Added in normal temperature and humidity.

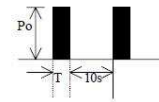

**SMF 3W**

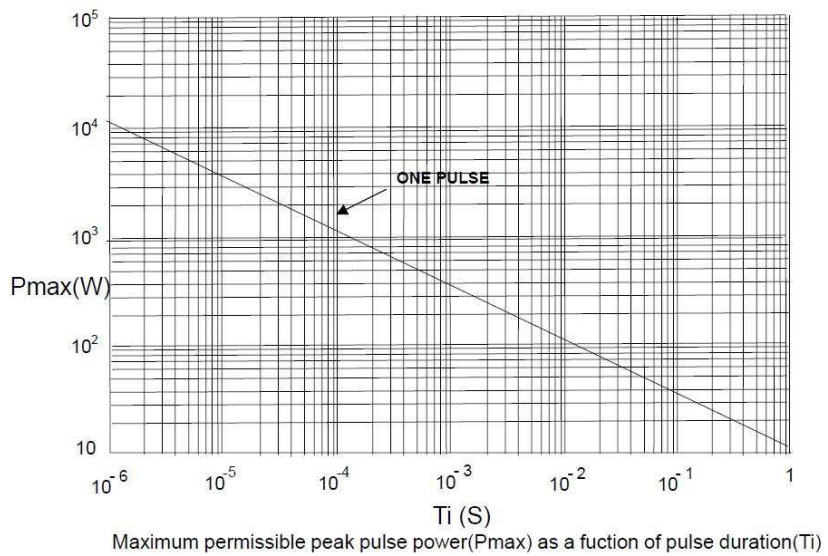

Condition test: Resistance change  $\leq \pm 5\%$  with pulse 1000 cycles as like the figure.(Reference Only)  
 1. Added power and added voltage are within the lower teritory of this graph.  
 2. Added in normal temperature and humidity.

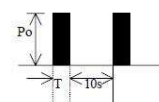

### SMW 5W

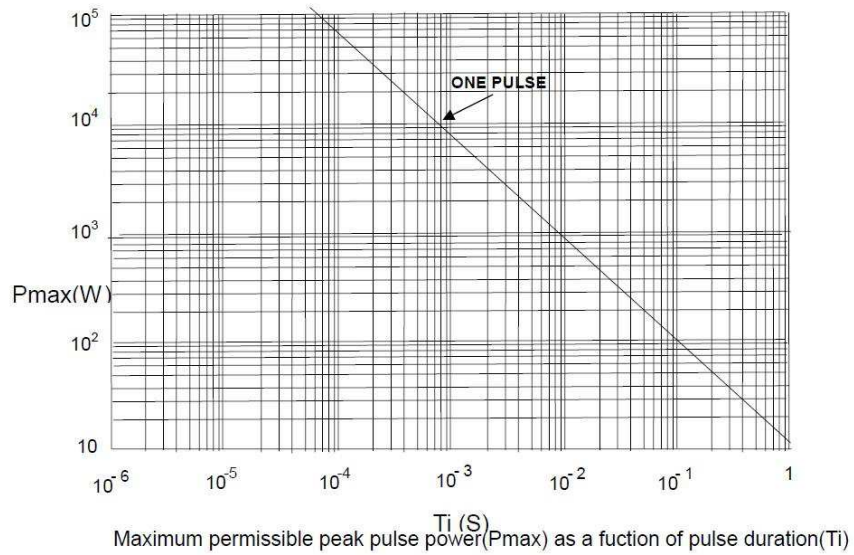

Condition test: Resistance change  $\leq \pm 5\%$  with pulse 1000 cycles as like the figure. (Reference Only)  
 1. Added power and added voltage are within the lower territory of this graph.  
 2. Added in normal temperature and humidity.

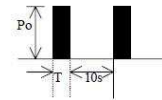

### SMF 5W

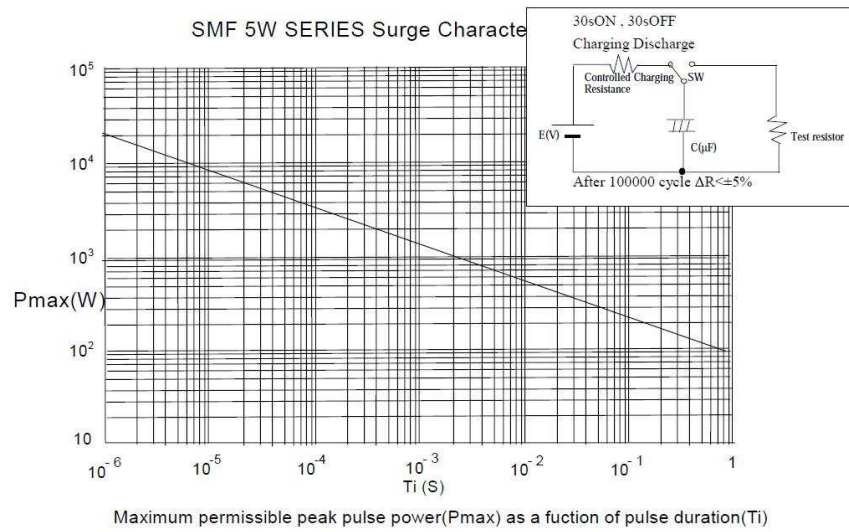

**SMW 7W**

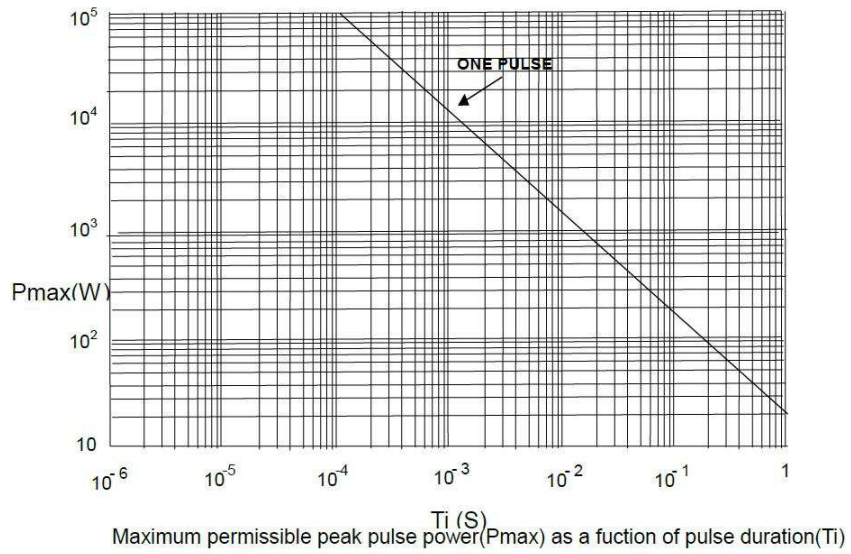

Condition test: Resistance change  $\leq \pm 5\%$  with pulse 1000 cycles as like the figure.(Reference Only)  
 1. Added power and added voltage are within the lower territory of this graph.  
 2. Added in normal temperature and humidity.

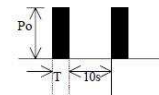

**SMF 7W**

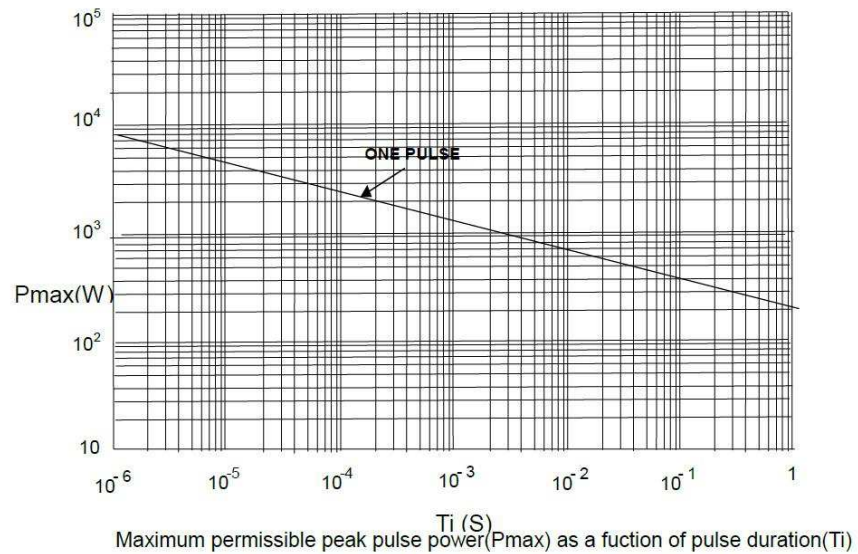

Condition test: Resistance change  $\leq \pm 5\%$  with pulse 1000 cycles as like the figure.(Reference Only)  
 1. Added power and added voltage are within the lower territory of this graph.  
 2. Added in normal temperature and humidity.

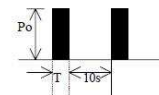

## Marking



## Packaging

### SM 2W – 5W

#### Reel

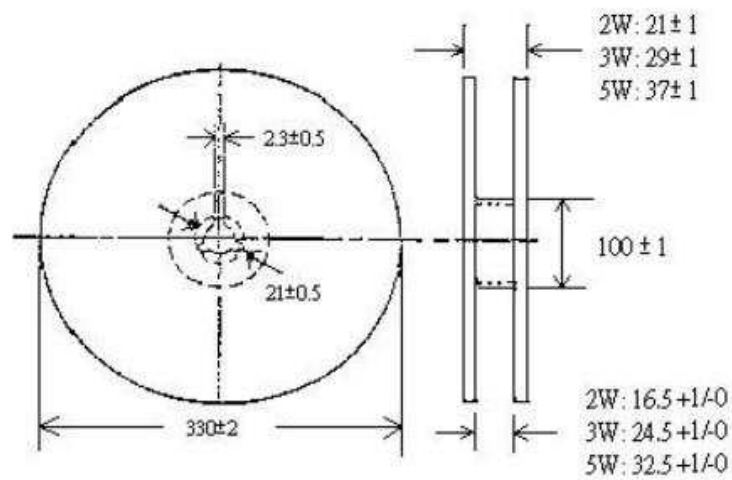

#### Tape

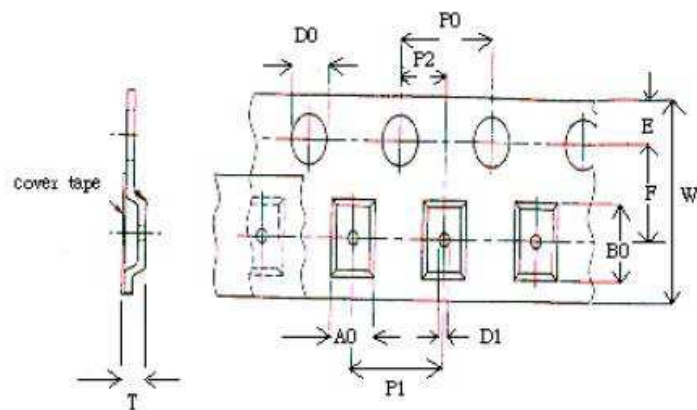

Rated Power	B0 ±	A0 ±	P1 ±	P2 ±	P0 ±	D0 ±	E ±	F ±	W ±	D1 ±	T ±	pcs/reel
	0.2	±0.2	±0.1	±0.1	±0.1	±0.1	0.1	0.1	0.3	±0.1	0.1	
2W	8	4.3	8	2	4	1.5	1.75	7.5	16	1.5	4.15	2000
3W	11.8	5.8	12	2	4	1.5	1.75	11.5	24	1.5	5.8	1000
5W	17.5	7.8	16	2	4	1.5	1.75	14.2	32	1.5	7.5	500



**SM 7W**

**Reel**

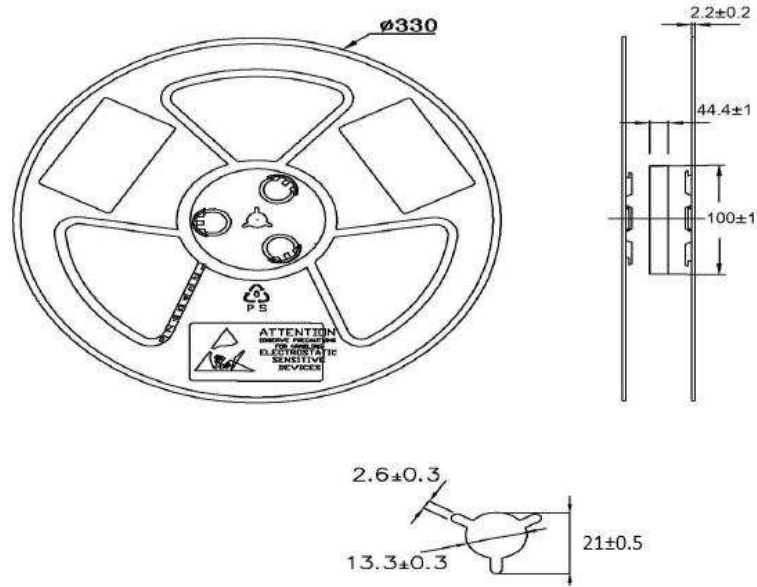

**Tape**

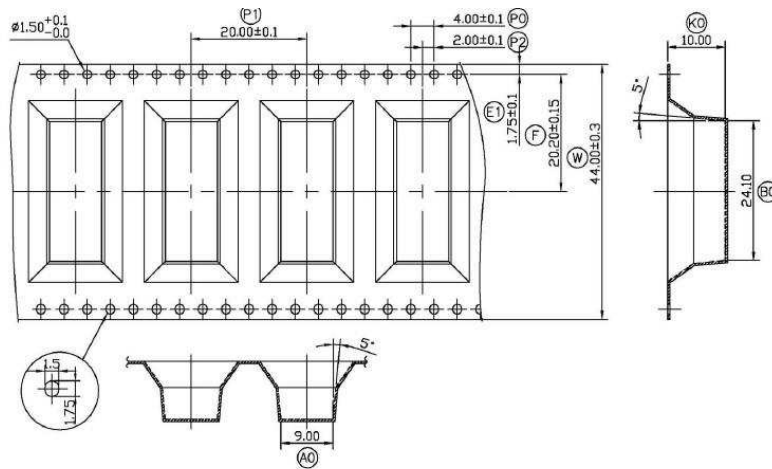

**How To Order**

SMF	3	10K	F	T
Common Part	Case size	Resistance value	Tolerance	Pack Style
SMW - Wirewound SMF - Metal Film	2 - 2 Watts 3 - 3 Watts 5 - 5 Watts 7 - 7 Watts	0.1 ohm (100 milli ohms) - R10 1 ohm -1R0 100 ohm -100R 1K ohm (1000 ohms) -1K0 100K ohm (100,000 ohms) - 100K	J - ±5% F - ±1%	T - Tape & Reel

## X-ON Electronics

Largest Supplier of Electrical and Electronic Components

*Click to view similar products for [Wirewound Resistors - SMD category:](#)*

*Click to view products by [TE Connectivity manufacturer:](#)*

Other Similar products are found below :

[RWS5 R22 F B](#) [WSM24R99FLFTR](#) [RWS5 R47 J B](#) [RWS5 R68 F B](#) [SMW5R11JT](#) [WSC2515365R0FTB](#) [RWS5 82R F B](#) [RWS5 120R F B](#)  
[RWS5 10R F B](#) [ACS-10S-15R-J](#) [SMW3300RJT](#) [RW7S0FB180RJET](#) [RW5S0FA470RJET](#) [RW7S0FB4K70JET](#) [RW7S0FB4K70FET](#) [RWS5](#)  
[1R J B](#) [RWS5 33R J B](#) [RWS1 50R F B](#) [PWR4318W1001JE](#) [PWR4318W4700JE](#) [PWR2010WR500FE](#) [PWR4318WR470JE](#)  
[QL0000J0220200](#) [QL0025J0470000](#) [QL0050J0102000](#) [QL0050J0362000](#) [QL0050J0470000](#) [QL0080J0470000](#) [R100W-10R](#) [R100W-22R](#)  
[R100W-470R](#) [R100W-4R7](#) [R200W-220R](#) [R200W-22R](#) [R200W-47R](#) [R50W-10R](#) [R50W-22R](#) [R50W-2R2](#) [R80W-10K](#) [R80W-47R](#)  
[SMW5R36JT](#) [SMW5R24JT](#) [SMW591RJT](#) [SMW52R4JT](#) [SMW513RJT](#) [SMW562RJT](#) [SMW5240RJT](#) [SMW51R6JT](#) [JW08](#) [RTS-01-100-](#)  
[100R-5-5/A](#)