

THIS DRAWING IS UNPUBLISHED. RELEASED FOR PUBLICATION
 © COPYRIGHT - By - ALL RIGHTS RESERVED.

LOC		DIST		REVISIONS			
P	LTR	DESCRIPTION		DATE	DWN	APVD	
AD	00	A3		REVISED PER ECO-11-004820	11MAR11	RK HMR	

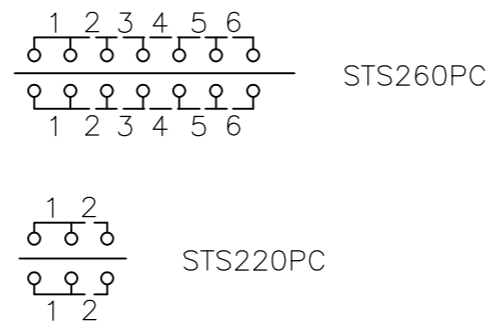
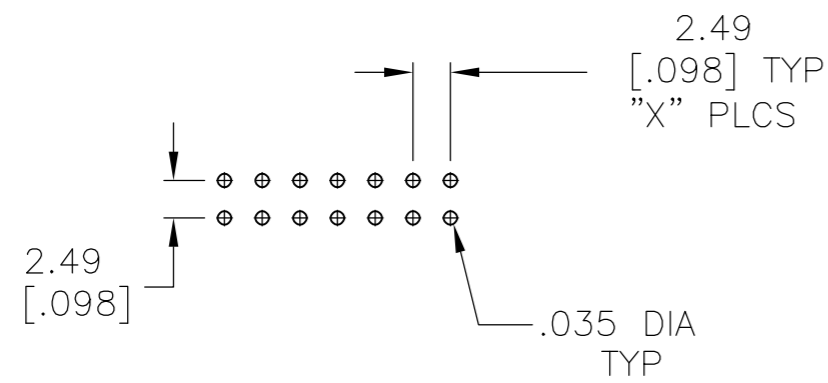
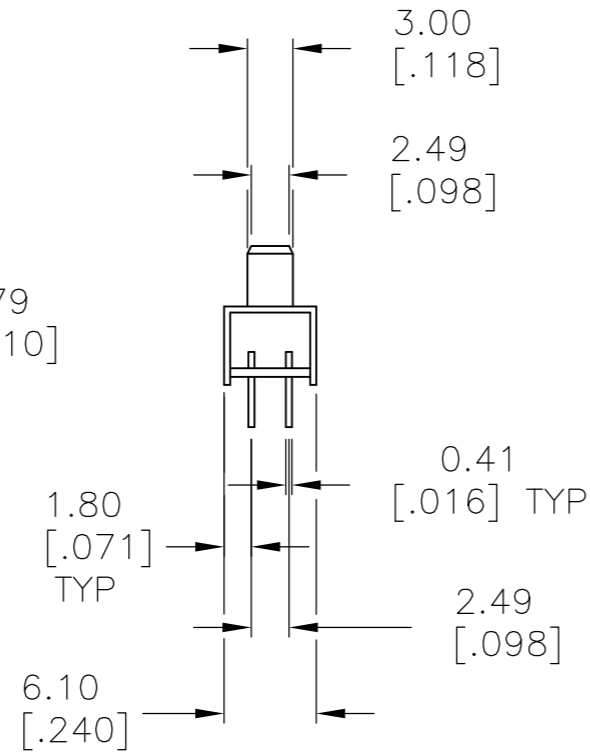
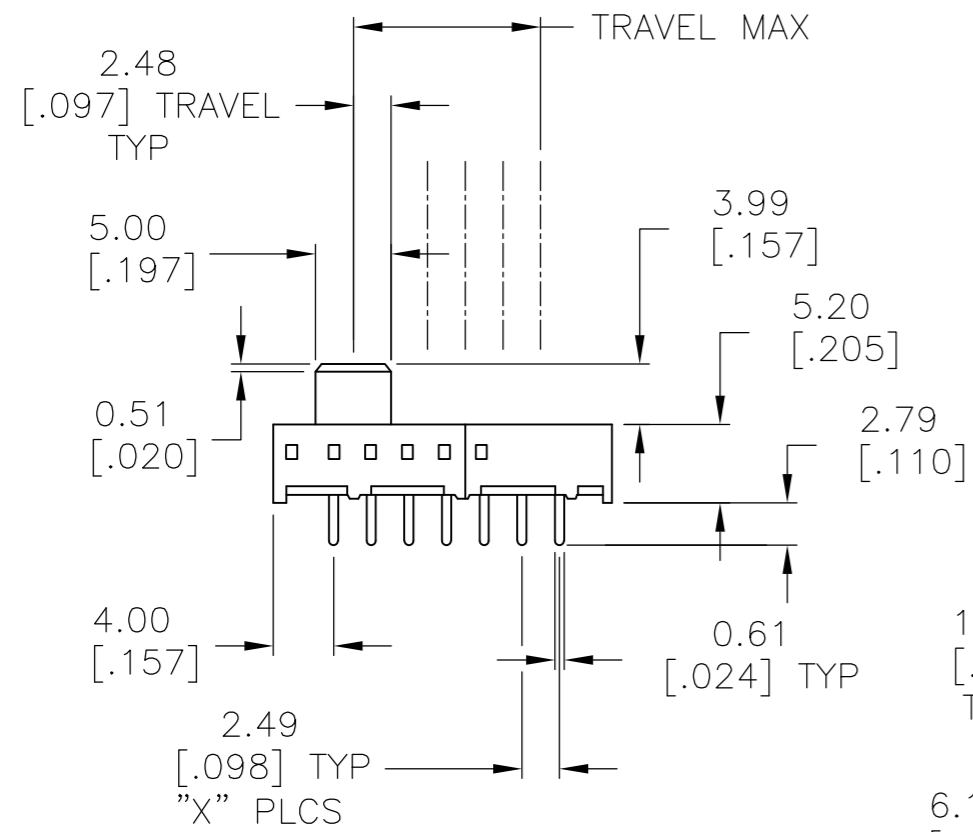
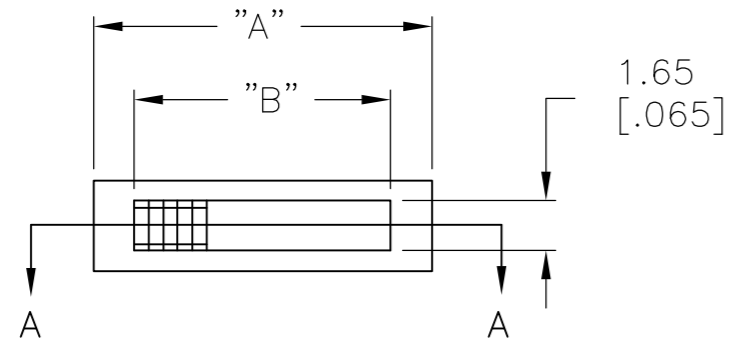

P.C. HOLE LAYOUT

EXAMPLES: MIN-MAX TRAVEL OF SWITCH

STS 260PC (DP6T)	23.00 [0.906]	17.50 [0.689]	6 PLCS
STS 250PC (DP5T)	20.50 [0.807]	15.00 [0.591]	5 PLCS
STS 240PC (DP4T)	18.00 [0.709]	12.50 [0.492]	4 PLCS
STS 230PC (DP3T)	15.50 [0.610]	10.00 [0.394]	3 PLCS
STS 220PC (DP2T)	13.00 [0.512]	7.50 [0.295]	2.50 [0.098]
PART IDENTIFICATION	A DIM	B DIM	X PLC

SPECIFICATIONS:
 MAKE-BEFORE-BREAK

MATERIALS:

FRAME: STEEL, ZINC PLATE
 ACTUATOR: POM UL94HB, BLACK
 FIXED CONTACT/TERMINAL: COPPER ALLOY, SILVER OVER NICKEL PLATE
 MOVING CONTACT: COPPER ALLOY, SILVER CLAD
 COIL SPRING: TEMPERED STEEL WIRE
 BALL- TEMPERED CARBON STEEL
 TERMINAL BOARD: PHENOLIC, UL94HB
 TERMINAL SEAL: EPOXY

ELECTRICAL:

CONTACT RATING: 250 MILLIAMPS@125V AC
 CONTACT RESISTANCE: 30 MILLIOHMS MAX (INITIAL), 60 MILLIOHMS AFTER TEST
 INSULATION RESISTANCE: 500 MEGOHMS MIN AT 500V DC
 DIELECTRIC STRENGTH: 500 VAC RMS AT SEA LEVEL
 LIFE EXPECTANCY: 10,000 CYCLES MIN. NO LOAD

MECHANICAL:

ACTION FORCE: 250 +150/-100 GRAMS
 TRAVEL: .098 (2.49MM)

ENVIRONMENTAL:

OPERATING TEMPERATURE: -10°C TO +60°C
 STORAGE TEMPERATURE: -10°C TO +60°C
 RESISTANCE TO SOLDER HEAT: 260°C FOR 10 SEC PER 109-202, COND. B
 SOLDERABILITY: PER EIA-364-56A, PROCEDURE 3, COND. B

NOTES:

- ALL MATERIALS AND FINISHES SHALL COMPLY WITH EU DIRECTIVE 2002/95/EC OF 27JAN2003 (ROHS)
- ALL PERFORMANCE SPECIFICATIONS WERE TESTED IN ACCORDANCE WITH JIS-C-5441 UNLESS OTHERWISE STATED.

6	17.50 [0.689]	23.00 [0.906]	DP6T	STS260PC04	1825163-5
5	15.00 [0.591]	20.50 [0.807]	DP5T	STS250PC04	1825163-4
4	12.50 [0.492]	18.00 [0.709]	DP4T	STS240PC04	1825163-3
3	10.00 [0.394]	15.50 [0.610]	DP3T	STS230PC04	1825163-2
2	7.50 [0.295]	13.00 [0.512]	DPDT	STS220PC04	1825163-1
X PLC	DIM B	DIM A	FUNCTION	T&B P/N	PART NO.

THIS DRAWING IS A CONTROLLED DOCUMENT.		DWN B.S.VISWESWARA 31MAR05	TE Connectivity		
DIMENSIONS: mm [INCHES]		CHK M S SARVER			
TOLERANCES UNLESS OTHERWISE SPECIFIED:		APVD M S SARVER	NAME SWITCH-SLIDE (DP*T) P/N STS2*0PC		
0 PLC ± - 1 PLC ± - 2 PLC ± .008(0.20) 3 PLC ± - 4 PLC ± - ANGLES ± 1°		PRODUCT SPEC -	RESTRICTED TO		
MATERIAL -		FINISH -	WEIGHT -	SIZE A2	CAGE CODE 00779
		CUSTOMER DRAWING		DRAWING NO C=1825163	SCALE 2:1
				SHEET 1 of 2	REV A3

THIS DRAWING IS UNPUBLISHED. RELEASED FOR PUBLICATION
 © COPYRIGHT - By - ALL RIGHTS RESERVED.

LOC	DIST	REVISIONS			
P	LTR	DESCRIPTION	DATE	DWN	APVD
AD	00	SEE SHEET 1	-	-	-

PART NUMBER POSITION BOTTOM VIEW

-1

2

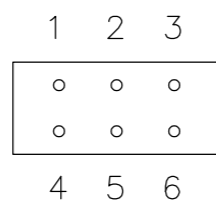

FUNCTION DIAGRAM

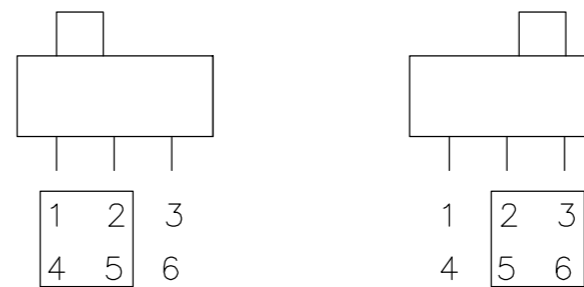

-2

3

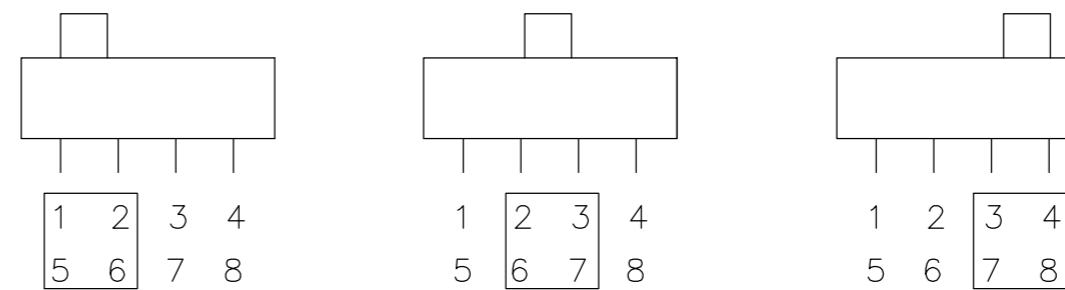
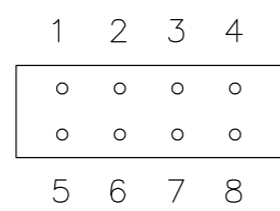

-3

4

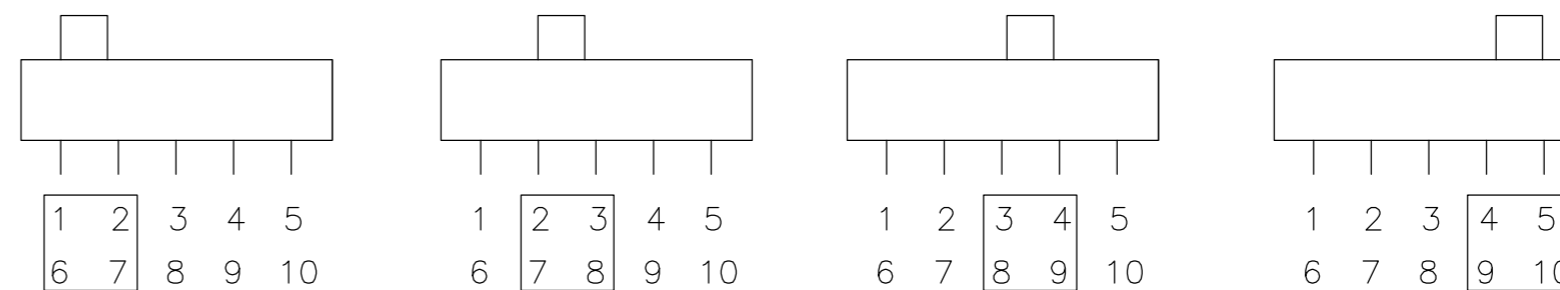
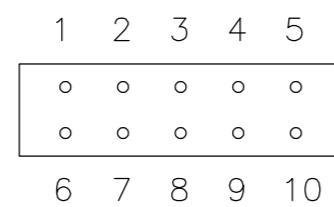

-4

5

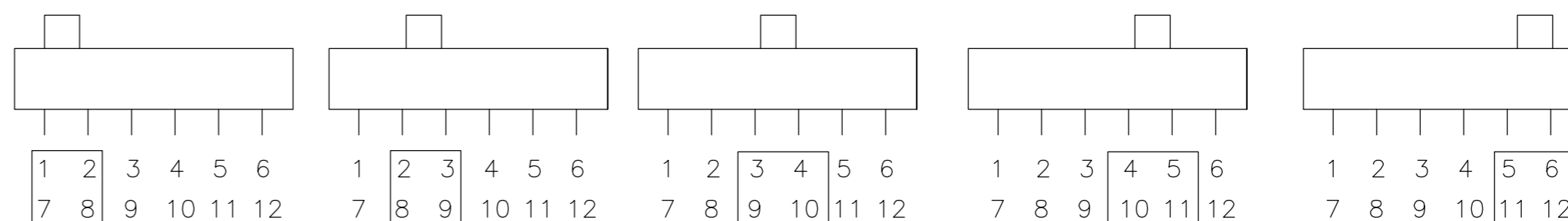
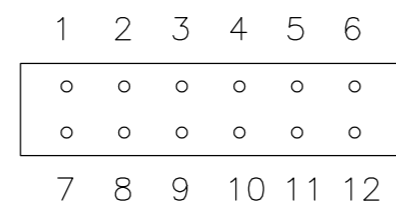

-5

6

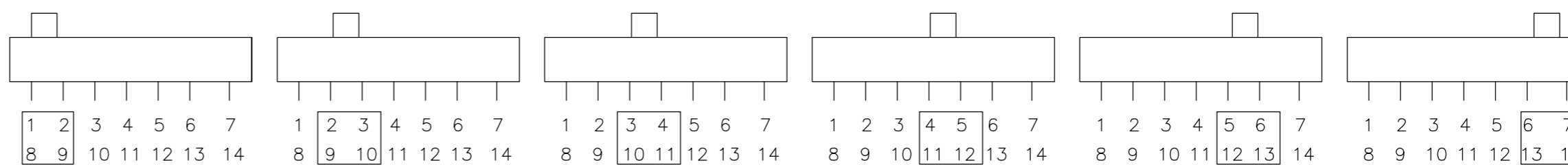

THIS DRAWING IS A CONTROLLED DOCUMENT.		DWN B.S.VISWESWARA 31MAR05		
DIMENSIONS: mm [INCHES]		CHK M S SARVER		
TOLERANCES UNLESS OTHERWISE SPECIFIED: 0 PLC ± - 1 PLC ± - 2 PLC ± .008(0.20) 3 PLC ± - 4 PLC ± - ANGLES ± 1°		APVD M S SARVER	NAME SWITCH-SLIDE (DP*T) P/N STS2*0PC	
MATERIAL		FINISH	WEIGHT	SIZE A2
				CAGE CODE 00779
				DRAWING NO 1825163
				RESTRICTED TO
				SCALE 2:1
				SHEET 2 OF 2
				REV A3
				CUSTOMER DRAWING

X-ON Electronics

Largest Supplier of Electrical and Electronic Components

Click to view similar products for [Slide Switches](#) category:

Click to view products by [TE Connectivity](#) manufacturer:

Other Similar products are found below :

[6-1437581-1](#) [M43R](#) [MHSS1104A](#) [MMD](#) [GH36W010001](#) [GH49S010001](#) [1437576-8](#) [EPS1PC1](#) [1825074-1](#) [1825160-3](#) [1825167-2](#)
[25139NLDB](#) [25449NAH](#) [L101011ML04B](#) [SLB1240R45](#) [SLSA12004](#) [1825078-1](#) [1825080-4](#) [1825081-1](#) [1825269-1](#) [1825270-2](#)
[STS141RA04](#) [T2215BEN506](#) [GF-124-0204](#) [GH46P000001](#) [GH46W000001](#) [GH49P010001](#) [25339NA](#) [25436NLDH](#) [CST91246FK](#)
[TG36P000000](#) [TG36P000050](#) [47227LFE](#) [49331L](#) [MHSS1105A](#) [50208L](#) [L202091MS02Q](#) [4-1437581-7](#) [X2225CR-437W](#) [48BFSP3M2QT](#)
[49329L](#) [1101M1S3ZB8E2](#) [1-1437581-1](#) [EG1218REDACTUATOR](#) [TG39W000000](#) [1825075-1](#) [TG36WS80065](#) [T105S1CWZBE](#)
[SLB1280R5](#) [25136NLDB](#)