

THIS DRAWING IS UNPUBLISHED.

RELEASED FOR PUBLICATION

20

© COPYRIGHT 20 BY -

ALL RIGHTS RESERVED.

REVISIONS

P	LTR	DESCRIPTION	DATE	DWN	APVD
A2		ECR-16-007959	13JUN2016	RL	CW
A3		ECR-16-017508	13DEC2016	RL	CW
B		ECR-18-005861	03AUG2018	YC	CW
C		ECR-21-122216	09DEC2021	WQR	CW

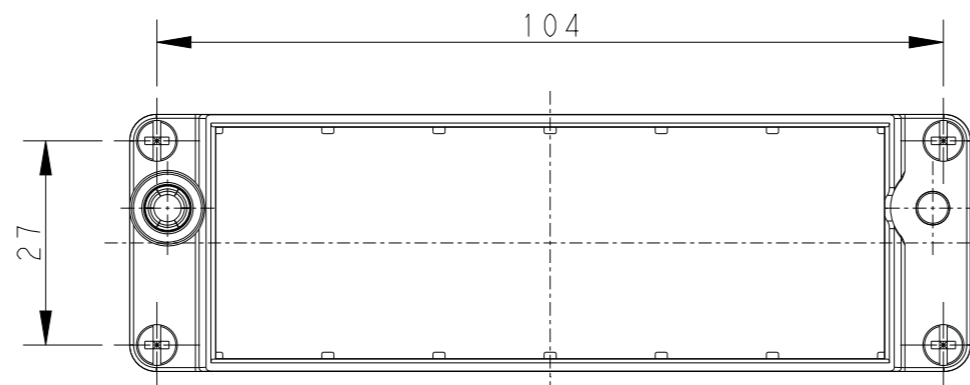
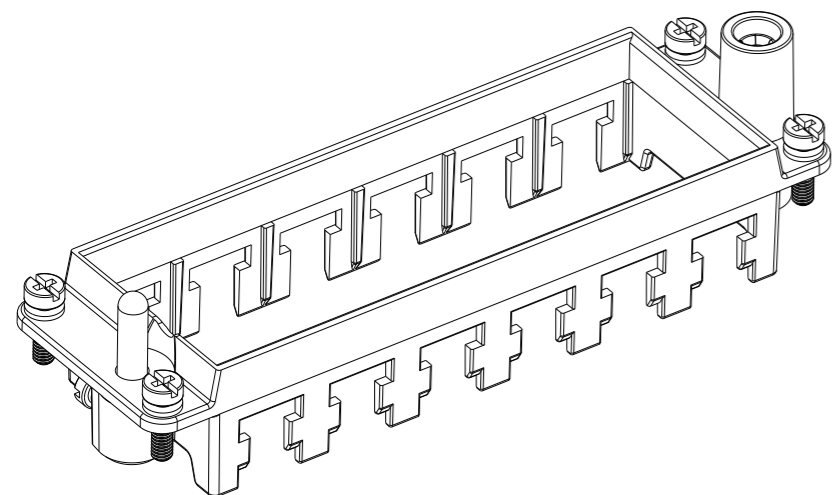

NOTES:

- 1. TECHNICAL CHARACTERISTICS:
 FRAME MATERIAL: DIE CAST ZINC ALLOY
 NUMBER OF MODULES: 6
 SURFACE: ZINC PLATED
 MATING CYCLES: 500 CYCLES

注释:

- 1. 技术参数:
 框架材料: 锌合金
 模块数量: 6
 表面处理: 镀锌
 插拔次数: 500次

4X M3 SCREW
 RECOMMENDED TIGHTENING TORQUE 0.5Nm
 4X M3 螺丝推荐锁紧力矩为0.5Nm

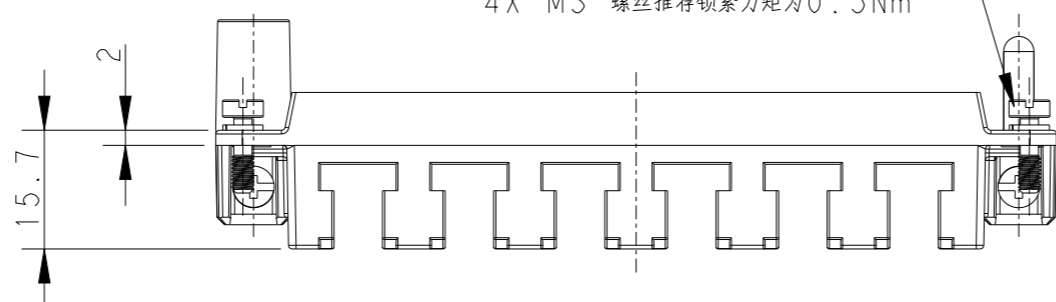
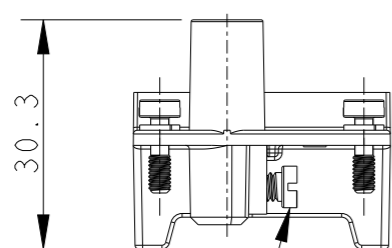

2X M4 SCREW, RECOMMENDED TIGHTENING TORQUE 1.2Nm
 2X M4 螺丝, 推荐锁紧力矩为1.2Nm

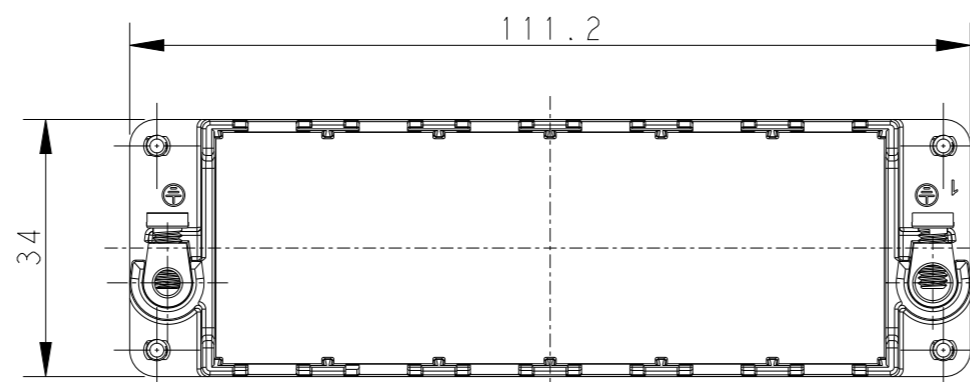

PANEL CUT FOR FRAME USE WITHOUT HOODS/ HOUSINGS

T2070244001-000 SHOWN ABOVE WITHOUT MARK
 T2070244001-000, 不带标记

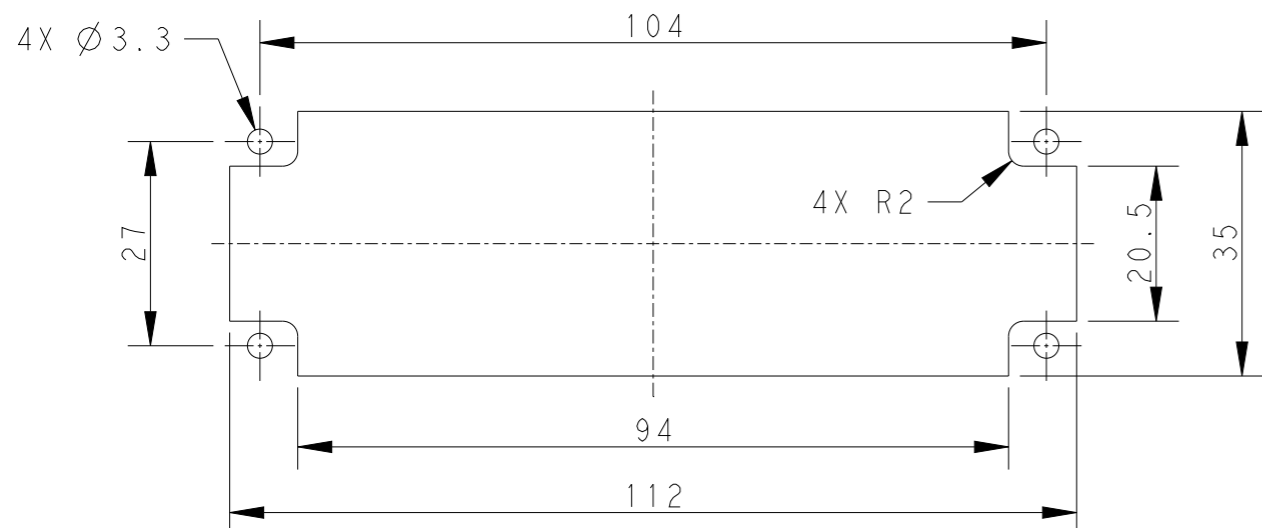

T2070244001-000	H24BN-T6	H24BN MODULE FRAME H24BN模块框架
T2070244101-000	H24BN-T6-M	H24BN MALE MODULE FRAME H24BN模块公框架
T2070244201-000	H24BN-T6-F	H24BN FEMALE MODULE FRAME H24BN模块母框架
T2070244101-001	H24BN-T6-M	H24BN MALE MODULE FRAME, MARK, NO LOGO H24BN模块公框架带标记, 不带LOGO
T2070244201-001	H24BN-T6-F	H24BN FEMALE MODULE FRAME, MARK, NO LOGO H24BN模块母框架带标记, 不带LOGO
PART NUMBER 料号		PART DESCRIPTION 描述

THIS DRAWING IS A CONTROLLED DOCUMENT.

DIMENSIONS:	TOLERANCES UNLESS OTHERWISE SPECIFIED:
mm	
0 PLC	±-
1 PLC	±-
2 PLC	±-
3 PLC	±-
4 PLC ANGLES	±-
FINISH	
MATERIAL	

DWN	28FEB2015
DAVID WANG	
CHK	28FEB2015
CHRIS WANG	
APVD	28FEB2015
XIANG XU	
PRODUCT SPEC	108-137057
APPLICATION SPEC	114-137057
WEIGHT	-
Customer Drawing	

 TE Connectivity		NAME		H24BN-T6	
		SIZE	CAGE CODE	DRAWING NO	RESTRICTED TO
A3	-	©-T2070244001000	-		
SCALE		1:1	SHEET	1 OF 3	REV
					C

REVISIONS

P	LTR	DESCRIPTION	DATE	DWN	APVD
-	-	SEE SHEET 1	-	-	-

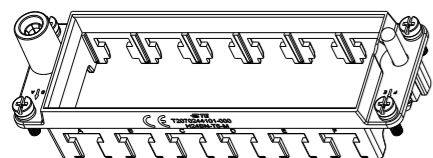

SCALE 1:2

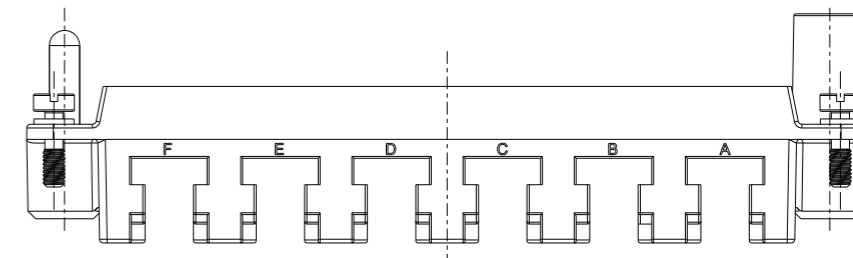
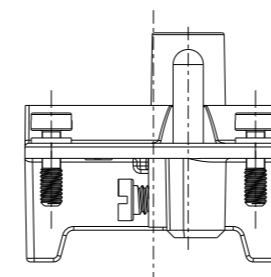
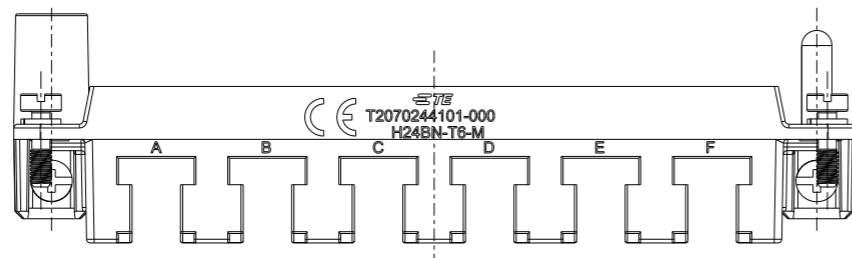
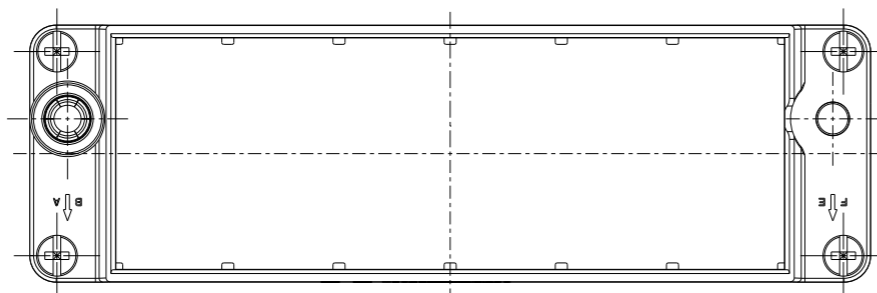

T2070244101-000, H24BN-T6-M SHOWN
 WITH MARK, ALL DIMENSIONS THE SAME TO T2070244001-000
 T2070244101-000, H24BN-T6-M, 带标记, 所有尺寸同T2070244001-000一样

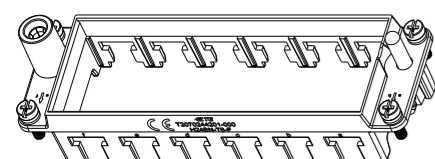

SCALE 1:2

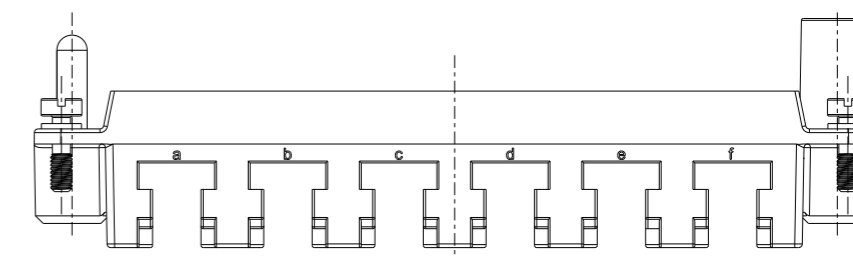
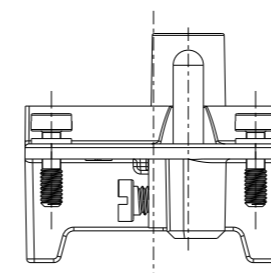
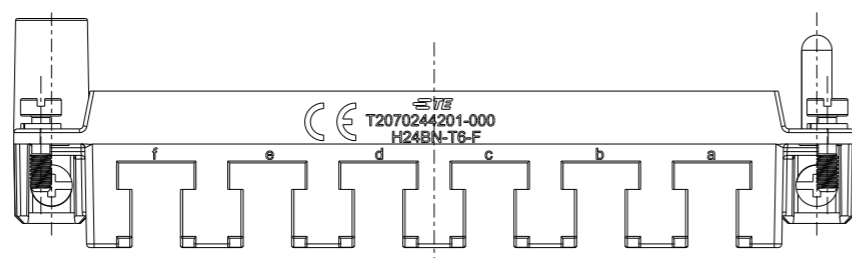
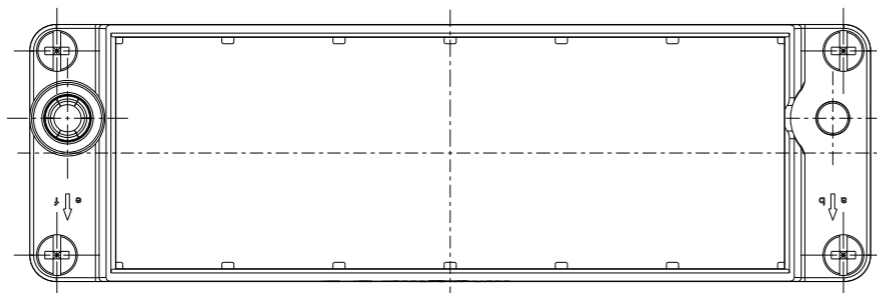

T2070244201-000, H24BN-T6-F SHOWN
 WITH MARK, ALL DIMENSIONS THE SAME TO T2070244001-000
 T2070244201-000, H24BN-T6-F, 带标记, 所有尺寸同T2070244001-000一样

THIS DRAWING IS A CONTROLLED DOCUMENT.

DIMENSIONS:	TOLERANCES UNLESS OTHERWISE SPECIFIED:
mm	0 PLC ±-
	1 PLC ±-
	2 PLC ±-
	3 PLC ±-
	4 PLC ±-
	ANGLES ±-
MATERIAL	FINISH
-	-
-	-

DWN	28FEB2015
DAVID WANG	
CHK	28FEB2015
CHRIS WANG	
APVD	28FEB2015
XIANG XU	
PRODUCT SPEC	108-137057
APPLICATION SPEC	114-137057
WEIGHT	-
Customer Drawing	

TE Connectivity		NAME		RESTRICTED TO
		H24BN-T6		
SIZE	CAGE CODE	DRAWING NO	-	
A3	-	©-T2070244001000	-	
SCALE		SHEET	OF	REV
1:1		2	3	C

REVISIONS

P	LTR	DESCRIPTION	DATE	DWN	APVD
-		SEE SHEET 1	-	-	-

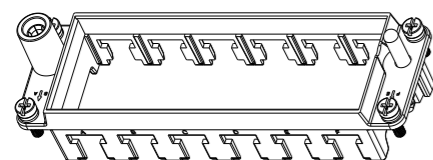

SCALE 1:2

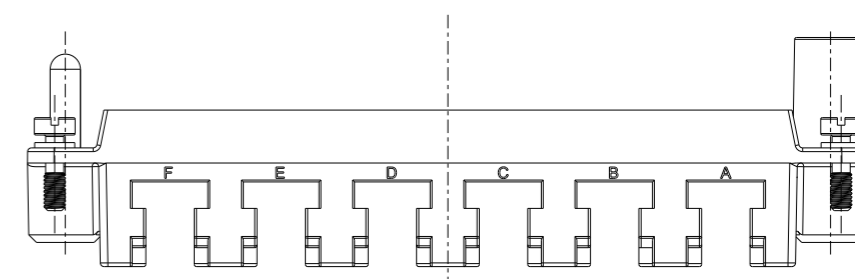
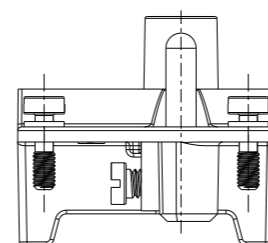
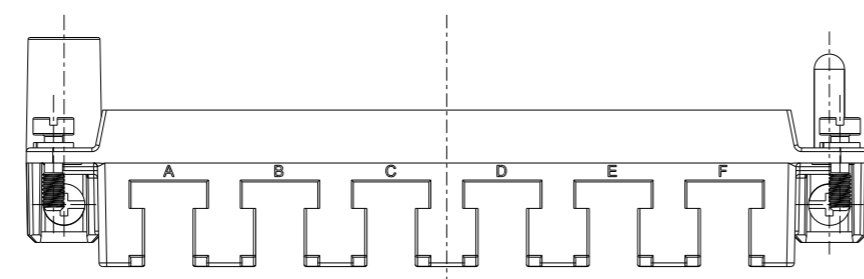
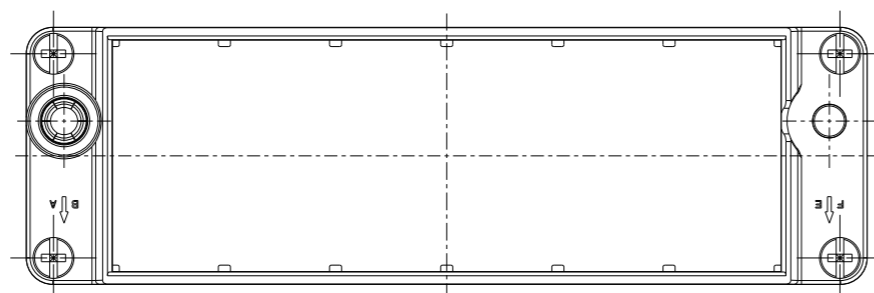

T2070244101-001, H24BN-T6-M SHOWN WITH MARK,
 WITHOUT LOGO, ALL DIMENSIONS THE SAME TO T2070244001-000
 T2070244101-001, H24BN-T6-M, 带标记, 不带LOGO, 所有尺寸同T2070244001-000一样

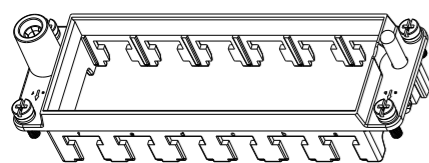

SCALE 1:2

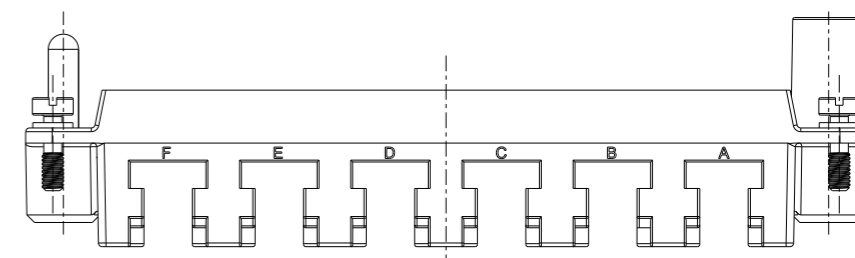
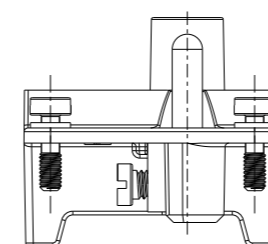
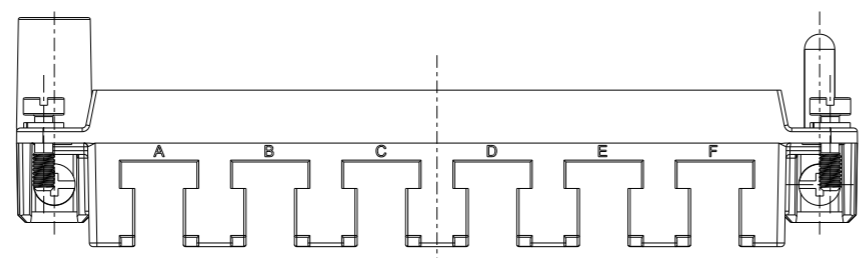
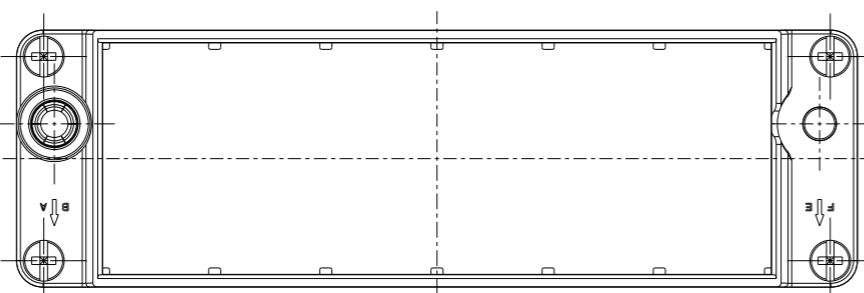

T2070244201-001, H24BN-T6-F SHOWN WITH MARK,
 WITHOUT LOGO, ALL DIMENSIONS THE SAME TO T2070244001-000
 T2070244201-001, H24BN-T6-F, 带标记, 不带LOGO, 所有尺寸同T2070244001-000一样

THIS DRAWING IS A CONTROLLED DOCUMENT.

DIMENSIONS:

mm

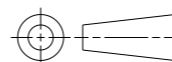

TOLERANCES UNLESS OTHERWISE SPECIFIED:

- 0 PLC ±-
- 1 PLC ±-
- 2 PLC ±-
- 3 PLC ±-
- 4 PLC ±-
- ANGLES ±-
- FINISH -

MATERIAL

-

DWN 28FEB2015

DAVID WANG

CHK 28FEB2015

CHRIS WANG

APVD 28FEB2015

XIANG XU

PRODUCT SPEC

108-137057

APPLICATION SPEC

114-137057

WEIGHT

-

CUSTOMER DRAWING

NAME H24BN-T6



TE Connectivity

SIZE	CAGE CODE	DRAWING NO	RESTRICTED TO
------	-----------	------------	---------------

A3	-	©-T2070244001000	-
----	---	------------------	---

SCALE	SHEET	OF	REV
-------	-------	----	-----

1:1	3	3	C
-----	---	---	---

X-ON Electronics

Largest Supplier of Electrical and Electronic Components

Click to view similar products for [Heavy Duty Power Connectors](#) category:

Click to view products by [TE Connectivity](#) manufacturer:

Other Similar products are found below :

[647757-1](#) [6643411-1](#) [6646058-2](#) [6646137-1](#) [6646138-1](#) [6646479-1](#) [6646608-1](#) [6646786-1](#) [6646940-1](#) [6651091-1](#) [6651525-1](#) [6651529-1](#)
[6651788-1](#) [696475-1](#) [702-32-01109](#) [703-25-02205](#) [73000005059](#) [73000005642](#) [73080255059](#) [73080965046](#) [765-15-0080A](#) [765-16-0080B](#)
[765-18-0080D](#) [829992-1](#) [902-77-02113](#) [PS00/A0620/6300](#) [PS25/A0420/63](#) [129-1J](#) [1409400](#) [AN0024023](#) [E6374G1](#) [e6389g2](#) [157-43GW8](#)
[MS3117-14AC](#) [1643543-1](#) [1650540-1](#) [1651811-2](#) [1766260-1](#) [1766282-1](#) [1766966-1](#) [1791340000](#) [NLDFT-3-BL-L-S120-M40A](#) [NLDFT-N-](#)
[W-L-C240-M40B](#) [NLS-2-R-C240-M40B](#) [NLS-N-W-C240-M40B](#) [NPS-3-BL-T6](#) [1986615-1](#) [2-1589900-8](#) [2199314-1](#) [KA8102](#)