

P	LTR	DESCRIPTION	DATE	DWN	APVD
	A	INITIAL	15NOV2019	DW	CW
	A1	ECR-20-008707	29JUN2020	DW	CW
	B	ECR-21-111798	07OCT2021	WQR	CW

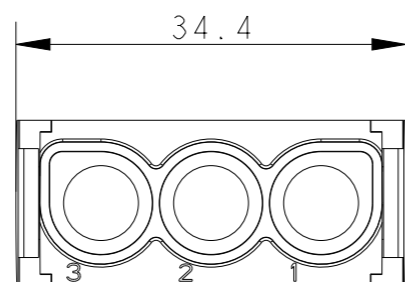
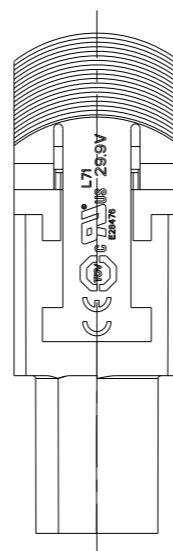
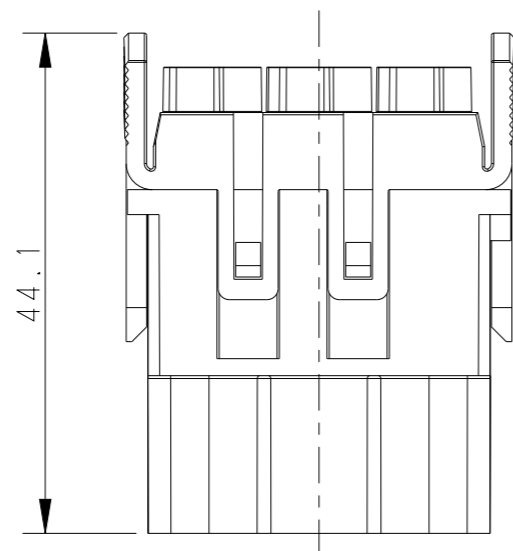
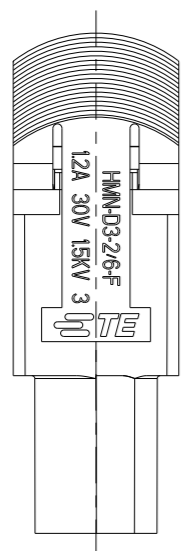
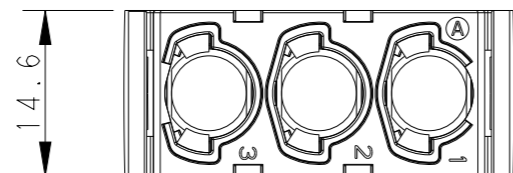
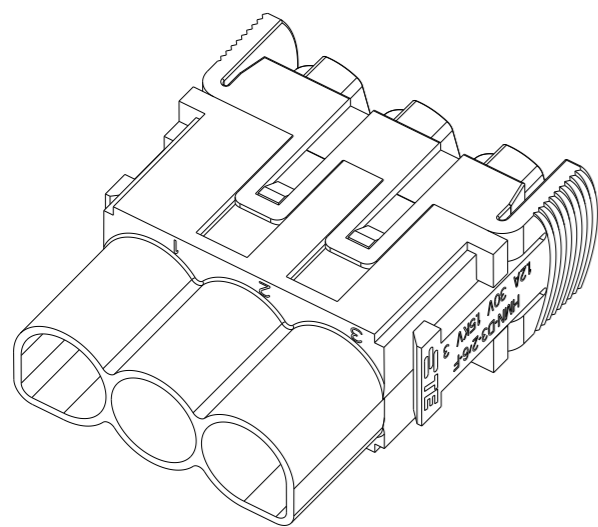

NOTES:

- TECHNICAL CHARACTERISTICS:
 INSULATION MATERIAL: PC
 RATED VOLTAGE: 30V
 RATED CURRENT: 1.2A
 INSULATION RESISTANCE: $\geq 400M\Omega$
 RATED IMPULSE VOLTAGE: 1.5KV
 POLLUTION DEGREE: 3
 FLAMMABILITY: UL94V-0
 MATING CYCLES: 500 CYCLES
 TEMPERATURE RANGE: -20~+125°C
 WIRE RANGE: FOR 210 DATE: 0.14~1.0 mm² (26~18 AWG)
 FOR 606 DATE: 0.08~0.34 mm² (28~22 AWG)
 CONTACT TYPE: CRIMP CONTACT
- DATA ELEMENT NEED TO BE ORDERED SEPARATELY.
 (ORDER No. REFER TO PARTS:
 FOR 210 DATE: 40.A711.00 + 60.279.11;
 FOR 606 DATE: 40.A702.00 + 60.278.11)

注释:

- 技术参数:
 绝缘材料: PC
 额定电压: 30V
 额定电流: 1.2A
 绝缘电阻: $\geq 400M\Omega$
 额定脉冲电压: 1.5KV
 污染等级: 3
 阻燃等级: UL94V-0
 插拔次数: 500次
 温度范围: -20~+125°C
 接线范围: 210数据传输模块: 0.14~1.0 mm² (26~18 AWG)
 606数据传输模块: 0.08~0.34 mm² (28~22 AWG)
 接线类型: 冷压接
- 数据传输模块需要单独订购。
 (订货号参考: 210数据传输模块: 40.A711.00 + 60.279.11
 606数据传输模块: 40.A702.00 + 60.278.11)

T2115032201-000	HMN-D3-2/6-F	HMN-D3-2/6 FEMALE MODULE INSERT HMN-D3-2/6 模块母插
PART NUMBER 料号	PART DESCRIPTION 描述	

THIS DRAWING IS A CONTROLLED DOCUMENT.		DWN 12JUL2019 DAVID WANG	 TE Connectivity NAME HMN-D3-2/6-F
DIMENSIONS: mm		CHK 12JUL2019 GINO YAO	
TOLERANCES UNLESS OTHERWISE SPECIFIED:		APVD 12JUL2019 CHRIS WANG	
0 PLC ±- 1 PLC ±- 2 PLC ±- 3 PLC ±- 4 PLC ±- ANGLES ±-		PRODUCT SPEC 108-137419	
MATERIAL		APPLICATION SPEC 114-137419	RESTRICTED TO
		WEIGHT	SIZE CAGE CODE DRAWING NO A300779 C-T2115032201000
		RESTRICTED CUSTOMER	SCALE SHEET OF REV 3:2 1 OF 1 B

X-ON Electronics

Largest Supplier of Electrical and Electronic Components

Click to view similar products for [Heavy Duty Power Connectors](#) category:

Click to view products by [TE Connectivity](#) manufacturer:

Other Similar products are found below :

[647757-1](#) [6643411-1](#) [6646058-2](#) [6646137-1](#) [6646138-1](#) [6646479-1](#) [6646608-1](#) [6646786-1](#) [6646940-1](#) [6651091-1](#) [6651525-1](#) [6651529-1](#)
[6651788-1](#) [696475-1](#) [702-32-01109](#) [703-25-02205](#) [73000005059](#) [73000005642](#) [73080255059](#) [73080965046](#) [765-15-0080A](#) [765-16-0080B](#)
[765-18-0080D](#) [829992-1](#) [902-77-02113](#) [PS00/A0620/6300](#) [PS25/A0420/63](#) [129-1J](#) [1409400](#) [AN0024023](#) [E6374G1](#) [e6389g2](#) [157-43GW8](#)
[MS3117-14AC](#) [1643543-1](#) [1650540-1](#) [1651811-2](#) [1766260-1](#) [1766282-1](#) [1766966-1](#) [1791340000](#) [NLDFT-3-BL-L-S120-M40A](#) [NLDFT-N-](#)
[W-L-C240-M40B](#) [NLS-2-R-C240-M40B](#) [NLS-N-W-C240-M40B](#) [NPS-3-BL-T6](#) [1986615-1](#) [2-1589900-8](#) [2199314-1](#) [KA8102](#)