

T90 Series, 30A PCB Relay

- 30A, 1 form A (NO); 20A, 1 form C (CO)
- Available as open frame or sealed construction
- Meets UL 508 and 873 Spacing - 3.18 through air, 6.36 over surface
- UL class F insulation system standard

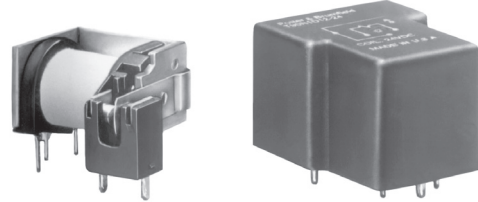

Typical applications
HVAC, Appliances, Industrial Controls.

Approvals

UL E22575; CSA LR15734
Technical data of approved types on request.

Contact Data

Contact arrangement	1 form A (NO), 1 form B (NC), 1 form C (CO)
Rated voltage	277VAC
Max. switching voltage	277VAC
Rated current	30A
Limiting continuous current	30A
Limiting making current	30A
Limiting breaking current	30A
Contact material	AgCdO
Min. recommended contact load	1A, 5VDC or 12VAC
Initial contact resistance	75 mΩ at 1A at 5VDC or 12VAC
Frequency of operation, with load	360hr
Operate/release time max., including bounce	15/15ms

Contact ratings

Type	Load	Cycles
Typical		
AgCdO, open style relay		
NO	30A, 240VAC, general purpose	100x10 ³
NO	20A, 240VAC, resistive heater	100x10 ³
CO	20A/10A, 240VAC, general purpose	100x10 ³
CO	20A/10A, 28VDC, resistive	100x10 ³

UL 508/873

Type	Load	Cycles
AgCdO		
NO	30A, 240VAC, general purpose	100x10 ³
NC	15A, 240VAC, general purpose	100x10 ³
CO	20A/10A, 240VAC, general purpose	100x10 ³
NO	20A, 240VAC, resistive	100x10 ³
NC	15A, 240VAC, resistive	100x10 ³
CO	20A/10A, 240VAC, resistive	100x10 ³
NO	80LRA/30FLA, 240VAC	30x10 ³
NC	30LRA/10FLA, 240VAC	30x10 ³
CO	53.6LRA/20FLA / 20LRA/6.7FLA, 240VAC	100x10 ³
NO	98LRA/22FLA, 120VAC	100x10 ³
NO	2HP, 240VAC	1x10 ³
NC	1/2HP, 240VAC	1x10 ³
NO	1HP, 120VAC	1x10 ³
NC	1/4HP, 120VAC	1x10 ³
NO	6A, 277VAC, ballast	100x10 ³
NC	3A, 277VAC, ballast	6x10 ³
NO	TV5, 240VAC, tungsten	6x10 ³
NC	TV3, 240VAC, tungsten	6x10 ³
NO	20A, 28VDC, resistive	100x10 ³
NC	10A, 28VDC, resistive	100x10 ³

All ratings at 25°C (unless otherwise noted) with relay properly vented. Remove vent nib from enclosed relays after soldering and cleaning for optimum life.

Mechanical endurance 10x10⁶ ops.

Coil Data

Coil voltage range	5 to 110VDC
Max. coil power	1.0W
Max. coil temperature	155°C
Coil insulation system according UL	Class F

Coil versions, DC coil

Coil code	Rated voltage VDC	Operate voltage VDC	Release voltage VDC	Coil resistance Ω±10%	Rated coil power W
5	5	3.75	0.5	27	900
6	6	4.5	0.6	40	900
9	9	6.75	0.9	97	900
12	12	9	1.2	155	900
18	18	13.5	1.8	380	900
24	24	18	2.4	660	900
48	48	36	4.8	2560	900
110	110	82.5	11	13450	900

All figures are given for coil without preenergization, at ambient temperature +23°C.

Ambient temperature vs. coil voltage - 1W coil

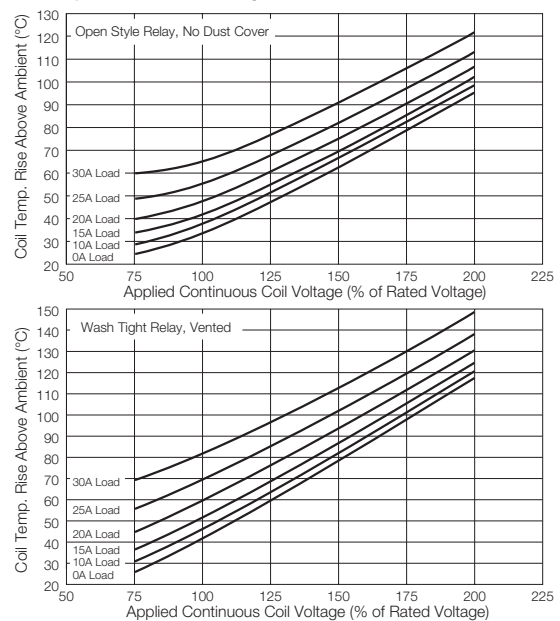

Data graphed above are average values and should be verified in application. Tests were conducted within a 2' (.6m) cube (still air); at nominal coil power @ 25°C; with normally open contact loaded; and with 4' (1.22m) long, #10AWG load wires. P.C. board relays were mounted to a 30A, single side P.C. board. Coil rise test conducted with a 30A PC board to maintain 20°C max. rise at 30°C. The relay connections and wiring must be designed with an adequate cross section to ensure proper current flow and heat dissipation. After cleaning process knock-off nib should be removed for optimum life of wash-tight relays.

T90 Series, 30A PCB Relay (Continued)

Insulation Data

Initial dielectric strength	
between open contacts	1500V _{rms}
between contact and coil	1500V _{rms}
Initial insulation resistance	
between insulated elements	1x10 ⁹ Ω
Clearance/creepage	
between contact and coil	3.17mm

Other Data

Material compliance: EU RoHS/ELV, China RoHS, REACH, Halogen content refer to the Product Compliance Support Center at www.te.com/customersupport/rohssupportcenter

Ambient temperature	
DC coil	-55°C to 85°C ¹⁾
Category of environmental protection	
IEC 61810	RT0 - open, RTIII - wash tight

Other Data (continued)

Vibration resistance (functional)	1.65mm max excursions, 10-55 Hz
Shock resistance (functional)	10g for 11msec
Shock resistance (destructive)	100g
Terminal type	PCB-tht
Weight	20g open relay 26g wash-tight relay
Resistance to soldering heat THT	
IEC 60068-2-20	250°C
Packaging/unit	tray/50 pcs., box/500 pcs.

1) Operating ambient temperature must consider "Must Operate Voltage Change Over Temperature," Contact Temperature Rise, Coil Temperature Rise (if coil is not allowed to cool) and Maximum Coil Temperature. Specification ambient considers 20A load with coil cooled to ambient.

Dimensions

T90N

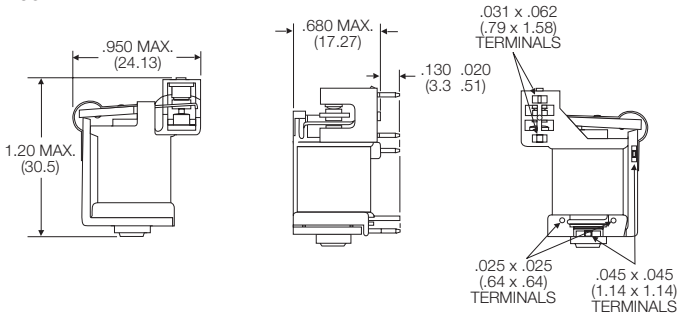

T90S

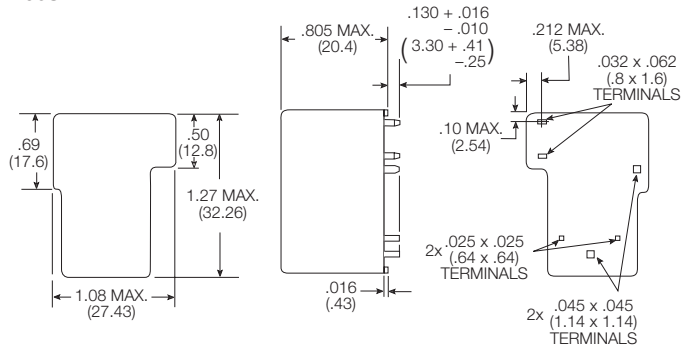

Terminal assignment

Bottom view on pins

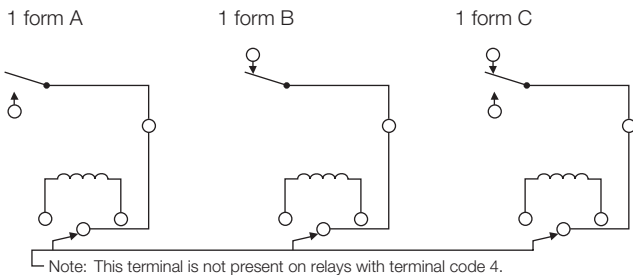

PCB layout

Bottom view on pins

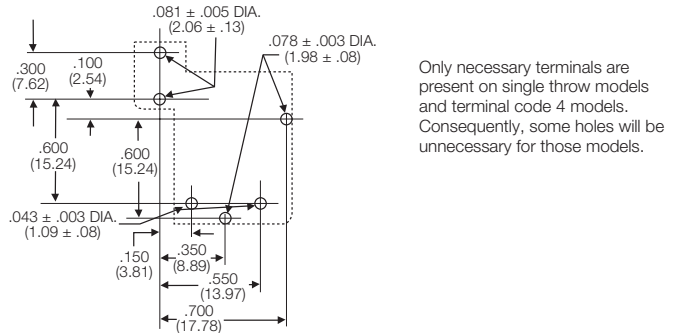

Accessory

Optional plastic dust cover is a snap-on unit, open on the PC board side of the relay. The cover, when ordered with the relay, is shipped separately. It is designed to be snapped into place by the customer after the relay has been assembled to the PC board.

Product Code	Description	Part Number
35C620A	Black dust cover, for use on T90N relay	4-1393209-2

35C620A

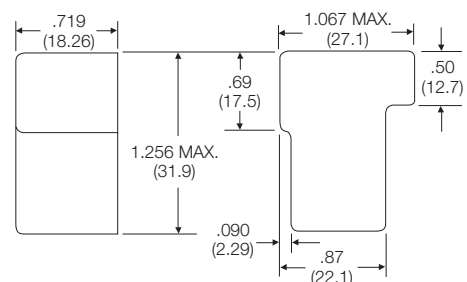

T90 Series, 30A PCB Relay (Continued)

Product code structure		Typical product code		T90	S	5	D	1	2	-24
Type		T90 Power PCB relay T90								
Enclosure		N Open, no enclosure (snap-on dust cover available as an option) S Wash-tight, sealed plastic case with knock off nib for ventilation								
Contact arrangement		1 1 form A (1 NO)		2 1 form B (1 NC)		5 1 form C (1 CO)				
Coil Input		D DC voltage								
Mounting and termination		1 PCB terminals 4 PCB terminals, no common terminal between coil terminals (see PCB layout/terminal assignment drawing) Note: Terminal code 4 recommended for UL 873 applications. Consult factory for use of terminal code 1 for UL 873 applications.								
Contact material		2 AgCdO								
Coil voltage		Coil code: please refer to coil versions table								

Product Code	Enclosure	Contacts	Terminals	Contact Material	Coil	Part Number
T90N1D12-5	open, no cover	1 form A, 1 NO	PCB	AgCdO	5 VDC	7-1393208-4
T90N1D12-9					9 VDC	7-1393208-5
T90N1D12-12					12 VDC	6-1393208-5
T90N1D12-18					18 VDC	6-1393208-8
T90N1D12-24					24 VDC	7-1393208-0
T90N1D12-48					48 VDC	7-1393208-3
T90N1D12-110					110 VDC	6-1393208-4
T90N1D42-12			PCB, no extra COM		12 VDC	7-1393208-7
T90N1D42-24					24 VDC	7-1393208-9
T90N5D12-5		1 form C, 1 CO	PCB		5 VDC	9-1393208-5
T90N5D12-12					12 VDC	8-1393208-6
T90N5D12-18					18 VDC	9-1393208-0
T90N5D12-24					24 VDC	9-1393208-3
T90N5D12-48					48 VDC	9-1393208-4
T90N5D12-110					110 VDC	8-1393208-5
T90N5D42-12			PCB, no extra COM		12VDC	9-1393208-9
T90N5D42-24					24 VDC	1393209-2
T90S1D12-5	wash tight	1 form A, 1 NO	PCB		5 VDC	1-1393209-8
T90S1D12-6					6 VDC	1-1393209-9
T90S1D12-9					9 VDC	2-1393209-0
T90S1D12-12					12 VDC	1-1393209-2
T90S1D12-18					18 VDC	1-1393209-3
T90S1D12-24					24 VDC	1-1393209-6
T90S1D42-12			PCB, no extra COM		12 VDC	2-1393209-2
T90S1D42-24					24 VDC	2-1393209-5
T90S1D42-48					48 VDC	2-1393209-6
T90S5D12-5		1 form C, 1 CO	PCB		5 VDC	3-1393209-4
T90S5D12-12					12 VDC	2-1393209-8
T90S5D12-18					18 VDC	3-1393209-0
T90S5D12-24					24 VDC	3-1393209-1
T90S5D12-48					48 VDC	3-1393209-3
T90S5D42-12			PCB, no extra COM		12 VDC	1423094-1
T90S5D42-18					18 VDC	3-1393209-8
T90S5D42-24					24 VDC	4-1393209-0

X-ON Electronics

Largest Supplier of Electrical and Electronic Components

Click to view similar products for [General Purpose Relays](#) category:

Click to view products by [TE Connectivity](#) manufacturer:

Other Similar products are found below :

[PCN-105D3MH,000](#) [59641F200](#) [LY1SAC110120](#) [5X827E](#) [5X837F](#) [5X840F](#) [5X842F](#) [5X848E](#) [LY2N-AC120](#) [LY2S-AC220/240](#) [LY2-US-AC120](#) [LY3-US-AC120](#) [LY4F-UA-DC12](#) [LY4F-UA-DC24](#) [LY4F-US-AC120](#) [LY4F-US-AC240](#) [LY4F-US-DC24](#) [LY4F-VD-AC110](#) [LYQ20DC12](#) [M115C60](#) [M115N010](#) [M115N0150](#) [6031007G](#) [603-12D](#) [61211T0B4](#) [61212T400](#) [61222Q400](#) [61243B600](#) [61243C500](#) [61243Q400](#) [61311BOA2](#) [61311BOA6](#) [61311BOA8](#) [61311C0A2](#) [61311COA1](#) [61311COA6](#) [61311F0A2](#) [61311QOA1](#) [61311QOA4](#) [61311T0D6](#) [61311TOA6](#) [61311TOA7](#) [61311TOB3](#) [61311TOB4](#) [61311U0A6](#) [61312Q600](#) [61312T400](#) [61312T600](#) [61313U200](#) [61313U400](#)