

Type TLRS Series

Key Features

Three Sizes

Power ratings to 7W

Resistance value from 0.2mΩ~5mΩ

Electron beam welding, stable performance

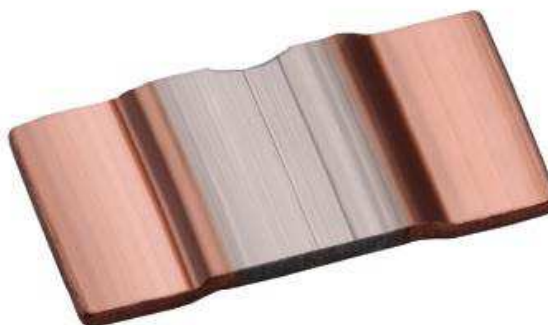

Applications

Current sensors for Hybrid power sources

Frequency converters

High Current Handling for Automotive Engine Controls and Power Management

TE Connectivity is pleased to offer this Low Ohmic Surface Mount Shunt Resistor. Featuring Heavy Copper connectors, electron beam welded to a Manganin or NiCr alloy element, this resistor offers excellent long term stability and low inductance, and can be mounted using re-flow soldering techniques or welding on copper.

Characteristics – Electrical

Type	Power Rating (W)	Resistance Range (mΩ)		TCR (PPM/°C)
		±1%	±5%	
TLRS0630	2.5	4		±100
	3	0.3, 0.5, 0.9, 1		±50
	3	2, 3		±100
TLRS1050	2	5		±100
	2.5	4		±100
	3	3		±100
	4	1		±60
	4	2		±100
	4	0.5		±75
TLRS1575	5	0.2, 0.3		±75
	3	5		±100
	3.5	3		±100
	4	2		±100
	6	0.5, 1		±100
	6	0.4		±50
	7	0.2		±50

Environmental Characteristics

Item	Requirement	Test Methods
Short time Overload	$\Delta R \leq \pm 0.5\%R$	Rated Power $\times 5$ for 5 seconds
Load Life	$\Delta R \leq \pm 1.0\%R$	70°C Rated Power for 1000 Hours
Resistance to Soldering Heat	$\Delta R \leq \pm 0.5\%R$	260°C for 10 \pm 1 seconds
Thermal Shock	$\Delta R \leq \pm 0.5\%R$	-55°C/175°C, 30min, 5 cycles
Moisture Resistance	$\Delta R \leq \pm 1.0\%R$	-55°C, 93 \pm 3%RH, 56 days
High Temperature Exposure	$\Delta R \leq \pm 1.0\%R$	175°C for 1000 hours
Vibration	$\Delta R \leq \pm 0.5\%R$	10~200Hz, 98m/S ² , 6 hours

Storage Temperature: 15 ~28 °C; Humidity < 80%RH

Construction and Dimensions:

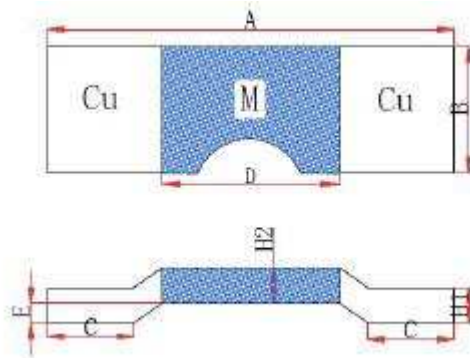

Type	Resistance (mΩ)	Material	A ±0.3 (mm)	B ±0.3 (mm)	C ±0.3 (mm)	D ±0.3 (mm)	E nom (mm)	H1 nom (mm)	H2 nom (mm)
TLRS0630	0.3	Manganin	6.35	3.05	1.14	3.0	0.35	0.95	0.95
	0.5	Manganin	6.35	3.05	1.14	3.0	0.35	0.89	0.89
	0.9	Manganin	6.35	3.05	1.14	3.0	0.35	0.50	0.50
	1	Manganin	6.35	3.05	1.14	3.0	0.35	0.42	0.42
	2	Manganin	6.35	3.05	1.14	3.0	0.35	0.72	0.62
	3	NiCr alloy	6.35	3.05	1.14	3.0	0.35	0.48	0.42
TLRS1050	0.2, 0.3	Manganin	10.5	5.0	2.0	5.0	0.50	1.42	1.42
	0.5	Manganin	10.5	5.0	2.0	5.0	0.50	0.76	0.88
	1	Manganin	10.5	5.0	2.0	5.0	0.50	0.38	0.43
	2	NiCr alloy	10.5	5.0	2.0	5.0	0.50	0.69	0.64
	3	NiCr alloy	10.5	5.0	2.0	5.0	0.50	0.43	0.43
	4	NiCr alloy	10.5	5.0	2.0	5.0	0.50	0.32	0.32
TLRS1575	0.2	Manganin	15.2	7.5	4.0	5.0	0.50	1.42	1.42
	0.4	Manganin	15.2	7.5	4.0	5.0	0.50	0.76	0.74
	0.5	Manganin	15.2	7.5	4.0	5.0	0.50	0.56	0.56
	1	Manganin	15.2	7.5	4.0	5.0	0.50	0.84	0.84
	2	NiCr alloy	15.2	7.5	4.0	5.0	0.50	0.40	0.40
	3	NiCr alloy	15.2	7.5	4.0	5.0	0.50	0.27	0.27
5	NiCr alloy	15.2	7.5	4.0	5.0	0.50	0.20	0.20	

Derating Curve

TLRS0630 / 1050

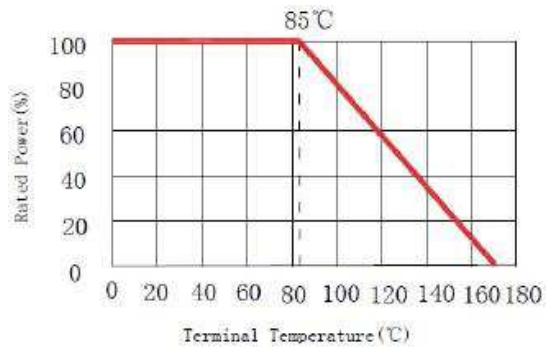

TLRS1575

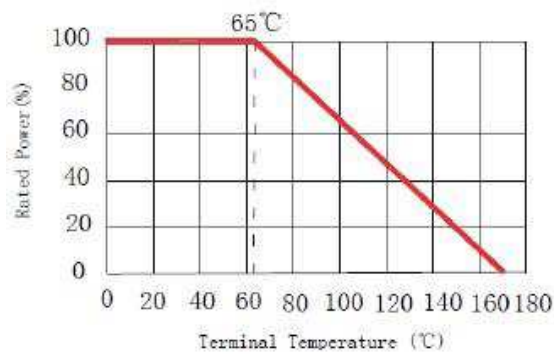

Pulse Energy

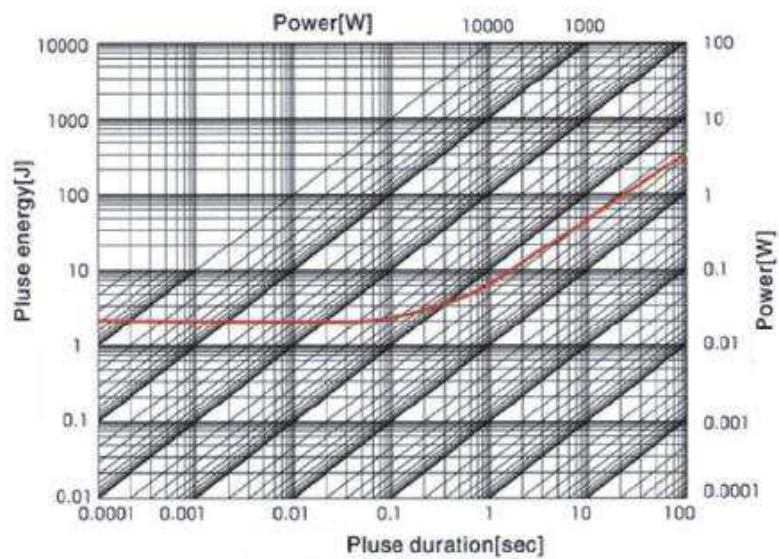

Packaging

Reel Dimensions (mm)

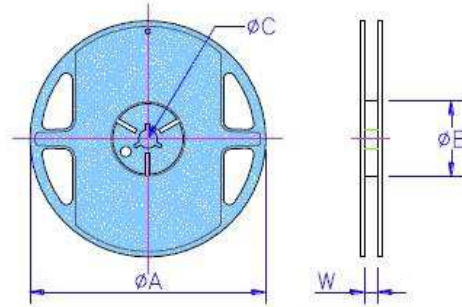

Type	Quantity	Tape Width (mm)	Reel Diameter (inch)	ØA ±1.0 (mm)	ØB ±0.5 (mm)	ØC +0.3/-0.2 (mm)	W ±0.5 (mm)
TLRS0630	5K	16	13	330.5	99.5	13.2	17.4
TLRS1050	3K	24	13	330.5	99.5	13.2	25.4
TLRS1575	2K	24	13	330.5	99.5	13.2	25.4

Tape Specifications – Embossed Plastic

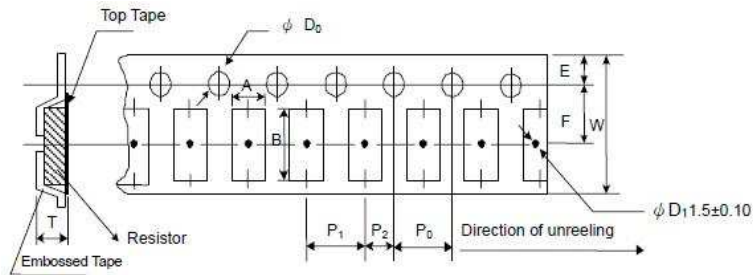

Type	A ±0.1 (mm)	B ±0.1 (mm)	W ±0.3 (mm)	E ±0.1 (mm)	F ±0.15 (mm)	P ₀ ±0.1 (mm)	P ₁ ±0.1 (mm)	P ₂ (mm)	ØD ₀ +0.1 -0 (mm)	T ±0.1 (mm)
0630	3.5	6.8	16.0	1.75	7.5	4.0	8.0	2.0	1.5	1.45
1050	5.7	11.2	24.0	1.75	11.5	4.0	8.0	2.0	1.5	2.05
1575	8.2	15.9	24.0	1.75	11.5	4.0	12.0	2.0	1.5	2.05

How To Order

TLRS1050	40	E	R002	F	TDG
Common Part	Power Rating	TCR	Resistance Code	Tolerance Code	Packaging
TLRS0630 TLRS1050 TLRS1575	25 – 2.5W 30 – 3W 35 – 3.5W 40 – 4W 50 – 5W Etc.	D - ±50PPM P - ±60PPM W - ±75PPM E - ±100PPM	R0002 – 0.2mΩ R001 – 1mΩ	F - ±1% J - ±5%	TDG – Standard Tape and Reel Quantity as above chart

X-ON Electronics

Largest Supplier of Electrical and Electronic Components

Click to view similar products for [Gate Drivers](#) category:

Click to view products by [TE Connectivity](#) manufacturer:

Other Similar products are found below :

[00053P0231](#) [8967380000](#) [56956](#) [CR7E-30DB-3.96E\(72\)](#) [57.404.7355.5](#) [LT4936](#) [57.904.0755.0](#) [5803-0901](#) [58410](#) [5882900001](#) [00600P0005](#)
[00-9050-LRPP](#) [00-9090-RDPP](#) [5951900000](#) [01-1003W-10/32-15](#) [LTLA6E-1S-WH-RC-FN12VXCR1](#) [0131700000](#) [00-2240](#) [LTP70N06](#)
[LVP640](#) [0158-624-00](#) [5J0-1000LG-SIL](#) [020017-13](#) [LY1D-2-5S-AC120](#) [LY2-0-US-AC120](#) [LY2-US-AC240](#) [LY3-UA-DC24](#) [00-5150](#)
[00576P0020](#) [00600P0010](#) [LZNQ2M-US-DC5](#) [LZNQ2-US-DC12](#) [LZP40N10](#) [00-8196-RDPP](#) [00-8274-RDPP](#) [00-8275-RDNP](#) [00-8609-](#)
[RDPP](#) [00-8722-RDPP](#) [00-8728-WHPP](#) [00-8869-RDPP](#) [00-9051-RDPP](#) [00-9091-LRPP](#) [00-9291-RDPP](#) [0207100000](#) [0207400000](#) [60100564](#)
[01312](#) [0134220000](#) [6035](#) [M15730061](#)