

THIS DRAWING IS UNPUBLISHED. RELEASED FOR PUBLICATION
 © COPYRIGHT - By - ALL RIGHTS RESERVED.

LOC		DIST		REVISIONS			
P	LTR	DESCRIPTION		DATE	DWN	APVD	
B1		REVISED PER ECO-11-004820		11MAR11	RK	HMR	

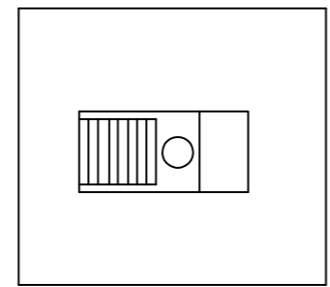
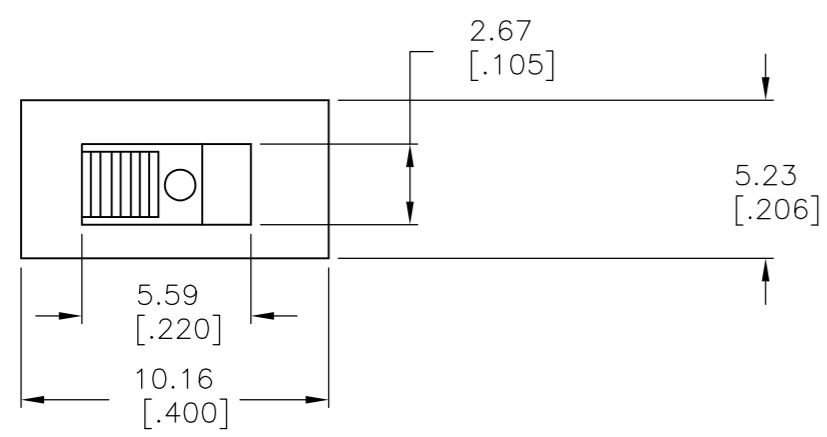

MATERIALS:
 CASE: LCP, 94V-0.
 ACTUATOR: PBT, 94V-0.
 MOVING CONTACT: COPPER, GOLD PLATE OVER NICKEL.
 FIXED CONTACT/TERMINAL: COPPER, GOLD PLATE OVER NICKEL.

ELECTRICAL:
 CONTACT RATING: 0.4 VA MAX. @ 20 VDC OR PEAK AC.
 INITIAL CONTACT RESISTANCE: 20 MILLIOHMS MAX. 100 MV & 1 MA. MIN. AT 500 VDC.
 INSULATION RESISTANCE: 1,000 M
 DIELECTRIC STRENGTH: 1000 VOLTS RMS AT SEA LEVEL.
 LIFE: 60,000 - 80,000 CYCLES.

MECHANICAL:
 ACTUATION FORCE: 150-600 GRAMS

ENVIRONMENTAL:
 OPERATING TEMPERATURE: -4°F TO + 176°F (-20°C TO +80°C)
 STORAGE TEMPERATURE: -4°F TO + 176°F (-20°C TO +80°C)
 SOLDER HEAT RESISTANCE PER EIA-364-56A, PROCEDURE 3, COND. B
 SOLDERABILITY PER EID 364-52, CLASS 2 CATEGORY 1

- 1 CENTER TERMINAL NOT FURNISHED.
- 2 ALL MATERIALS AND FINISHES SHALL COMPLY WITH EU DIRECTIVE 2002/95/EC OF 27JAN2003 (ROHS).

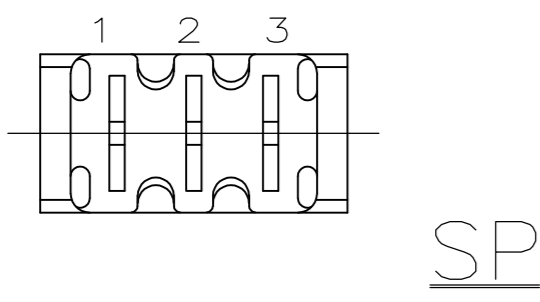
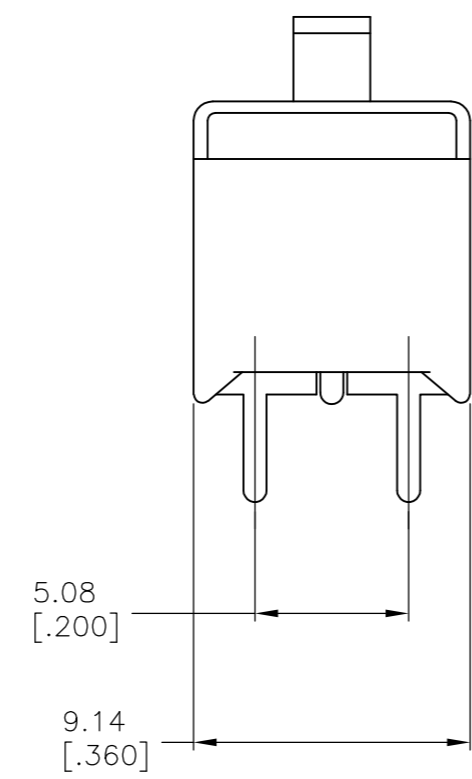
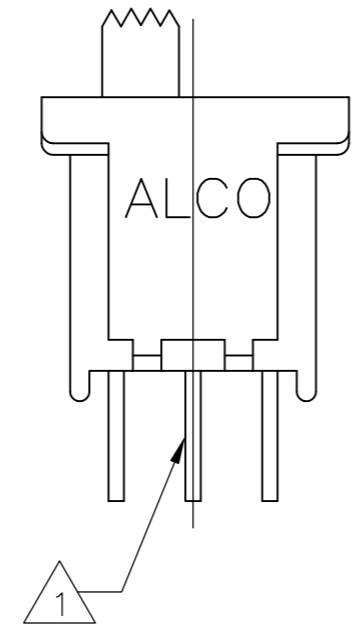
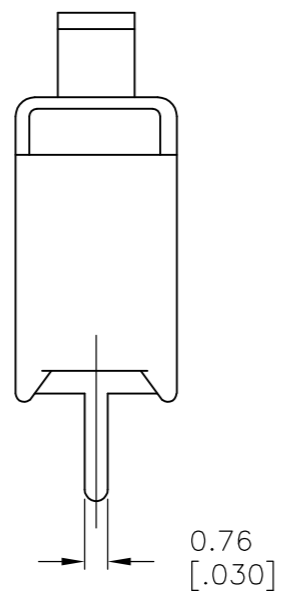
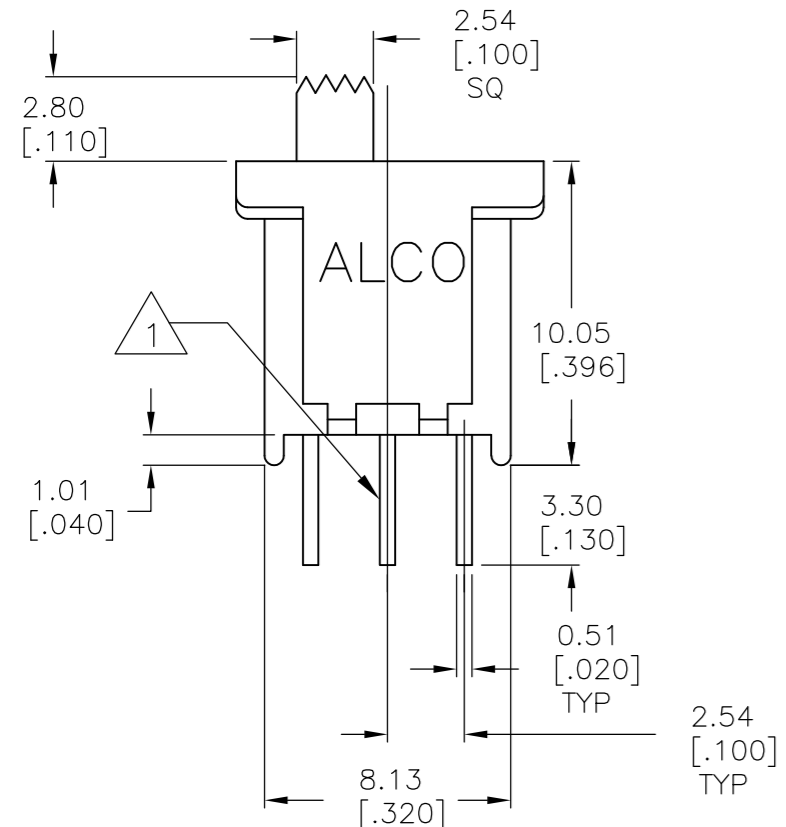

SP

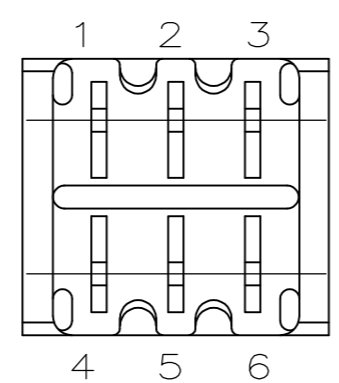

DP

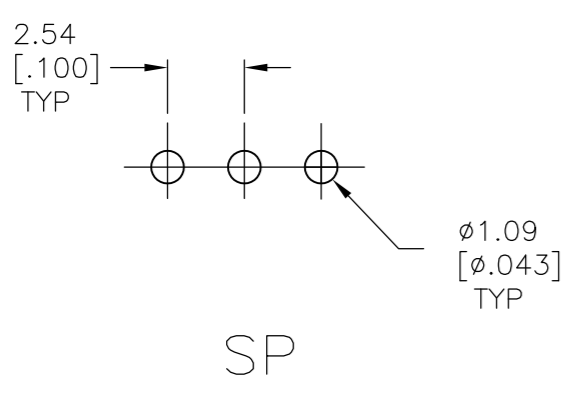

SP

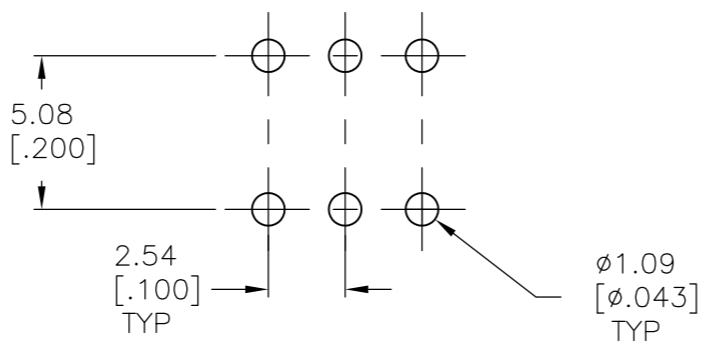

DP

RECOMMENDED HOLE LAYOUT
 LAYOUT TOLERANCES ±0.05[.002]

P/N	Alco P/N	Actuator Flush/Extended	Position	Type			
1571982-1	TSS11DGPC04	Extended	2	SPDT	1,2 4 5 6	None	2,3
1571982-2	TSS11DG1PC04	Flush	2	SPDT	1,2	None	2,3
1571982-3	TSS11EG1PC04	Flush	3	SPDT	1,2	Off	2,3
1571982-4	TSS11EGPC04	Extended	3	SPDT	1,2	Off	2,3
1571982-5	TSS21KGPC04	Extended	2	DPDT	1-3, 4-6	None	Off
1571982-6	TSS21NG1PC04	Flush	2	DPDT	1-2, 4-5	None	2-3, 5-6
1571982-7	TSS21NGPC04	Extended	2	DPDT	1-2, 4-5	None	2-3, 5-6
1571982-8	TSS21PG1PC04	Flush	3	DPDT	1-2, 4-5	Off	2-3, 5-6
1571982-9	TSS21PGPC04	Extended	3	DPDT	1-2, 4-5	Off	2-3, 5-6

1

THIS DRAWING IS A CONTROLLED DOCUMENT. 28FEB2006

DWN M.BINNER	TE Connectivity SLIDE SWITCH TSS11 AND TSS21 SERIES			
CHK M.SARVER				
APVD M.SARVER				
PRODUCT SPEC				
APPLICATION SPEC	NAME			
WEIGHT	SIZE	CAGE CODE	DRAWING NO	RESTRICTED TO
CUSTOMER DRAWING	A2	00779	C=1571982	-
	SCALE	SHEET	REV	
	1:1	1 OF 1	B1	

X-ON Electronics

Largest Supplier of Electrical and Electronic Components

Click to view similar products for [Slide Switches](#) category:

Click to view products by [TE Connectivity](#) manufacturer:

Other Similar products are found below :

[6-1437581-1](#) [M43R](#) [MHS123K15D](#) [MHS133K](#) [MHSS1104A](#) [MMD](#) [GH49S010001](#) [MSS12A](#) [EPS1PC1](#) [1825074-1](#) [1825160-3](#) [1825167-2](#)
[1825289-7](#) [25139NLDB](#) [25449NAH](#) [SLB1240R45](#) [1825078-1](#) [1825080-4](#) [1825269-1](#) [1825270-2](#) [STS141RA04](#) [T2215BEN506](#)
[GH46P000001](#) [GH46W000001](#) [GH49P010001](#) [25339NA](#) [M42A](#) [TG36P000000](#) [TG36P000050](#) [AYZ0202AG](#) [47227LFE](#) [49331L](#) [50208L](#)
[L203091MS02Q](#) [4-1437581-7](#) [X2225CR-437W](#) [49329L](#) [1101M1S3ZB8E2](#) [1-1437581-1](#) [MSS2225G04](#) [TG39W000000](#) [1825075-1](#)
[MSS42G](#) [TG36WS80065](#) [T105S1CWZBE](#) [SLB124145](#) [SLB1280R5](#) [SLB1340R45](#) [25136NLDB](#) [TG39W000050](#)