

Power Relay K (Open – Sealed)

- Limiting continuous current 45A
- Wide voltage range
- 24VDC coil versions available
- For high current version refer to Power Relay K-S

Typical applications

ABS control, blower fans, car alarm, cooling fan, engine control, fuel pump, hazard warning signal, heated front screen, heated rear screen, ignition, lamps front/rear/fog light, interior lights, main switch/supply relay, seat control, seatbelt pretensioner, sun roof, turn signal, valves, window lifter, wiper control.

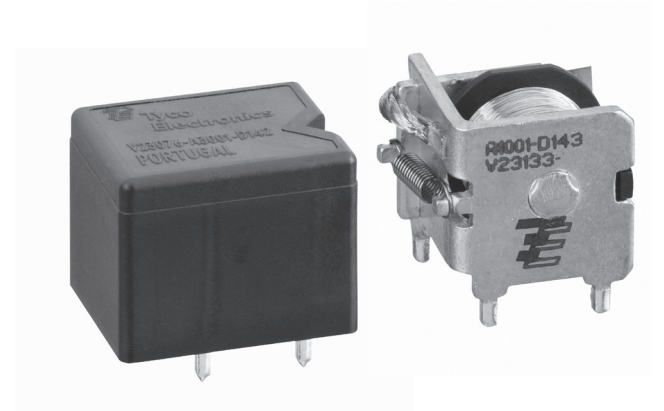

Contact Data

Typical applications	Resistive/inductive loads	Resistive/inductive loads	Indicator lamps	Headlights, capacitive loads	Headlights capacitive loads
Contact arrangement	1 form A, 1 NO	1 form C, 1 CO	1 form A, 1 NO	1 form A, 1 NO	1 form C, 1 CO
Rated voltage	12VDC	12VDC	12VDC	12VDC	12VDC
Rated current	45A	A/B (NO/NC)	30A	40A	A/B (NO/NC)
Limiting continuous current		45/30A			40/25A
23°C	45A	45/30A	30A	40A	40/25A
85°C	30A	30/25A	25A	25A	25/20A
Limiting making current ¹⁾	100A	100/30A	120A ³⁾	180A	180/60A
Limiting breaking current ²⁾	60A	60/30A	60A	60A	60/30A
Contact material	AgNi0.15	AgNi0.15	AgSnO ₂	AgSnO ₂	AgSnO ₂
Min. recommended contact load		1A at 5VDC ⁴⁾			
Initial voltage drop, at 10A, typ./max.		20/300mV			
Operate/release time		typ. 5/3ms ⁵⁾			
Electrical endurance	>2x10 ⁵ ops. at 13.5VDC, 40A	>2x10 ⁵ ops. at 13.5VDC, 40A	>2.2x10 ⁶ ops. up to 8x21W	>10 ⁵ ops. up to 4x60W	>10 ⁵ ops. up to 4x60W
Mechanical endurance, DC coil		>10 ⁷ ops.			

- 1) The values apply to a resistive or inductive load with suitable spark suppression and at maximum 13.5VDC for 12VDC or 27VDC for 24VDC load voltages.
- 2) For a load current duration of maximum 3s for a make/break ratio of 1:10.
- 3) Corresponds to a peak inrush current on initial actuation (cold filament).
- 4) See chapter Diagnostics of Relays in our Application Notes or consult the internet at <http://relays.te.com/appnotes/>
- 5) For unsuppressed relay coil. A low resistive suppression device in parallel to the relay coil increases the release time and reduces the lifetime caused by increased erosion and/or higher risk of contact tack welding.

Max. DC load breaking capacity

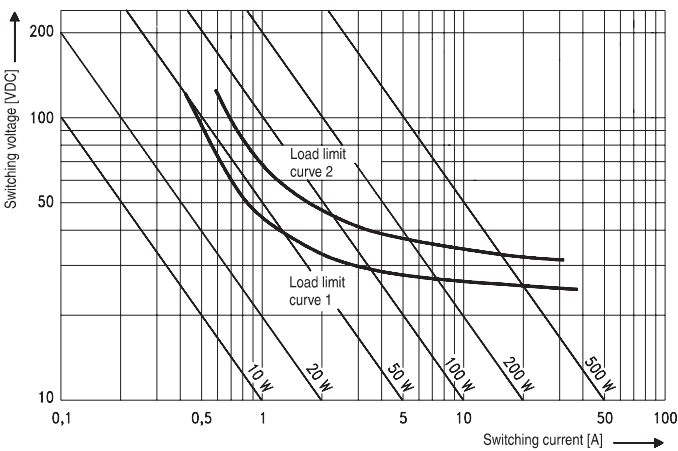

Load limit curve 1: arc extinguishes, during transit time (changeover contact).
 Load limit curve 2: safe shutdown, no stationary arc (make contact).
 Load limit curves measured with low inductive resistors verified for 1000 switching events.

Power Relay K (Open – Sealed) (Continued)

Coil Data

Rated coil voltage	12VDC / 24VDC
--------------------	---------------

Coil versions, DC coil

Coil code	Rated voltage VDC	Operate voltage VDC	Release voltage VDC	Coil resistance $\Omega \pm 10\%$	Rated coil power W
001	12	6.9	1.2	90	1.6
022	24	14.1	2.4	362	1.6

All figures are given for coil without pre-energization, at ambient temperature +23°C. Other coils on request.

Coil operating range

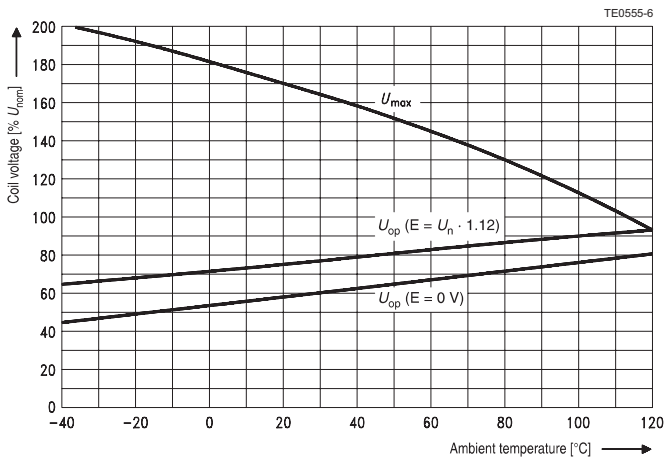

Does not take into account the temperature rise due to the contact current
E = pre-energization

Insulation Data

Initial dielectric strength	
between open contacts	500VAC _{rms}
between contact and coil	500VAC _{rms}

Other Data

EU RoHS/ELV compliance	compliant
Ambient temperature, DC coil	-40 to +85°C ⁶⁾
Climatic cycling with condensation, EN ISO 6988	3 cycles, storage 8/16h
Temperature cycling (shock), IEC 60068-2-14, Na	20 cycles, -40/+85°C (dwell time 1h)
Damp heat cyclic, IEC 60068-2-30, Db, Variant 1	6 cycles, upper air temperature 55°C
Damp heat constant, IEC 60068-2-3, method Ca	56 days, upper air temperature 55°C
Degree of protection, IEC 61810	RT 0/II – open version RT III – immersion cleanable version
Corrosive gas, IEC 60068-2-42	10 days
IEC 60068-2-43	10 days
Vibration resistance (functional), IEC 60068-2-6 (sine pulse form), acceleration, acc. to position	10 to 200Hz, 20 to 40g ⁷⁾
Shock resistance (functional), IEC 60068-2-27 (half sine form single pulses), acceleration, acc. to position	8ms 30g ⁷⁾
Terminal type	PCB
Weight	
sealed version	approx. 22g (0.77oz)
open version	approx. 19g (0.67oz)
Solderability (aging 3: 4h/155°C) for leaded process (T _m = 183°C), for Pb-free process (T _m = 217°C), IEC 60068-2-20	T _a , method 1, hot dip 5s, 215°C according IEC 600688 ⁸⁾
Storage conditions	
Packaging unit	
sealed version	525 pcs.
open version	500 pcs.

6) See coil operating range DC.
7) No change in the switching state >10μs.
8) For general storage and processing recommendations please refer to our Application Notes and especially to Storage in the Definitions or at <http://relays.te.com/appnotes/>

Terminal Assignment (Open and Sealed Version)

Bottom view on solder pins

1 form A, 1 NO

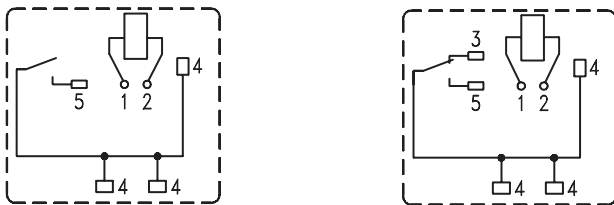

*) Terminal 4 to be bridged

Power Relay K (Open – Sealed) (Continued)

Dimensions

Power Relay K open version

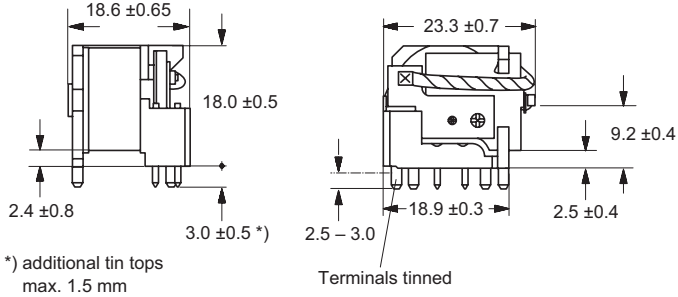

Power Relay K sealed version

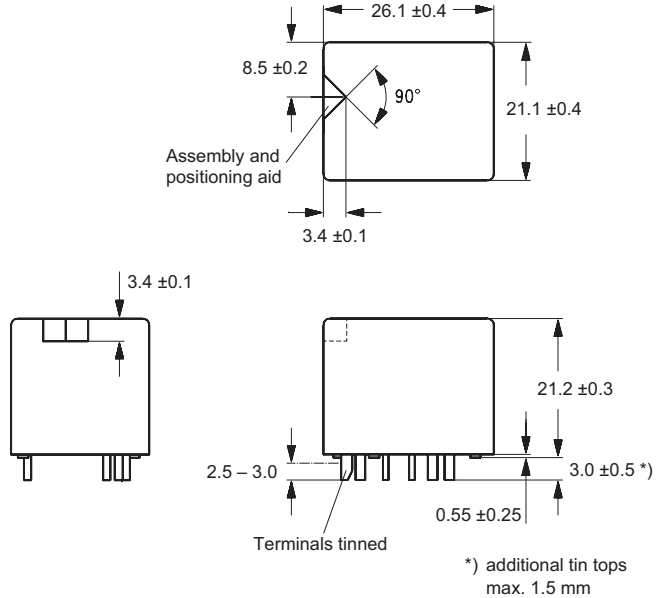

Mounting Hole Layout

Bottom view on solder pins

Power Relay K open version

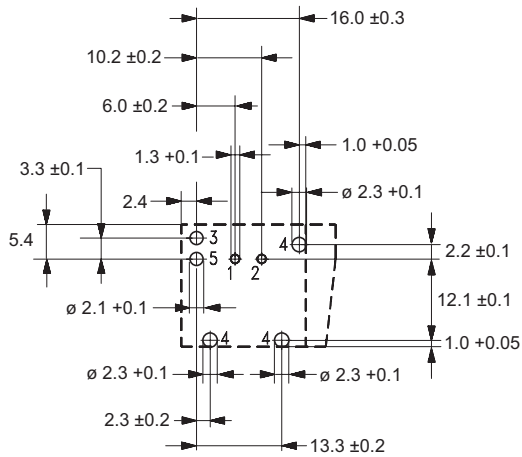

Power Relay K sealed version

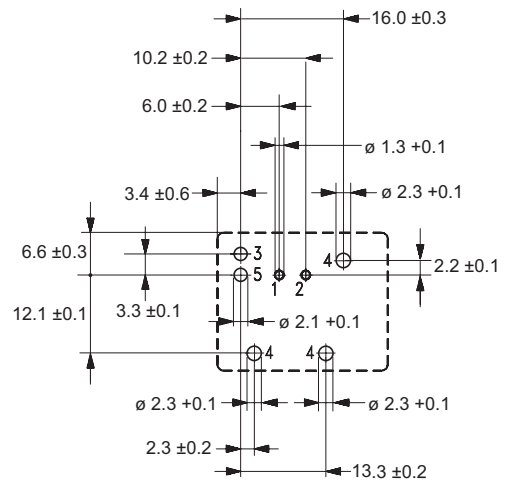

Power Relay K (Open – Sealed) (Continued)

Product code structure		Typical product code		V23076	-A	1	022	-C	13	3
Type										
		V23076 Power Relay K, sealed								
		V23133 Power Relay K, open								
Terminal		A PCB								
Design		1 Single relay		3 Single relay						
Coil		001 12VDC		022 24VDC						
Contact type		C Single contact		D Single contact						
Contact material		13 AgNi0.15		14 AgSnO ₂						
		15 AgSnO ₂ (Special)								
Contact arrangement		2 1 form A, 1 NO		3 1 form C, 1 CO						

Product code	Terminal/Encl.	Design	Coil	Contact	Cont. material	Arrangement	Part number				
V23076-A1001-C133	PCB, sealed	Single relay	12VDC	Single	AgNi0.15	1 form C, CO	1393277-4				
V23076-A1001-D143					AgSnO ₂		1393277-6				
V23076-A3001-C132	PCB, open	Single relay	24VDC	Single	AgNi0.15	1 form A, NO	1-1393277-4				
V23076-A3001-D142					AgSnO ₂		1-1393277-7				
V23076-A3001-D152 ¹⁾					AgSnO ₂ special	1-1414175-0					
V23076-A1022-C133					AgNi0.15	1 form C, CO	1393277-8				
V23076-A1022-D143					AgSnO ₂		1393277-9				
V23076-A3022-C132					AgNi0.15	1 form A, NO	1-1393277-8				
V23076-A3022-D142					AgSnO ₂		1-1393277-9				
V23133-A1001-C133					PCB, open	Single relay	12VDC	Single	AgNi0.15	1 form C, CO	1393278-7
V23133-A1001-D143									AgSnO ₂		1-1393278-3
V23133-A3001-C132									AgNi0.15	1 form A, NO	5-1393278-7
V23133-A3001-D142	AgSnO ₂	5-1393278-9									
V23133-A3001-D152 ¹⁾	AgSnO ₂ special	1-1414173-0									
V23133-A1022-C133	AgNi0.15	1 form C, CO	3-1393278-7								
V23133-A1022-D143	AgSnO ₂		3-1393278-9								
V23133-A3022-C132	AgNi0.15	1 form A, NO	7-1393278-1								
V23133-A3022-D142	AgSnO ₂		7-1393278-2								
V23133-A3022-D152 ¹⁾	AgSnO ₂ special	1-1414174-0									

1) For indicator lamps.

X-ON Electronics

Largest Supplier of Electrical and Electronic Components

Click to view similar products for [General Purpose Relays](#) category:

Click to view products by [TE Connectivity](#) manufacturer:

Other Similar products are found below :

[PCN-105D3MH,000](#) [59641F200](#) [5JO-1000CD-SIL](#) [5X827E](#) [5X837F](#) [5X840F](#) [5X842F](#) [5X848E](#) [LY2N-AC120](#) [LY2-US-AC120](#) [LY2-US-DC24](#) [LY3-US-AC120](#) [LY4F-UA-DC12](#) [LY4F-UA-DC24](#) [LY4F-US-AC120](#) [LY4F-US-AC240](#) [LY4F-US-DC24](#) [LY4F-VD-AC110](#)
[M115C60](#) [M115N010](#) [M115N0150](#) [603-12D](#) [60HE1-5DC](#) [60HE2S-12DC](#) [61211T0B4](#) [61212T400](#) [61222Q400](#) [61243B600](#) [61243C500](#)
[61243Q400](#) [61311BOA2](#) [61311BOA6](#) [61311BOA8](#) [61311C0A2](#) [61311COA1](#) [61311COA6](#) [61311F0A2](#) [61311QOA1](#) [61311QOA4](#)
[61311T0D6](#) [61311TOA6](#) [61311TOA7](#) [61311TOB3](#) [61311TOB4](#) [61311U0A6](#) [61312Q600](#) [61312T400](#) [61312T600](#) [61313U200](#) [61313U400](#)