

REV
NC **WB-48P***

| REVISIONS | | | |
|-----------|-----------------------------|--------|----------|
| SYM | DESCRIPTION | DATE | APPROVED |
| NC | NEW RELEASE PER E.O. P17165 | 3-7-01 | RDR |
| | | | |
| | | | |

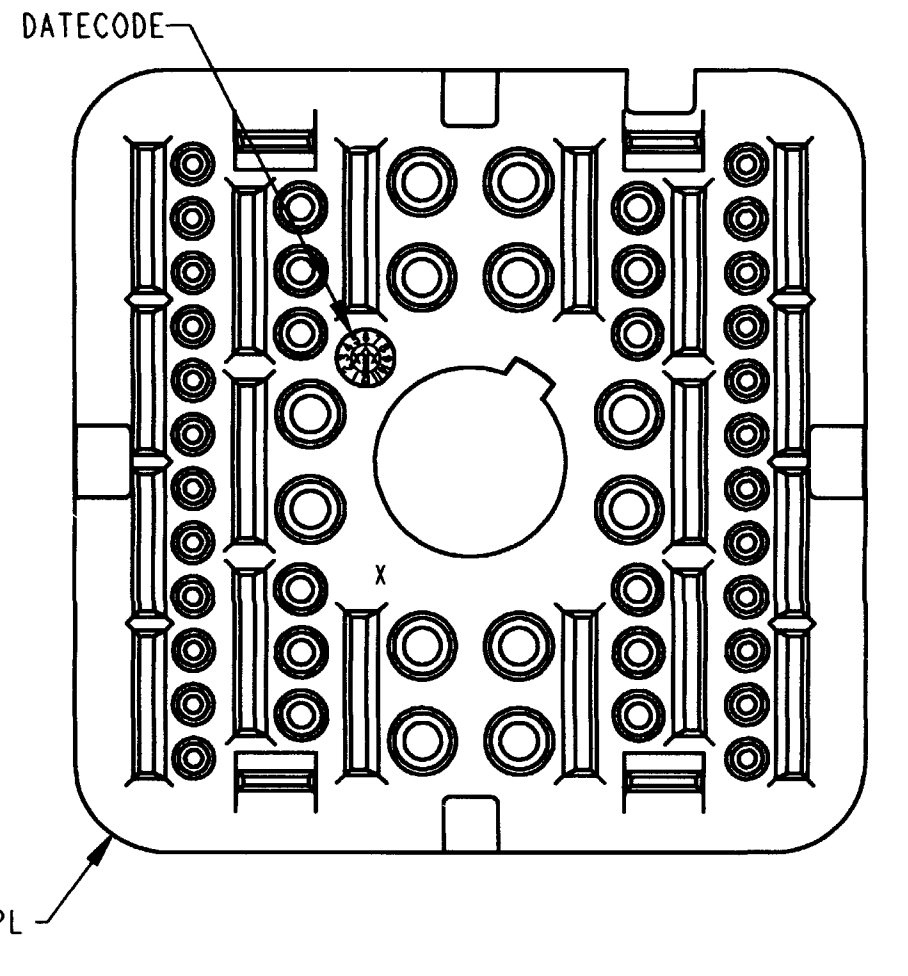

- NOTES:
1. DIMENSIONS ARE IN INCHES [mm].
 2. DIMENSION TOLERANCE: $\pm .025$ [.64].
 3. THIS WEDGE LOCK MATES WITH DRB12-48P*(N)E-**** RECEPTACLE. (* = A,B,C,D KEYS; **** = ALL MODIFICATIONS). CONSULT FACTORY FOR MODS.
 4. MATERIAL: PLASTIC
 5. SEE SHEET 2 FOR OTHER KEY ARRANGEMENTS.

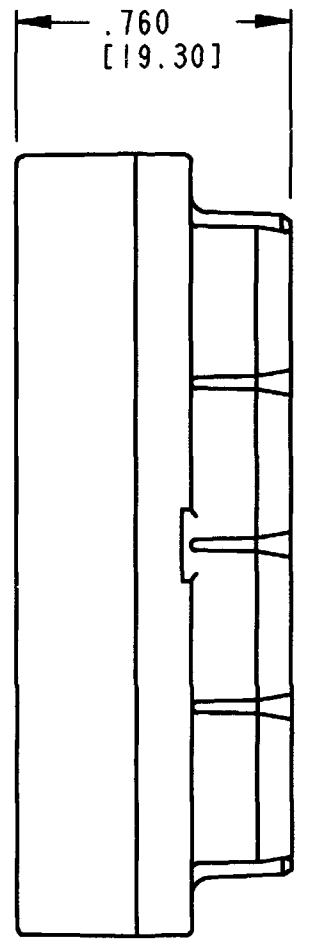
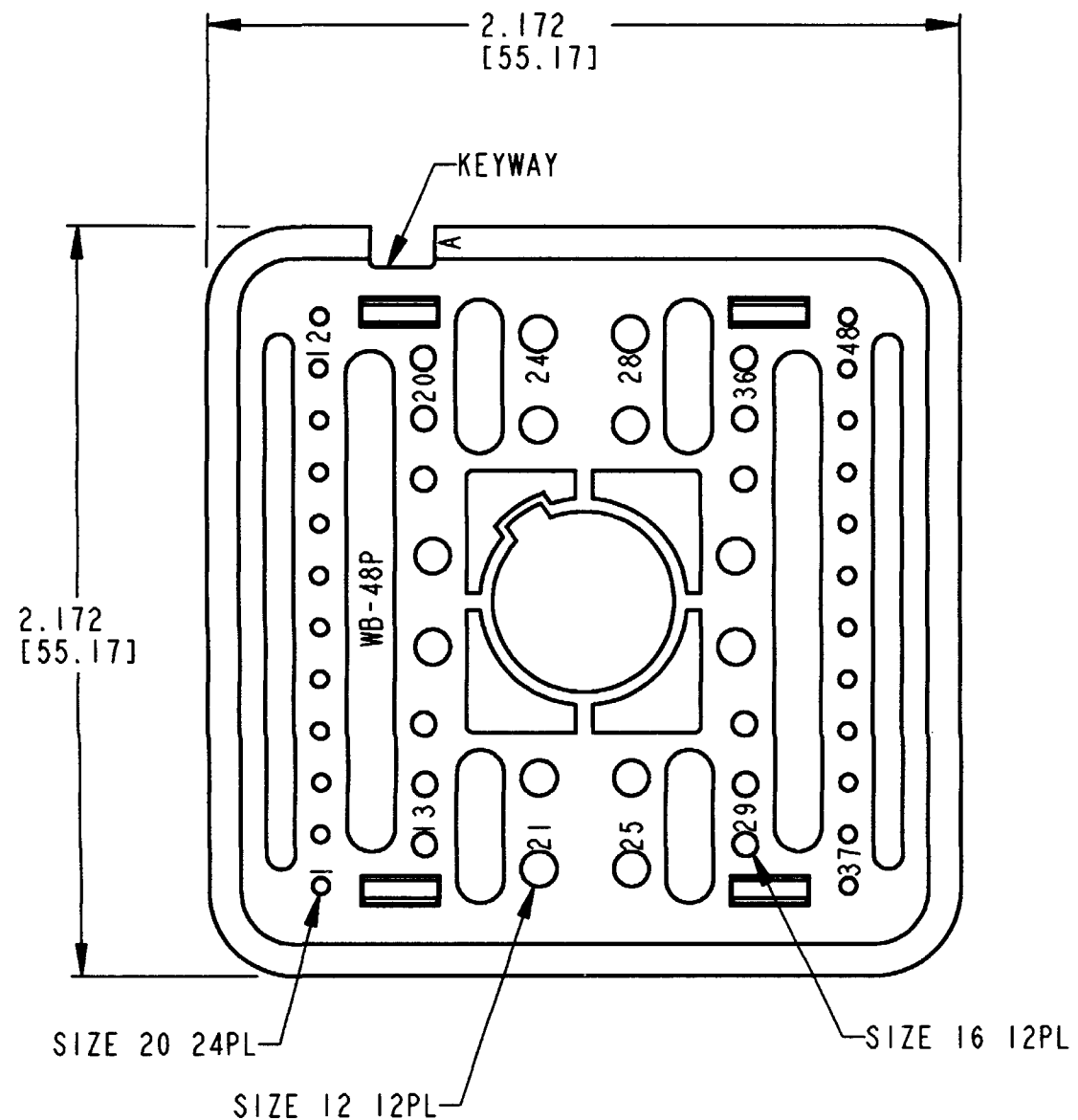
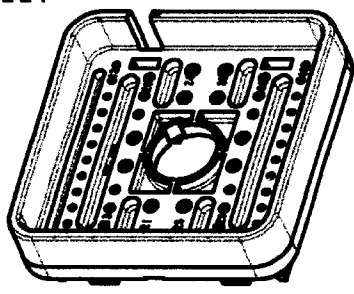

| SIGNATURE & DATE | |
|------------------|---------------------------|
| DR | S. PALLUTH 02/28/01 |
| CHK | <i>[Signature]</i> 3/6/01 |
| PE | <i>[Signature]</i> 3/1/01 |
| APPD | <i>[Signature]</i> 3/1/01 |
| SCALE | NONE |

WEDGE LOCK, RECEPTACLE
48 CONTACTS
KEY ARRANGEMENTS
A, B, C, & D
DRB SERIES
ENVELOPE

| | | |
|---|----------------|--------------|
| CP | EP063 | MATL. CODE |
| The Deutsch Company DEUTSCH I.P.D. 3850 INDUSTRIAL AVE. HEMET, CALIF. 92545 | | |
| B | WB-48P* | |
| DWG SIZE | CODE 11139 | SHEET 1 OF 2 |

| | | | | | |
|-----|---------|-----------|-------------|--------|----------|
| REV | WB-48P* | REVISIONS | | | |
| NC | | SYM | DESCRIPTION | DATE | APPROVED |
| | | | SEE SHEET 1 | 3-7-01 | RDR |
| | | | | | |
| | | | | | |

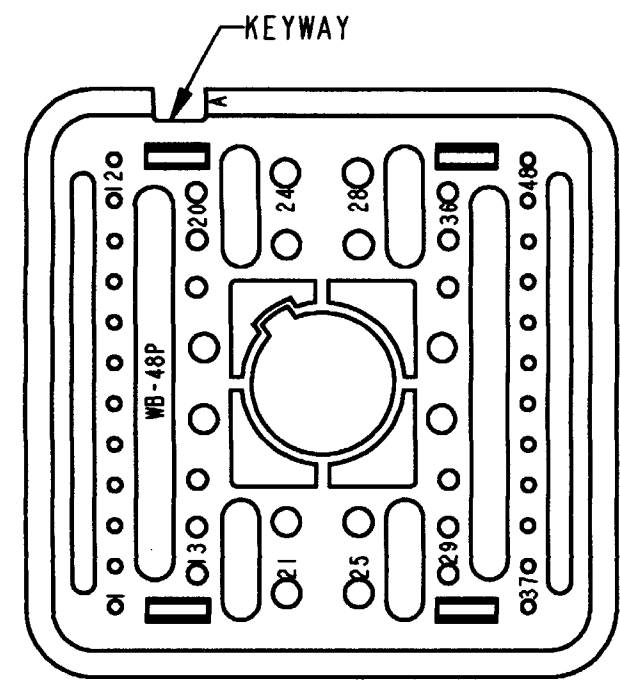

WB-48PA
KEY ARRANGEMENT -A-
COLOR: GREY

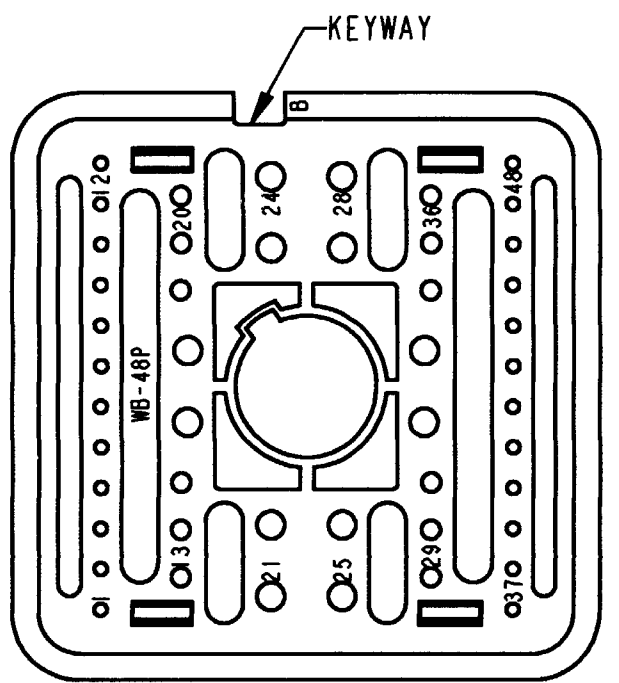

WB-48PB
KEY ARRANGEMENT -B-
COLOR: BLACK

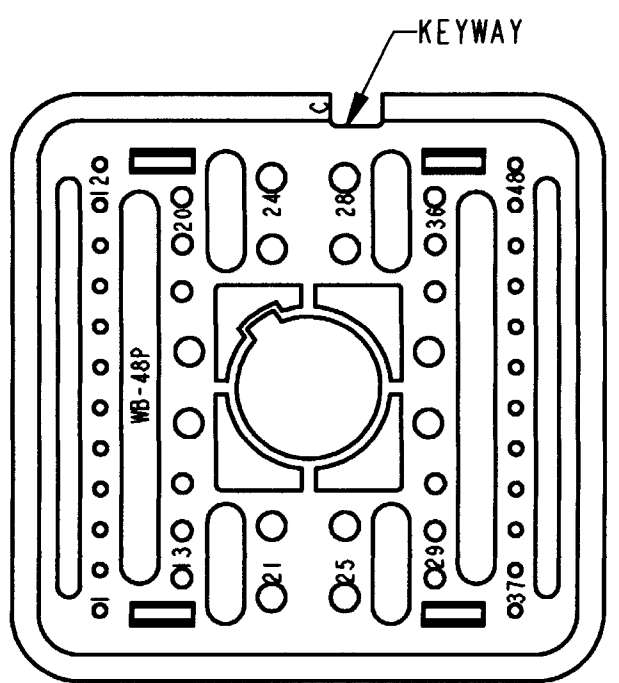

WB-48PC
KEY ARRANGEMENT -C-
COLOR: GREEN

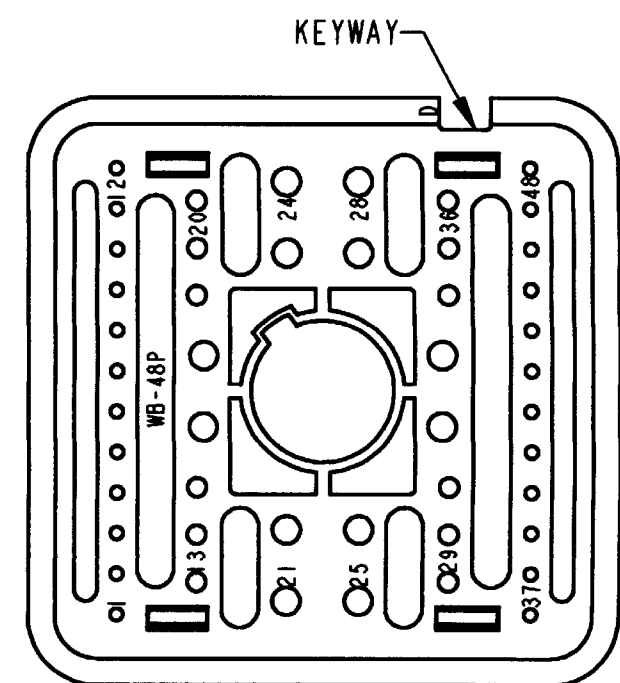

WB-48PD
KEY ARRANGEMENT -D-
COLOR: BROWN

NOTES:

| | | | | | |
|------------------|---------------------|---|--|----------|------------|
| SIGNATURE & DATE | | WEDGE LOCK, RECEPTACLE 48 CONTACTS KEY ARRANGEMENTS A, B, C, & D DRB SERIES ENVELOPE | CP | EP063 | MATL. CODE |
| DR | S. PALLUTH 02/28/01 | | The Deutsch Company DEUTSCH I.P.D. 3850 INDUSTRIAL AVE. HEMET, CALIF. 92545 | | |
| CHK | A. Blum 3/6/01 | | B | WB-48P* | |
| PE | S. Palluth 3/1/01 | | | DWG SIZE | CODE 11139 |
| APPD | [Signature] 3/1/01 | | | | |
| SCALE | NONE | | | | |

X-ON Electronics

Largest Supplier of Electrical and Electronic Components

Click to view similar products for [Automotive Connectors](#) category:

Click to view products by [TE Connectivity](#) manufacturer:

Other Similar products are found below :

[003-018-000](#) [60403001](#) [60993906-B](#) [M902-2131](#) [M902-2161](#) [72.330.1035.1](#) [73.353.4028.0](#) [F119300-B](#) [F166900](#) [F258300-B](#) [F358300-B](#)
[F407400](#) [F444110](#) [F487000](#) [F509500B-B](#) [827153-1](#) [8N1515-32-24P](#) [9-1326729-8](#) [925474-1](#) [928905-1](#) [964562-4](#) [968782-1](#) [GT17SA-8DS-](#)
[HU](#) [98891-1012](#) [98947-1016](#) [12004147](#) [12004475-L](#) [12010290](#) [12010309-B](#) [12015454](#) [12020219-B](#) [12020308](#) [12041318-B](#) [12052225-L](#)
[12052466](#) [12059125](#) [12064869](#) [12004327-B](#) [12010503-B](#) [12015308](#) [12015384](#) [12015909](#) [1-21030-1](#) [12041254](#) [12041318](#) [12047946-B](#)
[12047957](#) [12047957-L](#) [12059473](#) [12066261](#)