

**Table of Contents**

KILOVAC WD Series, DIN Rail or Screw Mounted Protective Relays

- Introduction . . . . . 11-2
- KILOVAC WD25 Paralleling Relays. . . . . 11-3
- KILOVAC WD2759 Over/Undervoltage Relays . . . . . 11-4, 11-5
- KILOVAC WD32 Reverse Power Relays. . . . . 11-6, 11-7
- KILOVAC WD47 Phase Sequence Relays . . . . . 11-8
- KILOVAC WD5051 1Ø and 3Ø Overcurrent Relays . . . . . 11-9, 11-10
- KILOVAC WD810U Over/Underfrequency Relays . . . . . 11-11

Voltage Sensitive Relays

- WUV/WOV DC Series . . . . . 11-12
- WUV/WOV Series . . . . . 11-13
- WUVT/WOVT Series . . . . . 11-14
- WOUV DC Series, Over/Undervoltage . . . . . 11-15
- WOUVT Series, Over/Undervoltage . . . . . 11-16
- 250 Series, Over/Undervoltage . . . . . 11-17
- D100X Series, Close Differential . . . . . 11-18
- D101X Series, 3 Phase Adjustable, Close Differential . . . . . 11-19

Reverse Power Relay

- 700 Series w/ Adjustable Time Delay . . . . . 11-20

Phase Failure Relay

- 1000 Series . . . . . 11-21

Phase Sequence Relay

- 900 Series . . . . . 11-22

Current Balance Relay

- WCB Series . . . . . 11-23

Current Sensitive Relays

- WC1 & WCT1 Series, Overcurrent . . . . . 11-24
- WC3 & WCT3 Series, Overcurrent . . . . . 11-25

Current Differential Relay

- WCD Series . . . . . 11-26

Paralleling Relays

- 1800 Series . . . . . 11-27
- Selection Guide . . . . . 11-27

Frequency Sensitive Relays

- WOF & WUF Series. . . . . 11-28
- WOUF Series, Over/Underfrequency . . . . . 11-29
- 20-000 Series. . . . . 11-30
- 25-000 Series. . . . . 11-31
- 20-050-19 Series (Voltage/Frequency) . . . . . 11-32

Ground Fault Relays

- WGD Series — Floating Ground . . . . . 11-33
- WC1G Series — Grounded . . . . . 11-34

Additional Relays. . . . . 11-35 – 11-43

## KILOVAC WD Series, DIN Rail or Screw Mounted Protective Relays

### Product Facts

- **WD25 Paralleling (Synch Check) Relays**
- **WD2759 Over/undervoltage Relays**
- **WD32 Reverse Power Relays**
- **WD47 Phase Sequence Relays**
- **WD5051 Single- or Three-Phase Overcurrent Relays**
- **WD810U Over/Underfrequency Relays**
- **File E58048, DIN EN50022-35**

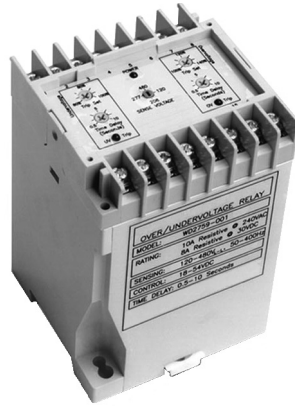

The WD series offers several different models of protective relays in a common package that is suitable for either DIN rail or screw mounting. These flexible, multifunction devices offer user selectable voltages, sense currents and frequencies. Adjustable time delays are standard. This allows a single part number to be suitable for multiple applications, thereby reducing inventory costs.

### Specifications Common to All Models

**Power Consumption** — 2.5VA, maximum.

**Contact Ratings** —  
5 amps, resistive, at 120VAC.  
5 amps, resistive, at 30VDC.

**Isolation from Control to Sense Inputs** — 2,500VAC.

**Mechanical Life** — 10 million operations.

**Shock** — 10g.

**Vibration** — 0.062 (1.57) double amplitude at 10-55 Hz.

**Terminals** — M3.5 screws.

**Maximum Wire Size** — 2 x 24 AWG (2.5mm<sup>2</sup>) solid to DIN 46288 or 2 x 16 AWG (1.5mm<sup>2</sup>) stranded w/end sleeves.

**Operating Temperature Range** — -40°C to +60°C.

**Enclosure** — Plastic case (not sealed).

**Mounting Options** — Snap mounts on standard DIN rail (DIN-EN 50022-35) or panel mounts with M4, M5, #8 or #10 screws.

**Weight** — 14.4 oz. (400g) approximately.

### Installation and Maintenance Information

**Installation** — To mount the WD series protective relay on a DIN rail, hook the top edge of the cutout on the base of the case over one edge of the DIN rail, then press the opposite side of the cutout containing the release clip over the opposite side of the DIN rail. To remove or reposition the relay, lever the release clip and move the relay as required. WD series relays should be installed in a dry location where the ambient temperature will be within the operating temperature range.

**Maintenance** — WD series protective relays are solid state devices that require no maintenance. They are not designed to be serviced by the user. Consult KILOVAC customer service at 805-220-2023 if repairs should be necessary.

Users should thoroughly review the technical data before selecting a product part number. It is recommended that user also seek out the pertinent approvals files of the agencies/laboratories and review them to ensure the product meets the requirements for a given application.

### Outline Dimensions

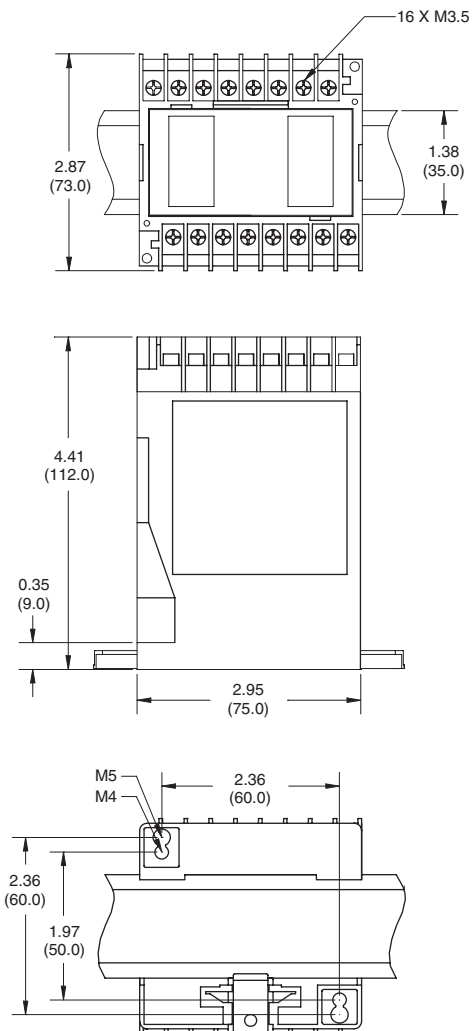

## KILOVAC WD25 Paralleling Relays

### Product Facts

- **Function 25**
- **ANSI/IEEE C37.90-1978**

### WD25 Operation

WD25 paralleling relays are used to ensure that two circuits are synchronized. When voltage, phase relationship and frequency are within the selected synchronizing limits, the output relay will energize. The WD25 paralleling relay allows for a generator to be brought online without damage or system disturbance. WD25 series with a “dead bus” feature will energize for a synchronized condition or an “on line” generator, “dead bus” condition. This “dead bus” feature allows the generator to energize a dead bus. The “double dead bus” feature permits paralleling of two buses when: (a) both the line voltages are equal and in phase, or (b) when either bus is “hot” and the other bus is “dead.”

### Ordering Information

**Typical Part Number** ▶ **WD 25 -00 2**

- 1. Basic Series:** \_\_\_\_\_  
WD = DIN mount Protective Relay.
- 2. Type:** \_\_\_\_\_  
25 = Paralleling Relay.
- 3. Dead Bus:** \_\_\_\_\_  
00 = Double Dead Bus  
01 = Single Dead Bus  
02 = Generator to Generator
- 4. Control Voltage:** \_\_\_\_\_  
1 = 18 to 54VDC  
2 = 13.5 to 32 VDC  
3 = 100-200VDC or 100-140VAC.

**Our authorized distributors are more likely to stock these items.**

WD25-001  
WD25-013

### WD25 Specifications

**Nominal Operating Range** — 120, 208, 277 or 480 VAC, selectable.

**Maximum Sensing Range** — 575VAC.

**Nominal Frequency Range** — 40-400 Hz.

**Contact Form** — 2 form C (DPDT).

### WD25 Calibration

The calibration marks on the faceplate are provided only as guides. Proper calibration requires using an accurate voltmeter. Use the following procedure to calibrate the WD25:

1. Remove the cover.
2. Adjust the SYNC VOLTAGE control fully counterclockwise (CCW). Apply nominal voltage to the LINE B (bus) sensing terminals.
3. Apply the maximum desired synchronization voltage to the LINE A (generator) terminals. This voltage should be in phase with LINE B (bus) voltage and have the same frequency.
4. Slowly adjust the SYNC VOLTAGE control clockwise (CW) until the relay energizes.

### Sense Voltage

Voltage (nominal)	120	208	277	480
Synch Voltage (% of nom.)	6 - 30% (= 4°- 20° electrical degree)			
Dead Bus Voltage (% of nom.)	10 - 70% (Dead Bus)			

### Control Voltage

Model WD25	-0X1	-0X2	-0X3
Input Voltage (VDC)	18 to 54	13.5 to 32	100 to 200
Input Voltage (VAC)	—	—	100 to 140

### WD25 Controls

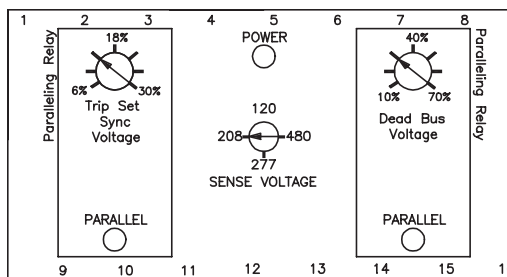

### WD25 Connections

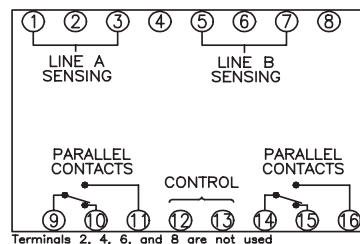

### WD25 Typical Hookup

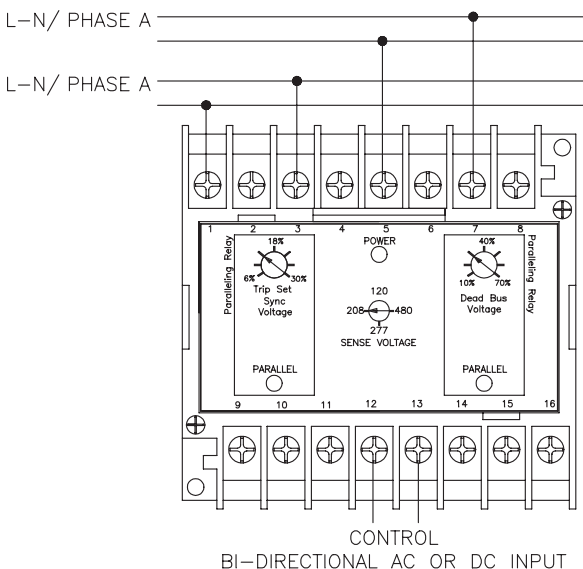

**NOTE:** For single dead bus option, connect the generator to 1 & 3 and the bus to 5 & 7.

## KILOVAC WD2759 Over/Undervoltage Relays

### Product Facts

- Function 27/59
- ANSI/IEEE C37.90-1978

### WD2759 Operation

WD2759 AC voltage sensing relays provide voltage monitoring and protection in AC systems from 50 to 400 Hz. Sensing voltages, number of phases, over and undervoltage setpoint, and time delays are user configured. WD2759 voltage relays operate when the externally adjustable trip point is reached. An external time delay control is provided with an adjustment of .5 to 10 seconds. This time delay may be used to prevent false tripping when there are slight variations in the voltage supply. On overvoltage (OV) the output relay energizes when the input signal exceeds the trip point. On undervoltage (UV) the output relay energizes when the input signal goes below the trip point. A green LED indicates power to the relay. Red LED lights indicate the state of the undervoltage and overvoltage trips.

### Sense Voltage

Voltage (nominal)	120	208	277	480
UV Adjustment Range	72-120	125-208	166-277	288-480
OV Adjustment Range	120-168	208-291	277-388	480-672

### Control Voltage

Model WD2759	-001	-002	-003
Input Voltage (VDC)	18 to 54	13.5 to 32	100 to 200
Input Voltage (VAC)	—	—	100 to 140

### WD2759 Specifications

**Nominal Operating Range** — 120, 208, 277 or 480 VAC, selectable.

**Maximum Sensing Range** — 700VAC.

**Nominal Frequency Range** — 50-400 Hz.

**Contact Form** — 1 form C (SPDT) for undervoltage and 1 form C (SPDT) for overvoltage.

**Time Delay Adjustment** — 0.5 to 10 sec.

### WD2759 Calibration

The calibration marks on the faceplate have a maximum error of 10% and are provided only as guides. Proper calibration requires using an accurate voltmeter in parallel with the input signal. Use the following procedure to calibrate your relay.

#### OVER VOLTAGE

1. Remove cover.
2. Adjust the TRIP SET control fully clockwise (CW) and the TIME DELAY control fully counterclockwise (CCW).
3. Apply the desired trip voltage to the relay.
4. Slowly adjust the TRIP SET control CCW until the relay trips.

5. Remove the applied voltage (do not change the voltage level) and set the TIME DELAY control to the desired time delay.
6. Apply the trip voltage to the relay and measure the time to trip.
7. Adjust the TIME DELAY and repeat steps 4 and 5 until you have the desired time delay.

#### UNDER VOLTAGE

1. Remove cover.
2. Adjust the TRIP SET control fully CCW and the TIME DELAY control fully CCW.
3. Decrease the applied sensing voltage from the nominal value until the desired tripping voltage is reached.
4. Slowly adjust the TRIP SET control CW until the relay trips.
5. Set the TIME DELAY control to the desired time delay and apply nominal voltage to the relay.
6. Step down the applied voltage from nominal to a level just below the trip level set in Step 3 and measure the time delay.
7. Adjust the TIME DELAY and repeat steps 4 and 5 until the desired time delay is achieved.

### Ordering Information

#### Typical Part Number ►

**WD 2759 -002**

**1. Basic Series:** — WD = DIN mount Protective Relay.

**2. Type:** — 2759 = Over/Undervoltage Relay.

**3. Control Voltage:** —  
 001 = 18 to 54VDC  
 002 = 13.5 to 32 VDC  
 003 = 100-200VDC or 100-140VAC.

**Our authorized distributors are more likely to stock these items.**

WD2759-003

**KILOVAC WD2759 Over/Undervoltage Relays** (Continued)

**WD2759 Controls**

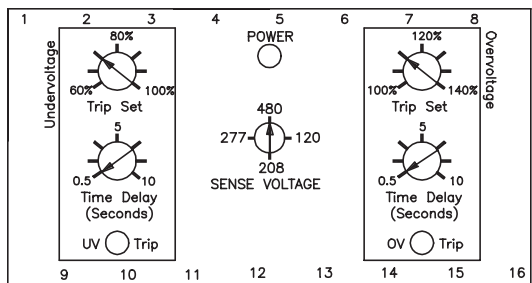

**WD2759 Connections**

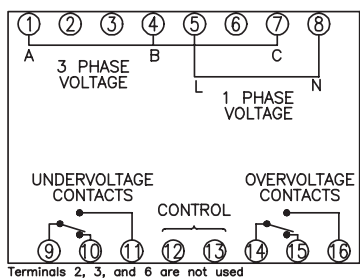

**WD2759 Typical Hookup**

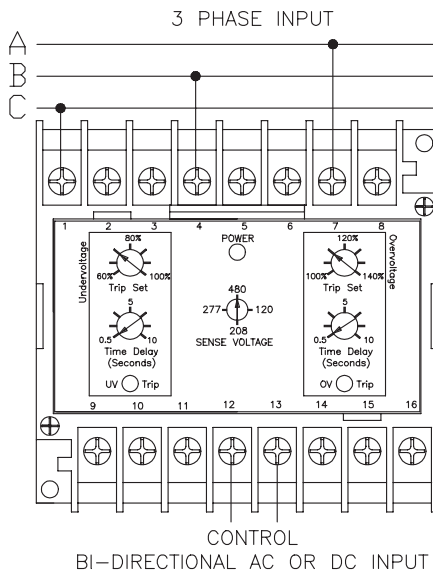
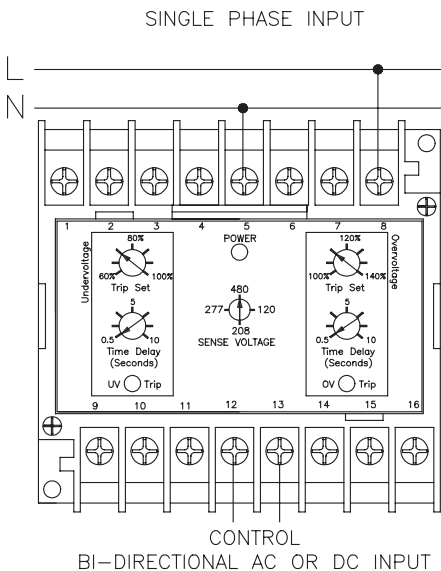

Product Facts

■ Function 32

## KILOVAC WD32 Reverse Power Relays

### WD32 Operation

WD32 reverse power relays are used to monitor the direction of power from AC generators. This is accomplished by measuring  $I \cos \phi$ . If current from the generator is reversed and exceeds the adjustable setting, the relay will trip. A 0.5 to 20 second time delay is provided. A correct setting of the trip point and time delay will prevent motorizing the generator and prevent tripping during transients that occur while synchronizing. A POWER LED indicates the condition of the power supply and a REVERSE POWER TRIP LED indicates the output status of the relay.

### WD32 Specifications

**Nominal Operating Range** — 120 to 480 VAC, 1 or 3 phase.

**Maximum Sensing Range** — 575VAC.

**Nominal Sensing Current** — 5A.

**Nominal Frequency Range** — WD32-00X — 40-400 Hz.; WD32-01X — 60 Hz.

**Contact Form** — 2 form C (DPDT).

**Time Delay Adjustment** — 0.5 to 20 sec.

**Sense Current** — Reverse Power Trip: 0.2 to 1.0A (4-20% of nominal sense current).

### Control Voltage

Model WD32	-001	-002	-003
Input Voltage (VDC)	18 to 54	13.5 to 32	100 to 200
Input Voltage (VAC)	—	—	100 to 140

### WD32 Calibration

The calibration marks on the faceplate have a maximum error of 10% and are provided only as guides. Proper calibration requires using an accurate Current Meter in series with the input current. Use the following procedure to calibrate your relay.

#### REVERSE POWER

1. Remove cover.
2. Adjust the TRIP SET control fully clockwise (CW) and the TIME DELAY control fully counterclockwise (CCW).
3. Apply the desired trip current to the relay. NOTE: for the Reverse Power (WD32-00X) a resistive load must be used and for the Reverse kVAR (WD32-01X) an inductive load must be used.
4. Slowly adjust the TRIP SET control CCW until the relay trips.
5. Remove the applied Current and set the TIME DELAY control to the desired time delay.
6. Re-apply the Current (10% more than the trip current) to the relay and measure the time to trip.
7. Adjust the TIME DELAY and repeat steps 4 and 5 until you have the desired time delay.

### Ordering Information

#### Typical Part Number ▶

**WD 32 -00 2**

**1. Basic Series:** \_\_\_\_\_  
WD = DIN mount Protective Relay.

**2. Type:** \_\_\_\_\_  
32 = Reverse Power Relay.

**3. Load:** \_\_\_\_\_  
00 = Resistive (power)  
01 = Inductive (kVAR, 60 Hz.)

**4. Control Voltage:** \_\_\_\_\_  
1 = 18 to 54VDC  
2 = 13.5 to 32 VDC  
3 = 100-200VDC or 100-140VAC.

**Our authorized distributors are more likely to stock these items.**

WD32-003  
WD32-011

## KILOVAC WD32 Reverse Power Relays (Continued)

### WD32 Controls

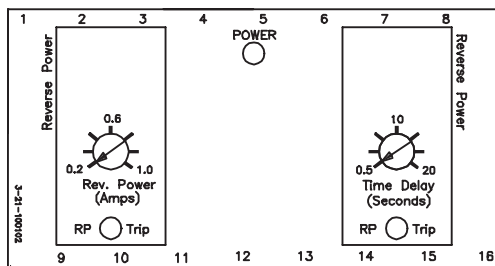

### WD32 Connections

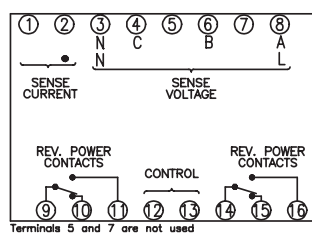

### WD32 Typical Hookup

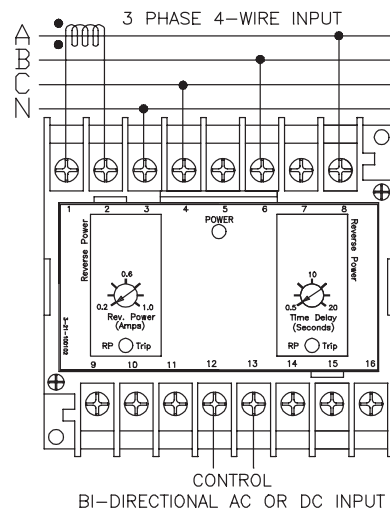
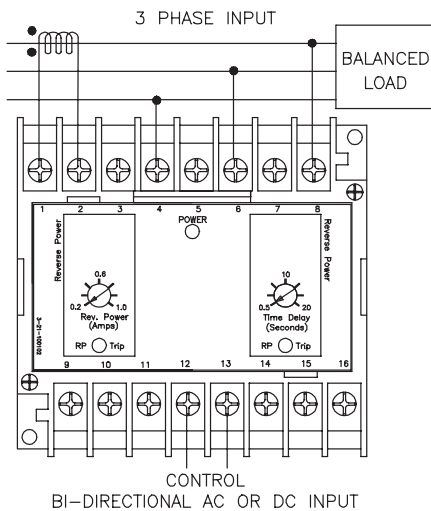
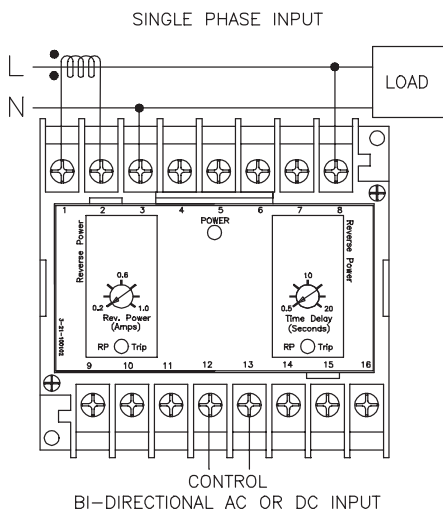

## KILOVAC WD47 Phase Sequence Relays

### Product Facts

- Function 47
- ANSI/IEEE C37.90-1978

### WD47 Operation

WD47 phase sequence relays are designed to monitor the correct phase rotation and loss of phase of three phase ac systems from 50 to 400 Hz. An incorrect phase sequence or loss of any phase will cause the WD47 to pickup. When the phase sequence is corrected or the lost phase is restored the contacts dropout. Red LED's light to indicate a fault condition. A green LED indicates power to the relay. The WD47 is often used to detect reverse phase rotation or loss of phase to generators, busses, motors, and transformers.

### WD47 Specifications

- Nominal Operating Range** — 120 to 480 VAC.
- Maximum Sensing Range** — 575VAC.
- Nominal Frequency Range** — 40-400 Hz.
- Contact Form** — 2 form C (DPDT).

### WD47 Calibration

The WD47 has no adjustments and no calibration is necessary. Proper operation may be verified as follows:

1. Apply a nominal, three-phase input with the correct phase sequence. The output relay should dropout and the green LED should light.
2. Apply a nominal, three-phase input with an incorrect phase sequence. The output relay should pickup and the red LED should light.
3. Apply only one or two phases with the correct phase sequence. The output relay should pickup and the red LED should light.

### Control Voltage

Model WD47	-001	-002	-003
Input Voltage (VDC)	18 to 54	13.5 to 32	100 to 200
Input Voltage (VAC)	—	—	100 to 140

### WD47 Controls

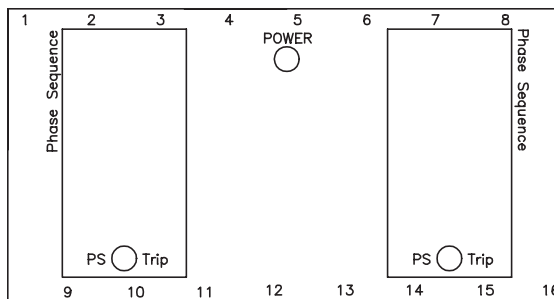

### WD47 Connections

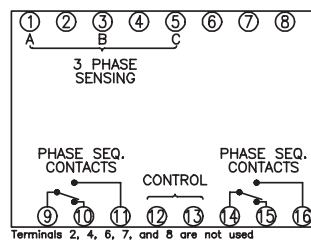

### Ordering Information

#### Typical Part Number ►

- WD 47 -002**
1. **Basic Series:** \_\_\_\_\_  
WD = DIN mount Protective Relay.
  2. **Type:** \_\_\_\_\_  
47 = Phase Sequence Relay.
  3. **Control Voltage:** \_\_\_\_\_  
001 = 18 to 54VDC  
002 = 13.5 to 32 VDC  
003 = 100-200VDC or 100-140VAC.

Our authorized distributors are more likely to stock these items.

WD47-001

### WD47 Typical Hookup

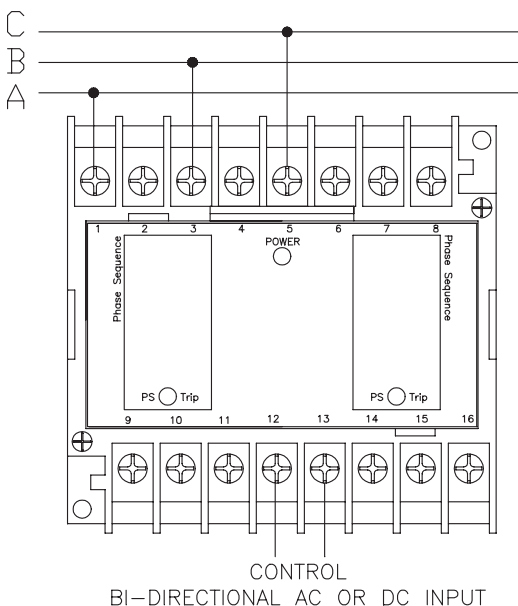



## KILOVAC WD5051 1Ø and 3Ø Overcurrent Relays

### Product Facts

#### ■ Function 5051

### WD5051 Operation

WD5051 AC current sensing relays provide current monitoring and protection in AC systems from 50 to 400 Hz. Nominal Sensing Current, Instantaneous Over Current setpoint, Time Over Current setpoint, and Time Over Current time delay are user configured. WD5051 current relays operate when the externally adjustable trip point is reached. An external time over current time delay control is provided with an adjustment of .5 to 20 seconds. This time delay may be used to prevent false tripping when there are slight variations in the sensed current. With control power applied, the Instantaneous Over Current (IOC) contacts pick-up when the input signal exceeds the IOC trip setpoint. Similarly, with control power applied, the Time Over Current (TOC) contacts pick-up after the preset time delay when the Sense Current rises above the TOC trip setpoint. The IOC contacts may also be configured to function as an under current relay. A green LED indicates power to the relay. Red LED lights indicate the state of the IOC and TOC trips.

### Sense Current

Current (nominal)	1	3	6	8
IOC	0.2 to 1.2	0.6 to 3.6	1.2 to 7.2	1.6 to 9.6
TOC	0.2 to 1.2	0.6 to 3.6	1.2 to 7.2	1.6 to 9.6

### Control Voltage

Model WD5051	-001	-002	-003
Input Voltage (VDC)	18 to 54	13.5 to 32	100 to 200
Input Voltage (VAC)	—	—	100 to 140

### WD5051 Specifications

**Sense Current Full Scale** — 1, 3, 6 or 8A, selectable.

**Maximum Sensing Current** — 10A continuous; 30A for 10 sec.; 60A for 2.5 sec.; 100A for 0.9 sec..

**Nominal Frequency Range** — 50-400 Hz.

**Contact Form** — 1 form C (SPDT) for IOC and 1 form C (SPDT) for TOC.

**TOC Time Delay Adjustment** — 0.5 to 20 sec.

**IOC Operate Time (max.)** — 0.2 sec.

### WD5051 Calibration

The calibration marks on the faceplate are provided only as guides. Proper calibration requires using an accurate ammeter in series with the current source. Use the following procedure to calibrate your relay:

#### OVERCURRENT

1. Remove the cover.
2. Adjust the TRIP SET control fully clockwise (CW) and the TIME DELAY control (TOC only) fully counter-clockwise (CCW).
3. Apply the desired trip current to the relay.
4. Slowly adjust the TRIP SET control CCW until the relay trips.
5. Remove the applied current (do not change the current level). Set the TIME DELAY (TOC only) control to the desired time delay.

### Ordering Information

Typical Part Number ►

**WD 5051 -002**

**1. Basic Series:** —  
WD = DIN mount Protective Relay.

**2. Type:** —  
5051 = Single Phase Overcurrent Relay.  
5051-3 = Three Phase Overcurrent Relay.

**3. Control Voltage:** —  
001 = 18 to 54VDC  
002 = 13.5 to 32 VDC  
003 = 100-200VDC Or 100-140VAC.

**Our authorized distributors are more likely to stock these items.**

WD5051-001  
WD5051-003  
WD5051-3-001

# 11

Protective Relays

## KILOVAC WD5051 1Ø and 3Ø Overcurrent Relays (Continued)

### WD5051 Controls

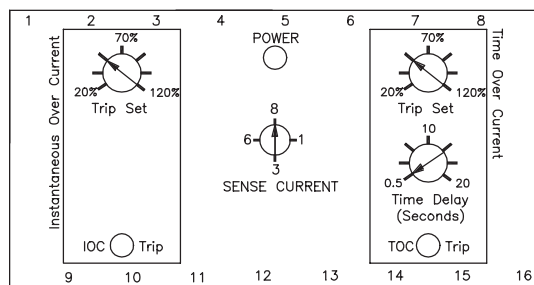

### WD5051 Connections

#### WD5051 Single Phase Model

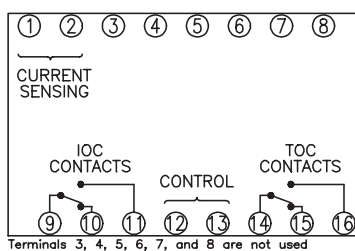

#### WD5051-3 Three Phase Model

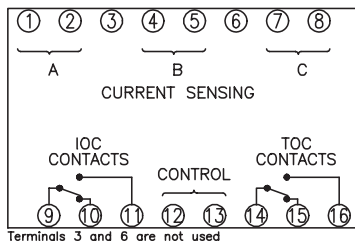

### WD5051 Typical Hookup

#### WD5051 Single Phase Model

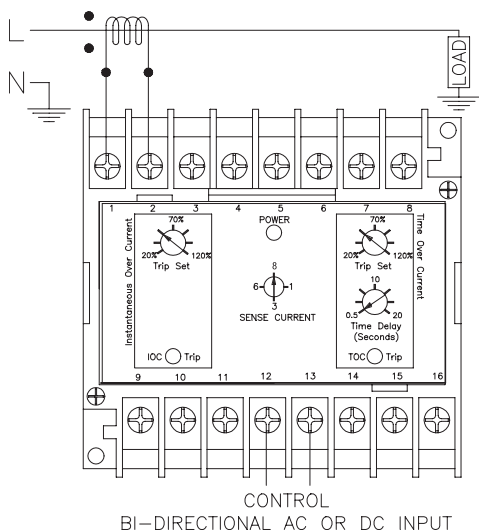

#### WD5051-3 Three Phase Model

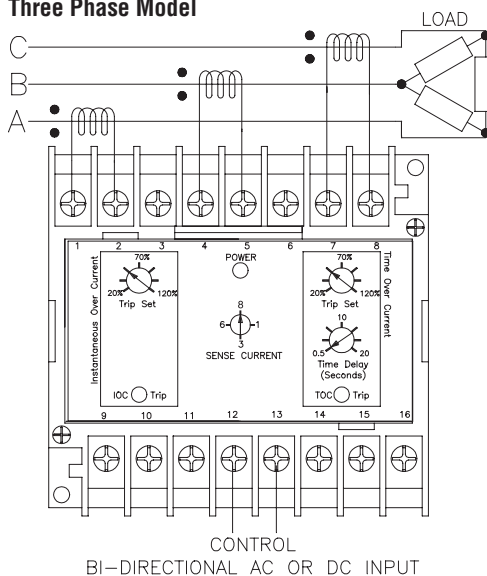

## KILOVAC WD810U Over/Underfrequency Relays

### Product Facts

- **Function 81 0U**
- **ANSI/IEEE C37.90-1978**

### WD810U Operation

WD810U frequency relays are used to provide frequency monitoring and protection to generators, buses, power supplies, and other equipment. The relay operates at voltages from 120 to 480 Vac and at nominal frequencies of 50, 60, and 400 Hz. External controls include nominal frequency selection, under frequency (UF) trip set, over frequency (OF) trip set, UF time delay, and OF time delay. A green LED indicates power to the relay. Red LED's indicate the status of the UF and OF trips.

### WD810U Specifications

**Nominal Operating Frequency** — 50, 60 or 400 Hz., selectable.

**Maximum Frequency @ 400 Hz. Nominal** — 1000 Hz.

**Nominal Sensing Voltage** — 20-480VAC.

**Maximum Sensing Voltage** — 575VAC.

**Contact Form** — 1 form C (SPDT) for underfrequency and 1 form C (SPDT) for overfrequency.

**Time Delay Adjustment** — 0.5 to 10 sec.

### WD810U Calibration

The calibration marks on the faceplate are provided only as guides. Proper calibration requires using an accurate frequency meter in parallel with the input signal.

#### UNDER FREQUENCY

1. Remove the cover.
2. Set the SENSE FREQUENCY to the nominal system frequency. Adjust the Under Frequency TRIP SET fully clockwise (CW) and the TIME DELAY control fully counterclockwise (CCW).
3. Apply the desired trip frequency to the relay.
4. Slowly adjust the TRIP SET control CCW until the relay trips.
5. Set the TIME DELAY control to the desired time delay and apply nominal frequency to the relay.
6. Step down the applied frequency from nominal to just below the trip level set in Step 4 and measure the time delay.
7. Adjust the TIME DELAY and repeat steps 5 and 6 until the desired time delay is set.

#### OVER FREQUENCY

1. Remove the cover.
2. Set the SENSE FREQUENCY to the nominal system frequency. Adjust the OF TRIP SET and TIME DELAY controls fully counterclockwise (CCW).
3. Apply the desired trip frequency to the relay.
4. Slowly adjust the TRIP SET control clockwise (CW) until the relay trips.
5. Set the TIME DELAY control to the desired time delay and apply nominal frequency to the relay.
6. Step down the applied frequency from nominal to just below the trip level set in Step 4 and measure the time delay.
7. Adjust the TIME DELAY and repeat steps 5 and 6 until the desired time delay is set.

### Sense Frequency

Frequency (nominal)	50	60	400
UF Adjustment Range	40-50	48-60	360-400
OF Adjustment Range	50-60	60-72	400-480

### Control Voltage

Model WD810U	-001	-002	-003
Input Voltage (VDC)	18 to 54	13.5 to 32	100 to 200
Input Voltage (VAC)	—	—	100 to 140

### WD810U Controls

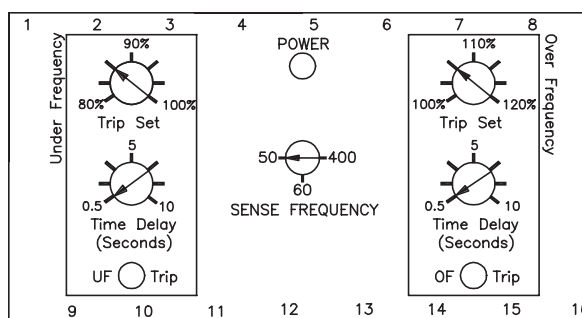

### WD810U Connections

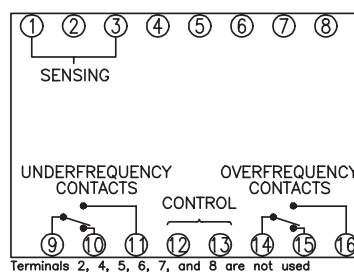

### WD810U Typical Hookup

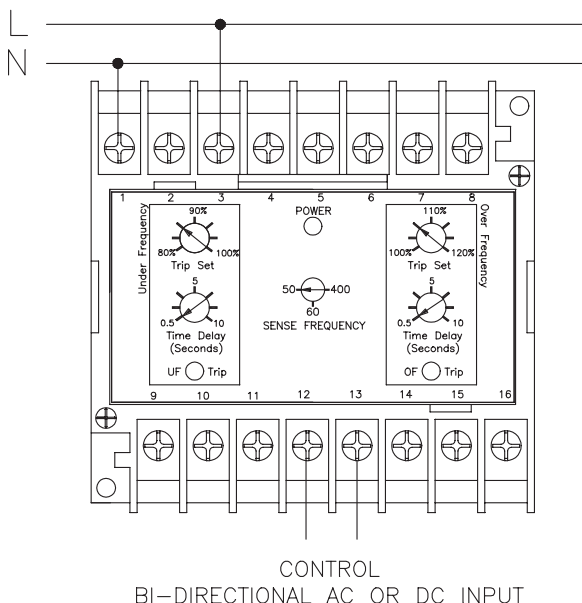

### Ordering Information

#### Typical Part Number ►

**WD 810U-002**

1. **Basic Series:** \_\_\_\_\_  
WD = DIN mount Protective Relay.
2. **Type:** \_\_\_\_\_  
810U = Over/Underfrequency Relay.
3. **Control Voltage:** \_\_\_\_\_  
001 = 18 to 54VDC  
002 = 13.5 to 32 VDC  
003 = 100-200VDC or 100-140VAC.

**Our authorized distributors are more likely to stock these items.**  
None at present.

11

Protective Relays

## WUV/WOV DC Series

### Product Facts

- ANSI/IEEE C37.90-1978

#### Undervoltage Models

The relay is energized at normal voltage, N.C. contacts will open and N.O. contacts will close. The relay will de-energize when the voltage drops below the U/V set point.

#### Overvoltage Models

The relay is de-energized at normal voltage, N.C. contacts are closed and N.O. contacts are open. The relay will energize, when the voltage rises above the O/V set point.

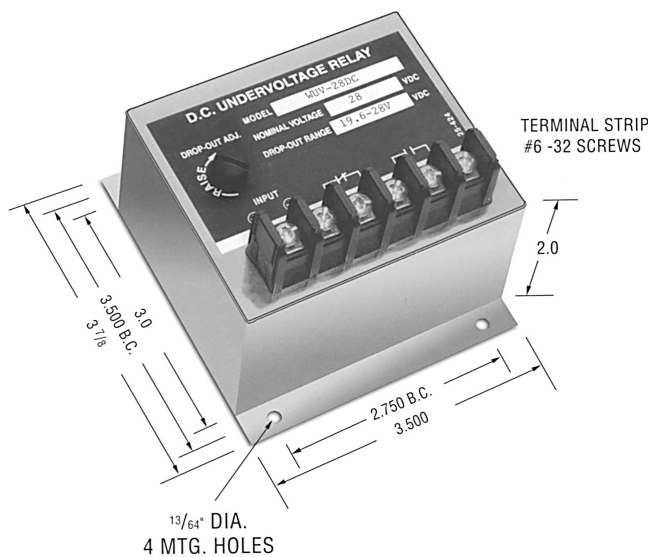

**Note:** Dimensions in inches. Multiply values by 25.4 for dimensions in mm.

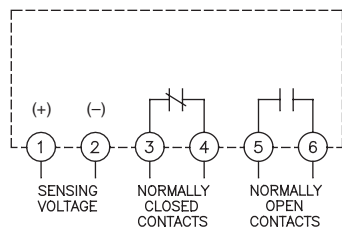

### Product Specifications

**Nominal Voltage** — 12 VDC to 560 VDC

**Drop-out Point (u/v models)** — 70-100% of nominal voltage, screwdriver adjustable

**Pick-Up Point (o/v models)** — 100-125% of nominal voltage, screwdriver adjustable

**Output Contacts** — One set N.O., One set N.C.

**Contact Ratings** — 5 amp resistive at 120 VAC or 28 VDC

**Operating Temperature Range** — -40°C to +75°C

**Temperature Effects** — Less than 1% voltage drift over the temperature range

**Power Consumption** — 12 to 60 VDC models — 1 W max. 120 to 305 VDC models — 2 W max. 405 to 470 VDC models — 3 W max. 560 VDC model — 4 W max.

**Time Delay** — A short duration delay is provided to prevent nuisance tripping due to momentary dips or surges in voltage. The drop-out delay, following a voltage fault is 75 to 100 milliseconds.

#### Notes:

1. Remove black screws for access to the O/V and U/V trip adjustment.
2. Clockwise rotation of the adjustment potentiometer will raise the voltage trip point.
3. The adjustments are by means of a single turn potentiometer. Use a small screwdriver and do not force beyond the limit stops.

### Ordering Information

Sample Part Number ► **WOV-12DC -A**

Type: \_\_\_\_\_  
 WOV - Overvoltage  
 WUV - Undervoltage

Line Voltage VDC \_\_\_\_\_  
 12DC 125DC  
 18DC 240DC  
 24DC 250DC  
 28DC 305DC  
 32DC 405DC  
 48DC 430DC  
 60DC 470DC  
 120DC 560DC

Options: \_\_\_\_\_  
 Blank - Standard  
 A = 2 Form A Contacts  
 B = 2 Form B Contacts  
 H = 125 VDC Contacts  
 P = Transient Protection

Time Curves DC Overvoltage Relays

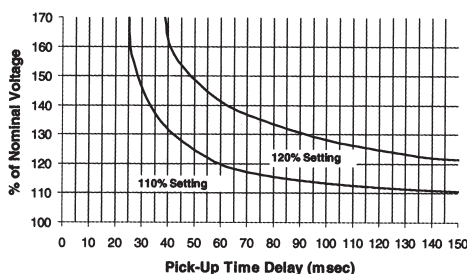



**Transient Protection** — All voltage relays will withstand momentary voltage surges of twice the nominal rated input voltage (standard).

**Option "P"** provides additional transient protection which complies with the requirements of ANSI/IEEE C37.90-1978

**Consult factory for additional models.**

### WUV/WOV Series

**Product Facts**

- Function 27/59
- ANSI/IEEE C37.90-1978
- UL File No. E58048 
- CSA File No. LR61158 

Voltage sensitive relays are available for both AC and DC applications for over/undervoltage protection. Combination over/undervoltage relays provide bandpass capabilities. AC relays are either single or three-phase type. Three phase models are designed to sense the average of the three phases or the highest single phase. Voltage trip points are screwdriver adjustable, and operation is time-delayed so that momentary voltage transients will not cause nuisance tripping.

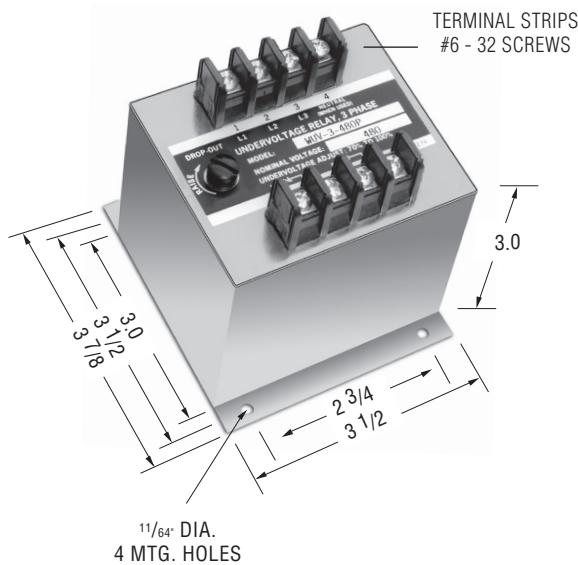

**Note:** Dimensions in inches. Multiply values by 25.4 for dimensions in mm.

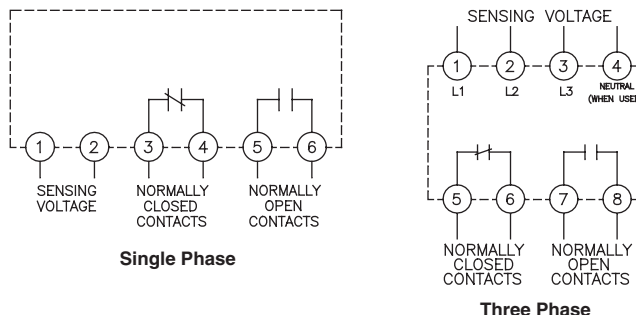

**Product Specifications**

- Nominal Voltage** — 120 VAC to 575 VAC
- Phase** — Single or Three
- Line Frequency** — 50-400 Hz
- Pick-up to Drop-out Differential** — 2.5% maximum
- Drop-out Point (u/v models)** — 70-100% of nominal voltage, screwdriver adjustable
- Pick-Up Point (o/v models)** — 100-125% of nominal voltage, screwdriver adjustable
- Output Contacts** — One set N.O., One set N.C.
- Contact Ratings** — 5 amp resistive at 120 VAC or 28 VDC
- Operating Temperature Range** — -20°C to +65°C
- Power Consumption** — 2 VA maximum
- Time Delay** — 150-300 ms (UV Model)
- Minimum Life** — 500,000 operations

- Notes:**
1. Remove black screw for access to the voltage trip adjustment.
  2. Clockwise rotation of the adjustment potentiometer will raise the voltage trip point.

**Ordering Information**

Sample Part Number ►

WUV -1 -120

**Type:**

WUV - Undervoltage  
WOV - Overvoltage

**No. Phases**

1 = Single  
3 = Three

**Line Voltage VAC**

120 416  
208 440  
220 460  
230 480  
240 525  
380 575

**Options**

- P - Transient Protection
- A - Two Normally Open Contacts
- B - Two Normally Closed Contacts
- H - 125VDC, 3A Contacts

**Typical Time Curve**

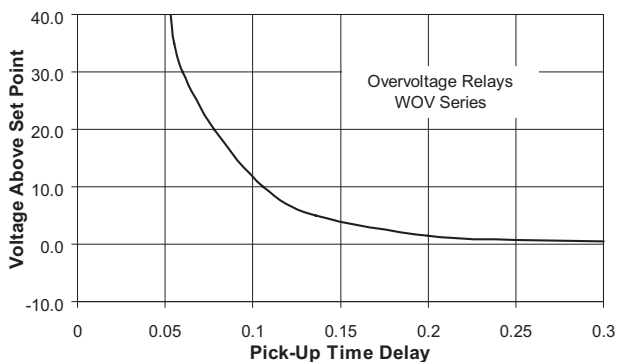

**Transient Protection** — All voltage relays will withstand momentary voltage surges of twice the nominal rated input voltage (standard).



**Option "P"** provides additional transient protection which complies with the requirements of ANSI/IEEE C37.90-1978

**Consult factory for additional models.**



## WUVT/WOVT Series

### Product Facts

- Function 27/59
- ANSI/IEEE C37.90-1978
- UL File No. E58048 
- CSA File No. LR61158 

### Undervoltage Models

The relay is energized at normal voltage, N.C. contacts will open and N.O. contacts will close. The relay will de-energize when the voltage drops and remains below the U/V set point for the duration of the set time delay.

### Overvoltage Models

The relay is de-energized at normal voltages, N.C. contacts are closed and N.O. contacts are open. The relay will energize, when the voltage rises and remains above the O/V set point for the duration of the set time delay.

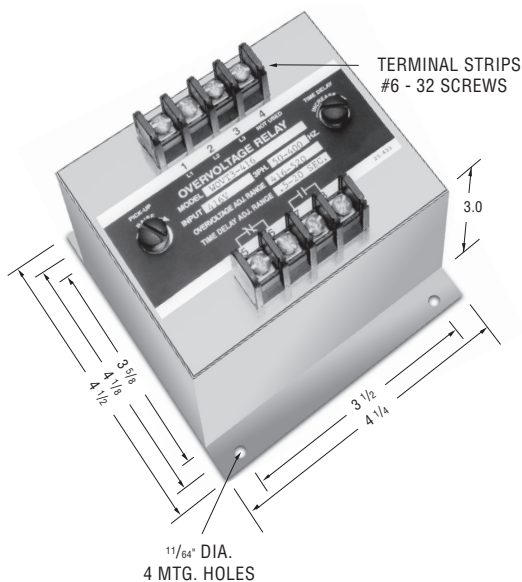

**Note:** Dimensions in inches. Multiply values by 25.4 for dimensions in mm.

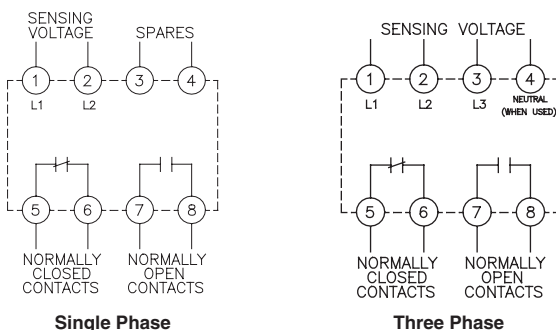

### Product Specifications

**Nominal Voltage** — 100 VAC to 575 VAC

**Phase** — Single or Three

**Line Frequency** — 50-400 Hz

**Pick-up to Drop-out Differential** — 1% typical

**Drop-out Point (u/v models)** — 70-100% of nominal voltage, screwdriver adjustable

**Pick-Up Point (o/v models)** — 100-125% of nominal voltage, screwdriver adjustable

**Output Contacts** — One set N.O., One set N.C.

**Contact Ratings** —

5 amp resistive at 120 VAC or 28 VDC

**Operating Temperature Range** — -40°C to +70°C

**Power Consumption** — 3 VA maximum

**Time Delay** — 0.5 to 20 seconds, screwdriver adjustable

**Voltage Reset** — The reset is automatic when voltage returns to normal.

### Notes:

1. Remove black screws for access to the voltage and time delay adjustment potentiometer.
2. Clockwise rotation of the voltage adjust potentiometer will raise the voltage trip point.
3. Clockwise rotation of the time adjust potentiometer will increase the time delay (Pick-up time for O/V models, drop-out time for U/V models).
4. The adjustments are single turn potentiometers, use a small screwdriver and do not force beyond the limit stops.
5. On U/V models, when the voltage falls to approximately 33% of nominal or below, the relay will drop out in 0.150 to 0.300 seconds, regardless of the time delay setting.

### Ordering Information

<b>Sample Part Number</b> ▶	WUVT	-1	-120
<b>Type:</b>	WUVT - Undervoltage WOVT - Overvoltage		
<b>No. Phases</b>	1 = Single 3 = Three (line to line)		
<b>Line Voltage VAC</b>	100 240 115 380 120 416 150 440 200 460 208 480 220 525 230 575		

### Options:

- Blank - Standard
- A = 2 Form A Contacts
- B = 2 Form B Contacts
- H = 125VDC 3A Contacts
- P = Transient Protection

**Transient Protection** — All voltage relays will withstand momentary voltage surges of twice the nominal rated input voltage (standard).

**Option "P"** provides additional transient protection which complies with the requirements of ANSI/IEEE C37.90-1978

**Consult factory for additional models.**



## WOUV DC Series, Over/Undervoltage

### Product Facts

- ANSI/IEEE C37.90-1978

The relay will energize at normal voltage conditions. The normally open contacts will close, and the normally closed contacts will open. The relay will de-energize during over or undervoltage conditions. Reset is automatic when the voltage returns to normal.

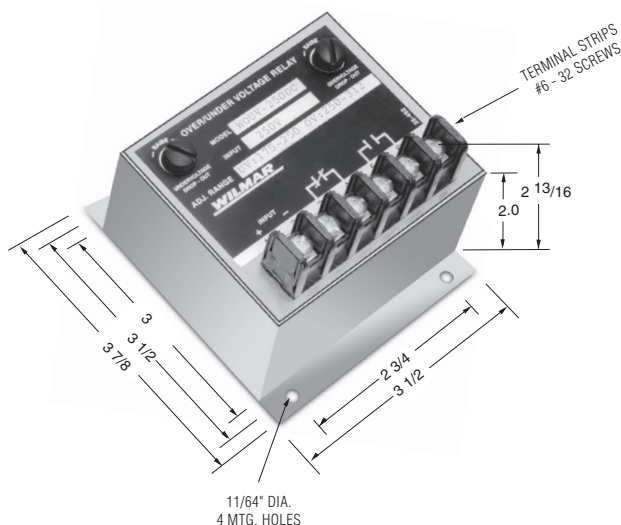

**Note:** Dimensions in inches. Multiply values by 25.4 for dimensions in mm.

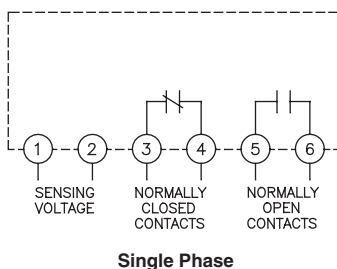

### Product Specifications

**Nominal Voltage ( $\pm 10\%$ )** — 12 VDC to 560 VDC

**Drop-out Point (u/v models)** — 70-100% of nominal voltage, screwdriver adjustable

**Pick-Up Point (o/v models)** — 100-125% of nominal voltage, screwdriver adjustable

**Output Contacts** — One set N.O., One set N.C.

**Contact Ratings** —

5 amp resistive at 120 VAC or 28 VDC

**Operating Temperature Range** —  $-40^{\circ}\text{C}$  to  $+75^{\circ}\text{C}$

**Temperature Effects** —

Less than 1% voltage drift over the temperature range.

**Power Consumption** —

12 to 60 VDC models — 1 W max.

120 to 305 VDC models — 2 W max.

405 to 470 VDC models — 3 W max.

560 VDC Model — 4 W max.

**Time Delay** — A short duration delay is provided to prevent nuisance tripping due to momentary dips or surges in voltage. The drop-out delay, following a voltage fault is 75 to 100 milliseconds

### Notes:

- Remove black screws for access to the O/V and U/V trip adjustment.
- Clockwise rotation of the adjustment potentiometer will raise the voltage trip point.
- The adjustments are by means of a single turn potentiometer. Use a small screwdriver and do not force beyond the limit stops.

### Ordering Information

Sample Part Number	▶	<b>WOUV -12DC</b>	<b>-A</b>
Type:		WOUV - Over/Undervoltage	
Line Voltage VDC		12DC    125DC	
		18DC    240DC	
		24DC    250DC	
		28DC    305DC	
		32DC    405DC	
		48DC    430DC	
		60DC    470DC	
		120DC   560DC	
Options:		Blank - Standard	
		A = 2 Form A Contacts	
		B = 2 Form B Contacts	
		H = 125 VDC Contacts	
		P = Transient Protection	

Drop-Out Time Delay WOUV...DC Series

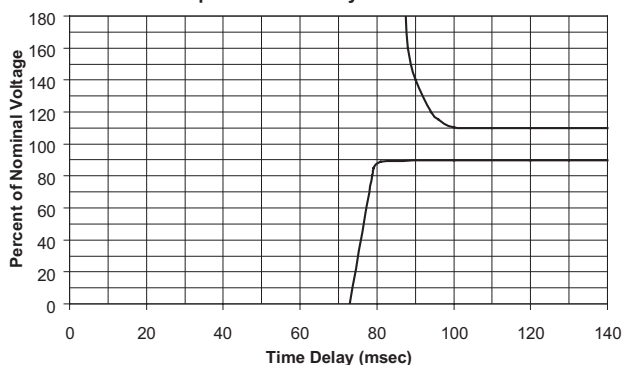

**Transient Protection** — All voltage relays will withstand momentary voltage surges of twice the nominal rated input voltage (standard).

**Option "P"** provides additional transient protection which complies with the requirements of ANSI/IEEE C37.90-1978

**Consult factory for additional models.**

## WOUVT Series, Over/Undervoltage

### Product Facts

- Function 27/59
- ANSI/IEEE C37.90-1978

Voltage sensitive relays are available for both AC and DC applications for overvoltage and undervoltage protection. Combination over/undervoltage relays provide band-pass capabilities. AC relays are either single or three-phase type. Three phase relays are designed to sense the average of the three phases. Voltage trip points are screwdriver adjustable, and operation is time-delayed so that momentary voltage transients will not cause nuisance tripping.

### Operation

The relay will energize at normal voltage condition. The normally closed contact (Form B) will open and the normally open (Form A) will close. The relay will de-energize after time delay when over or undervoltage condition is reached.

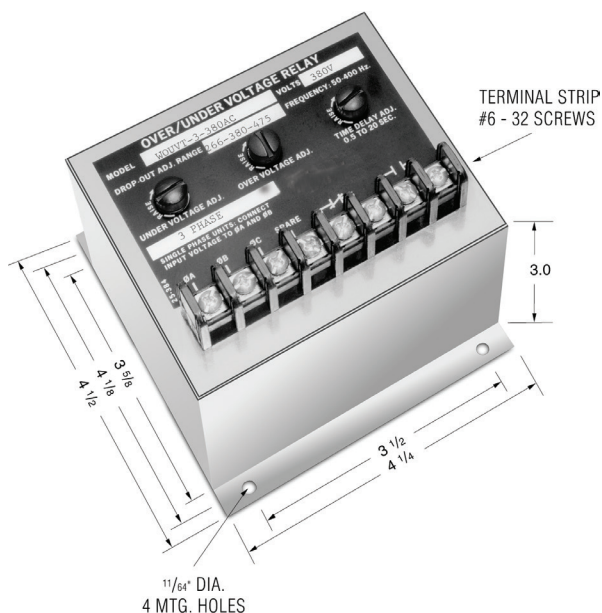

### Product Specifications

**Nominal Voltage** — 120 VAC to 575 VAC

**Phase** — Single or Three

**Line Frequency** — 50-400 Hz

**Type of Sensing** — Average of all three phases

**Undervoltage Trip** — 70-100% of nominal voltage, screwdriver adjustable

**Overvoltage Trip** — 100-125% of nominal voltage, screwdriver adjustable

**Drop-out Time Delay** — 0.5 to 20 seconds, screwdriver adjustable

**Pick-up to Drop-out Differential** — 2% maximum

**Output Contacts** — One set N.O., One set N.C.

**Contact Ratings** — 5 amp resistive at 120 VAC or 28 VDC

**Operating Temperature Range** — -40°C to +70°C

**Power Consumption** — 4 VA maximum

### Notes:

1. Remove black screw for access to the voltage trip and time delay adjustment potentiometer.
2. Clockwise rotation of the voltage adjustment potentiometer will raise the voltage trip point.
3. Clockwise rotation of the time adjustment potentiometer will increase the drop-out time delay.

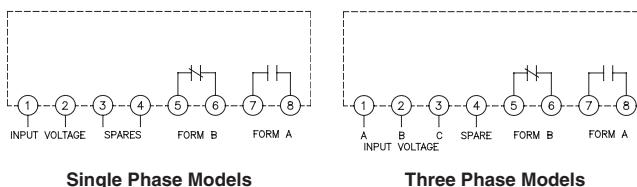

### Ordering Information

Sample Part Number ► **WOUVT -1 -120AC**

**Type:** \_\_\_\_\_  
WOUVT - Over/Undervoltage

**No. Phases** \_\_\_\_\_  
1 = Single  
3 = Three (line to line)

**Line Voltage VAC** \_\_\_\_\_

- 115
- 120
- 200
- 208
- 220
- 230
- 240
- 380

### Options:

- Blank - Standard
- A = 2 Form A Contacts
- B = 2 Form B Contacts
- H = 125 VDC Contacts
- P = Transient Protection

**Option "H"** provides for contacts rating of 3 amps @ 125VDC.

**Option "P"** provides additional transient protection which complies with the requirements of ANSI/IEEE C37.90-1978

**Consult factory for additional models.**



## 250 Series, Over/Undervoltage

### Product Facts

- Function 27/59
- ANSI/IEEE C37.90-1978

The 250 series relays provide combined Overvoltage and Undervoltage protection in a single compact unit.

Models are available for single phase or three phase applications, and are suitable for either 50 Hz, 60 Hz, or 400 Hz operation. The trip point is adjustable.

A transistorized circuit provides a sharp and accurate response at the preset tripping voltage; unaffected by temperature or frequency variations.

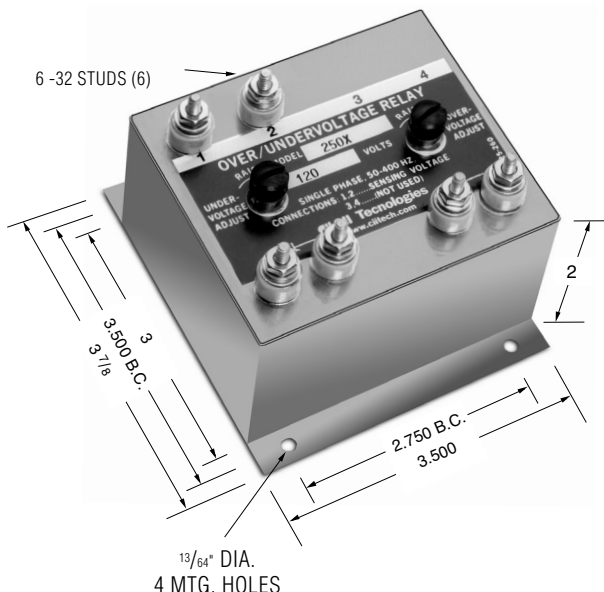

**Note:** Dimensions in inches. Multiply values by 25.4 for dimensions in mm.

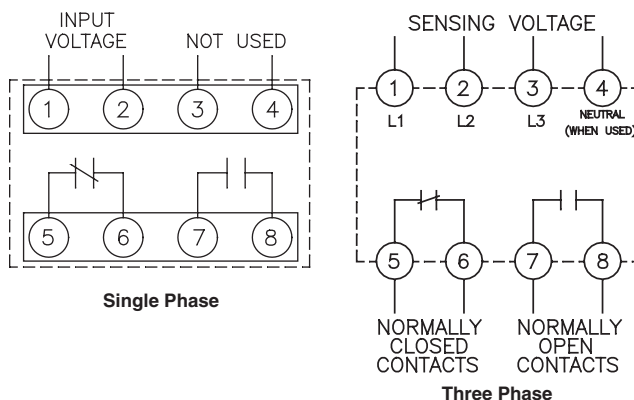

### Product Specifications

**Nominal Voltage** — See Ordering Information

**Undervoltage Trip** — 70-100% of nominal voltage, screwdriver adjustable

**Overvoltage Trip** — 100-125% of nominal voltage, screwdriver adjustable

**Pick-up to Drop-out Differential** — 3% maximum

**Contact Ratings** — 5 amp resistive at 120 VAC or 28 VDC

**Contact Form** — One set N.O., one set N.C.

**Operating Temperature Range** — -20°C to +85°C

### Notes:

1. Remove screws for access the overvoltage or undervoltage trip adjustments. Clockwise rotation of the adjustment potentiometer will raise the trip point.

### Contact Arrangements

**NC** — Open at nominal voltage. Closed at Overvoltage and Undervoltage

**NO** — Closed at nominal voltage. Open at Overvoltage and Undervoltage

11

Protective Relays

### Ordering Information

Sample Part Number ►

Model: L-L Volts

- 250X = 120 VAC, 1 Phase, 50-400 Hz
- 251X = 120/208 VAC, 3 Phase, 4 Wire, 50-400 Hz
- 252X = 115 VAC, 3 Phase, 3 Wire, 50-400 Hz
- 253X\* = 230 VAC, 3 Phase, 3 Wire, 50-400 Hz
- 254X\* = 380 VAC, 3 Phase, 3 Wire, 50-400 Hz
- 255X\* = 460 VAC, 3 Phase, 3 Wire, 50-400 Hz
- 256X\* = 575 VAC, 3 Phase, 3 Wire, 50-400 Hz

Mounting



- Blank = Stud
- X = Flange

\* Enclosure height is 3.835"

Consult factory for additional models.

## D100X Series, Close Differential

### Product Facts

- ANSI/IEEE C37.90-1978
- UL File No. E58048 
- CSA File No. LR61158 

Close Differential Relays are voltage sensitive. The pick-up and drop-out voltage settings are independently adjustable, which allows precise setting of the differential voltage. This relay is available in a wide range of AC and DC voltages. Their primary application is the sensing and control of transfer switches.

### Operation

Monitors a single phase AC signal, and is used for undervoltage detection. Has separate pick-up and drop-out voltage settings, providing an adjustable hysteresis.

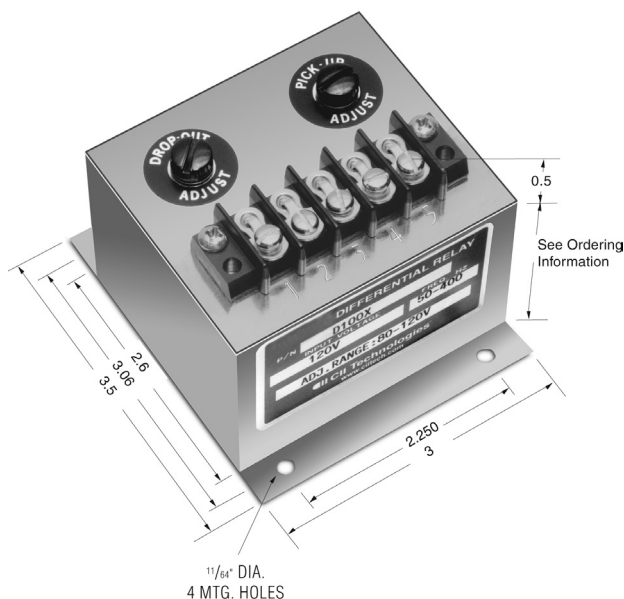

**Note:** Dimensions in inches. Multiply values by 25.4 for dimensions in mm.

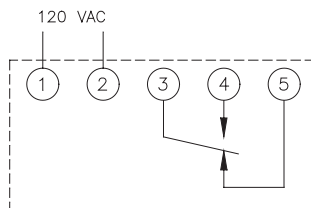

### Product Specifications

- Nominal Voltage** — AC, Single Phase, see Ordering Information
- Nominal Frequency** — 50 to 400 Hz.
- Pick-Up Adjustment Range** — 67-100% of nominal voltage
- Drop-Out Adjustment Range** — 67-100% of nominal voltage
- Maximum Differential Setting** — 33% of nominal voltage
- Minimum Differential Setting** — 2% of nominal voltage
- Output Contacts** — Form C (SPDT)
- Contact Ratings** — 5 Amp resistive at 120 VAC or 28 VDC
- Operating Temperature Range** — -20°C to +85°C
- Expected Life** — 10 million operations
- Inverse Time Drop-Out** — The differential relay contains a time delay before operation so that momentary voltage transients do not affect the operation of the relay. The time delay has an inverse time characteristic so that excessive voltage conditions will cause a more rapid drop-out. This time delay is approximately 200mSec. (12 cycles) at the trip settings and decreases to 30 mSec. at approximately 15% beyond the trip settings.

### Notes:

1. Remove black nylon protective screws to gain access to the two internal adjustment potentiometers.
2. Clockwise rotation of the pick-up and drop-out adjustment will raise the voltage trip point.
3. The relay contacts are shown in the de-energized state.

### Ordering Information

<b>Sample Part Number</b> ▶	<b>D100X</b>	
<b>Model: L-L Volts</b>	_____	<b>Height</b>
D100X = 120 VAC		2"
D100-6X = 120 VAC, Spike Suppression		2"
D100-3X = 208 VAC		3.125"
D100-4X = 240 VAC		3.125"
D100-8X = 277 VAC		3.125"
D100-5X = 480 VAC		3.125"
D100-7X = 510 VAC		3.125"

Surge Withstand Capability is in compliance with the requirements of ANSI/IEEE C37.90B

**Consult factory for additional models.**

## D101X Series, 3 Phase Adjustable, Close Differential

### Product Facts

- ANSI/IEEE C37.90-1978
- UL File No. E58048
- CSA File No. LR61158



Close Differential Relays are voltage sensitive. The pick-up and drop-out voltage settings are independently adjustable, which allows precise setting of the differential voltage. This relay is available in a wide range of AC voltages. Their primary application is the sensing and control of transfer switches.

### Operation

The output contacts will close when the voltage of all three phases is above the pre-set pick-up point, and will open when any one phase drops below its drop-out setting.

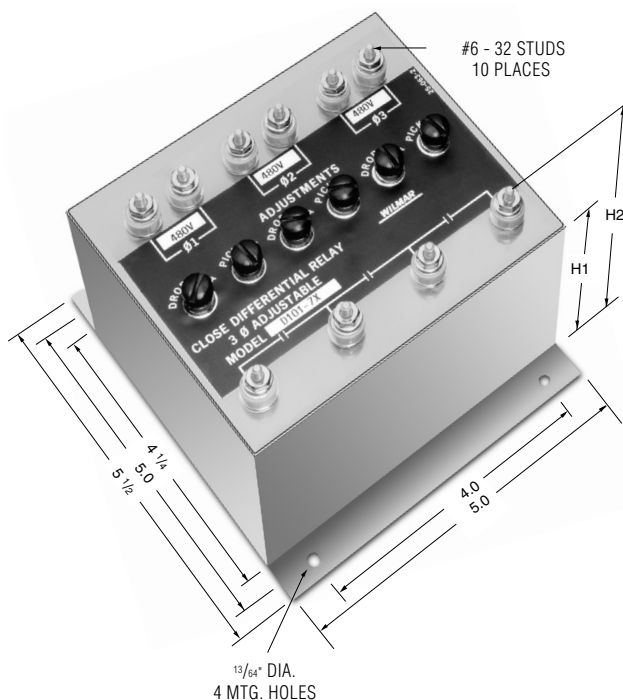

### Product Specifications

**Nominal Voltage** — AC, Three Phase, see Ordering Information

**Nominal Frequency** — 50 to 500 Hz.

**Pick-Up Adjustment Range** — 66-100% of nominal voltage, screw-driver adjustable

**Drop-Out Adjustment Range** — 66-100% of nominal voltage, screw-driver adjustable

**Output Contacts** — SPNO

**Contact Ratings** — 5 amp resistive at 120 VAC or 28 VDC

**Operating Temperature Range** — -20°C to +85°C

### Notes:

1. Remove screws for access to pick-up and drop-out trip adjustments.
2. Clockwise rotation of the pick-up and drop-out adjustment will raise the voltage trip point.

**Note:** Dimensions in inches. Multiply values by 25.4 for dimensions in mm.

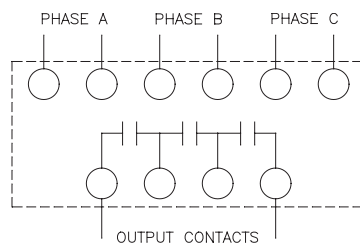

### Ordering Information

Sample Part Number ► **D101X**



- Model: L-L Volts**
- D101X = 120 VAC
  - D101-6X = 208 VAC
  - D101-4X = 240 VAC
  - D101-10X = 380 VAC
  - D101-7X = 480 VAC

Model	Power Consumption Each Phase	H1 (inches)	H2 (inches)
D101X	2 VA max.	2	2 11/16
D101-4X	3 VA max.	3 1/2	4 3/16
D101-6X	3 VA max.	3 1/2	4 3/16
D101-7X	4 VA max.	3 1/2	4 3/16
D101-10X	4 VA max.	3 1/2	4 3/16

Consult factory for additional models.

## 700 Series w/ Adjustable Time Delay

### Product Facts

- Function 32
- ANSI/IEEE C37.90-1978
- UL File No. E58048 
- CSA File No. LR61158 

Several types of Reverse Power Relays are available including relays sensitive to reverse reactive power (kVAR). KILOVAC is the leading brand of reverse power relays. Our rugged sealed construction provides continuous and reliable operation unaffected by shock, vibration or other severe environments. Reverse Power Relays are used for the protection of generator sets operating in parallel.

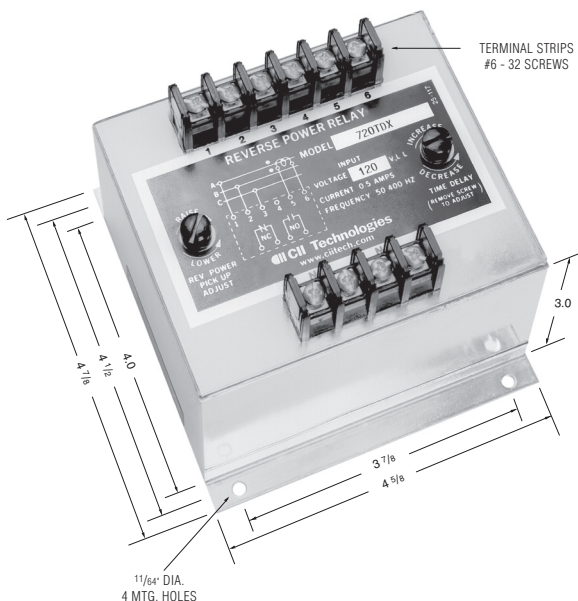

**Note:** Dimensions in inches. Multiply values by 25.4 for dimensions in mm.

**Model 710TD**

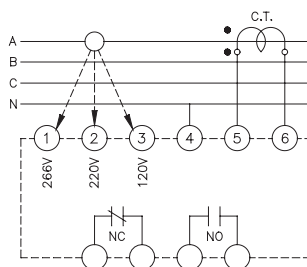

Designed for 120, 220 or 266 volt line to neutral connection

**Model 720TD (X) thru 724TD (X)**

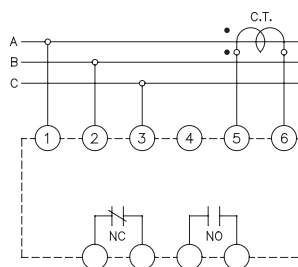

For operation on three phase, three wire

### Ordering Information

Sample Part Number ▶

**720TDX**

Type:

- 710TD = 120V, 220V, 266V line to neutral
- 720TD = 120V, L-L, 3 Phase
- 721TD = 230V, L-L, 3 Phase
- 722TD = 380V, L-L, 3 Phase
- 723TD = 460V, L-L, 3 Phase
- 724TD = 575V, L-L, 3 Phase
- 725TD = 416V, L-L, 3 Phase
- 730TD = 120 V, 230 V, 380 V, 460 V, L-L, 3 Phase or 120 V, Single Phase, L-N

Mounting:

- X = Flange
- Blank = Stud

Options:

- 7 = Reverse Inductive, 60 Hz

### Product Specifications

#### Line Voltage —

Model 710TD — 120 V, 220 V or 266 V, line to neutral  
 Model 730TD — 120 V, 230 V, 380 V, 460 V, L-L, 3 Phase or 120 V, Single Phase, L-N

All models for three phase, three wire sensing are available, see Ordering Information

**Line Frequency** — 50-500 Hz.

#### Current Requirements —

0 to 5 amp max direct or from CT with 5 amp secondary

#### Trip Adjustment —

Screwdriver adjustable 4% to 20% (of the 5 amp rating)

**Time Delay Adjustment** — 0.5 to 20 seconds, screwdriver adjustable

**Output Contacts** — One set N.O., one set N.C.

**Contact Ratings** — 5 amp resistive at 120 AC or 28 Vdc

#### Power Consumption —

Voltage circuit — 2 VA max.  
 Current circuit — 4 VA max.

**Weight** — 2.75 lbs. max.



#### Notes:

1. Remove screw for access to the pick-up and time delay adjustments.
2. Clockwise rotation of the pick-up adjustment will raise the reverse trip point.
3. Clockwise rotation of the time adjustment will increase the time delay.
4. Polarity of the voltage and the current connections must be observed for true power sensing.
5. Interchanging connections on terminals 5 and 6, will cause the output contacts to pick-up on forward power and dropout on no power or reverse power.

Consult factory for additional models.

### 1000 Series

**Product Facts**

- Function 47
- ANSI/IEEE C37.90-1978
- UL File No. E58048 
- CSA File No. LR61158 

Phase failure relays protect motors, equipment and personnel from damage or injury caused by open phase, reversed phase sequence, or low voltage in a three phase system. Models are available for 50 and 60 Hz with voltages up to 575 volts. Motor control switchboards are a common application.

**Operation**

The contacts of the relay will close only when it senses normal conditions of three phase power at the proper phase sequence.

The relay contacts will remain in their normally open position (de-energized) when voltage with incorrect phase sequence is applied, one or more phases are open, or at undervoltage condition.

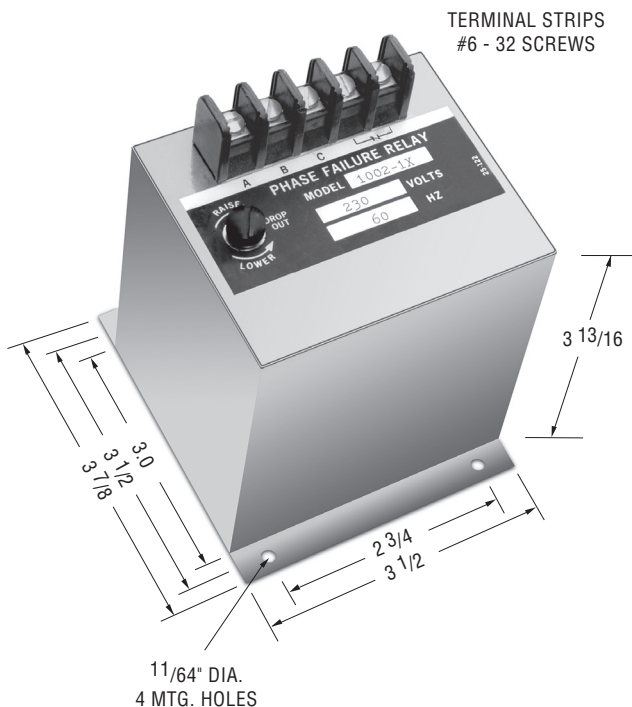

TERMINAL STRIPS  
#6 - 32 SCREWS

**Product Specifications**

- Nominal Voltage** — See Ordering Information
- Voltage Drop-Out** — 75% to 100% of nominal, screwdriver adjustable
- Pick-Up to Drop-Out Differential** — 3% approx.
- Ambient Operating Temperature** — -40°C to +70°C
- Temperature Drift** — ± 1%
- Time Delay** — See Curve
- Output Contacts** — One set, normally open
- Contact Ratings** —  
10 amp at 28 VDC resistive  
10 amp at 230 VAC resistive

**Notes:**

1. Remove screw for access to the undervoltage adjustment.
2. Clockwise rotation of the adjustment potentiometer will raise the drop-out voltage.

**Note:** Dimensions in inches. Multiply values by 25.4 for dimensions in mm.

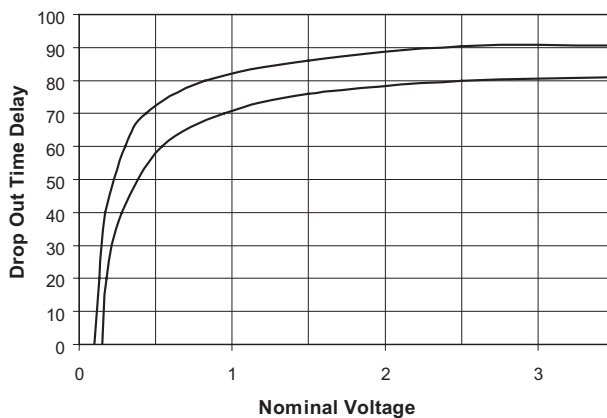

**Ordering Information**

Sample Part Number ►

1004X

Type:

- 1001 = 120 V, 60 Hz, 3 phase, L-L
- 1007 = 208 V, 60 Hz, 3 phase, L-L
- 1002 = 230 V, 60 Hz, 3 phase, L-L
- 1012 = 300 V, 60 Hz, 3 phase, L-L
- 1013 = 350 V, 60 Hz, 3 phase, L-L
- 1003 = 380 V, 50 Hz, 3 phase, L-L
- 1004 = 460 V, 60 Hz, 3 phase, L-L
- 1005 = 525 V, 60 Hz, 3 phase, L-L
- 1006 = 575 V, 60 Hz, 3 Phase, L-L

Mounting:

- X = Flange
- Blank - Stud

Consult factory for additional models.

## 900 Series

### Product Facts

#### ■ Function 47

Phase sequence relays are designed to monitor the correct phase rotation of a three phase system. Several models are available from 50 Hz, 60 Hz, and 400 Hz with voltages up to 575 volts. High shock relay output and reverse contacts are also available.

#### Operation

The relay remains de-energized when voltage in the proper phase sequence (A, B, C) is applied, the relay is energized when voltage with incorrect sequence (A, C, B) is applied.

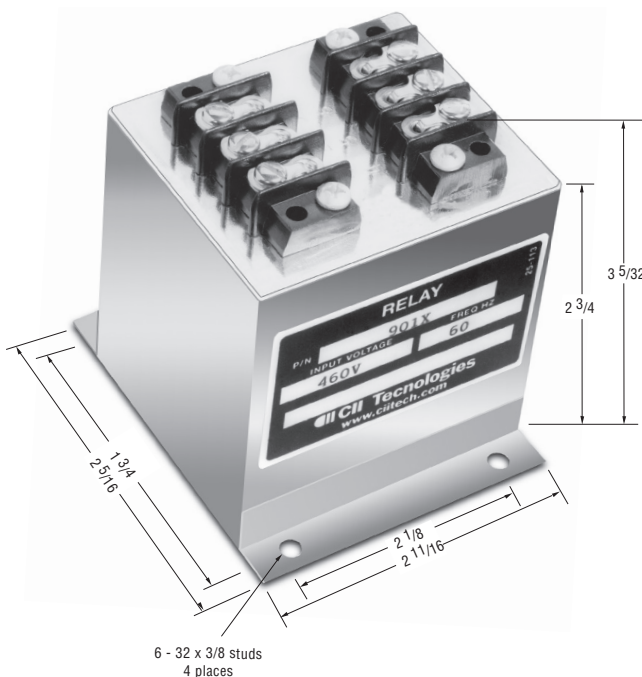

### Product Specifications

**Input Voltage** — See Ordering Information

**Output Contacts** — SPDT

**Contact Ratings** — 5 amp resistive at 120 Vac or 28 Vdc

**Note:** Dimensions in inches. Multiply values by 25.4 for dimensions in mm.

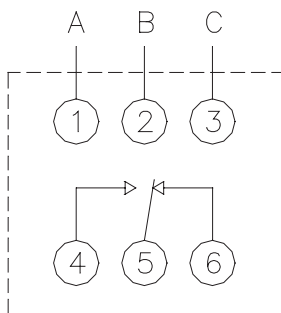

### Ordering Information

Sample Part Number ►

901X

Type: \_\_\_\_\_

- 900-3X = 120 VAC, 60 Hz, 3 phase, L-L
- 910X = 190-520 VAC, 60 Hz, 3 Phase, L-L
- 900-2X = 208-230, 50/60 Hz, 3 Phase
- 900X = 230 VAC, 60 Hz, 3 phase, L-L
- 901X = 460 VAC, 60 Hz, 3 phase, L-L

Mounting: \_\_\_\_\_



- X = Flange
- Blank - Stud

Consult factory for additional models.



WCB Series

Product Facts

- Function 60 or 87
- ANSI/IEEE C37.90-1978
- UL File No. E58048 
- CSA File No. LR61158 

Current Balance Relays are designed to sense unbalanced current flow in a three phase system. The primary application of Current Balance Relays is to protect three phase motors against phase unbalance or phase failure.

Operation

With control voltage applied to the relay, the output contacts will energize when the three phase currents are balanced (including zero currents), and will be de-energize by unbalance currents.

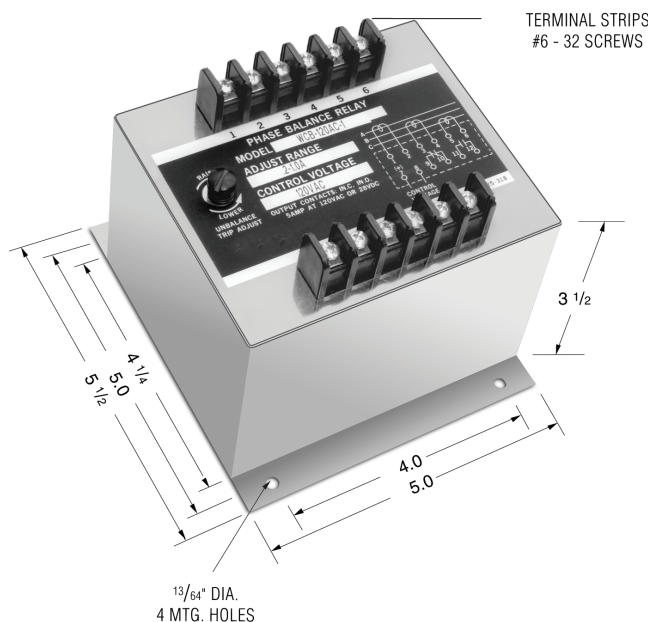

Note: Dimensions in inches. Multiply values by 25.4 for dimensions in mm.

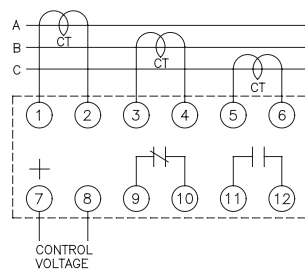

Product Specifications

**Line Current** — Three Phase, AC current, 50-400 Hz Direct or from CT.  
 5 amp continuously  
 20 amp, 30 sec.  
 200 amp, 0.10 sec.

**Control Voltage** — See Ordering Information

**Unbalanced Trip Point** — Screwdriver adjustable. Adjustment range in accordance with ordering information. (The unbalanced value is defined as the difference between the highest and the lowest phase current).

**Drop-Out Time Delay** — 0.9 to 1.3 seconds

**Surge Withstand Capability** — In compliance with C37.90B ANSI/IEEE

**Operating Temperature** — -40°C to +70°C

**Burden** — Current input — 5.0 VA, Phase Control voltage — 3.0 VA

**Contact Ratings** — One set, N.O., One set N.C. 5 amp resistive at 120 VAC or 28 VDC

Notes:

1. Remove black screw for access to the trip adjustment.
2. Clockwise rotation of the adjustment potentiometer will raise the unbalance trip point.
3. The output contacts are shown de-energized.

Ordering Information

Sample Part Number ► **WCB -120AC -1 -A**

**Type:** \_\_\_\_\_  
 WCB = Current Balance



**Control Voltage (± 15%)** \_\_\_\_\_  
 26 DC  
 48 DC  
 125 AC  
 120 AC  
 230 AC  
 380 AC  
 460 AC

**Trip Adjustment Range** \_\_\_\_\_  
 .5 = 0.1 amp to 0.5 amps  
 1 = 0.2 amp to 1 amp  
 2 = 0.4 amp to 2 amp

**Options:** \_\_\_\_\_  
 A = two normally open contacts  
 B = two normally closed contacts

## WC1 & WCT1 Series, Overcurrent

### Product Facts

- Function 50/51
- ANSI/IEEE C37.90-1978
- UL File No. E58048 
- CSA File No. LR61158 

Current sensitive relays are available for single and three phase applications. Voltage controlled overcurrent relays protect generators against fault currents below the full rated value, when the fault produces a voltage drop as in the case of short circuits or grounds. Phase balance relays are available to sense and control unbalanced current flow in three phase systems. Current differential relays operate when the differential between two currents exceeds preset values. Over/under current phase-band relays are also available.

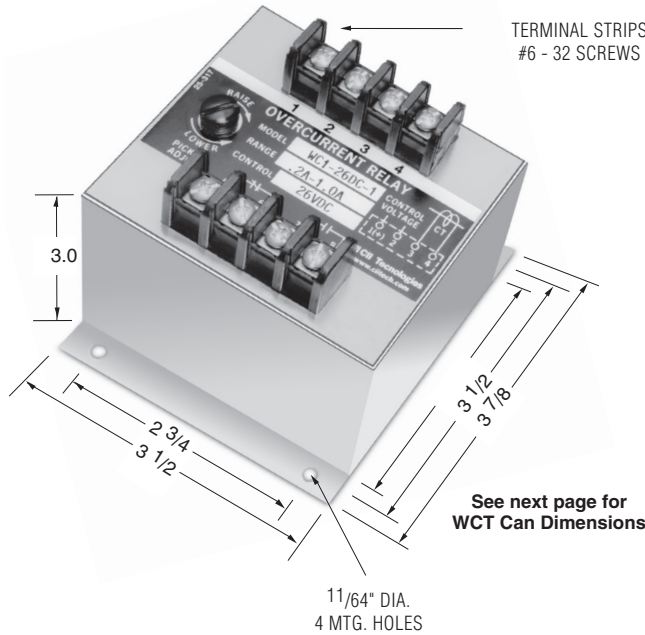

Note: Dimensions in inches. Multiply values by 25.4 for dimensions in mm.

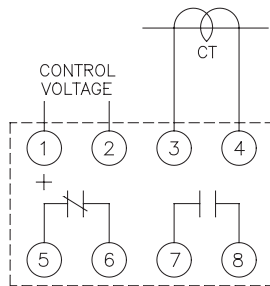

### Product Specifications

- Line Current** — Single Phase, AC current, 50-400 Hz Direct or from CT
- Control Voltage** — See Ordering Information
- Trip Point** — Screwdriver adjustable. Adjustment range in accordance with ordering information.
- Pick-up to Drop-Out Differential** — Approximately 0.1 amp.
- Overcurrent Allowance** — Maximum of 500% for 0.25 seconds
- Surge Withstand Capability** — In compliance with C37.90B ANSI/IEEE
- Operating Temperature** — -40°C to +70°C
- Temperature Drift** — ± .05%
- Burden** — Current input — 1.2 VA, Control voltage — 2.5 VA
- Contact Ratings** — One set, N.O., One set N.C. 5 amp resistive at 120 VAC or 28 VDC

See next page for WCT Can Dimensions

### Notes:

1. Remove black screws for access to the current pick-up and the time delay adjustment.
2. Clockwise rotation of the pick-up adjustment will raise the current trip point.
3. Clockwise rotation of the time delay adjustment, (Type WCT1 only) will increase the time delay.

### Time Delay

**Standard Time Delay (WC1 Series)** — A fixed inverse time delay is incorporated in all overcurrent relays and is represented by the typical curves shown.

**Adjustable Time Delay (WCT1 Series)** — The time delay is field adjustable. The standard time delay can be increased by any value between 0.5 and 20 seconds.

### Ordering Information

Sample Part Number ► **WCT1 -48DC -5 -B**

Type: \_\_\_\_\_  
 WC1 = Per Time Curves  
 WCT1 = Adjustable Time Delay

Control Voltage (± 15%) \_\_\_\_\_  
 26 DC  
 48 DC  
 125 AC  
 120 AC  
 230 AC  
 380 AC  
 460 AC

Trip Adjustment Range \_\_\_\_\_  
 1 = .2 amp - 1 amp  
 5 = 1 amp to 5 amp  
 10 = 2 amp to 10 amp

Other Options \_\_\_\_\_  
 A = Two normally open contacts  
 B = Two normally closed contacts

### Typical Curves (WC1 Series)

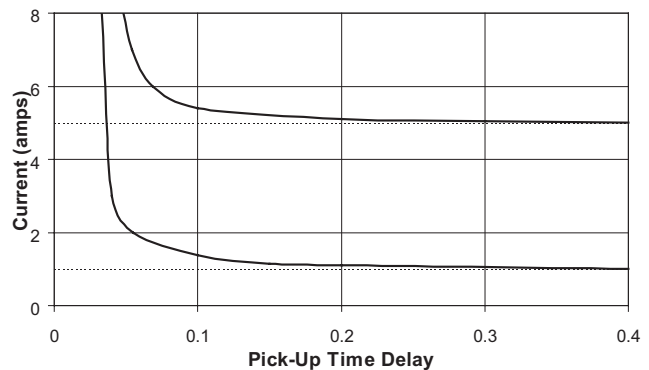



See next page for 3-phase types and consult factory for additional models.



## WC3 & WCT3 Series, Overcurrent

### Product Facts

- Function 50/51
- ANSI/IEEE C37.90-1978
- UL File No. E58048 
- CSA File No. LR61158 

Current sensitive relays are available for single and three phase applications. Voltage controlled overcurrent relays protect generators against fault currents below the full rated value, when the fault produces a voltage drop as in the case of short circuits or grounds. Phase balance relays are available to sense and control unbalanced current flow in three phase systems. Current differential relays operate when the differential between two currents exceeds preset values. Over/under current phase-band relays are also available.

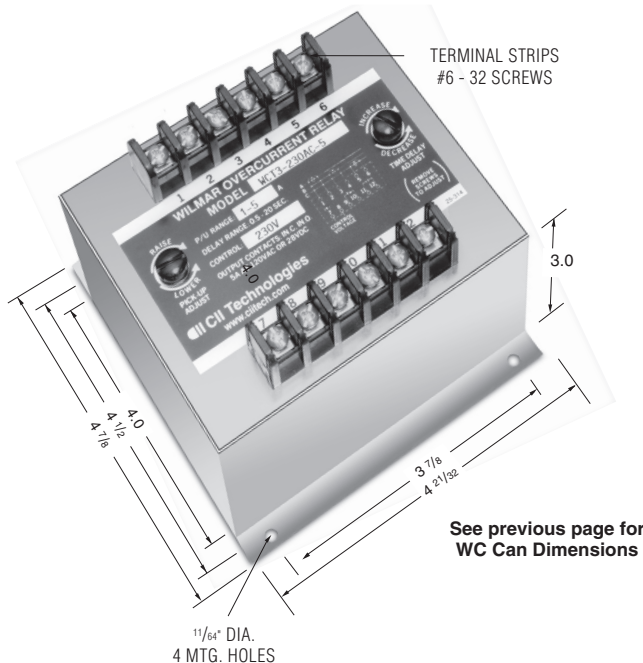

**Note:** Dimensions in inches. Multiply values by 25.4 for dimensions in mm.

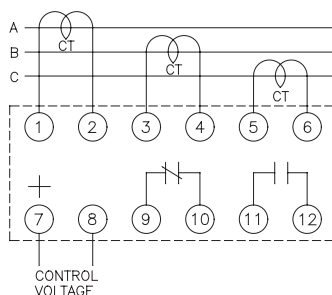

### Time Delay

**Standard Time Delay (WC3 Series)** — A fixed inverse time delay is incorporated in all overcurrent relays and is represented by the typical curves shown.

**Adjustable Time Delay (WCT3 Series)** — The time delay is field adjustable. The standard time delay can be increased by any value between 0.5 and 20 seconds.

### Product Specifications

**Line Current** — Three Phase, AC current, 50-400 Hz Direct or from CT

**Control Voltage** — See Ordering Information

**Trip Point** — Screwdriver adjustable. Adjustment range in accordance with ordering information.

**Pick-Up to Drop-Out Differential** — Approximately 0.1 amp

**Overcurrent Allowance** — Maximum of 500% for 0.25 seconds

**Surge Withstand Capability** — In compliance with the requirements of ANSI/IEEE

**Operating Temperature** — -40°C to +70°C

**Temperature Drift** — ± 0.05%/°C

**Burden** — Current input — 1.2 VA, Control voltage — 2.5 VA

**Contact Ratings** — One set, N.O., One set N.C. 5 amp resistive at 120 VAC or 28VDC

### Notes:

1. Remove black screws for access to the current pick-up and the time delay adjustment.
2. Clockwise rotation of the pick-up adjustment will raise the current trip point.
3. Clockwise rotation of the time delay adjustment, (Type WCT3 only) will increase the time delay.

### Ordering Information

Sample Part Number ►

WCT3 -48DC -5 A

Type:

- WC3 = Per Time Curves
- WCT3 = Adjustable Time Delay

Control Voltage (± 15%)

- 26 DC
- 48 DC
- 125 DC
- 120 AC
- 230 AC
- 380 AC
- 460 AC

Trip Adjustment Range

- 1 = .2 amp - 1 amp
- 5 = 1 amp to 5 amp
- 10 = 2 amp to 10 amp

Other Options

- A = Two normally open contacts
- B = Two normally closed contacts

Typical Curves (WC3 Series)

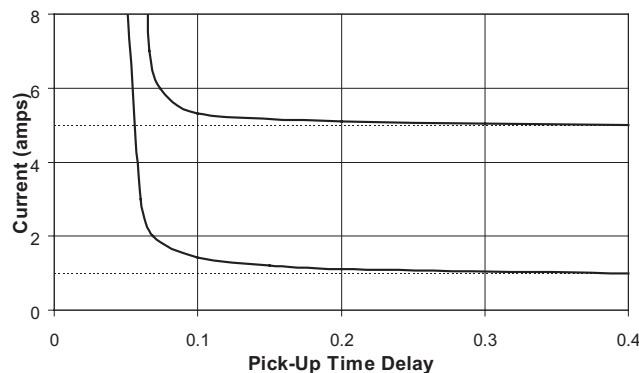

See previous page for 1-phase models and consult factory for additional models.

## WCD Series

### Product Facts

- Function 87
- ANSI/IEEE C37.90-1978

Current Differential Relays are used for the protection of transformers, motors and generators, by comparing the magnitude of the current entering and leaving the protected circuit. On a given phase winding, any difference between the two currents will indicate an internal fault; the relay will sense the vectorial difference between the two currents of the protected section and will initiate a quick disconnection of the unit, to prevent disastrous consequences.

The relay may also be used to protect internal faults on transformers, such as: ground faults, shorted winding, leakage between primary and secondary, etc. It will sense and compare primary vs. secondary currents, once the turns ratio has been taken into consideration.

### Operation

With control voltage applied, the output contacts (shown in the de-energized position) will remain de-energized as long as the difference between the two input currents remains below the pre-set trip value. The contact will transfer to the energized position when the current difference exceeds the trip value.

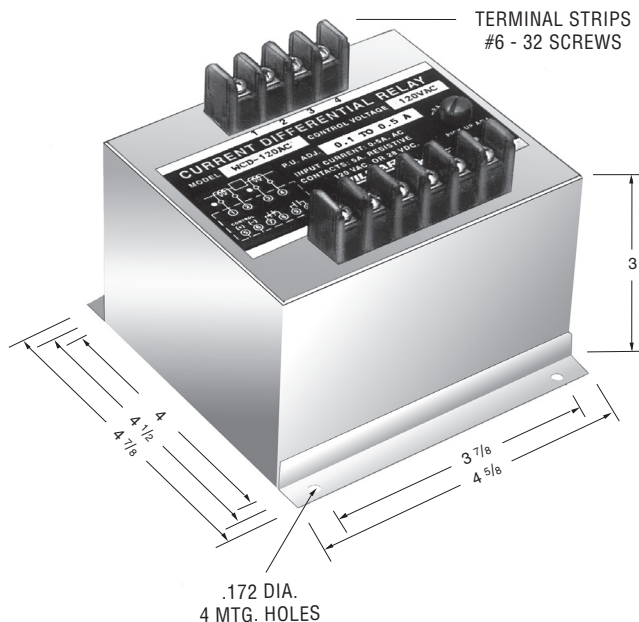

**Note:** Dimensions in inches. Multiply values by 25.4 for dimensions in mm.

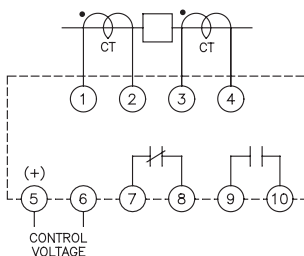

### Ordering Information

**Sample Part Number** ▶ **WCD -230AC -1 -A**

**Type:** WCD - Close Differential

**Control Voltage**

120AC	25DC
208AC	48DC
230AC	125DC
380AC	
416AC	
460AC	
525AC	
575AC	

**Trip Adjustment Range**

- .5 = 0.1 amp to 0.5 amp
- 1 = 0.2 amp to 1 amp
- 2 = 0.4 amp to 2 amp

**Options:**

- A = Two normally open contacts
- B = Two normally closed contacts
- H = Contacts rated 3 amp at 125 VDC
- P = Transient protection is provided in compliance with ANSI/IEEE C37.90-1978

### Product Specifications

- Line Current** —  
 Single Phase, AC current, 50-400 Hz  
 Direct or from CT  
 5 amp continuously  
 20 amp 30 seconds  
 200 amp, 0.10 seconds
- Control Voltage** — See Ordering Information
- Differential Trip Point** —  
 Screwdriver adjustable. See Ordering Information
- Operating Temperature** —  
 -40°C to +75°C
- Burden** —  
 Current input — 2.5 VA max.  
 Control voltage DC — 2 W max.  
 AC — 2 VA max.
- Output Contacts** —  
 One set, N.O., One set N.C.
- Contact Ratings** —  
 5 amp resistive at 120 VAC or 28 VDC



### Notes:

1. Remove black screws for access to the trip adjustments.
2. Clockwise rotation of the adjustment potentiometer will raise the current differential trip point.
3. The output contacts are shown de-energized.

**Consult factory for additional models.**

## 1800 Series

### Product Facts

- Function 25
- ANSI/IEEE C37.90-1978
- UL File No. E58048 
- CSA File No. LR61158 

### Application

These relays are designed for automatic paralleling (synchronizing) of generators. The relays sense the phase angle displacement and the amplitude difference between two voltages and permit paralleling only when both voltages are equal and in phase. A short time delay is provided to assure that the frequencies are essentially the same at the moment of paralleling. The basic series is designed to parallel two or more energized AC generators. The "Dead Bus" type provides paralleling of AC generators to the main bus. They permit electrical connection of an energized generator to an un-energized line (Dead Bus). If the bus is energized, connection of the generator to the bus is permitted only when both are synchronized.

### Notes

- \*Permits paralleling of two generators only when they are "on-line" and their voltages are equal and in phase (synchronized)
- \*\*Normally used to permit paralleling of a generator to a bus when: (a) both line voltages are equal and in phase, or: (b) when the generator is "on-line" and the bus is "dead"
- \*\*\*Permits paralleling of two power lines (buses) when: (a) both line voltages are equal and in phase, or: (b) when either bus is "hot" and the other bus is "dead"

### Output Contact Options —

1. Two Form A. (Add -A to Model Number)
2. Two Form B. (Add -B to Model Number)

Consult factory for additional models.

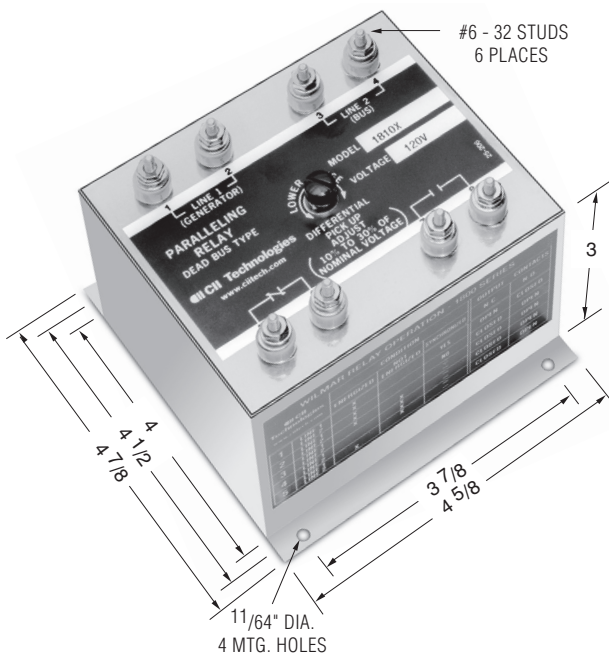

Note: Dimensions in inches. Multiply values by 25.4 for dimensions in mm.

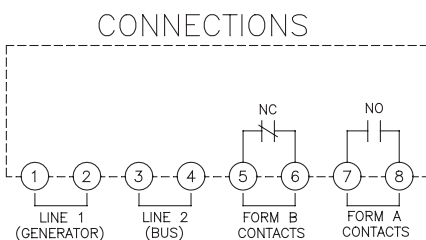

### Product Specifications

**Sensing Voltage** — 120 V, 230 V, 277 V, 380 V, 460 V, 575 V, & 415 V

**Line Frequency** — 50-500 Hz

**Pick-Up Adjustment** — External adjustment for field sensing of 10-30% of nominal input voltage. (Vertical voltage differential of 6 to 18 electrical degrees).

**Time Delay** — Fixed @ 60 milliseconds is provided to assure that the frequencies of both input lines are sufficiently close to permit paralleling within the preset window.

**Output Contacts** — One set N.O., one set N.C. 5 amp resistive at 120 VAC or 28 VDC

### A. 3 Phase, 4 Wire System

- Connect phase "A" of LINE 1 to terminal 1
- Connect phase "A" of LINE 2 to terminal 3
- Connect the neutrals to terminals 2 & 4

### B. 3 Phase, 3 Wire or 1 Phase, 2 Wire System

- Connect phase "A" of LINE 1 to terminal 1
- Connect phase "B" of LINE 1 to terminal 2
- Connect phase "A" of LINE 2 to terminal 3
- Connect phase "B" of LINE 2 to terminal 4



### Selection Guide (Typical Applications)

Sensing Voltage	Series 1800* Generator to Generator	Series 1800DB** Generator to Bus	Series 1800DDB*** Bus to Bus
120 Volts	1810X	1810DBX	1810DDBX
230 Volts	1820X	1820DBX	1820DDBX
380 Volts	1830X	1830DBX	1830DDBX
460 Volts	1840X	1840DBX	1840DDBX
575 Volts	1850X	1850DBX	1850DDBX
415 Volts	1860X	1860DBX	1860DDBX
277 Volts	1870X	1870DBX	1870DDBX

	Condition	Series 1800 Contacts		Series 1800DB Contacts		Series 1800DDB Contacts			
		Energized	Not Energized	N.C.	N.O.	N.C.	N.O.		
1	Line 1	X		Open	Close	Open	Close	Open	Close
	Line 2	X		Yes					
2	Line 1	X		No					
	Line 2	X		No					
3	Line 1	X							
	Line 2		X						
4	Line 1		X						
	Line 2		X						
5	Line 1		X						
	Line 2	X							

## WOF & WUF Series

### Product Facts

- Function 81 O/U
- ANSI/IEEE C37.90-1978
- UL File No. E58048 
- CSA File No. LR61158 

### Application

The output contacts of frequency relays are energized when the frequency exceeds the adjustable set point. Overfrequency and underfrequency relays are available in 50, 60 and 400Hz. Combination over/underfrequency "band pass" relays are also available. These are energized at rated frequency and de-energized during overfrequency or underfrequency conditions. Frequency Differential relays are energized above the preset frequency. The pick-up and drop-out frequency settings are independently adjustable.

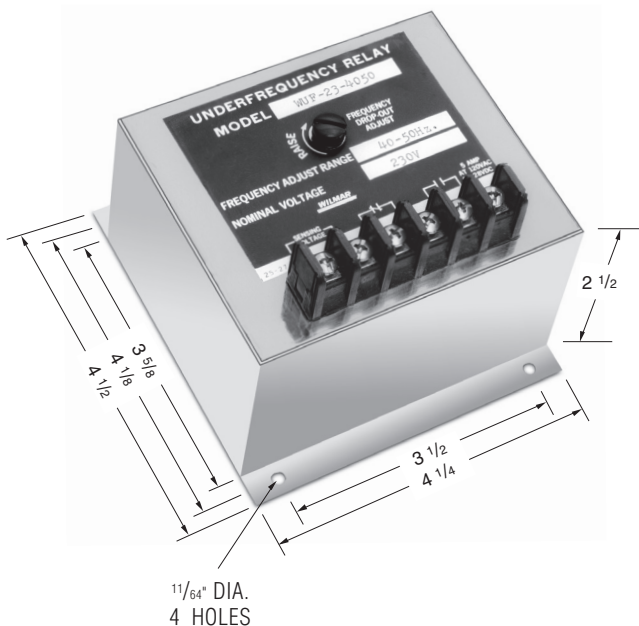
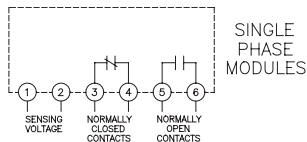

**Note:** Dimensions in inches. Multiply values by 25.4 for dimensions in mm.

### Product Specifications

**Nominal Voltage (±20%)** — 120, 230, 380 and 460 volts

**Nominal Frequencies** — 50, 60 and 400 Hz.

**Trip Point** — Screwdriver adjustable. Adjustment range in accordance with ordering information.

**Operating Temperature** — -20°C to +65°C

**Differential** — The frequency pitch-up to drop-out differential is .5% max

**Voltage Drift** — ±.05% maximum frequency error for input voltage variation of ±10%

**Time Delay** — See Time versus Frequency curves

**Surge Withstand Capability** — In compliance with C37.90B ANSI/IEEE

**Output Contacts** — One set N.O., one set N.C.

**Contact Ratings** — 5 amp resistive at 120 VAC or 28VDC

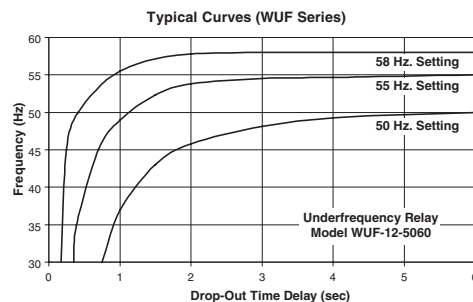
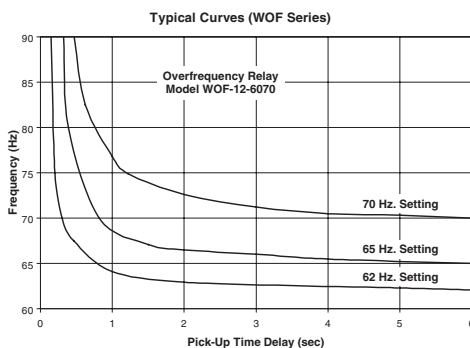

### Ordering Information

Sample Part Number ► **WUF -12 -5060 -T**

**Type:** —  
WUF = Underfrequency  
WOF = Overfrequency

**Input Voltage (VAC)** —  
12 = 120  
23 = 230  
38 = 380  
46 = 460

**Frequency Range** —  
4050 = 40-50 HZ  
5060 = 50-60 HZ  
6070 = 60-70 HZ  
3540 = 350-400 HZ  
4045 = 400-450 HZ (overfrequency only)

**Time Delay Options** —  
blank = Per Time Curve  
T = Adjustable

### Time Delay

**Standard Time Delay** — A minimum, fixed inverse time delay is incorporated in all frequency relays to prevent nuisance tripping and is represented by the typical curves shown above.

**Adjustable Time Delay** — If additional time delay is required, a suffix "T" must be added to the part number. This allows the minimum fixed time delay to be field-adjustable up to 20 seconds.

### Notes:



1. Remove black screws for access to the frequency and the time adjustments.
2. Clockwise rotation of the frequency potentiometer will raise the frequency trip point.
3. Clockwise rotation of the time adjustment, option "T" will increase the time for overfrequency relays and dropout time for underfrequency relays.

Consult factory for additional models.



## WOUF Series, Over/Underfrequency

### Product Facts

- Function 81 O/U
- ANSI/IEEE C37.90-1978
- UL File No. E58048 
- CSA File No. LR61158 

The output contacts of frequency relays are energized when the frequency exceeds the adjustable set point. Overfrequency and underfrequency relays are available in 50, 60 and 400Hz. Combination over/underfrequency “band pass” relays are also available. These are energized at rated frequency and de-energized during overfrequency or underfrequency conditions. Frequency Differential relays are energized above the preset frequency. The pick-up and drop-out frequency settings are independently adjustable.

### Operation

The relay will energize at normal frequency; The normally closed contacts will open and the normally open contacts will close. The relay will drop-out after time delay at overfrequency or underfrequency.

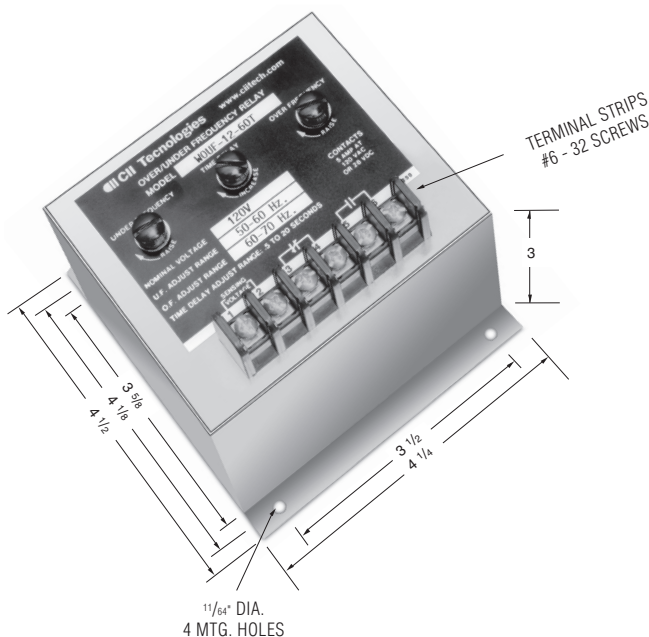

**Note:** Dimensions in inches. Multiply values by 25.4 for dimensions in mm.

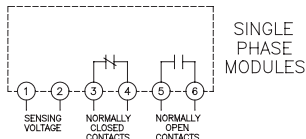

### Product Specifications

**Nominal Voltage (±20%)** — 120, 230, 380 and 460 volts

**Nominal Frequencies** — 50, 60 and 400 Hz.

**Trip Point** — Screwdriver adjustable. Adjustment range in accordance with ordering information.

**Operating Temperature** — -40°C to +65°C

**Differential** — The frequency pick-up to drop-out differential is .5% max

**Voltage Drift** — ± 0.05% maximum frequency error for input voltage variation of ±10%

**Time Delay** — See Time versus Frequency curves

**Surge Withstand Capability** — In compliance with C37-90B ANSI/IEEE

**Output Contacts** — One set N.O., one set N.C.

**Contact Ratings** — 5 amp resistive at 120 VAC or 28 VDC

### Notes:

1. Remove black screws for access to the frequency and the time adjustments.
2. Clockwise rotation of the frequency potentiometer will raise the frequency trip point.
3. Clockwise rotation of the time adjustment, option “T” will increase the drop-out time delay.

### Time Delay

**Standard Time Delay** — A minimum, fixed inverse time delay is incorporated in all frequency relays to prevent nuisance tripping and is represented by the typical curves shown below.

### Adjustable Time Delay

If additional time delay is required, a suffix “T” must be added to the part number. This allows the minimum fixed time delay to be field-adjustable up to 20 seconds.

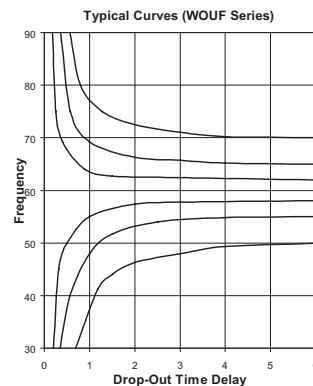

### Ordering Information

**Sample Part Number** ► **WOUF -12 -5060 -T**

**Type:** \_\_\_\_\_  
WOUF = Over/Underfrequency

**Input Voltage (VAC)** \_\_\_\_\_  
12 = 120  
23 = 230  
38 = 380  
46 = 460

**Frequency Range** \_\_\_\_\_  

	<b>UF Adj.</b>	<b>OF Adj.</b>
50 =	40-50 Hz	50-60 Hz
60 =	50-60 Hz	60-70 Hz
400 =	350-400 Hz	400-450 Hz

**Time Delay Options** \_\_\_\_\_  
blank = Per Time Curve  
T = Adjustable

Consult factory for additional models.

## 20-000 Series

### Product Facts

■ Function 81 0



The output contacts of frequency relays are energized when the frequency exceeds the adjustable set point. Overfrequency and underfrequency relays are available in 50, 60 and 400Hz. Combination over/underfrequency “band pass” relays are also available. These are energized at rated frequency and de-energized during overfrequency or underfrequency conditions. Frequency Differential relays are energized between the preset frequencies. The pick-up and drop-out frequency settings are independently adjustable.

### Operation

The normally open contacts close, and the normally closed contacts open, at all frequencies above the set point. The contacts in the connection diagram, are shown in the de-energized position (below the trip set point).

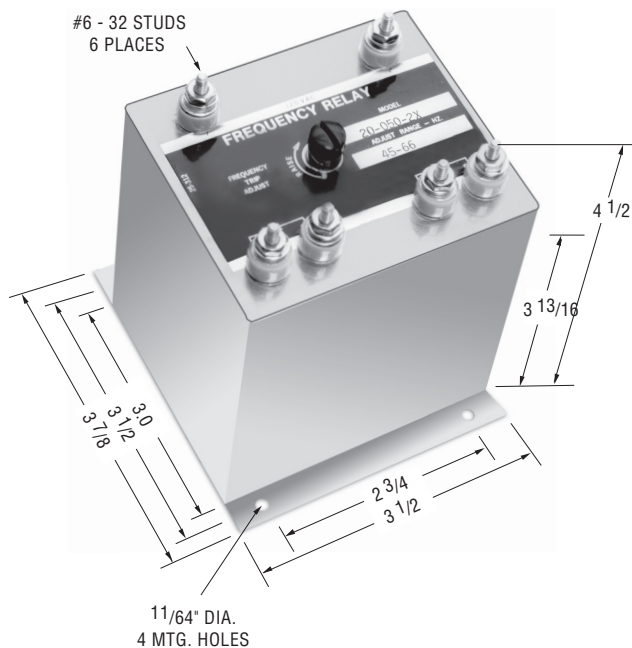

**Note:** Dimensions in inches. Multiply values by 25.4 for dimensions in mm.

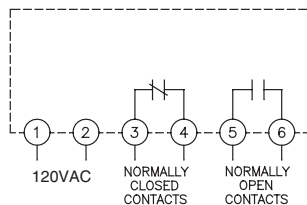

### Product Specifications

- Input Voltage (±10%)** — 120 VAC, Single Phase
- Frequencies Range (adjustable)** — See Ordering Information
- Differential** — Frequency pick-up to drop-out differential is 1% max
- Temperature Range** — -40°C to +85°C
- Temperature Drift** — ± 1% frequency error over temperature range
- Voltage Error** — ± 1% for input voltage of 120 VAC ± 10%
- Contact Ratings** — 5 amp resistive at 120 VAC or 28 VDC
- Output Contacts** — One set N.O., one set N.C.

### Notes:

1. Remove screw for access to trip adjustment.

### Ordering Information

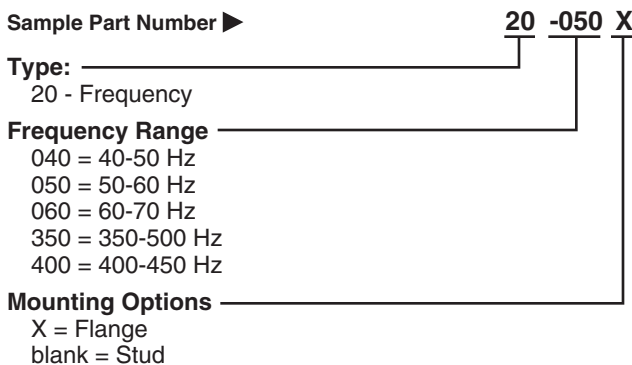

Consult factory for additional models.

### 25-000 Series

**Product Facts**

- Function 81 O/U
- ANSI/IEEE C37.90-1978

The output contacts of frequency relays are energized when the frequency exceeds the adjustable set point. Overfrequency and underfrequency relays are available in 50, 60 and 400Hz. Combination over/underfrequency “band pass” relays are also available. These are energized at rated frequency and de-energized during overfrequency or underfrequency conditions. Frequency Differential relays are energized above the preset frequency. The pick-up and drop-out frequency settings are independently adjustable.

**Operation**

The normally open contacts close, and the normally closed contacts open, at nominal frequency. The contacts are de-energize at underfrequency, overfrequency or no input voltage.

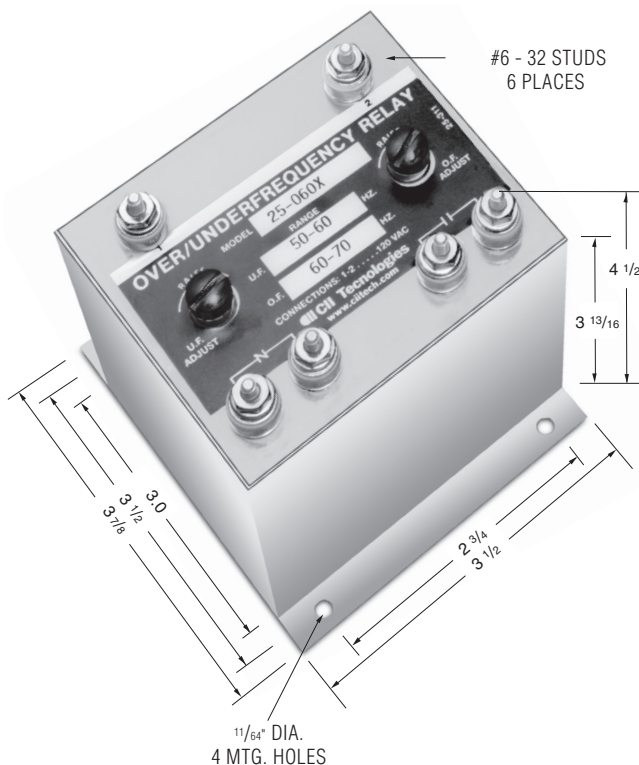

**Product Specifications**

- Input Voltage (±10%)** — 120 VAC
- Frequency Range (adjustable)** — See Ordering Information
- Trip Points** — Screwdriver adjustable
- Temperature Range** — -20°C to +85°C
- Temperature Drift** — ± 1% frequency error over temperature range
- Voltage Drift** — ± 1% frequency error input voltage variation of ± 10%
- Contact Ratings** — 5 Amp resistive at 120 VAC or 28VDC
- Output Contacts** — One set N.O., One set N.C.

**Notes:**

1. The contacts are shown in the de-energized position.
2. Remove screws for access to the underfrequency and overfrequency trip adjustments.
3. Clockwise rotation of the adjustment potentiometer will raise the frequency trip points.

**Note:** Dimensions in inches. Multiply values by 25.4 for dimensions in mm.

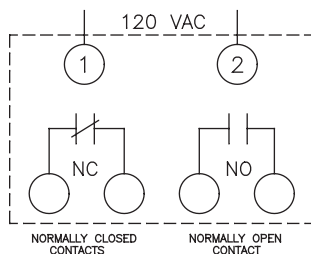

**Ordering Information**

**Sample Part Number** ▶ **25 -050 X**

**Type:** \_\_\_\_\_

25 - Over/Underfrequency

**Frequency Range** \_\_\_\_\_

	<b>Under</b>	<b>Over</b>
050 =	40-50 Hz	50-60 Hz
060 =	50- 60 Hz	60-70Hz
400 =	350- 400 Hz	400-450Hz



**Mounting Options** \_\_\_\_\_

X = Flange  
blank = Stud

Consult factory for additional models.

## 20-050-19 Series (Voltage/Frequency)

### Product Facts

- Function 27/81
- ANSI/IEEE C37.90-1978
- UL file No. E58048 
- CSA file No. LR61158 

The output contacts of frequency relays are energized when the frequency exceeds the adjustable set point. Overfrequency and underfrequency relays are available in 50, 60, and 400Hz. Combination over/underfrequency “band pass” relays are also available. These are energized at rated frequency and de-energized during overfrequency or underfrequency conditions. Frequency Differential relays are energized above the preset frequency. The pick-up and drop-out frequency settings are independently adjustable.

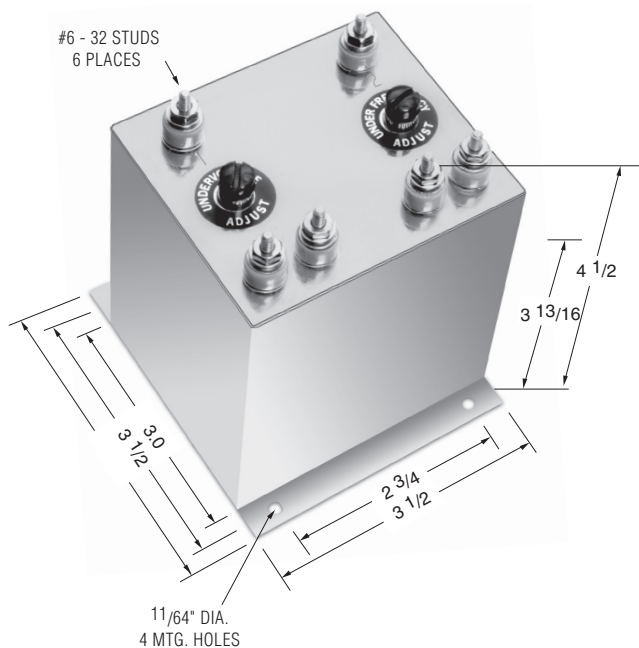

**Note:** Dimensions in inches. Multiply values by 25.4 for dimensions in mm.

### Product Specifications

- Nominal Voltage ( $\pm 20\%$ )** — 120 VAC, Single Phase
- Nominal Frequency** — 60 Hz.
- Voltage Adjustment Range (PU)** — 85 to 120 VAC
- Frequency Adjustment Range (PU)** — 45 to 60 Hz
- Output Contacts** — One set N.O., one set N.C.
- Contact Ratings** — 5 amp resistive at 120 VAC or 28 VDC

### Notes:

1. Remove black screws for access to the voltage and frequency and the time adjustments.
2. Clockwise rotation of the voltage adjustment potentiometer will raise the voltage trip point.
3. Clockwise rotation of the frequency adjustment will raise the frequency time point.

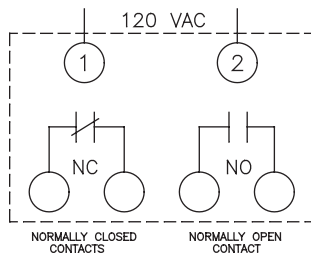

### Ordering Information

Sample Part Number **20-050-19X**

Type: \_\_\_\_\_  
 20-050-19 = Voltage/Frequency

### Mounting Options

Blank = stud  
 X = Flange

### Options:

P = Surge Suppression

Consult factory for additional models.



## WGD Series — Floating Ground

### Product Facts

- ANSI/IEEE C37.90-1978
- UL file No. E58048
- CSA file No. LR61158



Ground Fault Detectors are used to sense leakage current to ground in power transformers and generators. They are available for both AC and DC systems. Some generator systems provide auxiliary power outlets for small equipment. TE Connectivity GFD's eliminate personnel risk of accessing these outlets if a ground fault exists. Diesel locomotives and railroad line signal boxes also use GFD's for operational control purposes. The GFD monitors both positive and negative grounds for fault currents and can trigger either notification or system shut-down if these are detected. GFD's are available for both grounded and ungrounded systems.

### Operation

When the resistance between any phase to ground falls below the set point the relay will energize; The normally closed contacts will open, the normally open contacts will close.

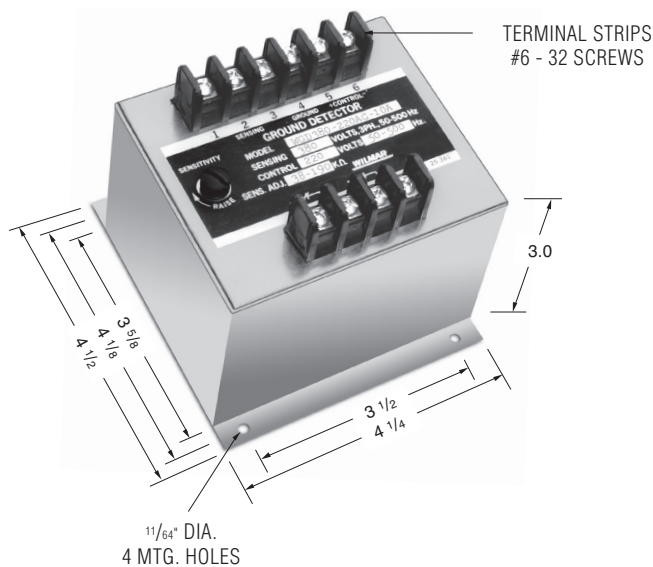

**Note:** Dimensions in inches. Multiply values by 25.4 for dimensions in mm.

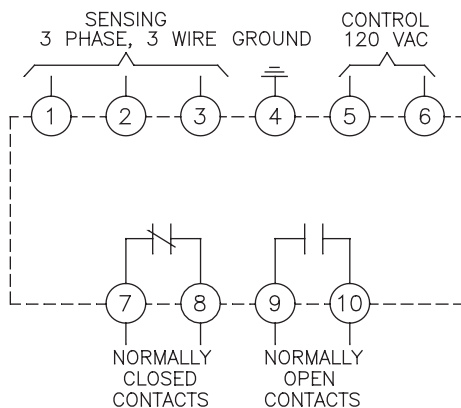

### Ordering Information

Sample Part Number ►

WGD-

Type:	Volts L-L	Trip Point Adj. Phase to Ground
115-120AC	115	11-55KΩ
120-120AC	120	12-60KΩ
200-120AC	200	20-100KΩ
208-120AC	208	21-105KΩ
220-120AC	220	22-110KΩ
230-120AC	230	23-115KΩ
240-120AC	240	23-115KΩ
380-120AC	380	38-190KΩ
400-120AC	400	40-200KΩ
416-120AC	416	42-210KΩ
440-120AC	440	44-220KΩ
460-120AC	460	46-230KΩ
480-120AC	480	48-240KΩ
525-120AC	525	52-260KΩ
575-120AC	575	57-285KΩ
600-120AC	600	60-300KΩ

### Product Specifications

**Sensing Voltage (±10%)** — 3 phase, 3-wire. See Ordering Information.

**Control Voltage** — 120 Volts AC

**Contacts Trip Points (sensitivity)** — Screwdriver adjustable. See Ordering Information.

**Pick-up Time Delay** — 1.5 seconds approximately

**Contact Ratings** — 5 amp resistive at 120 VAC or 28 VDC

**Operating Temperature** — -40°C to +65°C

**Temperature Effects** — ± 1% over temperature range

**Power Consumption** — Sensing: —2 mA/Phase Approx., Control — 2VA at 120VAC

**Surge Withstand Capability** — In accordance with the requirements of ANSI/IEEE

### Notes:

1. Remove screw for access to the pick-up adjustment potentiometer.
2. Clockwise rotation of the adjustment potentiometer will raise the relay sensitivity.

11

Protective Relays

## WC1G Series — Grounded

Ground Fault Detectors are designed to provide very sensitive Ground-Current protection for motor, equipment and personnel from damage or electrical shock. In a ground system, the leakage current is monitored through a toroidal or doughnut current transformer placed around the supply conductors to a motor, transformer, equipment or outlets. Since the sums of the current in a system add to zero, the relay is responsive only to ground-fault current.

### Operation

The output contacts are shown in de-energized position. They will change state when these conditions are met:

1. Control voltage is applied.
2. Leakage current exceed the trip setting.

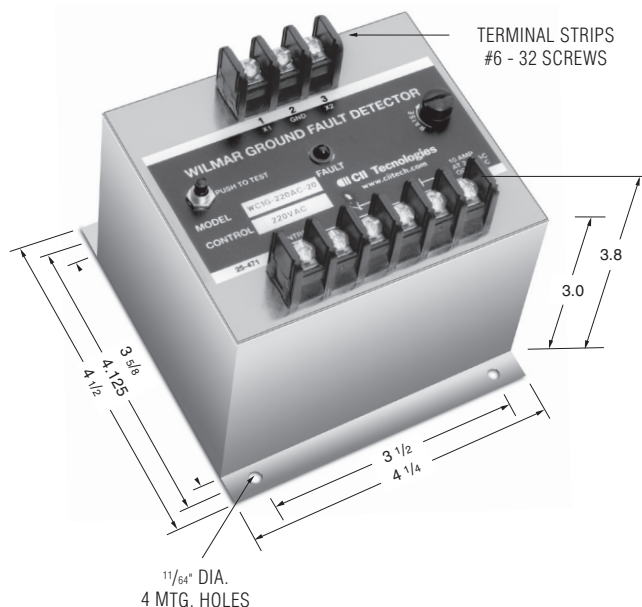

### Product Specifications

**CT Window Diameter** — 1.7 inches (std) or can be specified by customer

**Leakage Current Range** — 10 to 60 mA

**Control Voltage** — See Ordering Information

**Output Contacts** — One set N.C., one set N.O.

**Operating Temperature** — 40°C to +65°C

**Contact Ratings** — 10 amp resistive at 250 Vac, 8 amp. resistive @ 30 Vdc

### Notes:

1. Remove screw for access to the pick-up adjustment potentiometer.
2. Clockwise rotation of the adjustment potentiometer will raise the relay sensitivity.

**Note:** Dimensions in inches. Multiply values by 25.4 for dimensions in mm.

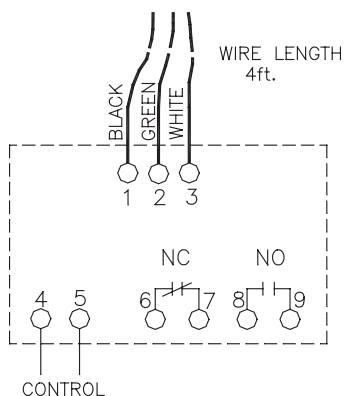

Current Transformer

### Ordering Information

Sample Part Number ► **WC1G-120AC**

Model: WC1G-

Control Voltage

- 120AC
- 220AC
- 230AC
- 380AC
- 400AC
- 460AC
- 480AC
- 575AC

**Additional Relays**

**OVERVOLTAGE RELAYS**

**AC, SINGLE PHASE, 50-400 HZ, SPECIALS**

300X	120VAC
300HX	120VAC, Similar to 300X, with 125VDC 3A Contacts
300S-1X	440VAC, 370-480V Range, Navy High Shock
300-2X	120VAC, Set at 132V, .010 Sec. Time Delay
300S-2X	120VAC, Navy High Shock
300-3X	190VAC, 180-280V Range
300-4X	190VAC, P.U. 264V, D.O. 261V
300-5X	240VAC, 230-360V Range
300-5KX	240VAC, Similar to 300-5X, except 1-10KHz
300-6X	230VAC, 230-300V Range
300-7X	450VAC, 375-475V Range
300-8X	120VAC, P.U. 130V, D.O. 125V
300-9X	120VAC, P.U. 132V, D.O. 126V
300-10X	120VAC, 99-132V Range
300-10HX	120VAC, Sim. to 300-10X, 125VDC 3A Contacts
300-11X	120VAC, 0.5 Sec. Time Delay
300-12X	480VAC, 480-600V Range
300-13X	120VAC, 2 N.O. Contacts
300-14X	95VAC, 95-120V Range
300-17X	120VAC, Similar to 300X with Spike Suppression
300-18X	120VAC, Differential, 2V Max.
300-20X	10VAC, 8-12V Range, 120V Transient, 120VAC Ctrl.
300-21X	120VAC, 1.5-2.0 Sec. Time Delay
300-24X	277VAC, 140-320VAC Range
300-25X	24VAC, 24-30VAC Range
300-26X	120VAC, 90-150V Range
300-27X	120VAC, 105-135VAC Range
300-28X	10VAC, 8-12VAC, 220VAC Transient, 120VAC Ctrl.
300-29X	120VAC, 150-180V Range
300-30X	120VAC, 375V Max., 24VDC Control
300-32X	120VAC, 135-180V Range, 1.5 Sec. Time Delay
300-33X	115/230VAC, DPDT Contacts 230VAC 1A
300-34X	100VAC, 1.5-2.0 Sec. T.D., 100-120V Range
300-35X	480VAC, 1.5-2.0 Sec. T.D., 480-600V Range
300-36X	138VAC, 138-172V Range
300-37X	350VAC, 350-450V Range, 2.0 Sec. T.D., Supp.
300-38X	120VAC, 99-132V Range, 125VDC 1A Contacts
300-39X	120VAC, 120-150V Range, 0.3-3.0 Adj. T.D.
300-40X	230VAC, 220-300V Range, 2.0 Sec. T.D.
300-41X	120VAC, 120-165V Range, 1.5 Sec. T.D., Supp.
300-42X	120VAC, Similar to 300-39X, but 2 N.O. Contacts
300-43X	120/240VAC, 140-180V Range, Phase Protection
300-44X	277VAC, 277-350V Range
300-45X	30/60VAC, 277V Continuous, 115VAC Control
300-46X	67VAC, 67-120V Range
300-47X	360VAC, 10-64V Range, 0.75-7.5 Sec. T.D.
300-48X	10VAC, 8-21V, 220VAC Transient, 125VDC Ctrl.
300-49X	120VAC, Similar to WOV-1-120, but 0.2 Sec. T.D.
300-50X	120/240VAC, Highest of 2, 0.5-10 Sec. T.D.
300-51X	

30/60VAC, 400V Max. Contin., 120V 60Hz Ctrl.	
300-52X	208VAC, 208-291V, 24VDC Ctrl., 1 N.O. Contact
300-53X	200-480VAC, 200-240V Range
300DC-1X	28VDC, Set at 30V, Curve 1 MIL-STD-704

**AC, SINGLE PHASE, 400 HZ**

302X	120VAC
302-SX	120VAC, A.E.I. Special
302-1X	120VAC, 0.3 Sec. T.D.
302-2X	120VAC, 125-175V Range
302-3X	120VAC, 125-150V Range with T.D.
302-4X	120VAC, 125-150V Range, 0.3 Sec. T.D.

**AC, THREE PHASE, 50-400 HZ, SPECIALS**

301X	120/208VAC4W
301-SX	120/208VAC, 4W, Similar to WOV-3-208 with hi-shock
301-HX	120/208VAC, 4W, 125VDC 3A Contacts
301-1X	240VAC, 4W, 240-330V Range
301-2X	220/380VAC, 4W
301-3X	254/440VAC, 4W, 440-605V Range
301-3HX	277/480VAC, 4W, 125VDC 3A Contacts
301-4X	127/220VAC, 4W, 220-275V Range
301-4HX	120/208VAC, 4W, 125VDC 3A Contacts
301-5X	380VAC, 4W, 370-460V Range
301-6X	380VAC, 4W, 375-528V Range
301-7X	120/208VAC, 4W, 0.022 Sec. T.D.
301-8X	120VAC, 3W, 120-150VAC
301-9X	240VAC, 3W, 240-300V Range
301-11X	120/208VAC, Similar to 301-7X
301-12X	440VAC, 3W
301-13SX	120/208VAC, 4W, Hi-Shock, T.D., Solar
301-15X	120/208VAC, 4W, 140-180V Range
301-16X	254/440VAC, 4W, Sim to 301-3, but 3 XFMS
301-17SX	120VAC, 3W, Sim to 301-13SX except 120V
301-18X	277/480VAC, 4W, 3 independent adjustments
301-19SX	94VAC, 3W, Similar to 301-17SX
301-20SX	86/150VAC, 4W, 90-120V Range, T.D., Solar
301-21X	460VAC, 3W, 125VDC Contacts
301-22X	277/480VAC, 4W, 323-425V Range (L-N)
301-23X	380VAC, 3 or 4W, 0.022 Sec. T.D.
301-25X	120/208V, 4W, 2-3 Sec. T.D.
301-26X	416VAC, 3 or 4W, 415-520V Range
301-27X	277/480VAC, 4W, 2-3 Sec. T.D.
301-28X	20.8VAC, 3W, 20-25V Range
301-29X	480VAC, 3 or 4W, Sim. to 301-3X with spike supp.
301-30SX	100VAC, 3W, 100-125V Range, hi-shock
301-31X	208-240, 3W, 200-280V Range, 45-65 Hz.
301-32X	400VAC, 3W, 400-500V Range
301-34X	208VAC, 3W, Set 240V, Withstand 600V contin.
301-35X	120VAC, 3W, 3-5 Sec. T.D.
301-37X	120VAC, 3W, Sim. to 301-8X with spike suppression
301-39X	138/240VAC, 3 or 4W, 2 Sec. T.D.
301-40X	120/208VAC, 4W, Highest of 3, Solar
301-41SX	450VAC, 3W, Navy Hi-Shock, 75VDC 3A Contacts
301-42X	120VAC, 3W, Highest of 3, 120-150V Range
301-45X	120/208VAC, 4W, Highest of 3, Adj. T.D.
301-46X	104VAC, 3W, Similar to WOV-3-104



## Additional Relays (Continued)

301-47X	69/120VAC, 4W, 69-90V Range, 120V (L-N) Contin.	360DC-1X	405VDC, 400-470V Range, Spike Suppression
301-48X	380VAC, 3 or 4W, 380-500V Range	360DC-2X	475VDC, 475-550V Range
301-49X	250VAC, Withstand 520VAC Continuous	360DC-3X	550VDC, 550-600V Range
301-50X	180VAC, 3W, Similar to WOV-3-180	360DC-4X	350VDC, 350-440V Range, Bi-Directional
301-51X	120VAC, 3W, Supp, 10CFR Class1E (Nuclear)	360DC-4HX	350VDC, 350-440V Range, Bi-Directional
301-52X	95VAC, 3W, 95-120V (L-L) Range	370DCX	620VDC, 600-670V Range
301-53X	115/200VAC, Similar to WOV-3-200, 1.0 Sec T.D.	370DC-2X	550VDC, 550-650V Range
		370DC-1X	610VDC, 600-800V Range, 120VAC Control
		370DC-3X	610VDC, 800-1000VDC Range
		370DC-5X	960VDC, 900-1000VDC Range
	<b>AC, THREE PHASE, 400 HZ</b>		<b>AC, SINGLE PHASE, 50/60 HZ, SPECIALS</b>
303X	120/208VAC, 4W	400X	120VAC
303-1X	115/200VAC, 4W, Highest of 3, T.D., MIL-E-7894	400HX	120VAC, Sim. to 400X with 125VDC 3A Contacts
303-1SX	115/200VAC, 3W, High Shock	400SX	120VAC, Hi-Shock, 10A Contacts
303-2X	120/208VAC, 4W, High of 3, T.D., MIL-E-7894	400-1X	120VAC, 55-72V Range
303-3X	120/208VAC, Highest of 3, T.D.	400-1HX	120VAC, Sim. to 400-1X, 125VDC 3A Contacts
303-4X	120VAC, 3W, 120-160V Range	400-S-1	450VAC, 240-350V Range, Hi-Shock, T.D.
303-8X	254/440VAC, 4W	400-2X	120VAC, 0.017 Sec. T.D.
303-9X	240/416VAC, 4W	400-S-2	440VAC, 280-420V Range, Hi-Shock, T.D.
303-10X	120/208VAC, 4W, 168V P.U., Kato	400-3X	120VAC, 4.8 Sec. T.D., 80-115V Range
303-12X	120/208VAC, 4W, Fast Operating	400-S-3	440VAC, 280-420V Range, Hi-Shock, T.D.
303-13X	120/208VAC, 4W, 0 deg. C to 90 deg. C	400-4X	240VAC, 170-240V Range
303-15X	120/208VAC, Sim. to 303-13X with Latching Circuit	400-S-4	440VAC, Sim. to 400-2SX, 2-3 Sec. T.D., D.O. 160V
303-16X	120/208VAC, 303X with conformal coating	400-5X	450VAC, 320-450V Range
	<b>DC</b>	400-5SX	450VAC, 70-100% Range, Hi-Shock, 10A Contacts
310DCX	28VDC, 28-36V Range	400-6X	120VAC, 90-123V Range
310DC-HX	28VDC, 28-36V Range, 125VDC 2A Contacts	400-7X	277VAC, 190-290V Range
310DC-SX	28VDC, 28-36V Range, 2A Contacts, High Shock	400-8X	120VAC, 55-80V Range
310DC-2X	28VDC, 28-36V Range, T.D., MIL-E-7894 Fig. 2	400-8SX	120VAC, 50-70% Range, Hi-Shock
310DC-3X	28VDC, 35-46V Range, T.D., MIL-E-7894	400-9X	480VAC, 320-480V Range
310DC-4X	28VDC, Set 31V, 2 Sec; 40V, 0.2 Sec.	400-10X	120VAC, 1.0 Sec. T.D. with power loss
311DCX	12VDC, 12-16V Range	400-11X	480VAC, 1.0 Sec. T.D., 320-480V Range
311DC-1X	12VDC, 12-16V Range, 1V Differential	400-12X	120VAC, Similar to 400-10X except 1 N.O. & 1 N.C.
320DCX	60VDC, 60-85V Range	400-13X	120VAC, 14-30V Range
320DC-HX	60VDC, 60-85V Range, 125VDC 2A Contacts	400-14X	67VAC, 30-67V Range, Suppression
320DC-1X	35-60VDC, Spike Suppression	400-16X	120VAC, 0.6 Sec. T.D., 50-420 Hz
320DC-2X	55-80VDC, Spike Suppression	400-17X	120VAC, Similar to 400-2 with seismic
320DC-4X	48VDC, 48-70V Range	400-19X	120VAC, 125VDC 2A Contacts, Suppression
320DC-5X	20-70VDC, 120VAC Control	400-20X	208VAC, 24-48V Range
330DCX	120VDC, 120-160V Range	400-21X	120VAC, 94.8-102V Range, 6 +/-2 Sec. T.D.
330DC-HX	120VDC, 120-160V Range, 125VDC 2A Contacts	400-23X	480VAC, 320-480V Range, 2.0 Sec. T.D.
330DC-1X	120VDC, 110-150V Range	400-24X	120VAC, 2.0 Sec. T.D.
330DC-2X	120VDC, 150-190V Range	400-25X	240/480VAC, 3-30Sec. T.D., Latching
340DCX	240VDC, 240-300V Range	400-26X	480VAC, 160-200V Range
340DC-HX	240VDC, 240-300V Range, 125VDC 2A Contacts	400-27X	460VAC, 250-350V Range, 0.3 Sec. T.D., Set to 76V
340DC-1SX	200VDC, 240-300V Range, Non-Mag., High Shock	400-28X	0.5VAC, 0.5-1.0V Range, 115VAC Control
350DCX	305VDC, 280-400V Range	400-29X	120VAC, 0.15 Sec. T.D., 10A Contacts
350DC-HX	305VDC, 280-400V Range, 125VDC 2A Contacts	400-30X	24VAC, 18-24VAC Adjustable
350DC-1SX	250VDC, 280-400V Range, Hi-Shock, 120VAC Control	400-31X	120VAC, 105-135V Range
360DCX	405VDC, 400-470V Range	400-32X	120VAC, 1 Ph. T.D. 0-10 Sec.
360DC-HX	405VDC, 400-470V Range, 125VDC 2A Contacts	400-33X	480VAC, 1 Ph. T.D., 0-10Sec.
		400-34X	120VAC, 55-72V Range, 2 N.O. Contacts
		400-35X	120VAC, Similar to 400X, but 2 N.C. Contacts

**Additional Relays** (Continued)

400-36X	120VAC, Similar to 400-24X, 1 N.O., 1 N.C. Contact
400-37X	120VAC, Similar to 400X, with Suppression
400-38X	120VAC, 85-120V, 1-20 Sec. T.D., Instant. at 50V
400-38PX	120VAC, Similar to 400-38X with Spike Protection
400-39X	120VAC, 1.0 Sec. T.D., Transient Protection
400-40X	120VAC, 0.083 Sec. T.D.
400-41X	120VAC, Similar to 400X with 2 N.O. Contacts
400-43X	240VAC, 120-240V Range
400-44X	208VAC, 150-210V Range
400-47X	380VAC, Fast Operating, 220VAC 5A Contacts
400-49X	120VAC, 55-80V Range, 125VDC Contacts
400-50X	480VAC, 320-480V Range, 125VDC 1A Contacts
400-51X	120VAC, Sim. to 400-38X with 1-30 Sec. T.D.
400-52X	120VAC, 55-80V Range, 125VDC 2A Contacts
400-53SX	450VAC, 110-300V Range, 120V Control
400-54X	120VAC, Sim. to 400-13X with 1.0 Sec. T.D.
400-55X	208VAC, 125-208V, 24VDC Ctrl., 1 N.O. Contact
400-56X	208VAC, 24-48V Range, 2 N.O. Contacts
400-57X	120VAC, 25 Hz, 84-120V, 125VDC 3A Contacts
400-58X	277VAC, 194-277V Range, 0.020 Sec. T.D.
400-59X	139VAC, 97-159V Range
400-60X	240VAC, 84-120V Range
400-61PX	120VAC, Similar to WUV-1-120P
400-62X	120VAC, 30-42V Range, 125VDC Contacts
400-63X	120VAC, 30-42V Range, 120VAC Contacts

**AC, SINGLE PHASE, 400 HZ**

402X	120VAC
402-SX	120VAC, Hi-Shock, NSN 5945-00-258-6662
402-1X	240VAC, 170-240V Range
402-1SX	240VAC, High Shock
402-2X	120VAC, 90-120V Range, 0.3 Sec. T.D., Set to 96V
402-3X	120VAC, Similar to 402-2X with 10A Contact
402-4X	120VAC, Similar to 402-2X with 0.15 Sec. T.D.

**AC & DC, SINGLE PHASE, CLOSE DIFFERENTIAL**

D100-10X	120VAC, 50-500Hz, -40 to +75 deg. C
D100-13X	450VAC, D.O. 60-100%, P.U. 66-100%
D100-15X	120VAC, 50-500Hz, 125VDC, 1 Amp Contacts
D100-16X	208VAC, 50-500Hz, 125VDC, 1 Amp Contacts
D100-17X	120VAC, 50-500Hz, 450VAC Input Capacitor, GE
D100-18X	120VAC, Hi-Shock, D.O. 72-84, P.U. 102-114 Range
D100-19X	120VAC, Hi-Shock, D.O. 80-120, P.U. 80-120 Range
D100-20X	150VAC, 105-150V Range
D100DCX	60 VDC, 48-55VDC Range, 1.5 Sec. T.D.
D100DC-15X	120VDC, 80-120VDC Adjust, 0.4V Differential
D100DC-16X	60VDC, 40-60VDC Adjust, 0.2V Differential
D100DC-18X	40VDC, 20-40VDC Adjust, 120VAC Control
D100DC-19X	140VDC, 100-140VDC, 0.4V Differential
D100DC-22HX	120VDC, 80-120VDC Range, 120VDC Contacts
D100DC-23X	260VDC, 195-260VDC Range

D100DC-35X	30-40VDC Range, Plug-in, NSN 5945-00-650-8613
D100DC-36X	48VDC, Adjustable 38-48VDC
D100DC-37X	75VDC, 50-80VDC Range, 0.5A, 74VDC Contacts
D100DC-38X	270VDC, 190-270VDC Range, Similar to D100DC-23
D100DC-39X	28VDC, Adjustable 15-30VDC
D100DC-40X	28VDC, Approx. 2.0 Sec T.D.

**AC, THREE PHASE, 50/60 HZ, SPECIALS**

401X	120/208VAC, 4W, 85-120V Range
401-HX	120/208VAC, 4W, 125VDC 3A Contacts
401-1X	240VAC, 4W, 182-244V Range (L-L)
401-2X	480VAC, 4W, 360-485V Range (L-L)
401-2HX	480VAC, 3 or 4W, 125VDC 3A Contacts
401-3X	220VAC, 3W, 160-200V Range (L-L)
401-4X	380VAC, 4W, 150-220V Range (L-N)
401-5X	120VAC, 4W, 90-120V Range (L-L)
401-6X	120VAC, 3W, 85-120V Range (L-L)
401-7X	480VAC, 4W, 332-407V Range (L-L)
401-8X	100VAC, 3W, 70-100V Range (L-L)
401-9X	120/208VAC, 4W, Fast Operating
401-9HX	120/208VAC, 4W, 0.02S T.D., 125VDC 3A Cont.
401-10X	480VAC, 3W, 360-485V Range
401-10HX	480VAC, 3W, 125VDC 3A Contacts
401-11X	240VAC, 3W, 180-240V Range
401-11HX	240VAC, 3W, 125VDC 3A Contacts
401-12X	120/208VAC, 4W, 1.0 Sec. T.D.
401-12HX	120/208VAC, 4W, 1.0 Sec. T.D., 125VDC 3A Contacts
401-13X	380VAC, 3W, 1.0 Sec. T.D.
401-14X	480VAC, 4W, 0.5 Sec. T.D.
401-15X	120/208VAC, Sim. to 401X with 6" leads and socket
401-16X	380VAC, Sim. to 401-4X with 6" leads and socket
401-17SX	120/208VAC, 4W, 10 Sec. T.D., Solar
401-18X	480VAC, 3W, 2.0 Sec. T.D., 90% P.U., 70% D.O.
401-19X	120/208VAC, Sim. to 401X with 2KV Diodes, Supp.
401-20X	69/120VAC, 4W, 25-35V Range, 4KV Diodes, Supp.
401-21X	120/208VAC, 4W, 85-120V Range, 0.05 Sec. T.D.
401-22X	480VAC, 3 or 4W, 5.0 Sec. T.D.
401-23X	120VAC, 3W, 0.05 Sec. T.D.
401-24X	120VAC, 3W, 2 N.C. Contacts
401-25SX	120VAC, 3W, 10Sec. T.D., Solar
401-26X	67/115VAC, 4W, Suppression
401-28X	120/208VAC, 4W, 60-100V Range, Set at 90V
401-29X	120VAC, 4W, 90-120V Range, 1.0 Sec. T.D.
401-29HX	69/120VAC, 4W, 1.0 Sec. T.D., 125VDC 3A Contacts
401-30X	480VAC, 3W, 360-480V Range, 2.0 Sec. T.D. 125VDC 3A Contacts
401-31SX	94VAC, 3W, 10 Sec. T.D., Solar
401-33X	480VAC, 4W, 139-231V Range (L-N)
401-34X	120/208VAC, 4W, 2-3 Sec. T.D.
401-35X	208VAC, 3W, 0.008 Sec. T.D., 28VDC Control
401-36X	480VAC, 3W, 0.008 Sec. T.D., 28VDC Control





## Additional Relays (Continued)

401-37X	120VAC, 3W, 5.0 Sec. T.D.
401-38X	380VAC, 3W, 0.05 Sec. T.D.
401-39X	480VAC, 4W, 250-550V Range (L-L)
401-41X	240/416VAC, 4W, 312-416V Range (L-L)
401-41HX	230/400VAC, 4W, 125VDC 3A Contacts
401-42X	120/208VAC, 4W, 5.0 Sec. T.D.
401-43SX	480VAC, Sim. to 403-7SX except 60 Hz.
401-44X	139/240VAC, 4W, 2.0 Sec. T.D.
401-45X	120VAC, 3W, 85-120V Range (L-L), 125VDC Contacts
401-46X	480VAC, Similar to 401-2X with Suppression
401-47X	380VAC, 3W, 2.0 Sec. T.D.
401-48X	208VAC, 3W, 145-208V Range
401-49X	20.8VAC, 3W, 15.5-20.8V Range
401-50X	120VAC, 3W, 0-10 Sec. T.D.
401-51SX	90/156 VAC, 4W, Similar to 401-17SX
401-52X	480VAC, 3W, Sim. to 401-10X
401-53X	120/208VAC, 4W, 1 N.O., 1 N.C.
401-54X	400VAC, 3W, 300-400V Range
401-55X	600VAC, 3W, 480-600V Range
401-58X	120/208VAC, Sim. to 401X except 2 N.C. Contacts
401-59X	220-380VAC, Dual Voltage 220V or 380V
401-60X	480VAC, 1 N.O., 1 N.C. Contact, 2-3 Sec. T.D.
401-61X	120VAC, 3W, 85-120V Range (L-L), 1.0 Sec. T.D.
401-62X	380VAC, 3W, 220VAC 5A Contacts
401-63X	120VAC, 3W, Sim. to 401-6X with Suppression
401-67X	120/208VAC, 4W, 1.0 Sec. T.D., -55F to +150F
401-68X	120VAC, 3W, 85-120V Range, 2-3 Sec. T.D.
401-69X	120/208VAC, 4W, 85-120V Range, Lowest of 3
401-70X	133/230VAC, 4W, 99-133V Range, Lowest of 3
401-71X	220/380VAC, 4W, 154-220V Range, Lowest of 3
401-72X	266/460VAC, 4W, 186-266V Range, Lowest of 3
401-74X	66/115VAC, 4W, 65-75% Adj., Supp., 125VDC Cont.
401-75X	115/200VAC, 3W, 65-75% Adj., Suppression
401-76SX	450VAC, 3W, 382-450V, 0.3-0.5S T.D., Hi-Shock
401-77X	120/208VAC, 4W, 0.5-10 Sec. T.D., Lowest of 3
401-79X	480VAC, 3W, 0.2-0.3 Sec. T.D., Suppression
401-80X	76VAC, 3W, 53-76V Range
401-81X	120/208VAC, Sim. to 401-12X with 48VDC Contacts
401-82X	104VAC, 3W, Similar to WUV-3-104
401-83SX	120/208VAC, MIL-R-2033A
401-84X	180VAC, 3W, Similar to WUV-3-180
401-85SX	480VAC, Similar to 401-25SX except 480V
401-86SX	380VAC, Similar to 401-25SX except 380V
401-87SX	240VAC, Similar to 401-25SX except 240V
401-90X	120/208VAC, 4W, 0.5 Sec. T.D.
401-93X	480VAC, 3W Fast Oper. 50mS., Suppression
401-97X	69/120VAC, Lowest of 3
401-98X	480VAC, Sim. to 401TD-9HX with 2.0 Sec. T.D.
<b>AC, THREE PHASE, 400 HZ</b>	
403X	120/208VAC, 4W
403-1X	115/200VAC, 4W, 35-400mS T.D.
403-1SX	115VAC, 3W, Hi-Shock
403-2X	120VAC, 3W
403-3X	120/208VAC, 4W, 1.0 Sec. T.D.
403-4X	254/440VAC, 4W
403-5X	120/208VAC, 4W, 2 N.C. Contacts

403-7SX	480VAC, 3W, T.D., Hi-Shock
403-10X	120/208VAC, 4W, 10A Contacts
403-11X	480VAC, 4W, 60% to 80% Range
403-13X	120/208VAC, 4W, 0C to +90C
403-14X	575VAC, 3W, 400-500V Range
403-15X	120/208VAC, Sim. to 403-13X with Latching Circuit
403-16X	120/208VAC, Sim. to 403X with Conformal Coating

### AC THREE PHASE, CLOSE DIFFERENTIAL

D101-3X	Similar to D101X, -55C to +85C
D101-5X	120VAC, 50-500Hz, Military
D101-9X	120VAC, 50-500Hz, 0.5 Sec. T.D.
D101-11X	120VAC, 50-500Hz, 120-150VAC Adjust, N.C. Cont.
D101-12X	120VAC, Similar to D101X but 60-120VAC Range
D101-13X	120VAC, Similar to D101X but 3 N.C. Contacts
D101-14X	208VAC, Similar to D101-6X but 3 N.C. Contacts
D101-15X	480VAC, 50-500Hz, Spike Suppressors
D101-16X	480VAC, Similar to D101-7X but 3 N.C. Contacts
D101-17X	120VAC, 0.4A 120VDC Contact, -20 to +85 deg C
D101-18X	120VAC, Similar to D101X but Spike Suppression
D101-19X	208VAC, Similar to D101-6X but Spike Suppression
D101-20X	240VAC, Similar to D101-4X but Spike Suppression
D101-21X	380VAC, Similar to D101-10X but Spike Suppression
D101-24X	240VAC, 3 N.C. Contacts
D101-25X	208VAC, 3 N.C. Contacts, Spike Suppression
D101-26X	277VAC, 50-500Hz, 66-100% Adjustable
D101-27X	120VAC, Sim. to D101X, withstand 208V continuous
D101-29X	415VAC, 50-500Hz
D101-30X	380VAC, 50-500Hz, 3 N.C. Contacts
D101-31X	525VAC, Spike Suppression
D101-32X	120VAC, 50-500Hz, 5 Sec T.D.

### DC

400DCX	120VDC, 85-120V Range
400DC-HX	120VDC, 85-120V Range, 125VDC 2A Contacts
400DC-IX	28VDC, 15-29V Range
400DC-2X	240VDC, 180-220V Range
400DC-3X	62.5VDC, 40-65V Range
400DC-4X	305VDC, 200-300V Range
400DC-5X	5.6VDC, 4-6V Range, 120VAC Cont
410DCX	28VDC, 16—29V Range
410DC-SX	28VDC, 16-29V Range, Hi-Shock, MIL-R-57
410DC-1X	28VDC, 15-32V Range, 1.5V Differential
410DC-5X	24VDC, 16-29V Range, Suppression
410DCTDX	28VDC, 0.5-20 Sec. T.D.
411DCX	12VDC, 9-12 V Range
411DC-1X	15VDC, 11-15V Range
411DCTDX	12VDC, 0.5-20 Sec. T.D.
420DCX	60VDC, 40-65V Range

## Additional Relays (Continued)

420DC-4X	48VDC, 32-48V Range	250-12X	120VAC, Sim. to 250X, MIL-R-5757 2A
420DC-5X	48VDC, 20-48V Range	250-14XAC	67VAC, Sim. to 250-3X with removable cover
420DC-6X	70VDC, 50-70V Range	250-17X	120VAC, Sim. to 250X plus suppression
420DC-8X	32VDC, 33-40V Range (Pick-Up)	250-19X	120VAC, Sim. to 250X with 2 N.O. Contacts
420DC-9X	48VDC, Similar to 420DC-4X with 2 N.O. Contacts	250-22X	240VAC, 1-2 Sec. TD on Drop Out
420-470 SUFFIX	SUFFIX : "A" 2 N.O. Contacts "B" 2 N.C. Contacts	250-23X	120VAC, Sim. to 250X but -40C to +52C
430DCX	120VDC, 85-120V Range	250-27X	139VAC, Same as 250-12X except voltage
430DC-HX	120VDC, 85-120V Range, 125VDC 3A Contacts	250-28X	138VAC, Same as 250-10X except voltage
430DC-1X	140VDC, 105-140V Range	250-29HX	120VAC, 50-400Hz., 125VDC 3A Contacts
430DC-2X	140VDC, 105-140V Range, 0.5 Sec. T.D., Suppression	250-30X	480VAC
430DC-3X	120VDC, 50-80V Range	250-31X	240VAC, Fast Trip 25mS
430DC-4X	120VDC, 85-120V Range, 0.5 Sec. T.D., Set at 90V	250-32HX	480VAC, 100Hz, 1Sec TD, 120V 3ADC Contacts
430DC-5X	125VDC, 90-125V Range, Spike Suppression	250-33HX	480VAC, 25Hz, 1 Sex TD, 120V 3ADC Contacts
430DC-6X	125VDC, 105-140V Range, 3.0-5.0 Sec. T.D.	250-34X	120VAC, 72-120-160V Range, Hi Shock
430DC-7X	170VDC, 120-170V Range	250-35X	230VAC, Sim. to 250-22X, 3.0 Sec. TD
430DC-8X	120VDC, 85-120V Range, 2 N.C. Contacts	250-36X	120VAC, 84-120-150V Range, Hi Shock, -40C to 70C
430DC-9X	100VDC, 35-50V Range	250-37HX	120VAC, 25 Hz, 1 Sec. TD, 120V 3ADC Contacts
430DC-10X	120VDC, 85-120V Range, 2 N.O. Contacts	250-38X	240VAC, Two N.O. Contacts
440DCX	240VDC, 168-240V Range	250-39X	120VAC, Similar to 250X, Range +/- 35%
440DC-HX	240VDC, 168-240V Range, 125VDC 3A Contacts		
440DC-1X	280VDC, 190-260V Range	251SX	<b>AC, SINGLE PHASE, 50-400HZ</b> 120/208VAC, Sim. to 251X with Hi Shock
450DCX	305VDC, 230-305V Range	251-1X	120/208VAC, 4W, 0.50 Sec. TD NSN 5895-00-139-0337
450DC-HX	305VDC, 230-305V Range, 125VDC 3A Contacts	251-4X	139/240VAC, 4W
450DC-1X	305VDC, 230-305V Range, 2 N.C. Contacts	251-5X	120/208VAC, 4W, Two N.C. Contacts
460DCX	405VDC, 315-415V Range	251-8X	120/208VAC, 4W, 1.2 Sec. TD
460DC-HX	405VDC, 315-415V Range, 125VDC 3A Contacts	251-10X	110/190VAC, 4W
460DC-1X	405VDC, 300-330V Range	251-13X	120/208VAC, Sim. to 251X except -40C to 52C
460DC-3X	405VDC, 300-425V Range	251-14X	120/208VAC, 4W, Withstand 220/380V Continuous
460DC-4X	432VDC, 275-325V Range	251-15X	120/208VAC, Sim. to 251X with Transient Protection
460DC-5X	470VDC, 300-425V Range	251-16X	120/208VAC, 1.2 Sec. TD, Transient Protection
470DC	560VDC, 400-500V Range	251-17X	120/208VAC, Similar to 251X, 208V 7.5A Contacts
470DC-1X	585VDC, 400-500V Range	251-18X	120/208VAC, Highest/Lowest of three, TD Adjust 12VDC control
	<b>DC TIME DELAY</b>	251-19X	120/208VAC, Highest/Lowest of three, TD Adjust 120VAC control
420DCTDX	48VDC, 32-48V Range, 0.5-20 Sec. T.D.	251-20X	120/208VAC, Highest/Lowest of three, TD Adjust, 24VDC Control
430DCTDX	125VDC, 83-125V Range, 0.5-20 Sec. T.D.	251-21X	120/208VAC, Sim. to 251X, 0.5Sec. TD
440DCTDX	250VDC, 166-250V Range, 0.5-20 Sec. T.D.	251-22X	115/200VAC, Sim. to 251X, 0.75Sec. TD
	<b>OVER/UNDERVOLTAGE RELAYS</b>	253-HX	230VAC, 3W, 48VDC 3A Contacts
	<b>AC, SINGLE PHASE</b>	253-1X	230VAC, 3W, Spike Suppression
250SX	120VAC, Hi-Shock	253-1HX	230VAC, 3W, Spike Suppression, 125VDC Contacts
250-1X	120VAC, 72-120V, Mil, NSN 6125-00-091-0969	253-3X	230VAC, 3W, 1.0 Sec. TD
250-2X	120VAC, 1.2 Sec. Time Delay	253-5X	230VAC, 3/4W, 2 N.C. Contacts, -51C to +71C
250-3X	67VAC, UV 30-67V, OV 67-91V	253-6X	230VAC, 3W, 3.0 Sec. TD
250-4X	26VAC, 28VDC Control, Connector	254-1X	415VAC, 3W, 290-415-519V
250-5X	240VAC, Two N.C. Contacts	254-2X	220/380VAC, 4W, 2 N.C. Contacts
250-6X	240VAC, One N.O., One N.C. Contact	254-3X	416VAC, 3/4W, 2 N.C. Contacts, -51C to 71C
250-6HX	240VAC, 120VDC, 3A Contact	255-HX	460VAC, 3W, 125VDC 3A Contacts
250-7X	120VAC, 3 Sec. Time Delay	255-1X	460VAC, 3/4W, Spike Suppression
250-8X	100VAC	255-2X	480VAC, 3W, High Shock
250-10X	120VAC, Fast Trip, 25mS	255-3X	495VAC, 3W, 3.0 Sec. TD
250-11X	120VAC, Set at 97V and 156V		

## Additional Relays (Continued)

255-4X	460VAC, 3W, 2 N.O. Contacts, EMD # 9333490
255-5X	460VAC, 3W, Sim. to 255-4X, MIL-R-5757, 10A Relay
255-6X	460VAC, 3W, EMD# 9337151
255-7X	460VAC, 3W, Sim. to 255X, Fast operating, 40mSec.
255-8X	480VAC, 3W, 5.0 Sec. fixed TD, 120VAC Control
255-9X	480VAC, 3W, Sim. to 255-8X except +/- 10% Setting

### AC, SINGLE PHASE, 50-400HZ

256-1X	600VAC, 3W, 60Hz, 2 N.O. Contacts, EMD Canada
256-2X	575VAC, 3W, GM# 6964912 Rev. A

### DC

250DC-HX	24VDC, 16-24-30V Range, 48VDC 3A Contacts
250DC-1X	28VDC, MIL Shock and Vibration
250DC-2X	26VDC, UV 20-30V, OV 26-36V
250DC-3X	28VDC, 20-28-35V Range, Hi Shock, -40C to 70C
250DC-4X	14VDC, Commonwealth Edison
250DC-5X	28VDC, Commonwealth Edison
251DC-1X	48VDC, Removable Cover
251DC-2X	35VDC, UV 23-30V, OV 40-52V
251DC-3X	30VDC, UV 21-27V, OV 30-40V
251DC-HX	48VDC, 32-48-60V, 48VDC 3A Contacts
251DC-4X	60VDC, 45-60-75VDC, 2N.O. 120VAC Contacts
252DCX	120VDC, 85-120-150V Range
252DC-1X	130VDC, 80-130/120-150V Range
252DC-1HX	125VDC, 85-125/125-160V, 48VDC 3A Contacts
252DC-2X	130VDC, 80-130/120-150V, Removable Cover
253DCX	250VDC, 175-250-315VDC Range
253DC-HX	250VDC, 175-250-315VDC, 48VDC 3A Contacts

### REVERSE POWER RELAYS

#### AC, SINGLE PHASE

710-HX	120/220/266VAC, 125VDC 3A Control
710-PX	120/220/266VAC, 0.2-1.0A, Spike Suppression
710-1X	120/220/266VAC, 125VDC 1/4A Control
710-3X	120VAC (L-N), 1 Phase, 3-5A

#### 120/220/266VAC. SINGLE PHASE TIME DELAY

710TD-1X	0.05-0.25A, 0.5-10 Sec. T.D. with Knobs
710TD-5X	2 N.O. Contacts
710TD-7X	60Hz, Reverse Inductive
710TD-7PX	Similar to 710TD-7X with Suppression
710TD-8X	Similar to 710TDX with -55F to +150F
710TD-9X	Similar to 710TDX with Suppression
710TD-12X	Similar to 710TDX, 125VDC 2A Contacts
710TD-14X	50Hz, Reverse Inductive
720TD-14X	120 V, L-L, 50Hz, Reverse Inductive
721TD-14X	230 V, L-L, 50Hz, Reverse Inductive
722TD-14X	380 V, L-L, 50Hz, Reverse Inductive
723TD-14X	460 V, L-L, 50Hz, Reverse Inductive
724TD-14X	575 V, L-L, 50Hz, Reverse Inductive

725TD-14X	415 V, L-L, 50Hz, Reverse Inductive
726TD-14X	100 V, L-L, 50Hz, Reverse Inductive
727TD-14X	185 V, L-L, 50Hz, Reverse Inductive

### PHASE SEQUENCE RELAYS

#### AC, THREE PHASE

900-2PX	208-230VAC, Spike Suppression
900-4X	208VAC, 50/60 Hz
900-5X	120VAC, 50/60Hz
900-8X	120VAC, 60 Hz, 125VDC 2A Contacts
900-10X	120VAC, 60 Hz, Spike Suppression
901-1X	440VAC, 60 Hz, 5A Contacts
901-5X	575VAC, Porcelain Term., AZ Relay
901-6X	460VAC, 60 Hz, Spike Suppression
901-SX	440VAC, 55-65HZ, HI-Shock
910-1X	220/440VAC, 60 Hz, N.O. Contacts
910-2X	220/440VAC, 60 Hz, Reversed Contact Operation
910-3X	220/440VAC, 60 Hz, Porcelain Term., Sigma Relay
920X	380VAC, 50 Hz
920-1X	380VAC, 50 Hz, Mounting per 21-037
920-2X	380VAC, 50 Hz, Porcelain Terminals, Sigma Relay
920-3X	416VAC, 50 Hz, 5A Contacts
920-5X	220/380VAC, 50 Hz
920-6X	440VAC, 50 Hz
930X	208VAC, 400 Hz
930-1X	208VAC, 400Hz, 2A at 28VDC Contacts, Energized A-B-C, 5A
930-3X	400VAC, 400Hz
930-4X	400VAC, 2 N.C. Contacts, -51C to +71C
931X	120VAC, 400 Hz.
932-5X	115/200VAC, 400Hz, 2A Contact, Hi-Shock
932-7X	230/400VAC, 400Hz

### PHASE FAILURE RELAYS

980X	120VAC, 60 Hz, no T.D. on Starting
981X	230VAC, 60 Hz, no T.D. on Starting
982X	460VAC, 60 Hz, no T.D. on Starting
983X	380VAC, 60 Hz, no T.D. on Starting
984X	575VAC, 60 Hz, no T.D. on Starting
985X	525VAC, 60 Hz, no T.D. on Starting

1980X	120VAC, 60 Hz
1981X	230VAC, 60 Hz
1982X	460VAC, 60 Hz
1983X	380VAC, 50 Hz
1984X	575VAC, 60 Hz
1985X	525VAC, 60 Hz
1986X	415VAC, 50 Hz
1987X	380VAC, 60 Hz
SUFFIX:	"-S": Time Delay (0.5 - 30 Sec.)
	"-3S": Factory Set Time Delay (0-60 Sec.)
1981-1SX	230VAC, Similar to 1981X except 50 Hz
1980-2SX	120VAC, Similar to 1980X except N.C. Contacts

#### AC, THREE PHASE, VOLTAGE SENSITIVE

1003X-60HZ	380VAC, Similar to 1003X except 60Hz
1009X	415VAC, 50 Hz
1010X	208VAC, 50 Hz



**Additional Relays** (Continued)

1001X-1010X SUFFIX "-1": N.C. Contact (example: 1004-1X)  
 1001X-1010X SUFFIX "-2": -53C to +70C, 2% Drift below -20C  
 1001X-1010X SUFFIX "-3": 400Hz, N.O. Contacts  
 1001X-1010X SUFFIX "-T": Spike Suppression  
 1001X-1010X SUFFIX "-H": 125VDC 3A Contacts  
 1001X-1010X SUFFIX "-9" 1 N.O. & 1 N.C. Contacts  
 1001X-1010X SUFFIX "-12": Spike Supp., 125VDC 3A Contacts  
 1001X-1010X SUFFIX "-13": 1N.O + 1 N.C. 125VDC 3A Contacts

**OVERCURRENT RELAYS**

1100X 120VAC, 1-5A Range  
 1100-1X 120VAC, 0.5-5A Range, Remote Adjust  
 1100-2X 120VAC, 0.5-5A Range  
 1100-2SX 120VAC, 0.5-5 A Range, Hi-Shock, 2A Contacts  
 1100-9X 120VAC, 1-5A, Fast Operating  
 1100-11X 120VAC, 1-5A, 3% Diff., Suppression 2.5KV  
 1100-13X 120VAC, 1-5A, 2 N.C. Contacts  
 1100-14X 120VAC, 7-30A, 2 N.C. Contacts  
 1100-15X 120VAC, 2-10A, 2 Sec. T.D.  
 1100-17X 120VAC, 1-5A, 2 Sec. T.D.  
 1100-18X 120VAC, 0.05-0.15A, 5A Max, 400 Hz  
 1100-19X 24VDC, 1-5A Range  
 1100-20X 120VAC, 1-5A, Suppression (15 times in-rush)  
 1100-21X 74VDC, 7-30A, 50mS T.D., Shock & Vibration  
 1100-22X 120VAC, 1-5A Remote Adjust  
 1100-23X 125VDC, 0.25-1.8A, 1 N.O.  
 125VDC 2A Contact  
 1100-24X 32VDC, 1-5AAC Range  
 1100-25X 120VAC, 0.25-1.25A  
 1100-26X 120VAC, 0.3-1.5A, Withstand 5A  
 1100-27X 220VAC, 1-5A Range, 220VAC Contacts  
 1100-32X 120VAC, Undercurrent 1-10A Adj,  
 0.2-5 Sec. T.D.  
 1100-35X 120VAC, 0.1-0.4A Range  
 1100-36X 74VDC, 4-20A, 50mS T.D., Shock & Vibration  
 1100-37X 24VDC, 0.1-0.3A Range  
 1100-38X 74VDC, Similar to WC1-74DC-5

**AC, SINGLE PHASE, ADJ. DIFFERENTIAL**

D1100X 120VAC, 1-5A Range  
 D1100-2X 220VAC, 1-5A Range  
 D1100-3X 120VAC, 4-12A Range  
 D1100-4X 230VAC, 4-12A Range  
 D1100-5X 460VAC, 4-12A Range  
 D1100-6X 120VAC, 1-5A Range, 1-2 Sec. T.D.  
 D1100-7X 120VAC, 0.7-5A Range,  
 125VDC 0.5A Contacts  
 D1100-8X 120VAC, 5-15A Range

**AC, SINGLE PHASE, TIME DELAY**

1100TDX 120VAC, 1-5A Range, 0.5-30 Sec. T.D.  
 1100TD-HX 120VAC, 1-5A, 0.5-30 Sec. T.D.,  
 125VDC 3A Cont.  
 1100TD-SX 120VAC, 1-5A Range, 0.5-20 Sec. T.D.,  
 Hi-Shock  
 1100TD-1X 240VAC, 1-5A Range, 0.5-30 Sec. T.D.  
 1100TD-2X 24VDC, 1-5AAC Range, 0.5-30 Sec. T.D.  
 1100TD-3X 120VAC, 0.5-5A Range, 0.5-30 Sec. T.D.  
 1100TD-5X 120VAC, 0.5-2.5A Range, 0.5-30 Sec. T.D.  
 1100TD-6X 120VAC, 1-5A , 0.2-20 Sec. T.D.,  
 Manual Reset  
 1100TD-8X 220VAC, 2-10A Range, 220VAC 5A Contacts

1100TD-9X 24VDC, 0.5-5AAC Range, 0.5-20 Sec. T.D.  
 1100TD-10X 120VAC, Sim. to WCT1-120AC-5 w/  
 removable cover  
 1100TD-11X 120VAC, Sim. to WCT1-120AC-5, 1-5 Min. T.D.  
 1100TD-12X 120VAC, Sim. to WCT1-120AC-5,  
 0.5-5 Sec. T.D.  
 OPTION 1: 0.2A to 1.0A Range  
 2.5: 0.5A to 2.5A Range  
 5: 1.0A to 5.0A Range  
 10: 2.0A to 10.0A Range

**AC, THREE PHASE, TIME DELAY**

1130TDX 120VAC, 1-5A, 0.5-20 Sec. T.D.  
 1130TD-1X 24VDC, 1-5A, 0.5-20 Sec. T.D.  
 1130TD-2X 120VAC, 1-5A, 0.5-20 Sec. T.D., Suppression  
 1130TD-3X 120VAC, 1-5A, 0.5-60 Sec. T.D.,  
 2 N.C. Contacts  
 1150X 120VAC, 4.35A, 0.5-5 Sec. T.D.  
 1150-1X 120VAC, 4.26A, 0.5-5 Sec. T.D.  
 1150-2X 120VAC, 3.72A, 0.5-5 Sec. T.D.  
 1150-4X 120VAC, 1-5A, (P.G.E.)  
 1150-6X 120VAC, 1-5A, 2-3 Sec. T.D. on D.O.  
 1150-8X 120VAC, Same as 1150-2X with  
 2 N.O. Contacts  
 1150-10X 120VAC, 1-5A, 2 Sec. T.D.  
 1150-10SX 120VAC, 1-5A, 2 Sec. T.D., Hi-Shock  
 1150-11X 120VAC, 2.5-5A, 400Hz, Special T.D. Curve  
 1150-12X 120VAC, 2.5-5A, 60Hz, Special T.D. Curve  
 1150-14X 120VAC, 2.5-5A, 400Hz, T.D. Curve, Aux. N.O.  
 1150-15X 24VDC, 1.2-2.2A, 60Hz, T.D. Curve, (Solar)  
 1150-16X 24VDC, 2.5-4.3A, 60Hz, T.D. Curve, (Solar)

**VOLTAGE RESTRAINT**

1200X 120VAC, 1-5A, 24VDC Control  
 1200-1X 120VAC, 1-5A, 12VDC Control  
 1200-4X 120/208VAC, 1-5A, 3 Phase, 24VDC Control  
 1200-5X 120VAC, 1-5A, 3 Phase, 24VDC Control  
 1200-6X 120VAC, 1-5A, 3 Phase, 24VDC Control,  
 Suppression  
 1200-7X 120VAC, 1-5A, 1 Phase, 120VAC Control  
 1200-8HX 120VAC, 1-5A, 3 Phase, 125VDC Control  
**DC**  
 1100DCX 120VAC, 10-50mV ext. Shunt, 5A Contacts  
 1100DC-1X 230VAC, 0-10VDC ext. Shunt, 5A Contacts  
 1100DC-2X 120VAC, 10-50mV ext. Shunt,  
 Transistor Output  
 1100DC-3X 120VAC, 0.2-0.6ADC with 0.125 ohm Shunt  
 1100DC-4X 28VDC, 10-50mV, Inverter, ext. Shunt,  
 2 Sec. T.D.  
 1100DC-6X 125VDC, 10-50mV, Inverter,  
 125VDC 3A Contacts  
 1100DC-7X 120VAC, 10-50mV, Inverter,  
 125VDC 3A Contacts  
 1100DC-8X 120VAC, isolated outputs  
 1100DC-9X 250VDC, 150mV Shunt, Hi-Shock,  
 +/- 20% Adj.  
 1100DC-10X 120VAC, 50-150mV  
 1100DC-11X 220VDC, 5-25mV, 1-25 Sec. T.D.,  
 Inverse Current  
 1100DC-13X 120VAC, 20-35mV, Hi-Shock  
 1100DC-15X 12VDC, 10-50mV, Inverter  
 1100DC-17X 74VDC, 10-50mV, Inverter  
 1100DC-20X 120VAC, Similar to 1100DCX except 4-25mV



**Additional Relays** (Continued)

**UNDERCURRENT RELAYS**

21-693-1 Self Contained CT, 120VAC Control  
 21-693-2 Self Contained CT, 230VAC Control

**CURRENT DIFFERENTIAL**

1350X 24VDC, 0.1-0.5A Range  
 1350PX 24VDC, 0.1-0.5A Range, Suppression, 1 N.O. Contact  
 1350SX 24VDC, 0.1-0.5A Range, High Shock  
 1350-1X 24VDC, 0.1-0.5A Range, 1 N.C. Contact  
 1350-3X 48VDC, 0.1-0.5A Range  
 1351X 120VAC, 0.1-0.5A Range  
 1351PX 120VAC, 0.1-0.5A Range, Suppression  
 1351SX 120VAC, 0.1-0.5A Range, High Shock  
 1351-1X 120VAC, 0.1-0.5A Range, 1 N.C. Contact  
 1351-2X 120VAC, 2 Sec. T.D. on application of voltage  
 1351-4X 120VAC, 0.1-0.5A Range, Fast, 125VDC Contacts

**PARALLELING (SYNCHRO-CHECK) RELAYS**

1880X 200VAC, 1 N.O. & 1 N.C. Contact  
 1890X 90VAC, 1 N.O. & N.C. Contact  
 SUFFIX "-A": Two Normally Open Contacts  
 "-B": Two Normally Closed Contacts  
 "-P": Spike Suppression  
 "-7": 0.025 Second Time Delay  
 "-9": 125VDC 2A Contacts  
 "-13": 0.250 Second Time Delay

**DEAD BUS TYPE**

1880DBX 200VAC, 1 N.O. & 1 N.C. Contact  
 1890DBX 90VAC, 1 N.O. & 1 N.C. Contact  
 SUFFIX "-A": 2 Normally Open Contacts  
 "-B": 2 Normally Closed Contacts  
 "-S": High Shock  
 "-2": 2 N.O. Contacts, Cond. 5 same as 3  
 "-3": Condition 1 reversed  
 "-5": 12 deg. to 36 deg. adjustment  
 "-8" 3 Phase, Phase Sequence  
 "-9": 125VDC 2A Contacts  
 "-12": 25 Hz, 125VDC 3A Contacts

**DOUBLE DEAD BUS (EITHER BUS DEAD)**

1880DDBX 200VAC, 1 N.O. & 1 N.C. Contact  
 1890DDBX 90VAC, 1 N.O. & 1 N.C. Contact  
 SUFFIX "-A": 2 Normally Open Contacts  
 "-B": 2 Normally Closed Contacts  
 "-9": 125VDC Contacts; 2A res. , 1A ind.

**DOUBLE DEAD BUS, UNDERVOLTAGE**

2800-120 120VAC, Ph. Ang. 5-25 deg., UV: 70% D.O. 80% P.U.  
 2800-208 208VAC, Ph. Ang. 5-25 deg., UV: 70% D.O. 80% P.U.  
 2800-240 240VAC, Ph. Ang. 5-25 deg., UV: 70% D.O. 80% P.U.  
 2800-380 380VAC, Ph. Ang. 5-25 deg., UV: 70% D.O. 80% P.U.  
 2800-416 416VAC, Ph. Ang. 5-25 deg., UV: 70% D.O. 80% P.U.  
 2800-440 440VAC, Ph. Ang. 5-25 deg., UV: 70% D.O. 80% P.U.

2800-480 480VAC, Ph. Ang. 5-25 deg., UV: 70% D.O. 80% P.U.  
 2800-600 600VAC, Ph. Ang. 5-25 deg., UV: 70% D.O. 80% P.U.

**PHASE BAND MONITOR**

2850X 208/230/460 V, 5-60 deg. Range, 60 Hz  
 2850-1X 208/240/380/480 V, 5-45 deg. Range, 50/60 Hz

**OVERFREQUENCY RELAYS**

WOF-12-100110 120VAC, 100-110 Hz. Range  
 SUFFIX "-1": 0.2% Max. Differential  
 "-T": 0.5-20 Sec. Time Delay  
 "-2T": 60 Second Time Delay  
 "-S": High Shock

23-050X 120VAC, 50-60 Hz  
 23-060X 120VAC, 60-70 Hz  
 23-400X 120VAC, 400-450 Hz

**UNDERFREQUENCY RELAYS**

22-050X 120VAC, 50-60 Hz  
 22-060X 120VAC, 60-70 Hz  
 22-400X 120VAC, 400-450 Hz

**FREQUENCY RELAYS (Over or Under)**

25-050HX 120VAC, 40-50-60 Hz, 125VDC 3A Contacts  
 25-050SX 120VAC, 40-50-60 Hz, High Shock  
 25-050-1X 120VAC, 40-50-60 Hz, 2 N.C. Contacts  
 25-050-2X 120VAC, 40-50-60 Hz, 1.2 Sec. Time Delay  
 25-060HX 120VAC, 50-60-70 Hz, 125VDC 3A Contacts  
 25-060SX 120VAC, 50-60-70 Hz, High Shock  
 25-060-1X 120VAC, 50/60 Hz +/-10% on each Frequency  
 25-060-2X 120VAC, 50-60-70 Hz, 0.4 Hz Differential  
 25-060-3X 120VAC, 50-60-70 Hz, 2 N.C. Contacts  
 25-060-4X 120VAC, 50-60-70 Hz, 2 N.O. Contacts  
 25-060-5X 120VAC, 50-60-70 Hz, 2 N.O., 10A MIL-R-5757  
 25-060-7X 120VAC, EMD #9337150, Set 57.4 & 62.6 +/-0.6 Hz  
 25-060-8X 120VAC, 50-60-70 Hz, 1 Sec. T.D.  
 25-060-10X 120VAC, Spike Suppression  
 25-060-12X 104VAC, 50-60-70 Hz  
 25-060-14X 240VAC, 50-60-70 Hz  
 25-060-18X 120VAC, 50-60-70 Hz, 1 Sec. T.D., Suppression  
 25-060-19X 120VAC, 50-60-70 Hz, 0.5-10Sec. T.D., 12VDC Ctrl.  
 25-060-20X 120VAC, 50-60-70 Hz, 0.5-10Sec. T.D., 24VDC Ctrl.  
 25-100X 120VAC, 90-100-110 Hz  
 25-400X 120VAC, 350-400-450 Hz  
 25-400-2X 120VAC, 350-400-450 Hz, 220VAC 5A Contacts  
 25-400-5X 120VAC, 350-400-450 Hz, Suppression  
 25-025T-1HX 480VAC, 20-25-30 Hz, 0.5-20Sec. T.D., 125VDC 3A Contacts  
 25-025T-2HX 120VAC, 20-25-30 Hz, 0.5-20Sec. T.D., 125VDC 3A Contacts  
 25-100T-1HX 480VAC, 90-100-110 Hz, 0.5-20Sec. T.D., 125VDC 3A Contacts  
 20-040-1X 100VAC, 40-50 Hz  
 20-040-2X 120VAC, 40-50 Hz, 1.5-2.0 Sec. T.D.



**Engineering Notes**

---

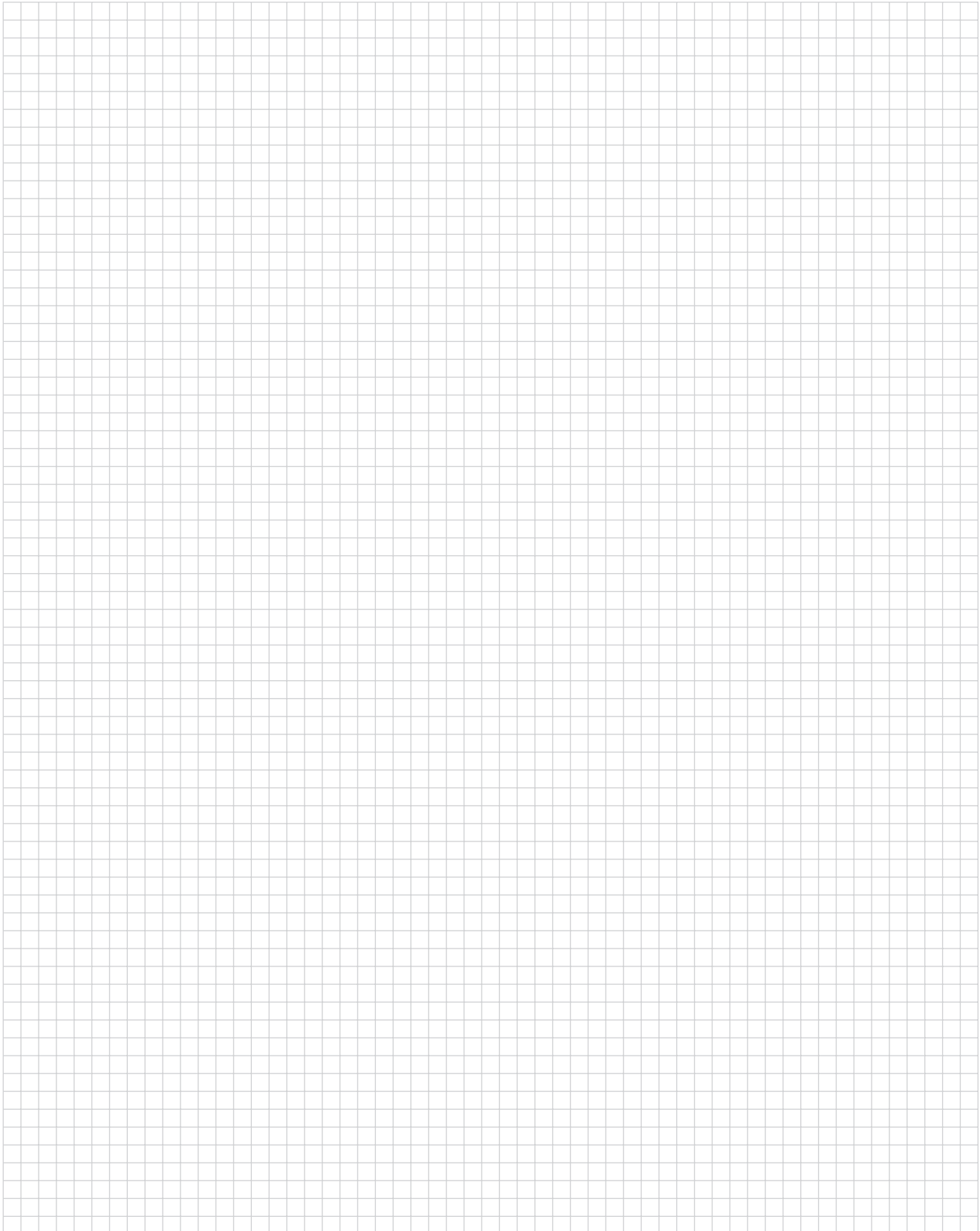

## X-ON Electronics

Largest Supplier of Electrical and Electronic Components

*Click to view similar products for [General Purpose Relays](#) category:*

*Click to view products by [TE Connectivity](#) manufacturer:*

Other Similar products are found below :

[APF30318](#) [JVN1AF-4.5V-F](#) [PCN-105D3MHZ](#) [5JO-10000S-SIL](#) [5JO-1000CD-SIL](#) [5JO-400CD-SIL](#) [LY2S-AC220/240](#) [LYQ20DC12](#)  
[6031007G](#) [6131406HQ](#) [6-1393099-3](#) [6-1393099-8](#) [6-1393122-4](#) [6-1393123-2](#) [6-1393767-1](#) [6-1393843-7](#) [6-1415012-1](#) [6-1419102-2](#) [6-](#)  
[1423698-4](#) [6-1608051-6](#) [6-1608067-0](#) [6-1616170-6](#) [6-1616248-2](#) [6-1616282-3](#) [6-1616348-2](#) [6-1616350-1](#) [6-1616350-8](#) [6-1616358-7](#) [6-](#)  
[1616359-9](#) [6-1616360-9](#) [6-1616931-6](#) [6-1617039-1](#) [6-1617052-1](#) [6-1617090-2](#) [6-1617090-5](#) [6-1617347-5](#) [6-1617353-3](#) [6-1617801-8](#) [6-](#)  
[1617802-2](#) [6-1618107-9](#) [6-1618248-4](#) [M83536/1-027M](#) [CX-4014](#) [MAHC-5494](#) [MAVCD-5419-6](#) [703XCX-120A](#) [7-1393100-5](#) [7-1393111-7](#)  
[7-1393144-5](#) [7-1393767-8](#)