

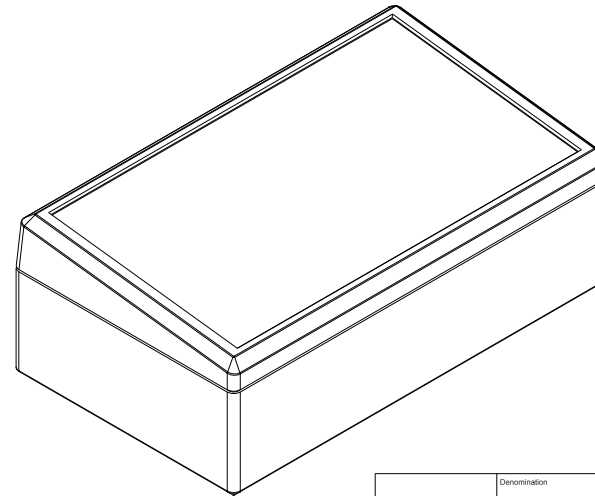

A-A

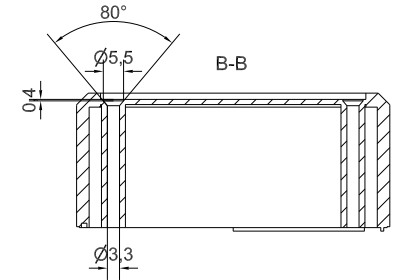
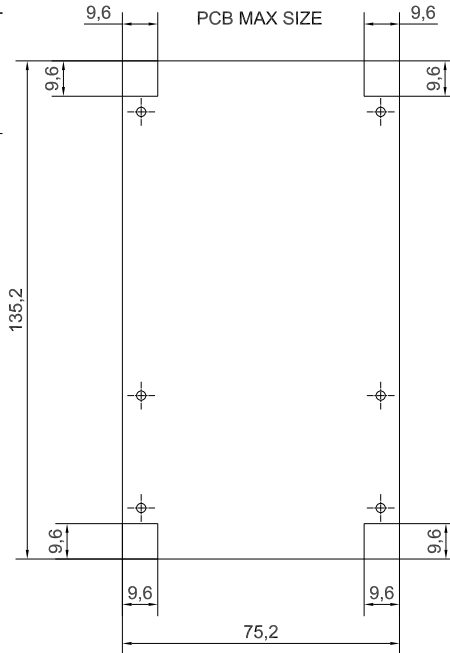
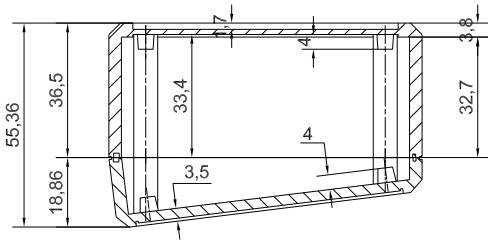

	Denomination	Assembly 770SP		Part. Number	770SP
	Subject to technical modification without prior notice. Tipographical and other errors do not justify any claim for damages. All dimensions should be verified using an actual moulded part.				
	This document contains proprietary information of TEKO S.p.a. and is tendered subject to the conditions that the information be retained in confidence not be reproduced or copied and not be used or incorporated in any product.			Date	06/10/2005
				Scale	Format design

X-ON Electronics

Largest Supplier of Electrical and Electronic Components

Click to view similar products for [Electrical Enclosure Accessories](#) category:

Click to view products by [Teko](#) manufacturer:

Other Similar products are found below :

[60121-06-028 C-325 Black](#) [71884-04-028 CM3-100 Black](#) [71884-18-028 LH43-200 Black](#) [71884-24-028 LH75-200 Black](#) [71885-01-028 CM6-150 Black](#) [72459-02-028 DM-3 BLACK](#) [72459-03-028 DM-4 BLACK](#) [81501-01-000 XPL, 9VB Black](#) [82402-01 PT-8 ALUM](#) [83541307GSKTSC](#) [1335GSKT3](#) [14101FP-PK](#) [BAS-5104](#) [CB-1263-BT](#) [HM BLACK PANEL](#) [61033-01-000](#) [115123-01-508 CN-RL RS](#) [115124-01-508 CN-XRL XRS](#) [115119-01-000 CN-RL RS](#) [115123-01-000 CN-RL RS](#) [60121-04-028 C-275 Black](#) [60128-01-072](#) [60222-01-028 CM6-225 Black](#) [60272-01-028 CM3-150 Black](#) [60851-01-028 CM69-120 Black](#) [62452-01-000 HML-9VB, EB Black](#) [71884-25-028 LH89-130 Black](#) [AXX2POSTBRCKT](#) [FUPMESK](#) [71884-23-028 LH75-130 Black](#) [8G820V40620](#) [DVC.3-95-80-75-M16-55](#) [096484E](#) [53801090](#) [53801115](#) [AXX2POSTBRCKT 918808](#) [OBOX-385-NBR-M](#) [60242-02-028 CM5-200 Black](#) [DIN 7603-AL-14-18-A](#) [DIN 7603-AL-16-20-A](#) [DIN 7603-AL-20-24-A](#) [DIN 7603-AL-24-29-A](#) [01-0009.00X3.5 ORING 80FPM BROWN](#) [171 PG42](#) [60121-05-028 C-300 Black](#) [71884-12-028 LH96-130 Black](#) [62178-01-028 CM69-180 Black](#) [71055-01-000 JM-42 Black](#) [FG13LH15A700S11](#) [IPV-67101-B](#)