

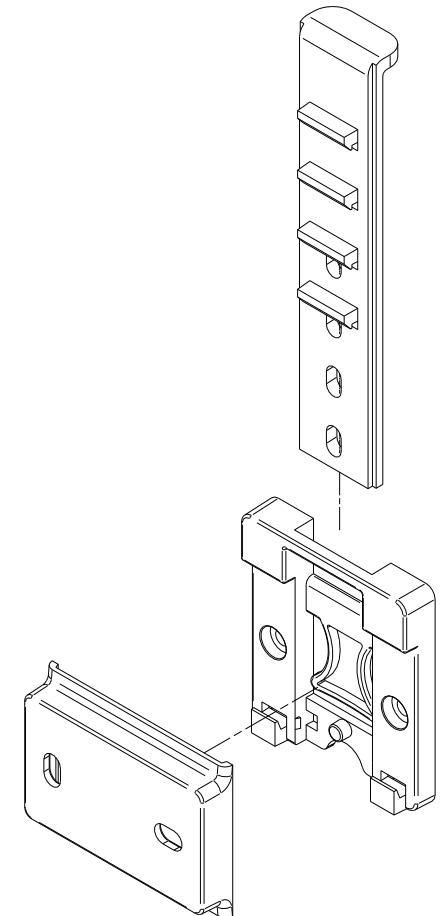

DR

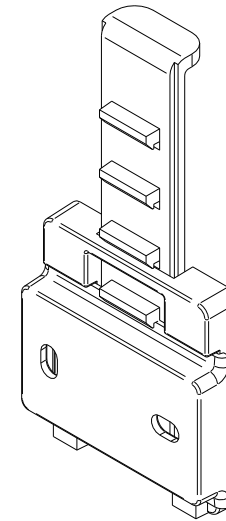
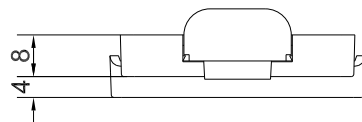
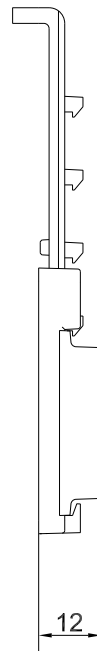
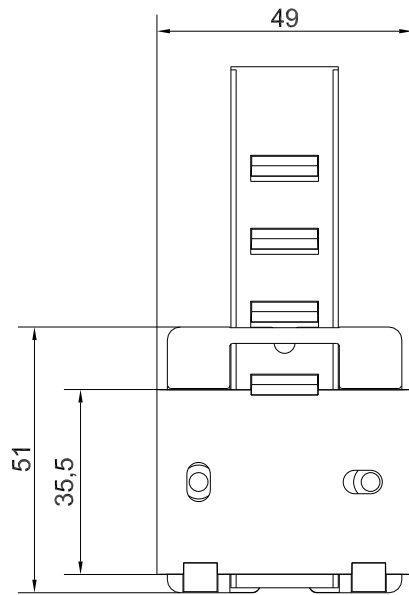

	Denomination	Part. Number	
	Assembly DR	DR	
	Subject to technical modification without prior notice. Tipographical and other errors do not justify any claim for damages. All dimensions should be verified using an actual moulded part.	Rev. Index	Scale
	This document contains proprietary information of <b>TEKO S.p.a.</b> and is tendered subject to the conditions that the information be retained in confidence not be reproduced or copied and not be used or incorporated in any product.	Date	Format design
	06/05/2005	A3	

## X-ON Electronics

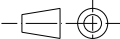
Largest Supplier of Electrical and Electronic Components

*Click to view similar products for [Enclosures, Boxes, & Cases](#) category:*

*Click to view products by [Teko](#) manufacturer:*

Other Similar products are found below :

[CR-425 PAINTED](#) [585-R-WH-PK](#) [M-10-PLATED](#) [60221-01](#) [60566-01-000](#) [HPL-9VB BATT DOOR](#) [M-16-LID-PLATED](#) [M18-PLTD](#) [M-21-LID-PLATED](#) [M-21-PLATED](#) [M-23-PLATED](#) [CU-281-MB](#) [6711GSKT](#) [71884-29-028](#) [LH45-100 Black](#) [7200B](#) [72868-510-000](#) [CNS-0000 Black](#) [72883-510-000](#) [CNS-0101 Black](#) [72906-510-000](#) [CNS-0407 Black](#) [73091-510-000](#) [CNM-0000-BLACK Kit](#) [73092-510-000](#) [CNM-0101 Black](#) [73108-510-000](#) [CNL-0303 Black](#) [73395-510-039](#) [CNS-0006 Bone](#) [74257-510-000](#) [CNL-0004](#) [MDC-1183-PLAIN-ALUM](#) [MDC-1183-PTD](#) [MDC-13104-PLAIN-ALUM](#) [MDC-211 - PAINTED IVORY/BEIGE](#) [MDC-321-PTD](#) [MDC-432-PLAIN-ALUM](#) [MDC-973-PTD](#) [76](#) [77153-01-028](#) [FLX6030](#) [83535-01-508](#) [PS-11296-G](#) [PS-11298-B](#) [116-508](#) [120-407](#) [120-412](#) [120-909](#) [120-455](#) [R272-100-000](#) [120-910](#) [R501-001-010](#) [R508-080-000](#) [R508-160-000](#) [R530-120-000](#) [R530-122-000](#) [R530-200-000](#) [R531-160-000](#) [R531-200-000](#) [R582-080-100](#)