



## TO-5 MAGNETIC-LATCHING COMMERCIAL RELAYS DPDT



SERIES	RELAY TYPE
722	DPDT basic

### DESCRIPTION

The magnetic-latching TO-5 relay, originally conceived and developed by Teledyne, has become one of the industry standards for low-level switching from dry circuit to 1 ampere. Designed for high-density PC board mounting, the 722 relay has become one of the most versatile ultraminiature relays available because of its small size and low coil power dissipation.

Unique construction features and manufacturing techniques provide excellent resistance to environmental extremes and overall high reliability.

#### The 722 feature:

- All welded construction.
- Unique uni-frame design providing high magnetic efficiency and mechanical rigidity.
- High force/mass ratios for resistance to shock and vibration.
- Advanced cleaning techniques provide maximum assurance of internal cleanliness.
- Precious metal alloy contact material with gold plating assures excellent high current and dry circuit switching capabilities.

The Series 722 magnetic-latching relays are ideally suited for applications where coil power dissipation must be minimized. The relays can be operated with a short duration pulse and after the contacts have transferred, no external coil power is required. The magnetic-latching feature of the Series 722 provides a "memory" capability, since the relays will not reset upon removal of coil power.

By virtue of its inherently low intercontact capacitance and contact circuit losses, the 722 relay has proven to be an excellent ultraminiature RF switch for frequency ranges well into the UHF spectrum. A typical RF application for the TO-5 relay is in handheld radio transceivers, wherein the combined features of good RF performance, small size, low coil power dissipation and high reliability make it a preferred method of Transmitter-Receive switching (see Figure 1).

ENVIRONMENTAL AND PHYSICAL SPECIFICATIONS	
<b>Temperature</b> (Ambient)	-65°C to +125°C
<b>Vibration</b> (General Note I)	10 g's to 500 Hz
<b>Shock</b> (General Note I)	30 g's, 6ms half sine
<b>Enclosure</b>	Hermetically sealed
<b>Weight</b>	0.1 oz. (2.9g) max.

### INTERNAL CONSTRUCTION

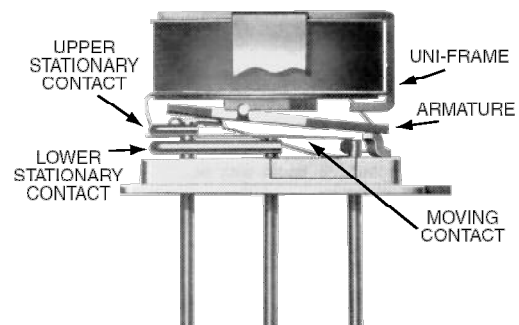

**SERIES 722**  
**GENERAL ELECTRICAL SPECIFICATIONS (@25°C)**

<b>Contact Arrangement</b>	2 Form C (DPDT)
<b>Rated Duty</b>	Continuous
<b>Contact Resistance</b>	0.15 Ω max.; 0.25 Ω max. afterlife at A / 28 Vdc
<b>Contact Load Rating (DC)</b>	Resistive: 1 A / 28 Vdc Inductive: 200 mA / 28 Vdc (320mH) Lamp: 100 mA / 28 Vdc (320mH) Low level: 10 to 50 μA @ 10 to 50 mV
<b>Contact Load Rating (AC)</b>	Resistive: 250 mA / 115Vac, 60 and 400 Hz (Case not grounded) 100 mA / 115 Vac, 60 and 400 Hz (Case grounded)
<b>Contact Life Ratings</b>	10,000,000 cycles (typical) at low level 1,000,000 cycles (typical) at 0.5 A / 28 Vdc resistive 100,000 cycles min. at all other loads specified above
<b>Contact Overload Rating</b>	2 A / 28 Vdc Resistive (100 cycles min.)
<b>Coil Operating Power</b>	290 mW typical at nominal rated voltage
<b>Contact Carry Rating</b>	Contact Factory
<b>Operate Time</b>	2.0 msec max. at nominal rated coil voltage
<b>Minimum Operatue Pulse</b>	6.0 ms width @ rated voltage
<b>Intercontact Capacitance</b>	0.4 pf typical
<b>Insulation Resistance</b>	1,000 MΩ min. between mutually isolated terminals
<b>Dielectric Strength</b>	350 Vrms (60 Hz) @ atmospheric pressure
<b>Negative Coil Transient (Vdc)</b>	2.0 Vdc Max.
<b>Diode P.I.V. (Vdc)</b>	60 Vdc Min.

**DETAILED ELECTRICAL SPECIFICATIONS (@25°C)**

BASE PART NUMBERS (722, 722D)		722-5 722D-5	722-12 722D-12	722-26 722D-26
<b>Coil Voltage (Vdc)</b>	<b>Nom.</b>	5.0	12.0	26.5
	<b>Max.</b>	6.0	16.0	32.0
<b>Coil Resistance (Ohms ±20%)</b>		61	500	2000
<b>Latch and Reset Voltage (Vdc)</b>	<b>Max.</b>	3.5	9.0	18.0

**PERFORMANCE CURVES (Note 2)**

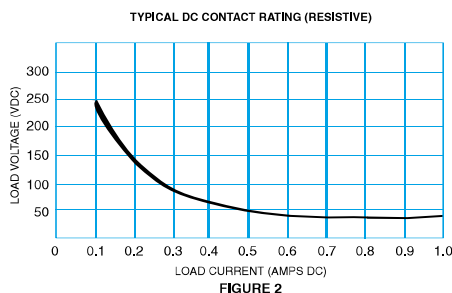
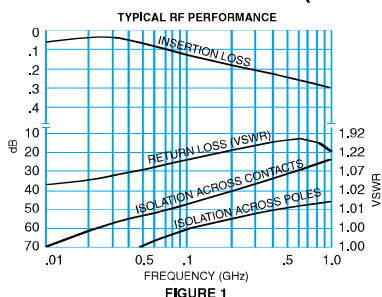

**GENERAL NOTES**

1. Relay contacts will exhibit no chatter in excess of 10 μsec or transfer in excess of 1 μsec.
2. "Typical" characteristics are based on available data and are best estimates. No on-going verification tests are performed.
3. Unless otherwise specified, parameters are initial values.
4. Relays can be supplied with a spacer pad. See appendix.

**SERIES 722**  
**OUTLINE DIMENSIONS**

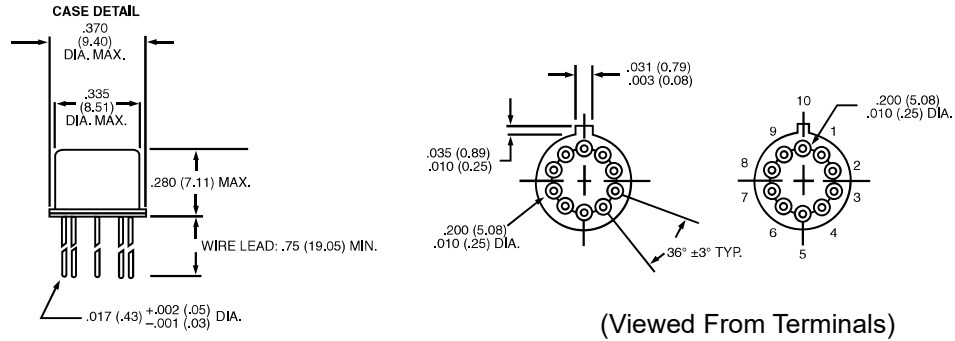

**SCHEMATIC DIAGRAMS**

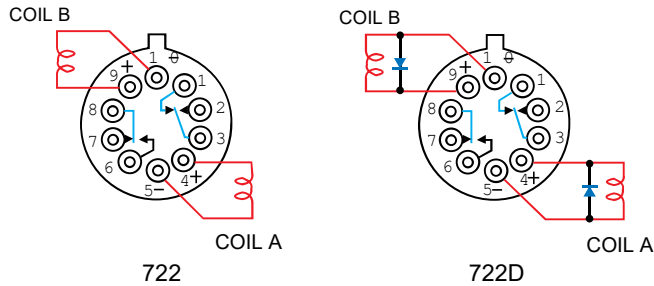

**Part Numbering System**

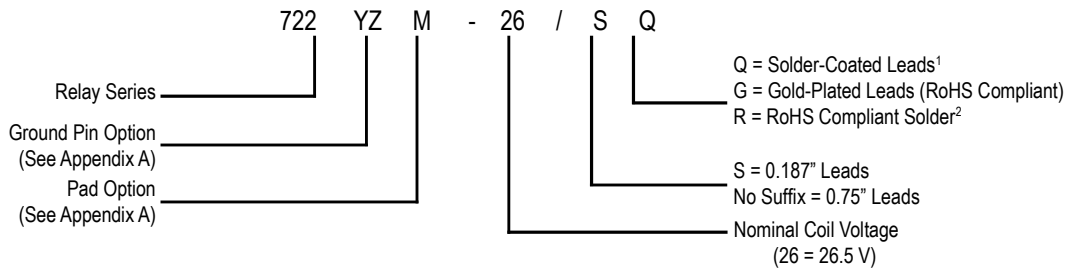

Note: Parts ordered without suffix may be supplied with Solder-Coated or Gold-Plated leads.  
<sup>1</sup> Parts ordered with Solder-Coated leads will have (Sn60/Pb40)  
<sup>2</sup> Parts ordered with RoHS Solder-Coated leads will have (Sn99.3/Cu0.7)

**NOTES:**

- DIMENSIONS ARE IN INCHES, METRIC EQUIVALENTS SHOWN IN [ ].**
- POSITIONS 5 AND 10 ARE FOR UNINSULATED CASE GROUND OPTIONS.**
- NO PROTRUSION BELOW BOTTOM OF HEADER WHEN GROUND PINS ARE INSTALLED**
- TO ORDER THE CASE GROUND OPTION, AFTER THE SERIES DESIGNATOR, ADD "Y" TO THE PART NUMBER FOR POSITION 5 OR "Z" TO THE PART NUMBER FOR POSITION 10.**
- UNLESS OTHERWISE SPECIFIED, TOLERANCES ON DIMENSIONS ARE ± .010 INCH (0.025 MM)**

**SERIES 172**  
**OUTLINE DIMENSIONS**

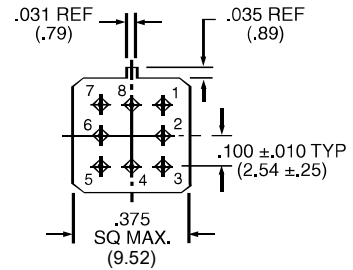
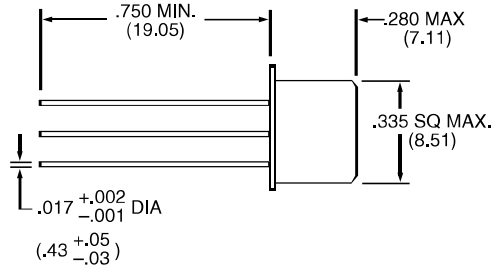

(Viewed From Terminals)

**SCHEMATIC DIAGRAMS**

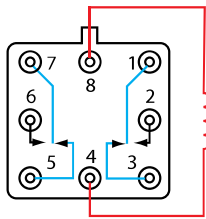

172

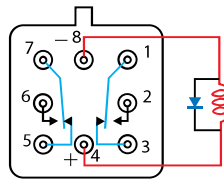

172D

**NOTES:**

1. RELAY CONTACTS WILL EXHIBIT NO CHATTER IN EXCESS OF 10 MSEC OR TRANSFER IN EXCESS OF 1 MSEC.
2. "TYPICAL" CHARACTERISTICS ARE BASED ON AVAILABLE DATA AND ARE BEST ESTIMATES. NO ON-GOING VERIFICATION TESTS ARE PERFORMED.
3. UNLESS OTHERWISE SPECIFIED, PARAMETERS ARE INITIAL VALUES.
4. RELAYS CAN BE SUPPLIED WITH A SPACER PAD. SEE APPENDIX.

## APPENDIX A : Spacer Pads

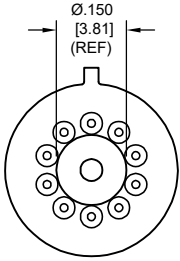
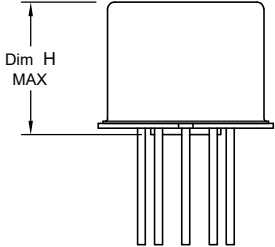
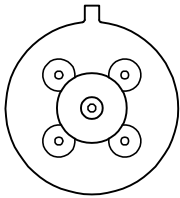
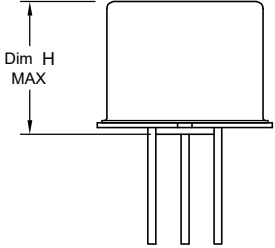
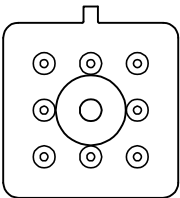
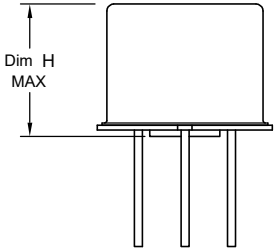
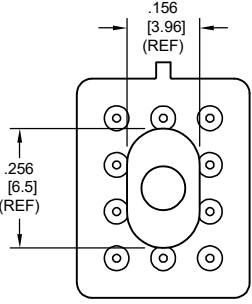
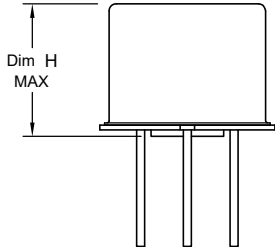
Pad designation and bottom view dimensions	Height	For use with the following:	Dim. H Max.
 <p style="text-align: center;">“M4” Pad for TO-5</p>		ER412	.295 (7.49)
		712, RF300, RF, RF700, RF703	.300 (7.62)
		ER422, 722	.305 (7.75)
		ER432	.400 (10.16)
		732, RF303	.410 (10.41)
		RF312	.350 (8.89)
 <p style="text-align: center;">“M4” Pad for TO-5</p>		ER411	.295 (7.49)
		RF311	.300 (7.62)
		RF331	.410 (10.41)
 <p style="text-align: center;">“M4” Pad for Centgrid®</p>		172	.305 (7.75)
		ER114, J114	.300 (7.62)
		ER134, J134	.400 (10.16)
		RF100	.315 (8.00)
		RF103	.420 (10.67)
 <p style="text-align: center;">“M9” Pad for Centgrid®</p>		122C, A152	.320 (8.13)
		ER116C, J116C	.300 (7.62)
		ER136C, J136C	.400 (10.16)
		RF180	.325 (8.25)
		A150	.305 (7.75)

**Notes:**

1. Spacer pad material: Polyester film.
2. To specify an “M4” or “M9” spacer pad, refer to the mounting variants portion of the part numbering example in the applicable datasheet.
3. Dimensions are in inches (mm).
4. Unless otherwise specified, tolerance is  $\pm .010$ " (.25 mm).
5. Add 10 m $\Omega$  to the contact resistance shown in the datasheet.
6. Add 0.01 oz. (0.25 g) to the weight of the relay assembly shown in the datasheet.

## APPENDIX A : Spreader Pads

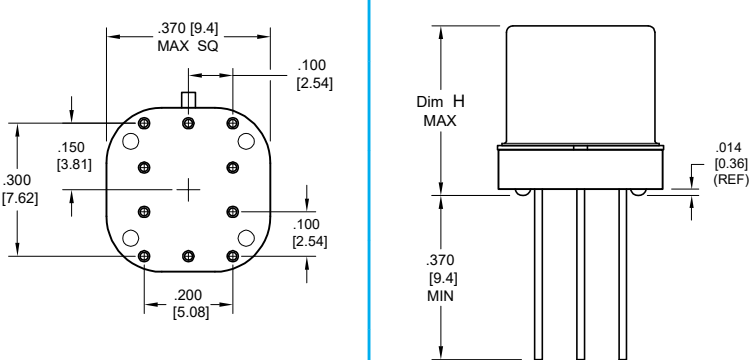
Pad designation and bottom view dimensions	Height	For use with the following:	Dim. H Max.
 <p style="text-align: center;">"M" Pad <u>5</u>/ <u>6</u>/</p>		ER411T, ER412, J412	.388 (9.86)
		712	.393 (9.99)
		ER432, J432	.493 (12.52)
		732	.503 (12.78)
		J421, J422, ER422, 722	.398 (10.11)

**Notes:**

1. Spreader pad material: Diallyl Phthalate.
2. To specify an "M", "M2" or "M3" spreader pad, refer to the mounting variants portion of the part number example in the applicable datasheet.
3. Dimensions are in inches (mm).
4. Unless otherwise specified, tolerance is  $\pm .010$ " (0.25 mm).
- 5/. Add 25 m $\Omega$  to the contact resistance shown in the datasheet.
- 6/. Add .01 oz. (0.25 g) to the weight of the relay assembly shown in the datasheet.
- 7/. Add 50 m $\Omega$  to the contact resistance shown in the datasheet.
- 8/. Add 0.025 oz (0.71 g) to the weight of the relay assembly shown in the datasheet.
- 9/. M3 pad to be used only when the relay has a center pin (e.g. ER411M3-12A, 722XM3-26.)

# APPENDIX A : Ground Pin Positions

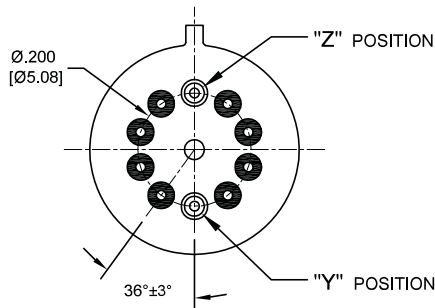

**TO-5 Relays:**  
 ER412, ER412T, ER422, ER432, ER432T, 712,  
 712TN, 400H, 400K, 400V, RF300, RF303, RF341,  
 RF312, RF332, RF310, RF313, RF320, RF323,  
 SI800, SI803, RF700, RF703

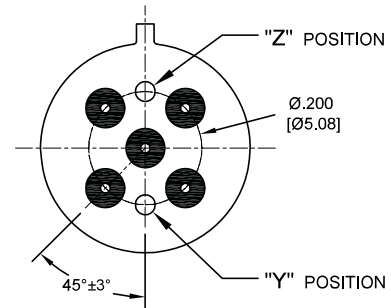

**TO-5 Relays:**  
 ER411, RF311, RF331

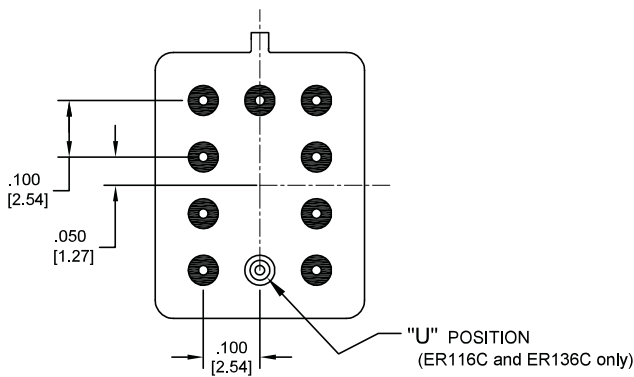

**Centigrad® Relays:**  
 RF180, ER116C, 122C, ER136C

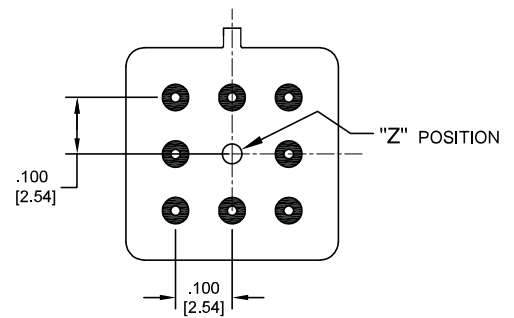

**Centigrad® Relays:**  
 RF100, RF103, ER114, ER134, 172

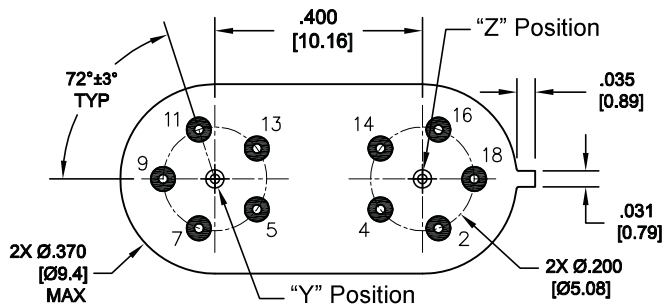

**Loopback Relays:**  
 LB363

- Indicates ground pin position
- Indicates glass insulated lead position
- ◎ Indicates ground pin or lead position depending on relay type

## NOTES

1. Terminal views shown
2. Dimensions are in inches (mm)
3. Tolerances:  $\pm .010$  ( $\pm .25$ ) unless otherwise specified
4. Ground pin positions are within  $.015$  ( $0.38$ ) dia. of true position
5. Ground pin head dia.,  $0.035$  ( $0.89$ ) ref: height  $0.010$  ( $0.25$ ) ref.
6. Lead dia.  $0.017$  ( $0.43$ ) nom.

## X-ON Electronics

Largest Supplier of Electrical and Electronic Components

*Click to view similar products for [General Purpose Relays](#) category:*

*Click to view products by [Teledyne](#) manufacturer:*

Other Similar products are found below :

[APF30318](#) [JVN1AF-4.5V-F](#) [PCN-105D3MHZ](#) [5JO-10000S-SIL](#) [5JO-1000CD-SIL](#) [5JO-400CD-SIL](#) [LY2S-AC220/240](#) [LYQ20DC12](#)  
[6031007G](#) [6131406HQ](#) [6-1393099-8](#) [6-1393122-4](#) [6-1393123-2](#) [6-1393767-1](#) [6-1393843-7](#) [6-1415012-1](#) [6-1419102-2](#) [6-1423698-4](#) [6-](#)  
[1608051-6](#) [6-1608067-0](#) [6-1616170-6](#) [6-1616248-2](#) [6-1616282-3](#) [6-1616348-2](#) [6-1616349-9](#) [6-1616350-1](#) [6-1616350-8](#) [6-1616358-7](#) [6-](#)  
[1616359-9](#) [6-1616360-9](#) [6-1616931-6](#) [6-1617039-1](#) [6-1617052-1](#) [6-1617090-2](#) [6-1617090-5](#) [6-1617347-5](#) [6-1617353-3](#) [6-1617801-8](#) [6-](#)  
[1618107-9](#) [6-1618248-4](#) [CX-4014](#) [MAHC-5494](#) [MAVCD-5419-6](#) [703XCX-120A](#) [7-1393100-5](#) [7-1393111-7](#) [7-1393767-8](#) [7-1414968-8](#) [7-](#)  
[1419130-3](#) [7-1608047-2](#)