



ULTRAMINIATURE BROADBAND ATTENUATOR RELAYS



SERIES	RELAY TYPE
A150	Attenuator Relay series, DC- 3 GHz

DESCRIPTION

The Series A150 ultraminiature Attenuator Relays are designed for attenuating RF signals in 50-ohm systems over a frequency range from DC to 3 GHz. Their low profile and small grid spacing makes them ideal for use when packaging density is a prime consideration. The A150 relays eliminate the need for additional external resistors.

These single section, switchable attenuator relays have internal matched thin film attenuator pads in “L,” “T” or “Pi” configurations, as applicable. Relays are available in fixed increments of 1, 2, 3, 4, 5, 6, 8, 10, 16 and 20 dB, which

can be used singly or in combination to achieve the attenuation levels desired.

The A150 feature:

- Unique uni-frame motor design which provides high magnetic efficiency and mechanical rigidity.
- Minimum mass components and welded construction for maximum resistance to shock and vibration.
- Advanced cleaning techniques which assures internal cleanliness.
- Gold plated, precious metal contacts, which provide excellent intermodulation performance.
- Flat amplitude vs. frequency response.
- High isolation between control and signal path.
- Stable attenuation vs. temperature.
- Excellent phase linearity.
- Highly resistant to ESD.

Patent No. 5,315,273

Part Numbering System

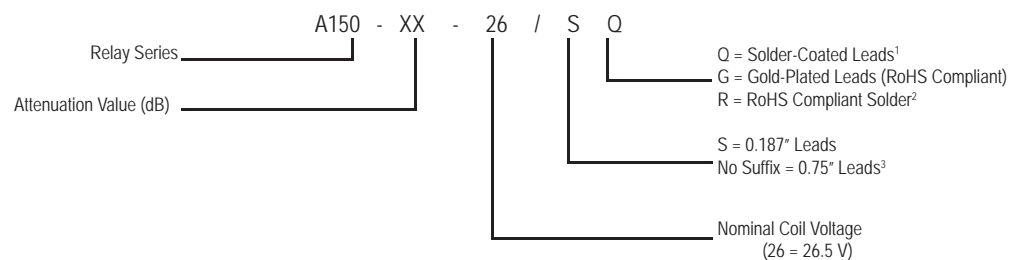

Note: Parts ordered without suffix may be supplied with Solder-Coated or Gold-Plated leads.

1 Parts ordered with Solder-Coated leads will have (Sn60/Pb40)

2 Parts ordered with RoHS Solder-Coated leads will have (Sn99.3/Cu0.7)

ENVIRONMENTAL AND PHYSICAL SPECIFICATIONS

Temperature (Ambient)	-65°C to +125°C
Vibration (General Note I)	10 g's to 2000 Hz
Shock (General Note I)	30 g's, 6ms half sine
Enclosure	Hermetically sealed
Weight	0.11 oz. (3.12g) max.

INTERNAL CONSTRUCTION

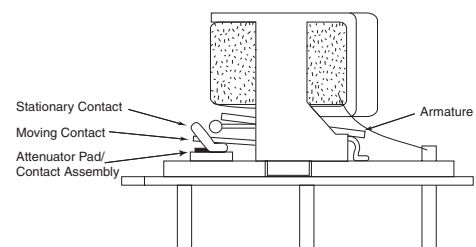

**SERIES A150
GENERAL ELECTRICAL SPECIFICATIONS (@25°C)**

Contact Life Ratings	10,000,000 cycles (typical) at low level	
Operate Time (Note 8)	Max.	4.0 msec max. at nominal rated coil voltage
	Typ.	2.0 msec max. at nominal rated coil voltage
Insulation Resistance	1,000 MΩ min. between mutually isolated terminals	
Dielectric Strength	350 Vrms (60 Hz) @ atmospheric pressure	

DETAILED ELECTRICAL SPECIFICATIONS (@25°C)

BASE PART NUMBERS (A150)		A150-dB-5	A150-dB-12	A150-dB-15	A150-dB-26
Coil Voltage (Vdc)	Nom.	5.0	12.0	15	26.5
	Max.	6.0	16.0	20.0	32.0
Coil Resistance (Ohms ±20%)		50	390	610	1,560
Pick-Up Voltage (Vdc, Max.)		3.8	9.0	11.3	18.0

GENERAL PERFORMANCE (-55°C to +85°C)

PARAMETER	MINIMUM	TYPICAL	MAXIMUM
Operating Frequency (GHz)	0.0	-	3.0
Power (W) (Notes 5 and 6)	-	-	1.0
Impedance (Ω)	-	50	-

TYPICAL RF CHARACTERISTICS

1 dB ATTENUATOR

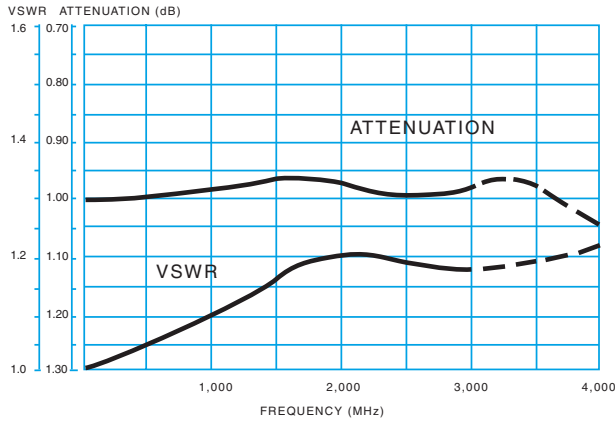

2 dB ATTENUATOR

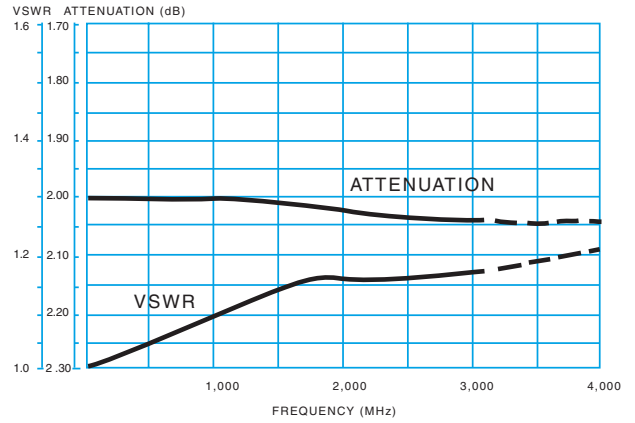

3 dB ATTENUATOR

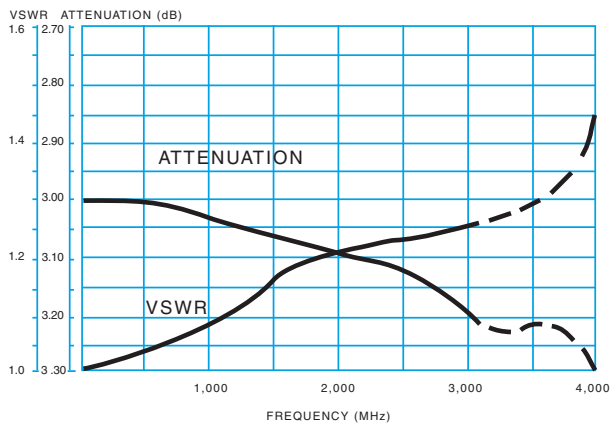

4 dB ATTENUATOR

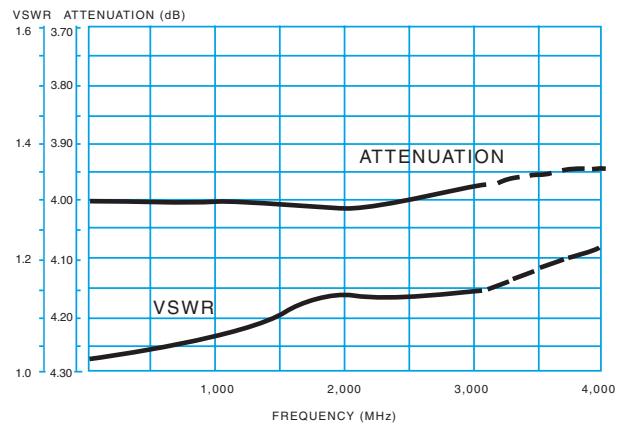

5 dB ATTENUATOR

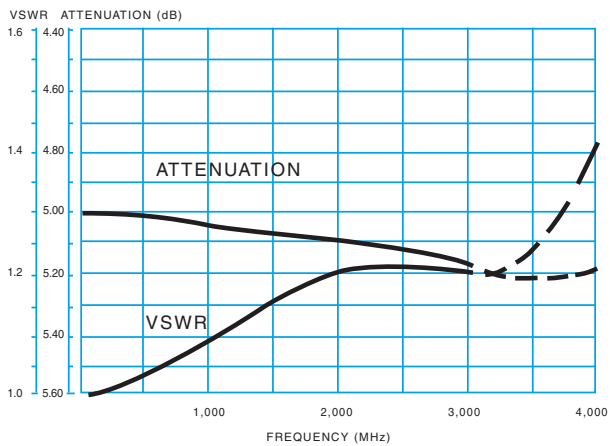

6 dB ATTENUATOR

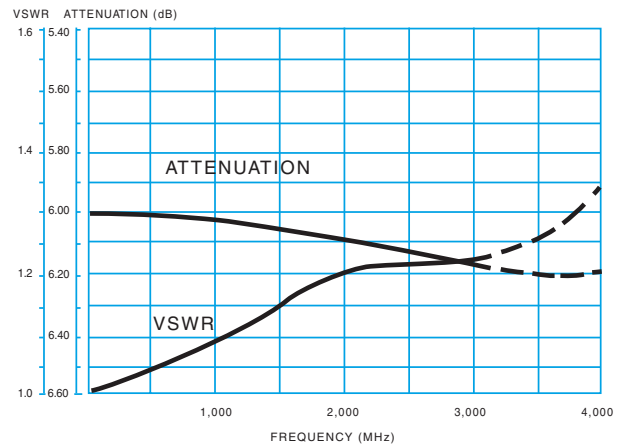

TYPICAL RF CHARACTERISTICS

8 dB ATTENUATOR

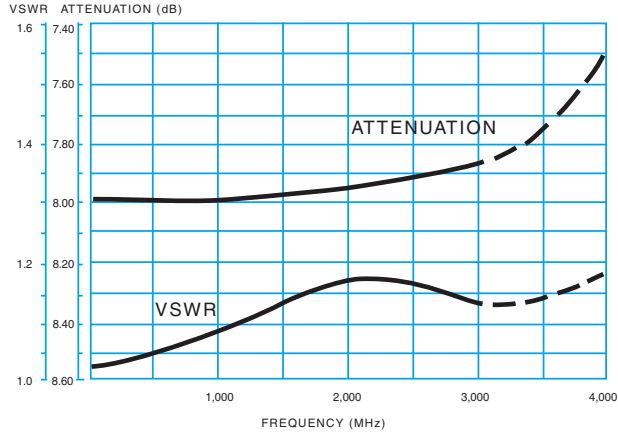

10 dB ATTENUATOR

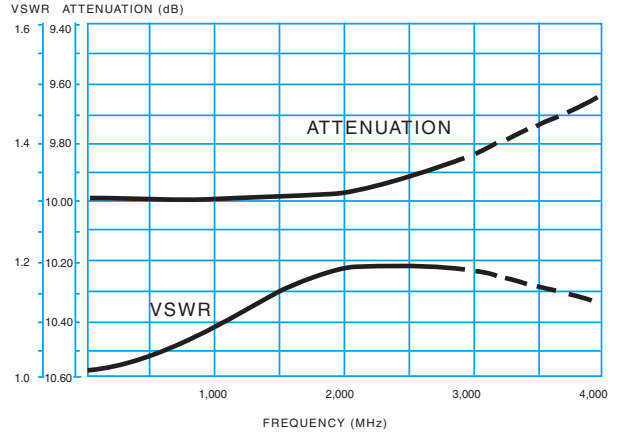

16 dB ATTENUATOR

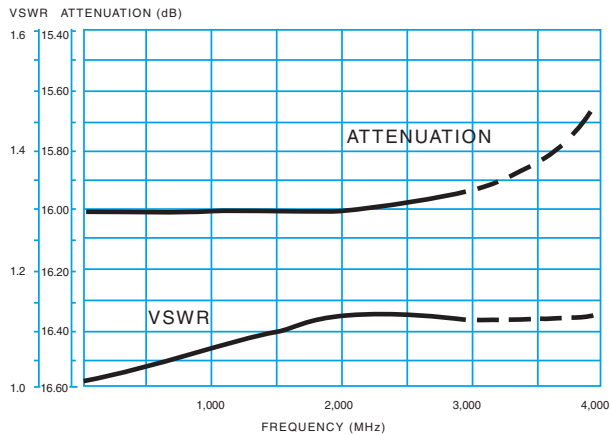

20 dB ATTENUATOR

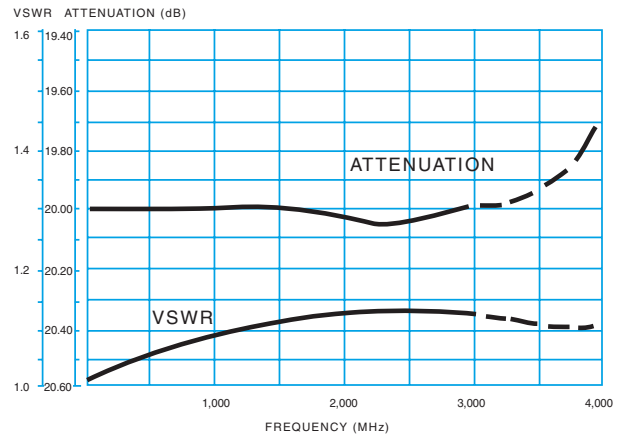

THROUGH PATH

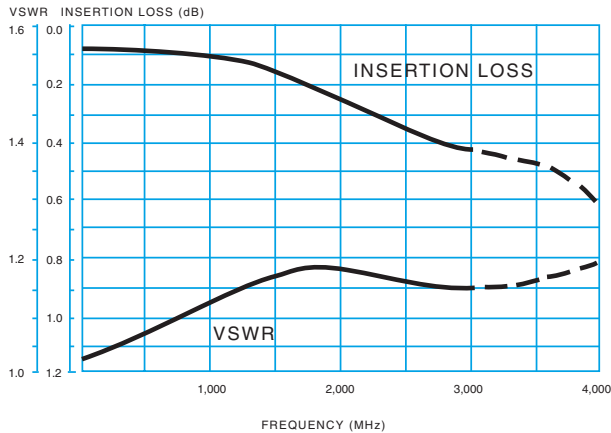

SERIES A150
RF Performance (-55°C to +85°C)

BASE PART NUMBERS (RF180)	RANGE	TYPICAL	MAXIMUM
Insertion Loss (dB)	DC - 1 GHz	0.1	0.25
	1 - 2 GHz	0.2	0.35
	2 - 3 GHz	0.3	0.055
VSWR (Through Path)	DC - 1 GHz	1.10	1.20
	1 - 2 GHz	1.20	1.25
	2 - 3 GHz	1.25	1.30
VSWR (Attenuated Path)	DC - 1 GHz	1.20	1.25
	1 - 2 GHz	1.30	1.35
	2 - 3 GHz	1.40	1.45

ATTENUATION (dB)	RANGE	MINIMUM	TYPICAL	MAXIMUM
1	DC - 1 GHz	0.95	1.0	1.05
	1 - 2 GHz	0.925	1.0	1.075
	2 - 3 GHz	0.875	1.0	1.125
2	DC - 1 GHz	1.9	2.0	2.15
	1 - 2 GHz	1.85	2.0	2.15
	2 - 3 GHz	1.75	2.0	2.25
3	DC - 1 GHz	2.85	3.0	3.15
	1 - 2 GHz	2.77	3.0	3.23
	2 - 3 GHz	2.62	3.0	3.38
4	DC - 1 GHz	3.8	4.0	4.2
	1 - 2 GHz	3.7	4.0	4.3
	2 - 3 GHz	3.5	4.0	4.5
5	DC - 1 GHz	4.75	5.0	5.25
	1 - 2 GHz	4.62	5.0	5.38
	2 - 3 GHz	4.37	5.0	5.63
6	DC - 1 GHz	5.7	6.0	6.3
	1 - 2 GHz	5.55	6.0	6.45
	2 - 3 GHz	5.25	6.0	6.75
8	DC - 1 GHz	7.88	8.0	8.12
	1 - 2 GHz	7.76	8.0	8.24
	2 - 3 GHz	7.52	8.0	8.48
10	DC - 1 GHz	9.85	10.0	10.15
	1 - 2 GHz	9.7	10.0	10.3
	2 - 3 GHz	9.4	10.0	10.6
16	DC - 1 GHz	15.76	16.0	16.25
	1 - 2 GHz	15.52	16.0	16.48
	2 - 3 GHz	15.04	16.0	16.96
20	DC - 1 GHz	19.8	20.0	20.2
	1 - 2 GHz	19.6	20.0	20.4
	2 - 3 GHz	19.0	20.0	21.0

SERIES A150 OUTLINE DIMENSIONS

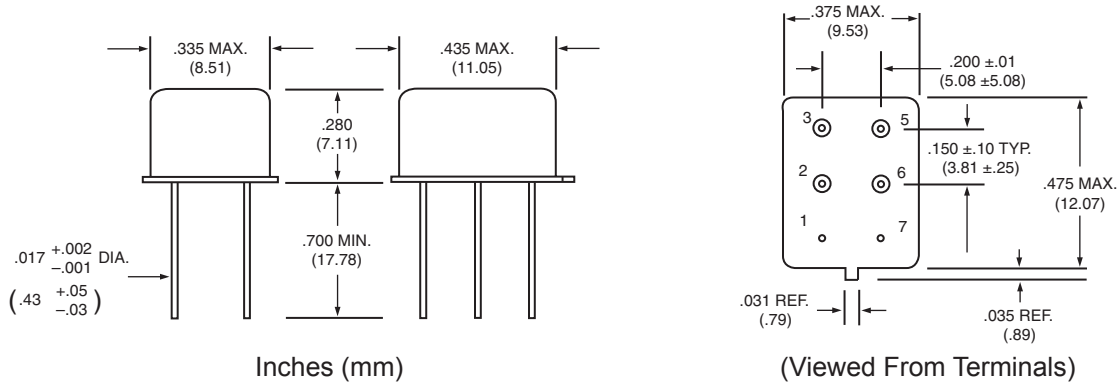

A150 SCHEMATIC DIAGRAMS

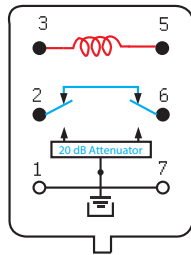

NOTES:

1. Contacts will exhibit no contact chatter in excess of 10 μ s or transfer in excess of 1 μ s.
2. Relays may be operated at higher frequencies with reduced RF performance.
3. For optimal RF performance, solder case to RF ground plane.
4. Attenuation values shown are with reference to the through path (low loss state).
5. Power handling for case temperatures of -55°C to $+55^{\circ}\text{C}$ is 1 Watt. Derate power handling 25 $\text{mW}/^{\circ}\text{C}$ above $+55^{\circ}\text{C}$. Case measurement point is adjacent to the relay tab.
6. Do not operate coil at maximum coil voltage continuously.
7. Insert attenuation value, see part numbering system.
8. Switching time includes bounce.
9. The slash and characters appearing after the slash are not marked on the relay.
10. Unless otherwise specified, relays will be supplied with either gold-plated or solder-coated leads.

APPENDIX A : Spacer Pads

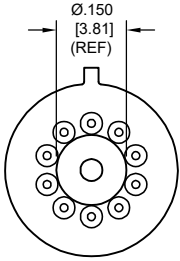
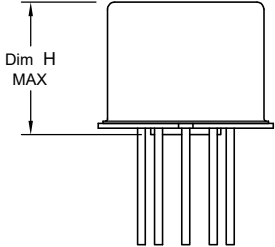
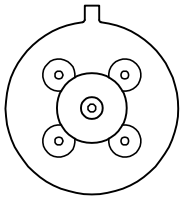
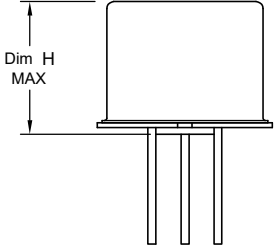
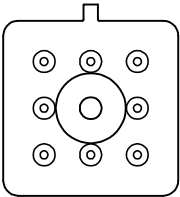
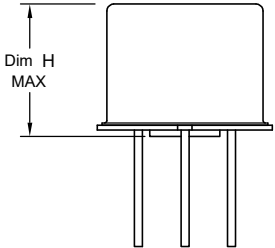
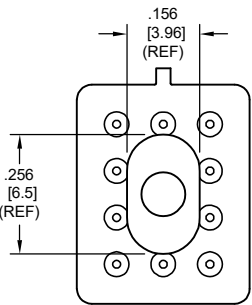
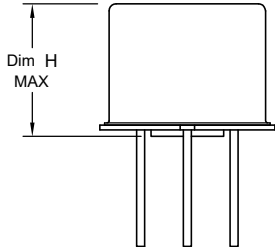
Pad designation and bottom view dimensions	Height	For use with the following:	Dim. H Max.
 <p style="text-align: center;">"M4" Spacer Pad for TO-5</p>		ER412	.295 (7.49)
		712, RF300, RF, RF700, RF703	.300 (7.62)
		ER422, 722	.305 (7.75)
		ER432	.400 (10.16)
		732, RF303	.410 (10.41)
		RF312	.350 (8.89)
 <p style="text-align: center;">"M4" Spacer Pad for TO-5</p>		ER411	.295 (7.49)
		RF311	.300 (7.62)
		RF331	.410 (10.41)
 <p style="text-align: center;">"M4" Spacer Pad for Centigrid®</p>		172	.305 (7.75)
		ER114, J114	.300 (7.62)
		ER134, J134	.400 (10.16)
		RF100	.315 (8.00)
		RF103	.420 (10.67)
 <p style="text-align: center;">"M9" Spacer Pad for Centigrid®</p>		122C, A152	.320 (8.13)
		ER116C, J116C	.300 (7.62)
		ER136C, J136C	.400 (10.16)
		RF180	.325 (8.25)
		A150	.305 (7.75)

Notes:

1. Spacer pad material: Polyester film.
2. To specify an "M4" or "M9" spacer pad, refer to the mounting variants portion of the part numbering example in the applicable datasheet.
3. Dimensions are in inches (mm).
4. Unless otherwise specified, tolerance is $\pm .010$ " (.25 mm).
5. Add 10 m Ω to the contact resistance shown in the datasheet.
6. Add 0.01 oz. (0.25 g) to the weight of the relay assembly shown in the datasheet.

APPENDIX A : Spreader Pads

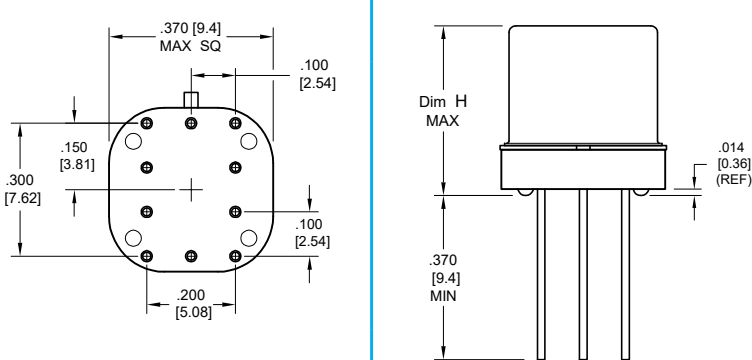
Pad designation and bottom view dimensions	Height	For use with the following:	Dim. H Max.
 <p style="text-align: center;">"M" Spreader Pad <u>5/</u> <u>6/</u></p>		ER411T, ER412, J412	.388 (9.86)
		712	.393 (9.99)
		ER432, J432	.493 (12.52)
		732	.503 (12.78)
		J421, J422, ER422, 722	.398 (10.11)

Notes:

1. Spreader pad material: Diallyl Phthalate.
2. To specify an "M", "M2" or "M3" spreader pad, refer to the mounting variants portion of the part number example in the applicable datasheet.
3. Dimensions are in inches (mm).
4. Unless otherwise specified, tolerance is $\pm .010$ " (0.25 mm).
- 5/. Add 25 m Ω to the contact resistance shown in the datasheet.
- 6/. Add .01 oz. (0.25 g) to the weight of the relay assembly shown in the datasheet.
- 7/. Add 50 m Ω to the contact resistance shown in the datasheet.
- 8/. Add 0.025 oz (0.71 g) to the weight of the relay assembly shown in the datasheet.
- 9/. M3 pad to be used only when the relay has a center pin (e.g. ER411M3-12A, 722XM3-26.)

APPENDIX A : Ground Pin Positions

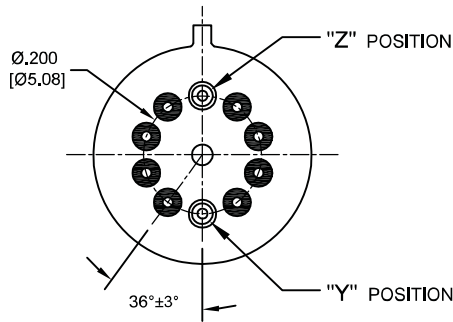

TO-5 Relays:

ER412, ER412T, ER422, ER432, ER432T, 712, 712TN, 400H, 400K, 400V, RF300, RF303, RF341, RF312, RF332, RF310, RF313, RF320, RF323, SI800, SI803, RF700, RF703

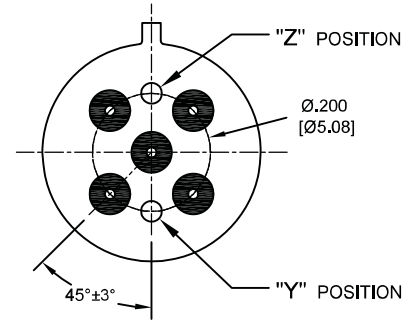

TO-5 Relays:

ER411, RF311, RF331

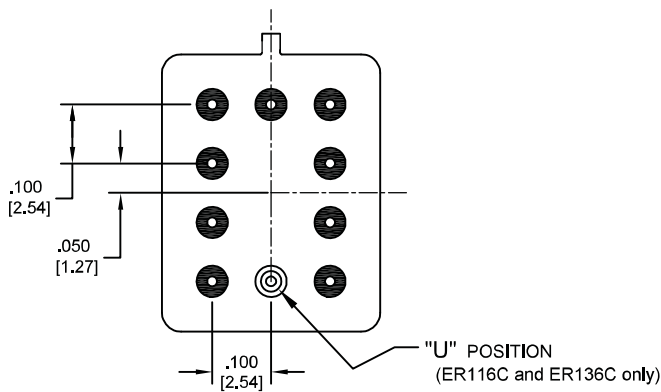

Centigrid® Relays:

RF180, ER116C, 122C, ER136C

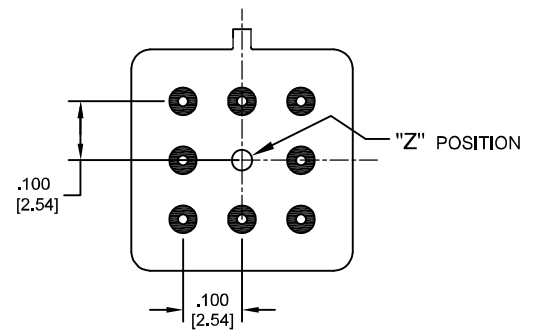

Centigrid® Relays:

RF100, RF103, ER114, ER134, 172

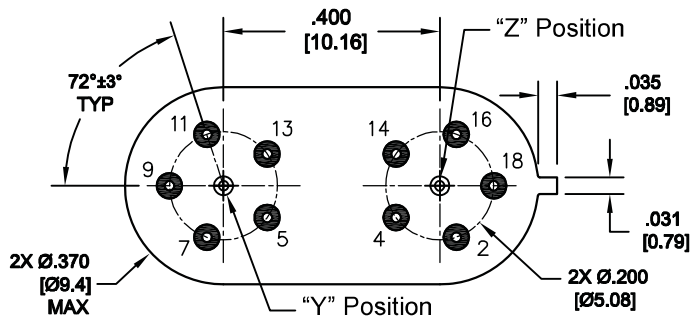

Loopback Relays:

LB363

NOTES

- Indicates ground pin position
- Indicates glass insulated lead position
- ◎ Indicates ground pin or lead position depending on relay type

1. Terminal views shown
2. Dimensions are in inches (mm)
3. Tolerances: $\pm .010$ ($\pm .25$) unless otherwise specified
4. Ground pin positions are within $.015$ (0.38) dia. of true position
5. Ground pin head dia., 0.035 (0.89) ref: height 0.010 (0.25) ref.
6. Lead dia. 0.017 (0.43) nom.

X-ON Electronics

Largest Supplier of Electrical and Electronic Components

Click to view similar products for [General Purpose Relays](#) category:

Click to view products by [Teledyne](#) manufacturer:

Other Similar products are found below :

[PCN-105D3MH,000](#) [59641F200](#) [5JO-1000CD-SIL](#) [5X827E](#) [5X837F](#) [5X840F](#) [5X842F](#) [5X848E](#) [LY2N-AC120](#) [LY2S-AC220/240](#) [LY2-US-AC120](#) [LY2-US-DC24](#) [LY3-US-AC120](#) [LY4F-UA-DC12](#) [LY4F-UA-DC24](#) [LY4F-US-AC120](#) [LY4F-US-AC240](#) [LY4F-US-DC24](#) [LY4F-VD-AC110](#) [LYQ20DC12](#) [M115C60](#) [M115N010](#) [M115N0150](#) [603-12D](#) [60HE1-5DC](#) [60HE2S-12DC](#) [61211T0B4](#) [61212T400](#) [61222Q400](#) [61243B600](#) [61243C500](#) [61243Q400](#) [61311BOA2](#) [61311BOA6](#) [61311BOA8](#) [61311C0A2](#) [61311COA1](#) [61311COA6](#) [61311F0A2](#) [61311QOA1](#) [61311QOA4](#) [61311T0D6](#) [61311TOA6](#) [61311TOA7](#) [61311TOB3](#) [61311TOB4](#) [61311U0A6](#) [61312Q600](#) [61312T400](#) [61312T600](#)