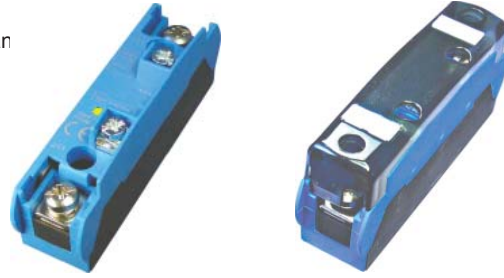


**FEATURES/BENEFITS**

- New High Efficiency Back-to-Back Thyristors for long lifetime expectan
- Zero-cross models designed for resistive loads
- Input protection and control LED standard
- IP20 protective plastic cover
- Designed in conformity with EN60947-4-3 (IEC947-4-3) and EN60950/VDE0805 (Reinforced Insulation)



Part No.	Load Voltage	Load Current	Control Voltage	Switch Type
DH24D25	12-280 Vac	25A	3-32 Vdc	Zero Cross
DH48D35	24-600 Vac	35A	3.5-32 Vdc	Zero Cross

**NOTES**

- 1) Line Voltage (nominal): 24 = 240 Vac; 48 = 480 Vac
- 2) Switch Type: D = Zero-cross turn-on

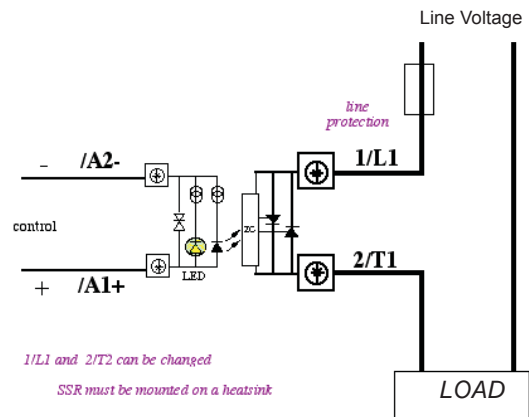
**ELECTRICAL SPECIFICATIONS**

(+25°C ambient temperature unless otherwise specified)

**INPUT (CONTROL) SPECIFICATIONS**

	Min	Max	Units
<b>Input Voltage Range</b>			
DH24	3	32	V
DH48	3.5	32	V
<b>Input Current Range</b>			
All Relays		14	mA
Must Turn-Off Voltage	2.0		Vdc
Reverse Voltage Protection (D)		32	V
Clamping Voltage (D)		36	V
Input Immunity (EN61000-4-4)		2	kV
Input Immunity (EN61000-4-5)		2	kV

**TYPICAL APPLICATION**



**CONTROL CHARACTERISTICS**

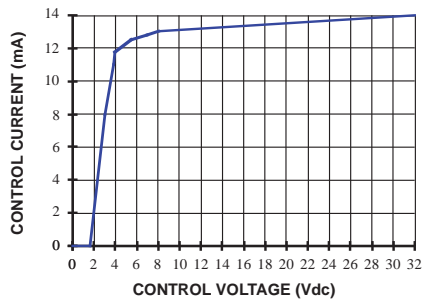


Figure 1

**ELECTRICAL SPECIFICATIONS**  
(+25°C ambient temperature unless otherwise specified)

**OUTPUT (LOAD) SPECIFICATIONS**

	Min	Max	Units
Operating Range			
DH24	12	280	Vac
DH48	12	600	Vac
Peak Voltage (VDR Clamping)			
DH24		600	V <sub>peak</sub>
DH48		1200	V <sub>peak</sub>
Load Current Range (Resistive)			
25 output current	.005	25	Arms
35 output current	.005	35	Arms
Maximum Surge Current Rating (Non-Repetitive)			
25 output current		250	A
35 output current		420	A
On-State Voltage Drop		0.85	V
Output Power Dissipation (Max)			
25 output current	$0.9 \times 0.85 \times I + 0.016 \times I^2$		W
35 output current	$0.9 \times 0.85 \times I + 0.0095 \times I^2$		W
Zero-Cross Window (Typical)		±20	Vac
Off-State Leakage Current		1	mA
Turn-On Time (60 Hz)		8.3	ms
Turn-Off Time (60 Hz)		8.3	ms

**ELECTRICAL SPECIFICATIONS (continued)**  
(+25°C ambient temperature unless otherwise specified)

**OUTPUT (LOAD) SPECIFICATIONS**

	Min	Max	Units
Off-State dv/dt		500	V/μs
Maximum di/dt (Non-Repetitive)		50	A/μs
Operating Frequency	0.1	800	Hz
I <sup>2</sup> t for fuse matching (<10ms)			
25 output current		340	A <sup>2</sup> s
35 output current		882	A <sup>2</sup> s
Junction-Case Thermal Resistance			
25 output current		1.8	°C/W
35 output current		0.9	°C/W
Conducted Immunity Level			
IEC/EN61000-4-4 (bursts)			
All Relays		2kV criterion A	
IEC/EN61000-4-5 (surge)			
All Relays		2kV criterion B	
		2kV criterion A on -16 models	

**GENERAL SPECIFICATIONS**  
(+25°C ambient temperature unless otherwise specified)

ENVIRONMENTAL SPECIFICATIONS			
	Min	Max	Units
Operating Temperature	-40	+80	°C
Storage Temperature	-55	+125	°C
Ambient Humidity		40 to 85	%
Input-Output Isolation	4000		Vrms

Output-Case Isolation	4000	Vrms
Insulation Resistance @500Vdc	1000	MΩ
Rated Impulse Voltage	4000	V
Vibration (10–55 Hz according to CE168)	1.5	mm
Shock (according to CD168)	30	g
Housing Material	PA6 UL94V0	
Baseplate	Aluminum	

**MECHANICAL SPECIFICATION**

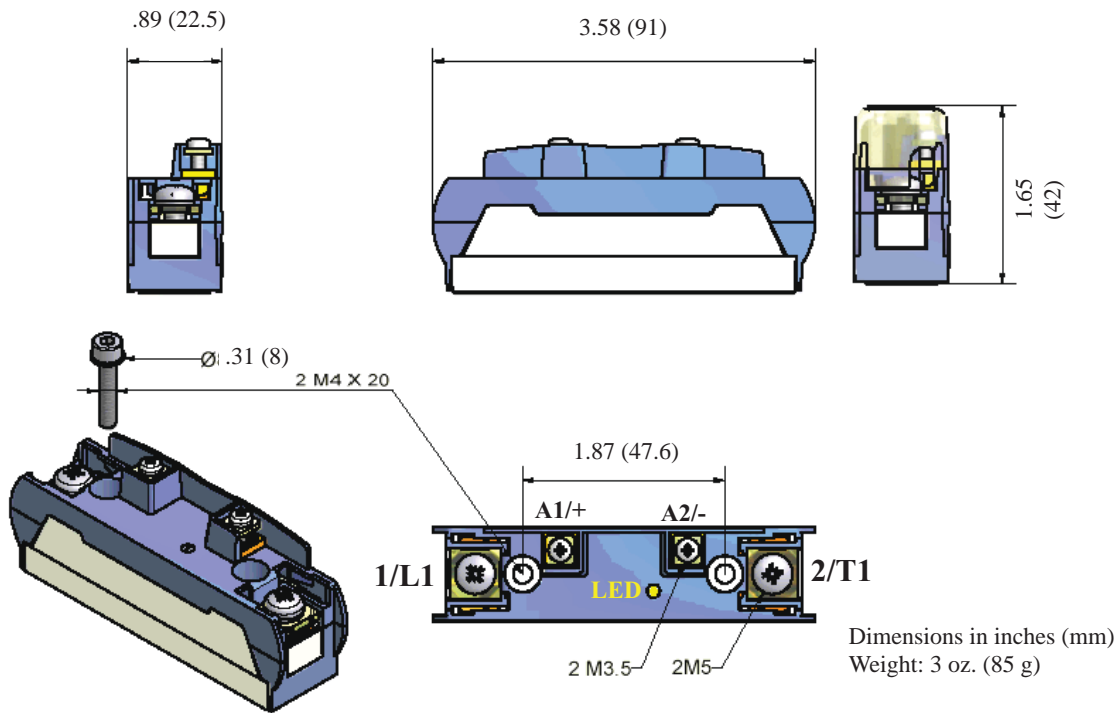


Figure 3

**SURGE CURRENT**

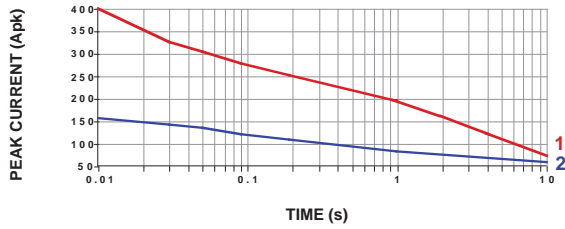


Figure 4c — 35A output current

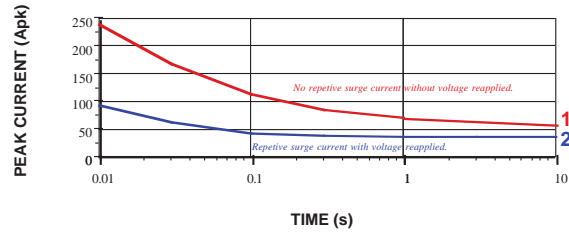


Figure 4b — 25A output current

**THERMAL CURVES**

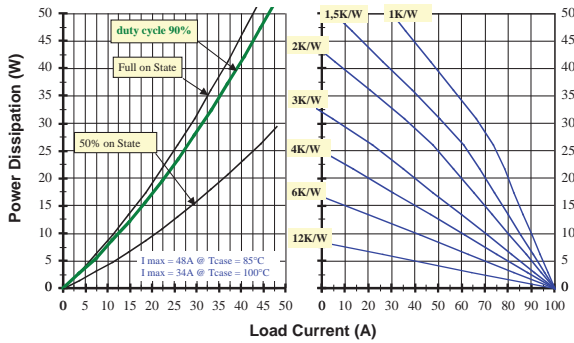


Figure 5c — 35A output power

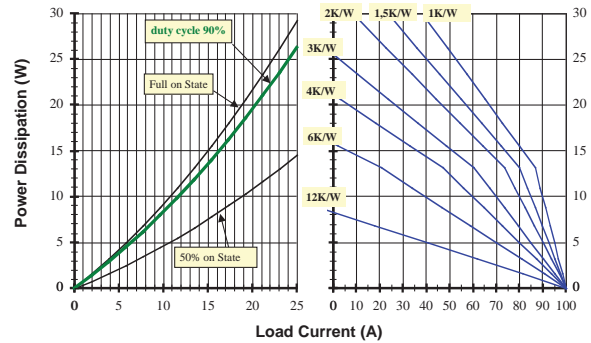
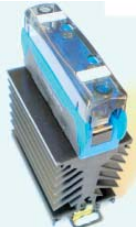
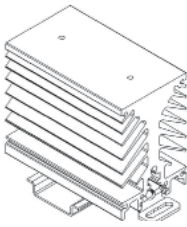

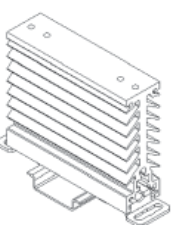
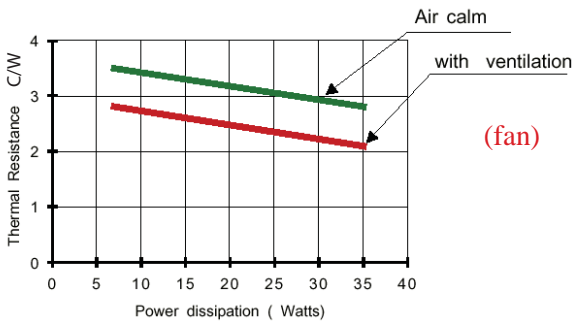


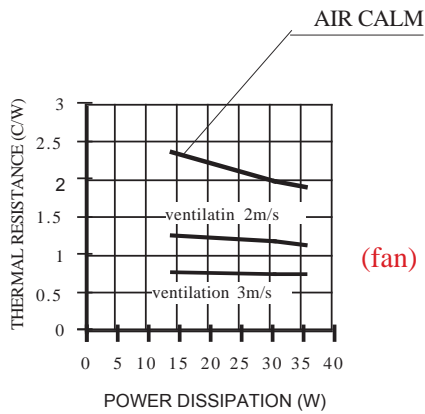
Figure 5b — 25A output power

12°C/W corresponds to a relay without heat sink  
6°C/W corresponds to a relay mounted on a DIN-rail adaptor (Teledyne P/N DL12)

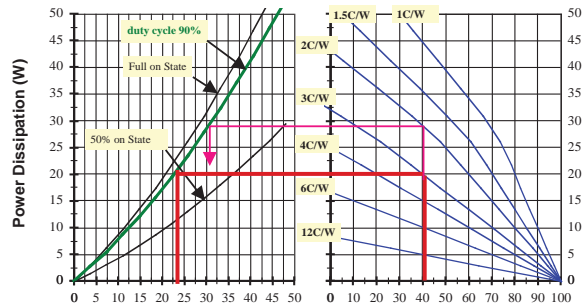
HEAT MANAGEMENT			
Number of Wires			
FW151		FW031	
2-2.5 °C/W Heatsink		3 °C/W Heatsink	
			



**Figure 6a**

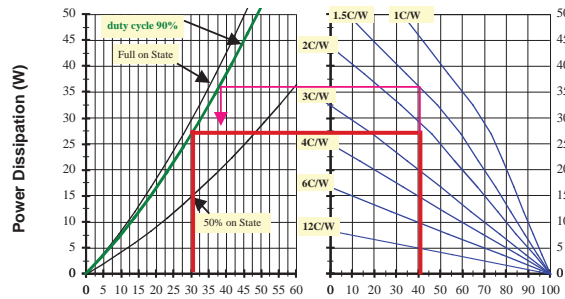


**Figure 6b**



**Figure 7b - Load Current (25A Model)**


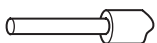

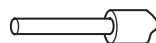

Example 1: 18A @ 40 °C, Recommended Heatsink: 3 °C/W  
 Example 2: 22A @ 40 °C, Recommended Heatsink: 2 °C/W

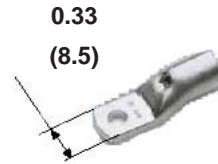


**Figure 7c - Load Current (35A Model)**


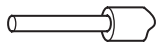
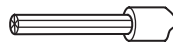
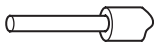
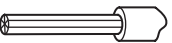
Example 1: 30A @ 40 °C, Recommended Heatsink: 1.5 °C/W  
 Example 2: 38A @ 40 °C, Recommended Heatsink: 2.2 °C/W

**CONTROL WIRING**

Number of Wires				Screwdriver Type	Recommended Torque
1		2			
Solid (no ferrule)	Fine Stranded (with ferrule)	Solid (no ferrule)	Fine Stranded (with ferrule)		N.m
					
AWG18...AWG14	AWG18...AWG14	AWG18...AWG14	AWG18...AWG14		



**POWER WIRING**

Number of Wires				Screwdriver Type	Recommended Torque
1		2			
Solid (no ferrule)	Fine Stranded (with ferrule)	Solid (no ferrule)	Fine Stranded (with ferrule)		N.m
					
AWG16...AWG8	AWG16...AWG10	AWG16...AWG8	AWG16...AWG10		

## X-ON Electronics

Largest Supplier of Electrical and Electronic Components

*Click to view similar products for [Solid State Relays - Industrial Mount](#) category:*

*Click to view products by [Teledyne](#) manufacturer:*

Other Similar products are found below :

[D2440-C](#) [H10CA4890](#) [D4875C](#) [D53TP50DH-10](#) [1395831-1](#) [1616010-6](#) [BR312BY](#) [A-1326](#) [H10CA4850](#) [H12CA4890VL](#) [RA2410-D06](#)  
[RA2410HA06T](#) [D1202F](#) [D53TP50-10](#) [W230E-1-12](#) [W230T-3-12](#) [1-1617030-3](#) [1-1617033-7](#) [MS2-D2420](#) [MS2-D2430](#) [A-1440](#)  
[RJ1P60V50E](#) [HS501DR-D2425](#) [RN1F48I50](#) [70.362.1028.0](#) [7-1393030-8](#) [Z5.509.0828.0](#) [G3DZ-4B DC24](#) [G3DZ-F4B DC12](#) [SSRDAC10](#)  
[RV8S-L-A240-D24](#) [RV8S-L-A240-D6](#) [RV8S-S-A240-D24](#) [RV8S-S-A240-D6](#) [RV8S-S-A240Z-D24](#) [RV8S-S-D24-A240](#) [RV8S-S-D48-A120](#)  
[RN1F12V50](#) [RJ1P60I30E](#) [RJ1P60V30E](#) [SO967860](#) [SMT8628521](#) [SO869970](#) [SOD867180](#) [SAL961360](#) [SO867970](#) [SOB863860](#)  
[SOB867640](#) [SOB942360](#) [G3PH-5150B DC5-24](#)