

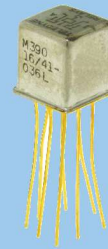

CENTIGRID®
ESTABLISHED RELIABILITY
MILITARY
DPDT



SERIES	RELAY TYPE
114	DPDT basic relay
114D	DPDT relay with internal diode for coil transient suppression
114DD	DPDT relay with internal diodes for coil transient suppression and polarity reversal protection

DESCRIPTION

The 114 sensitive Centigrid® relay retains the same features as the 114 standard Centigrid® relay with only a minimal increase in profile height (.275 in.). Its .100-inch grid spaced terminals, which preclude the need for spreader pads, and its low profile make the 114 relay ideal for applications where high packaging density is important.

The following unique construction features and manufacturing techniques provide excellent resistance to environmental extremes and overall high reliability:

The 114 feature:

- All welded construction.
- Advanced cleaning techniques provide maximum assurance of internal cleanliness.
- Unique uni-frame design providing high magnetic efficiency and mechanical rigidity.

- High force/mass ratios for resistance to shock and vibration.
- Precious metal alloy contact material with gold plating assures excellent high current and dry circuit switching capabilities.

The Series 114D and 114DD have internal discrete silicon diodes for coil suppression and polarity reversal protection.

By virtue of its inherently low intercontact capacitance and contact circuit losses, the 114 relay has proven to be an excellent ultraminiature RF switch for frequency ranges well into the UHF spectrum. A typical RF application for the Centigrid® relay is in handheld radio transceivers, wherein the combined features of good RF performance, small size, low coil power dissipation and high reliability make it a preferred method of Transmit-Receive switching

ENVIRONMENTAL AND PHYSICAL SPECIFICATIONS	
Temperature (Ambient)	-65°C to +125°C
Vibration (General Note I)	30 g's to 3000 Hz
Shock (General Note I)	75 g's, 6ms half sine
Acceleration	50 g's
Enclosure	Hermetically sealed
Weight	0.09 oz. (2.55g) max.

INTERNAL CONSTRUCTION

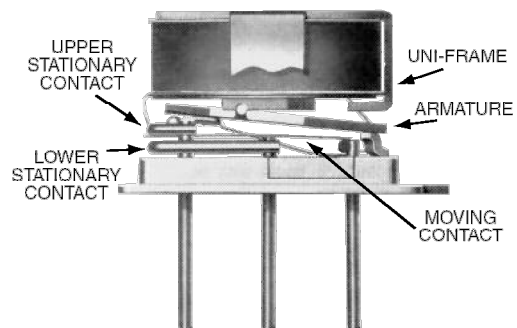

SERIES 114
GENERAL ELECTRICAL SPECIFICATIONS (-65 °C to 125 °C unless otherwise noted. See notes 2 & 3.)

Contact Arrangement	2 Form C (DPDT)	
Rated Duty	Continuous	
Contact Resistance	0.1 ohm max. before life; 0.2 ohm max. after life at 1A/28Vdc	
Contact Load Rating (DC)	Resistive: 1 A / 28 Vdc Inductive: 200 mA / 28 Vdc (320mH) Lamp: 100 mA / 28 Vdc (320mH) Low level: 10 to 50 μ A @ 10 to 50 mV	
Contact Load Rating (AC)	Resistive: 250 mA / 115Vac, 60 and 400 Hz (Case not grounded) 100 mA / 115 Vac, 60 and 400 Hz (Case grounded)	
Contact Life Ratings	10,000,000 cycles (typical) at low level 1,000,000 cycles (typical) at 0.5 A / 28 Vdc resistive 100,000 cycles min. at all other loads specified above	
Contact Overload Rating	2 A / 28 Vdc Resistive (100 cycles min.)	
Contact Carry Rating	Contact Factory	
Operate Time	2.0 msec max. at nominal rated coil voltage	
Release Time	114	1.5 ms max.
	114D	4.0 ms max
	114DD	
Contact Bounce	1.5 msec max.	
Intercontact Capacitance	0.4 pf typical	
Insulation Resistance	10,000 M Ω min. between mutually isolated terminals	
Dielectric Strength (Vrms/60)	Atmospheric pressure: 500 Vrms	70,000 ft: 125
Negative Coil Transient (Vdc)	114D 114DD	1.0 Vdc Max.
Diode P.I.V. (Vdc)	114D 114DD	100 Vdc Min.

PERFORMANCE CURVES (Note 2)



GENERAL NOTES

- Relay contacts will exhibit no chatter in excess of 10 μ sec or transfer in excess of 1 μ sec.
- "Typical" characteristics are based on available data and are best estimates. No on-going verification tests are performed.
- Unless otherwise specified, parameters are initial values.
- Relays can be supplied with a spacer pad. See appendix.

114 Series

DETAILED ELECTRICAL SPECIFICATIONS (-65 °C to 125 °C unless otherwise noted. See note 3.)

BASE PART NUMBERS (114, 114D, 114DD)			114-5 114D-5 114DD-5	114-12 114D-12 114DD-12	114-26 114D-26 114DD-26
Coil Voltage	Nom.		5.0	12.0	26.5
	Max.		5.8	16.0	32.0
Coil Resistance (Ohms ±10% @25°C)	114, 114D		50	390	1560
	114DD		39	390	1560
Coil Current (114DD) (mAdc@25°C)	(Note 5)	Min.	93.2	25.6	14.8
		Max.	128.2	32.8	18.5
Pick-up Voltage (Vdc, Max)	114, 114D		3.5	9.0	18.0
	114DD		4.0	10.0	19.0
Drop-out Voltage (Vdc)	114, 114D	Min.	0.14	0.41	0.89
		Max.	2.3	6.5	13.0
	114DD	Min.	0.6	0.9	1.4
		Max.	2.8	6.5	13.0

NOTES:

- Relay contacts will exhibit no chatter in excess of 10 µsec or transfer in excess of 1 µsec.
- "Typical" characteristics are based on available data and are best estimates. No on-going verification tests are performed.
- Unless otherwise specified, parameters are initial values.
- For reference only. Coil resistance not directly measurable at relay terminals due to internal series semiconductor, 114DD only
- Unless otherwise specified, relays will be supplied with either gold-plated or solder-coated leads.
- The slash and characters appearing after the slash are not marked on the relay.
- Limit Base Emitter current to 15 mAdc.
- Applicable to all coil voltages. See Base current to turn on.
- Screened HI-REL versions available. Contact factory.

**SERIES 114
OUTLINE DIMENSIONS**



Dimensions: in. (mm)

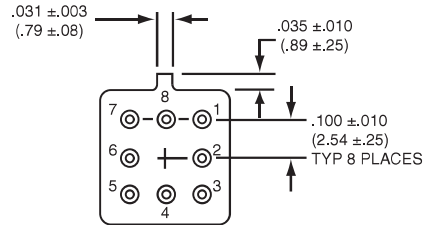

(Viewed From Terminals)

SCHEMATIC DIAGRAMS



114



114D



114DD

Part Numbering System

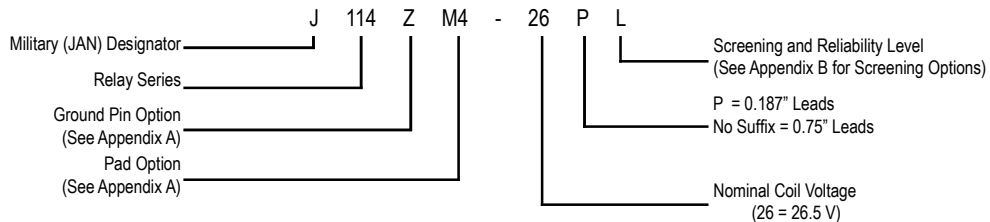
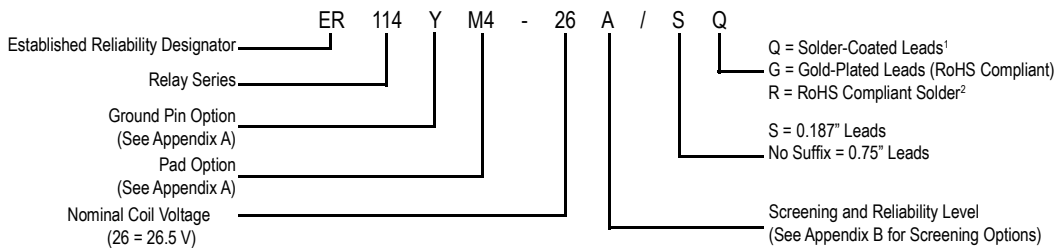

APPENDIX A : Spacer Pads

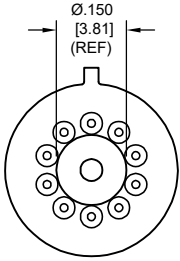
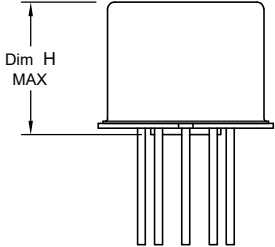
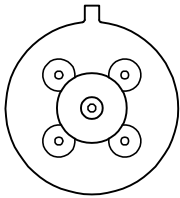
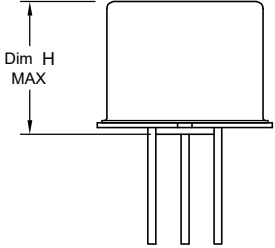
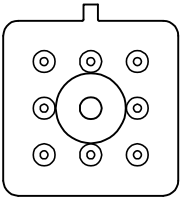
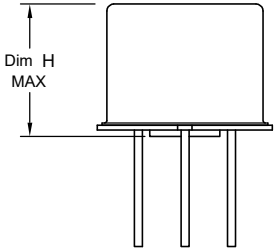
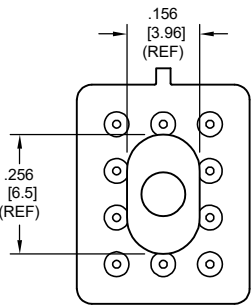
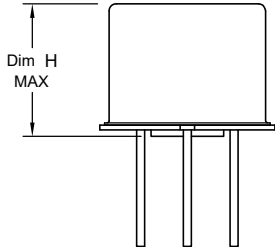
Pad designation and bottom view dimensions	Height	For use with the following:	Dim. H Max.
 <p style="text-align: center;">“M4” Spacer Pad for TO-5</p>		ER412	.295 (7.49)
		712, RF300, RF, RF700, RF703	.300 (7.62)
		ER422, 722	.305 (7.75)
		ER432	.400 (10.16)
		732, RF303	.410 (10.41)
		RF312	.350 (8.89)
 <p style="text-align: center;">“M4”Spacer Pad for TO-5</p>		ER411	.295 (7.49)
		RF311	.300 (7.62)
		RF331	.410 (10.41)
 <p style="text-align: center;">“M4” Spacer Pad for Centigrid®</p>		172	.305 (7.75)
		ER114, J114	.300 (7.62)
		ER134, J134	.400 (10.16)
		RF100	.315 (8.00)
		RF103	.420 (10.67)
 <p style="text-align: center;">“M9”Spacer Pad for Centigrid®</p>		122C, A152	.320 (8.13)
		ER116C, J116C	.300 (7.62)
		ER136C, J136C	.400 (10.16)
		RF180	.325 (8.25)
		A150	.305 (7.75)

Notes:

1. Spacer pad material: Polyester film.
2. To specify an “M4” or “M9” spacer pad, refer to the mounting variants portion of the part numbering example in the applicable datasheet.
3. Dimensions are in inches (mm).
4. Unless otherwise specified, tolerance is $\pm .010$ " (.25 mm).
5. Add 10 m Ω to the contact resistance shown in the datasheet.
6. Add 0.01 oz. (0.25 g) to the weight of the relay assembly shown in the datasheet.

APPENDIX A : Spreader Pads

Pad designation and bottom view dimensions	Height	For use with the following:	Dim. H Max.
<p style="text-align: center;">"M" Spreader Pad <u>5/</u> <u>6/</u></p>		ER411T, ER412, J412	.388 (9.86)
		712	.393 (9.99)
		ER432, J432	.493 (12.52)
		732	.503 (12.78)
		J421, J422, ER422, 722	.398 (10.11)

Notes:

1. Spreader pad material: Diallyl Phthalate.
2. To specify an "M", "M2" or "M3" spreader pad, refer to the mounting variants portion of the part number example in the applicable datasheet.
3. Dimensions are in inches (mm).
4. Unless otherwise specified, tolerance is $\pm .010$ " (0.25 mm).
- 5/. Add 25 m Ω to the contact resistance shown in the datasheet.
- 6/. Add .01 oz. (0.25 g) to the weight of the relay assembly shown in the datasheet.
- 7/. Add 50 m Ω to the contact resistance shown in the datasheet.
- 8/. Add 0.025 oz (0.71 g) to the weight of the relay assembly shown in the datasheet.
- 9/. M3 pad to be used only when the relay has a center pin (e.g. ER411M3-12A, 722XM3-26.)

APPENDIX A : Ground Pin Positions



TO-5 Relays:

ER412, ER412T, ER422, ER432, ER432T, 712, 712TN, 400H, 400K, 400V, RF300, RF303, RF341, RF312, RF332, RF310, RF313, RF320, RF323, SI800, SI803, RF700, RF703

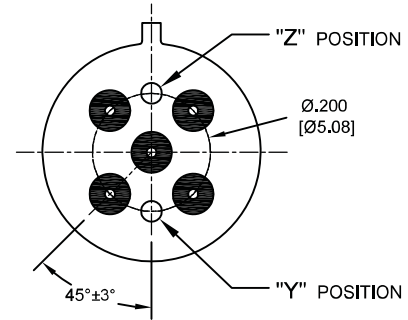

TO-5 Relays:

ER411, RF311, RF331

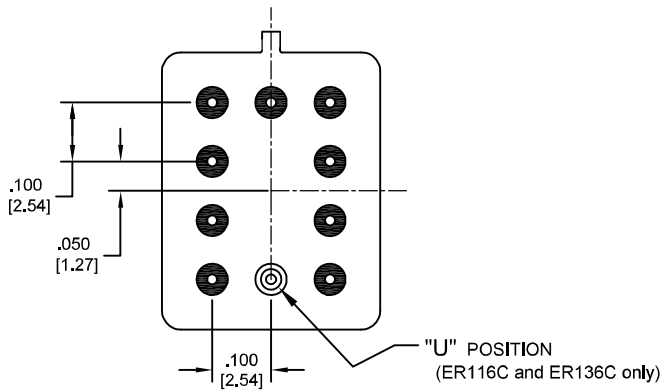

Centigrid® Relays:

RF180, ER116C, 122C, ER136C

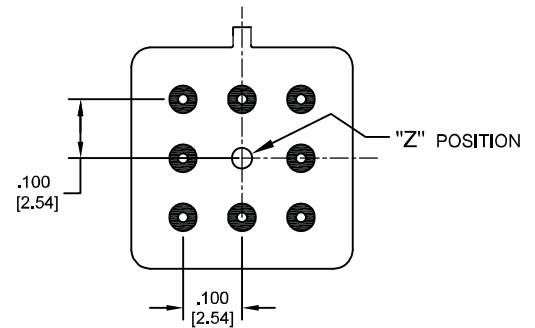

Centigrid® Relays:

RF100, RF103, ER114, ER134, 172



Loopback Relays:

LB363

NOTES

- Indicates ground pin position
- Indicates glass insulated lead position
- ⊙ Indicates ground pin or lead position depending on relay type

1. Terminal views shown
2. Dimensions are in inches (mm)
3. Tolerances: $\pm .010$ ($\pm .25$) unless otherwise specified
4. Ground pin positions are within $.015$ (0.38) dia. of true position
5. Ground pin head dia., 0.035 (0.89) ref: height 0.010 (0.25) ref.
6. Lead dia. 0.017 (0.43) nom.

X-ON Electronics

Largest Supplier of Electrical and Electronic Components

Click to view similar products for [High Frequency / RF Relays](#) category:

Click to view products by [Teledyne](#) manufacturer:

Other Similar products are found below :

[134M4-26](#) [134YZM4-12](#) [136CM9-5](#) [ER136CZM9-5B](#) [ER412DYM-12B](#) [ER412TM-26B/Q](#) [J114DM4-26M/Q](#) [JMSCD-12XP](#) [3SBH1020A2](#)
[412TM-18](#) [422DM-26](#) [411T-12](#) [LB363-100-5](#) [ER412DM4-5B](#) [D3210](#) [ARN10A12](#) [ER116C-26A](#) [ER114ZM4-12A/SQ](#) [ER412-26B/Q](#)
[ER134DYZ-12A](#) [ER421D-26B](#) [21 AT5](#) [30-200ZA](#) [36 AT5](#) [36-200ZA](#) [27 AT5](#) [48-000ZA](#) [IM05JR](#) [R591362640](#) [R591723400](#) [SGRF100-](#)
[12](#) [HF3 02](#) [R594F73617](#) [R594873417](#) [R595863115](#) [IM05CGR](#) [IM02CGR](#) [IM21TS](#) [732TN-26](#) [IM03PNS](#) [IM03PGR](#) [IMB06CTS](#) [3-](#)
[1462037-1](#) [1462041-3](#) [1462051-5](#) [1462050-1](#) [1462050-2](#) [1-1462039-9](#) [ER432DM4-26BSQ](#) [G6K-2F-RF-S-DC5](#) [ARE10A4H](#) [ARE1024](#)
[ARS1012](#)