

Part Number	Description
FS24D10-06	10A, 280 Vac
FS24D10	10A, 280 Vac
FS24D20-06	20A, 280 Vac

**Part Number Explanation**

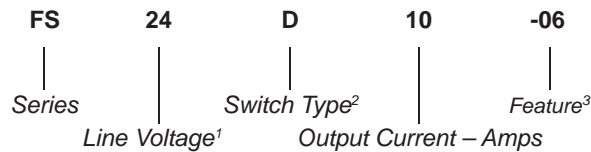

**NOTES**

- 1) Line Voltage 24 = 240 Vac
- 2) Switch Type: D = Zero-cross turn-on
- 3) Feature: -0.6 = Faston terminals

**MECHANICAL SPECIFICATION**

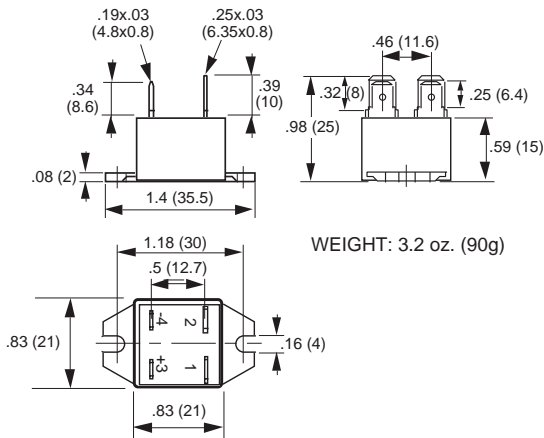

Figure 1 — FS relays except FS24D10

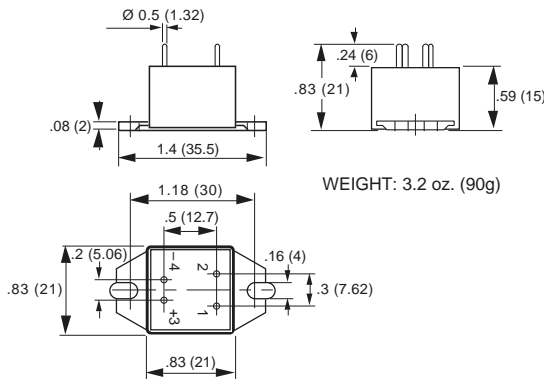

Figure 1b — FS24D10



**FEATURES/BENEFITS**

- Miniature size package
- Designed for medium-power applications
- Faston or PCB terminals available
- Tight zero-cross window for low EMI
- Excellent thermal performance
- High immunity to surges

**DESCRIPTION**

The Series FS relays are designed for medium power loads. The design incorporates a triac output. The Series FS relays utilize optical isolation to protect the control from load transients. The FS compact package is available with faston or PCB terminals. Its compact size makes it ideal for designs where space is limited. The Series FS relays have excellent thermal performance.

**APPLICATIONS**

- Heating control
- Motor control
- Uninterruptible power supplies
- Light dimmers
- Industrial and process control
- On/Off controls of medium-power AC equipment
- Electromechanical line relay replacement

**APPROVALS**

All models are UL recognized.  
UL File Number: E128555.

**EQUIVALENT CIRCUIT**

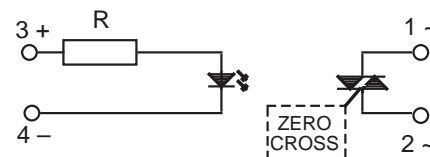

Figure 2 — FS relays

**INPUT (CONTROL) SPECIFICATION**

	Min	Max	Units
Control Range	4	30	Vdc
Input Current Range	3	30	mA <sub>dc</sub>
Must Turn-off Voltage		1	Vdc
Input Resistance (Typical)		1000	Ohms
Reverse Voltage Protection		30	V

**OUTPUT (LOAD) SPECIFICATION**

Input Type	Min	Max	Unit
Operating Range	12	280	V <sub>rms</sub>
Peak Voltage		600	V <sub>peak</sub>
Load Current Range (Resistive)			
10A output current	.005	10	A <sub>rms</sub>
20A output current	.005	20	A <sub>rms</sub>
Inductive Load Current			
10A output current		2.5	A <sub>rms</sub>
20A output current		4	A <sub>rms</sub>
Maximum Surge Current Rating (Non-Repetitive)			
10A output current		120	A
20A output current		200	A
On-State Voltage Drop		1.3	V
Zero Cross Window (Typical)		12	V <sub>ac</sub>
Off-State Leakage Current (60Hz)		3	mA
Turn-On Time (60Hz)		8.3	ms
Turn-Off Time (60Hz)		8.3	ms
Off-State dv/dt		500	V/μs
Maximum di/dt (Non-Repetitive)		50	A/μs

**OUTPUT (LOAD) SPECIFICATION (continued)**

Input Type	Min	Max	Unit
Operating Frequency Range			
	0.1	440	Hz
I <sup>2</sup> T for Match Fusing (<8.3ms)			
10A output current	.005	72	A <sup>2</sup> S
20A output current	.005	200	A <sup>2</sup> S

**CONTROL CHARACTERISTIC**

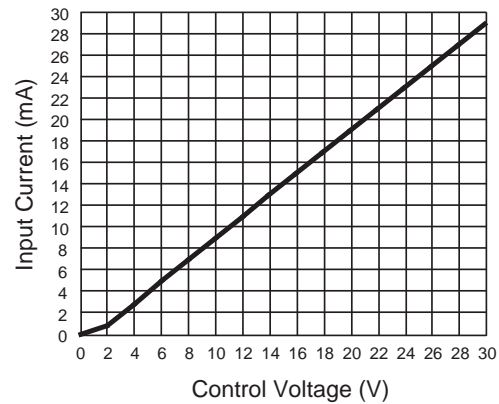

Figure 3 — FS relays

**ENVIRONMENTAL SPECIFICATION**

	Min	Max	Unit
Operating Temperature	-40	100	°C
Storage Temperature	-40	100	°C
Input-Output Isolation	4000		V <sub>rms</sub>
Output-Case Isolation	3300		V <sub>rms</sub>

**NOTES:**

- External snubber is recommended when switching inductive loads.
- Electrical specifications at 25°C unless otherwise specified.
- For 800Hz applications, contact factory.
- For additional/custom options, contact factory.

**THERMAL CHARACTERISTICS**

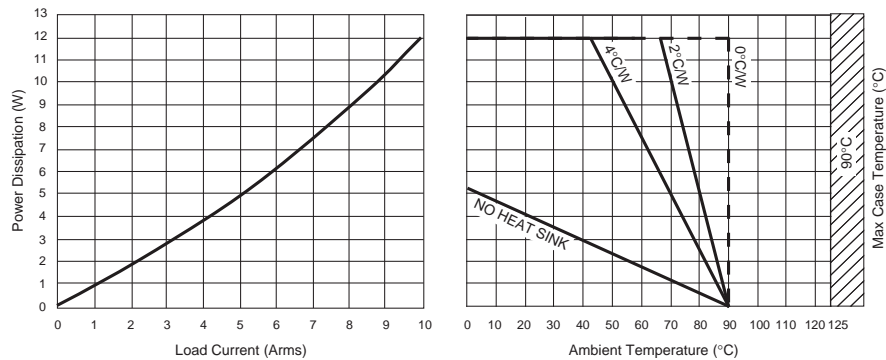

Figure 5a — All 10A FS relays output current

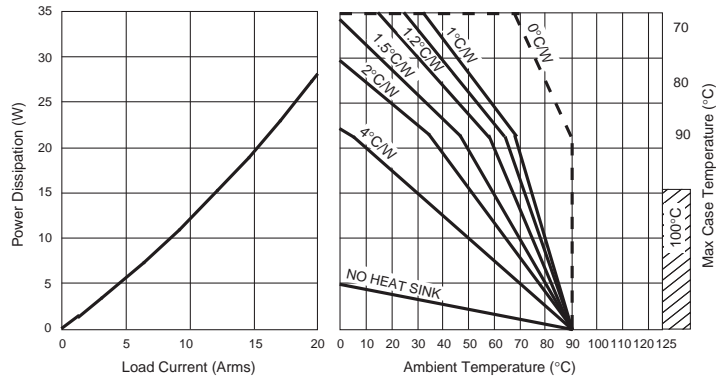

Figure 5b — FS24D20-06 output current

**SURGE CURRENT**

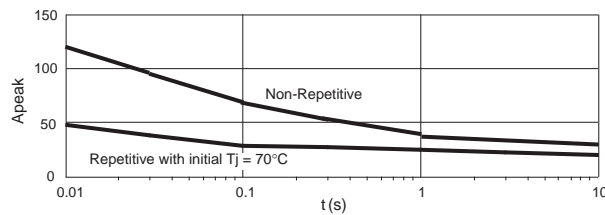

Figure 4a — All 10A FS relays output current

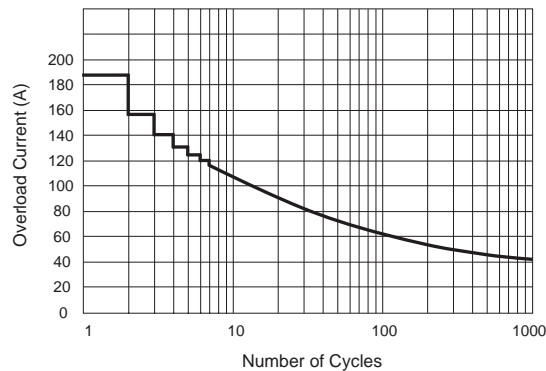

Figure 4b — FS24D20-06 output current

## X-ON Electronics

Largest Supplier of Electrical and Electronic Components

*Click to view similar products for [Solid State Relays - Industrial Mount](#) category:*

*Click to view products by [Teledyne](#) manufacturer:*

Other Similar products are found below :

[D2440-C](#) [H10CA4890](#) [D4875C](#) [1395831-1](#) [1616010-6](#) [BR312BY](#) [A-1326](#) [H10CA4850](#) [H12CA4890VL](#) [RA2410-D06](#) [RA2410HA06T](#)  
[D1202F](#) [D53TP50-10](#) [W230E-1-12](#) [W230T-3-12](#) [1-1617030-3](#) [1-1617033-7](#) [MS2-D2420](#) [MS2-D2430](#) [A-1440](#) [RJ1P60V50E](#) [HS501DR-](#)  
[D2425](#) [RN1F48I50](#) [70.362.1028.0](#) [7-1393030-8](#) [Z5.509.0828.0](#) [G3DZ-4B DC24](#) [G3DZ-F4B DC12](#) [2912138](#) [SSRDAC10](#) [RV8S-L-A240-](#)  
[D24](#) [RV8S-L-A240-D6](#) [RV8S-S-A240-D24](#) [RV8S-S-A240-D6](#) [RV8S-S-A240Z-D24](#) [RV8S-S-D24-A240](#) [RV8S-S-D48-A120](#) [RN1F12V50](#)  
[RJ1P60I30E](#) [RJ1P60V30E](#) [SO967860](#) [SMT8628521](#) [SO869970](#) [SOD867180](#) [SAL961360](#) [SO867970](#) [SOB863860](#) [SOB867640](#) [SOB942360](#)  
[G3PH-5150B DC5-24](#)