

**SURFACE MOUNT  
HIGH REPEATABILITY,  
BROADBAND TO-5 RELAYS  
DPDT**

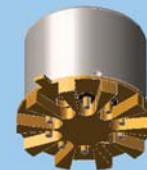

SERIES	RELAY TYPE
GRF300	Repeatable, RF relay
GRF300D	Repeatable, RF relay with internal diode for coil transient suppression
GRF300DD	Repeatable, RF relay with internal diodes for coil transient suppression and polarity reversal protection
GRF303	Sensitive, repeatable, RF relay
GRF303D	Sensitive, repeatable, RF relay with internal diode for coil transient suppression
GRF303DD	Sensitive, repeatable, RF relay with internal diodes for coil transient suppression and polarity reversal protection

**DESCRIPTION**

The ultraminiature GRF300 and GRF303 relays are designed to provide a practical surface-mount solution with improved RF signal repeatability over the frequency range. GRF300 and GRF303 relays feature a unique ground shield that isolates and shields each lead to ensure excellent contact-to-contact and pole-to-pole isolation. The GRF300/GRF303 version with the improved ground connections can push the performance up into the 10Gbps data rates for digital signal integrity applications. This ground shield provides a ground interface that results in improved high-frequency performance as well as parametric repeatability. The GRF300 and GRF303 extend performance advantages over similar RF devices that simply offer formed leads for surface mounting. These relays are engineered for use in RF attenuator, RF switch matrices, ATE and other applications that require dependable high frequency signal fidelity and performance.

**The GRF300 and GRF303 feature:**

- High repeatability
- Broader bandwidth
- Metal enclosure for EMI shielding

- High isolation between control and signal paths
- High resistance to ESD

The following unique construction features and manufacturing techniques provide excellent robustness to environmental extremes and overall high reliability:

- Uniframe motor design provides high magnetic efficiency and mechanical rigidity
- Minimum mass components and welded construction provide maximum resistance to shock and vibration
- Advanced cleaning techniques provide maximum assurance of internal cleanliness
- Gold-plated precious metal alloy contacts ensure reliable switching
- Hermetically sealed

The Series GRF300D/GRF303D and GRF300DD/GRF303DD relays have internal discrete silicon diodes for coil suppression and polarity reversal protection. This hybrid package reduces required PC board floor space by reducing the number of external components needed to drive the relay.

**ENVIRONMENTAL AND  
PHYSICAL SPECIFICATIONS**

<b>Temperature</b> (Ambient)	<b>Storage</b>	-65°C to +125°C
	<b>Operating</b>	-55°C to +85°C
<b>Vibration</b> (General Note I)		10 g's to 500 Hz
<b>Shock</b> (General Note I)		30 g's, 6ms half sine
<b>Enclosure</b>		Hermetically sealed
<b>Weight</b>	<b>GRF300</b>	0.09 oz. (2.55g) max.
	<b>GRF303</b>	0.16 oz. (4.5g) max.

**INTERNAL CONSTRUCTION**

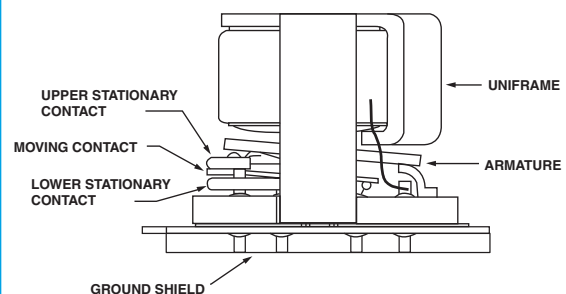

**SERIES GRF300/GRF303**  
**TYPICAL RF CHARACTERISTICS (See RF Notes)**

Isolation Across Contacts (RF Note 4)

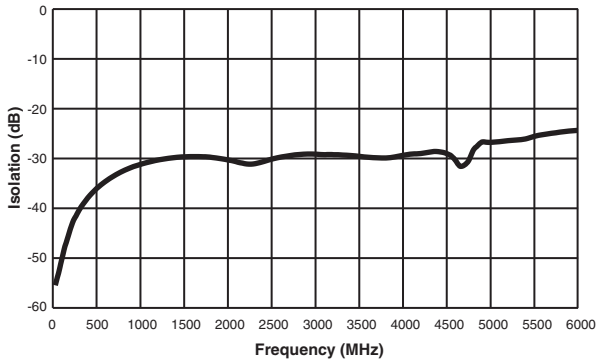

Isolation Pole to Pole (RF Note 5)

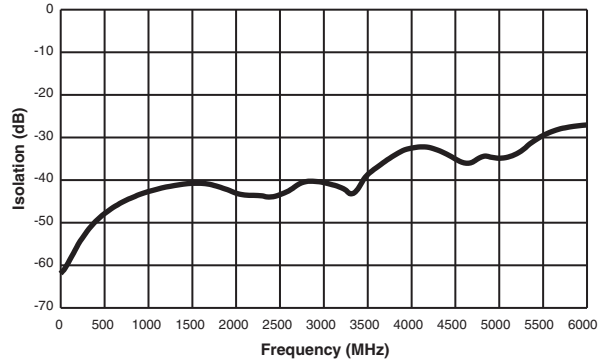

Insertion Loss (RF Note 6)

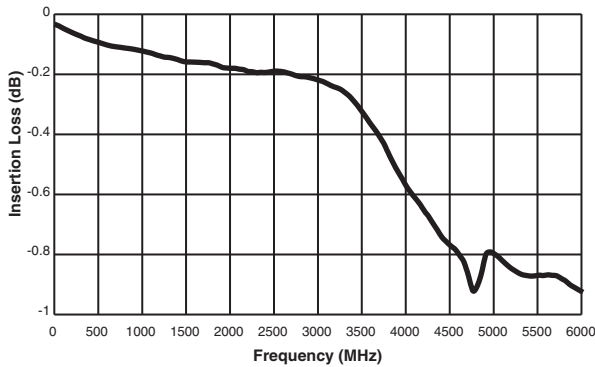

VSWR (RF Note 6)

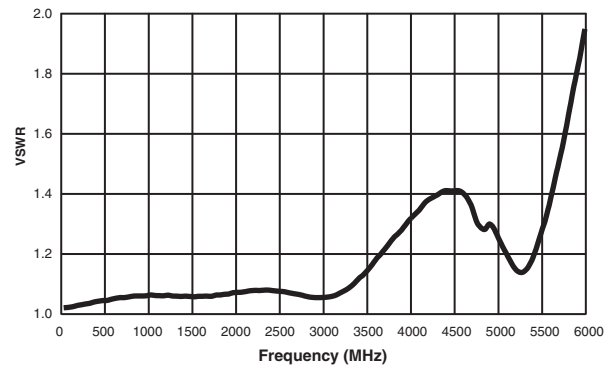

GRF300 Time Response (RF Note 6)

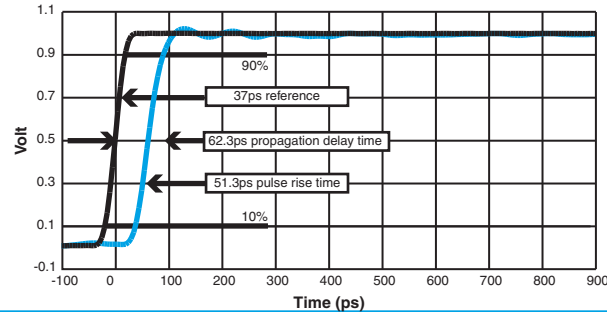

**RF NOTES**

- Test conditions:
  - Fixture: .031" copper clad, reinforced PTFE, RT/duroid® 6002 with SMA connectors. (RT/duroid® is a registered trademark of Rogers Corporation.)
  - RF ground shield is soldered to PCB RF ground plane.
  - Room ambient temperature.
  - Terminals not tested were terminated with 50-ohm load.
  - Contact signal level: -10 dBm.
  - No. of test samples: 2.
- Data presented herein represents typical characteristics and is not intended for use as specification limits.
- Data is per pole, except for pole-to-pole data.
- Data is the average from readings taken on all open contacts.
- Data is the average from readings taken on poles with coil energized and de-energized.
- Data is the average from readings taken on all closed contacts.
- Test fixture effect de-embedded from frequency and time response data.

**SERIES GRF300 AND GRF303**  
**TYPICAL RF INSERTION LOSS REPEATABILITY CHARACTERISTICS**  
(See RF Insertion Loss Repeatability Notes)

REPEATABILITY CHARACTERISTICS GRF300 RELAYS

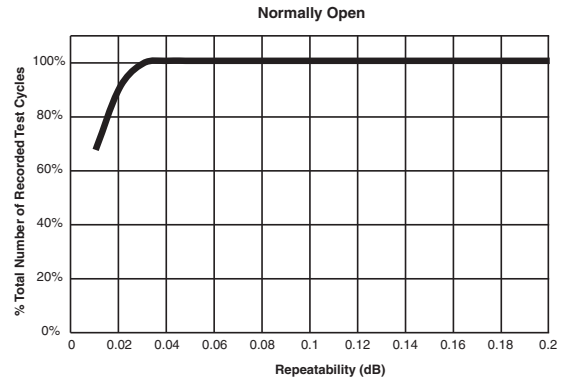
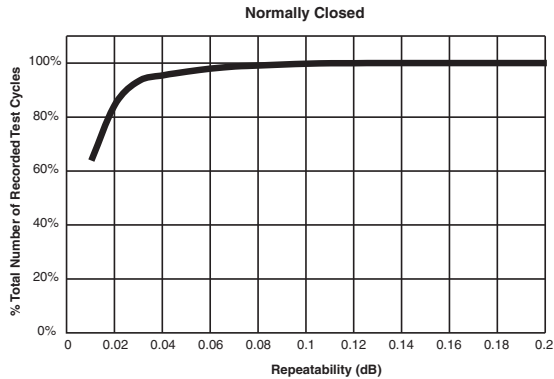

REPEATABILITY CHARACTERISTICS GRF303 RELAYS

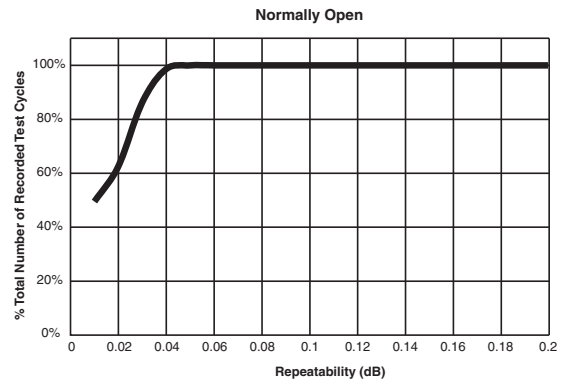
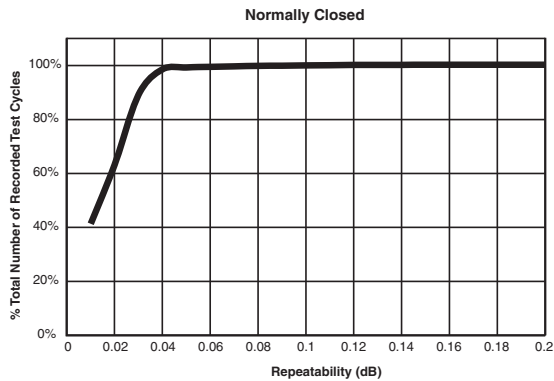

**RF INSERTION LOSS REPEATABILITY NOTES**

- Test conditions:
  - Fixture: .031" copper clad, reinforced PTFE, RT/duroid® 6002 with SMA connectors. (RT/duroid® is a registered trademark of Rogers Corporation.)
  - Test performed at room ambient temperature.
  - Contact signal level: 20dBm.
- Data presented herein represents typical characteristics and is not intended for use as specification limits.
- Insertion loss repeatability measured over frequency range from 50MHz to 4GHz.

**SERIES GRF300/GRF303**

**TYPICAL RF REPEATABILITY PERFORMANCE (See RF Notes 1,2 and 3)**

**1 Million Cycle Repeatability      ±0.1 dB from DC to 3GHz**

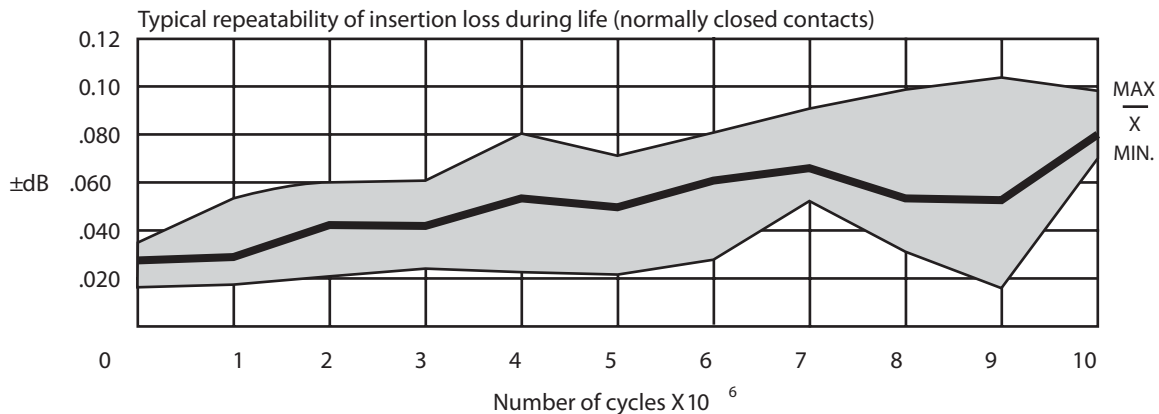
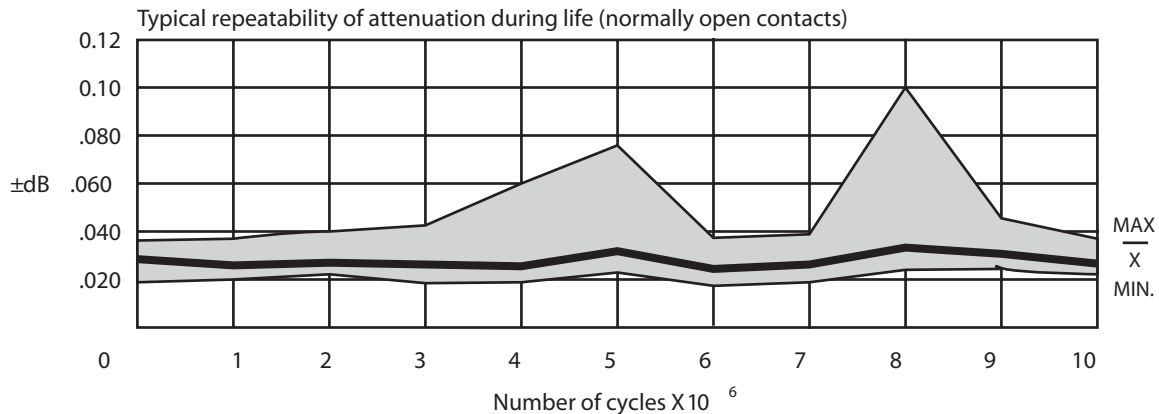

**RF NOTES**

1. One million cycle repeatability data is based upon 396 observations with an average repeatability ±0.033 dB and a range of ±0.093 dB.
2. Repeatability of attenuation values were obtained from tests conducted in a 20 dB attenuator network with a 0 dBm input signal.
3. Relay operates at frequencies higher than 3 GHz with reduced RF performance characteristics.
4. Curves were developed from tests performed on a 0.031" copper clad, reinforced PTFE circuit board at 20°C (ref). The unused contacts were terminated in 50 ohms; characteristic impedance of measuring equipment is 50 ohms. The relays were mounted flush to the circuit board ground plane without the relay header soldered to the ground plane.

### SERIES GRF300/GRF303 GENERAL ELECTRICAL SPECIFICATIONS (@25°C)

<b>Contact Arrangement</b>	2 Form C (DPDT)	
<b>Rated Duty</b>	Continuous	
<b>Contact Resistance</b>	0.15 Ω max.	
<b>Contact Load Rating</b>	Resistive: 1Amp/28Vdc Low level: 10 to 50 μA @ 10 to 50 mV	
<b>Contact Life Ratings</b>	10,000,000 cycles (typical) at low level	
<b>Coil Operating Power</b>	GRF300-5: 500 mW @ nominal coil	GRF300-12: 370 mW @ nominal coil
	GRF303-5: 250 mW @ nominal coil	GRF303-12: 169 mW @ nominal coil
<b>Operate Time</b>	GRF300: 4.0 mS max. GRF303: 6.0 mS max.	
<b>Release Time</b>	GRF300: 3.0 mS max.	GRF300D, GRF300DD: 4.0 mS max.
	GRF303: 3.0 mS max.	GRF303D, GRF303DD: 7.5 mS max.
<b>Intercontact Capacitance</b>	0.4 pf typical	
<b>Insulation Resistance</b>	1,000 MΩ min. between mutually isolated terminals	
<b>Dielectric Strength</b>	350 Vrms (60 Hz) @ atmospheric pressure	
<b>Negative Coil Transient (Vdc)</b>	GRF300D/GRF303D, GRF300DD/GRF303DD	1.0 max
<b>Diode P.I.V. (Vdc)</b>	GRF300D/GRF303D, GRF300DD/GRF303DD	100 min.

### DETAILED ELECTRICAL SPECIFICATIONS (@25°C)

BASE PART NUMBERS (GRF300, GRF300D, GRF300DD)	GRF300-5 GRF300D-5 GRF300DD-5	GRF300-12 GRF300D-12 GRF300DD-12
<b>Coil Voltage, Nominal (Vdc)</b>	5.0	12.0
<b>Coil Resistance (Ohms ±20%)</b>	GRF300, GRF300D	50
	GRF300DD (General Note II)	39
<b>Coil Current (mAdc @ 25 °C)(RF300DD Series)</b>	Min.	93.2
	Max.	128.2
<b>Pick-up Voltage (Vdc max.)</b>	GRF300, GRF300D,	3.6
	GRF300DD	3.9

BASE PART NUMBERS (RF303, RF303D, RF303DD)	GRF303-5 GRF303D-5 GRF303DD-5	GRF303-12 GRF303D-12 GRF303DD-12
<b>Coil Voltage, Nominal (Vdc)</b>	5.0	12.0
<b>Coil Resistance (Ohms ±20%)</b>	GRF303, GRF303D	100
	GRF303DD (General Note II)	64
<b>Coil Current (mAdc @ 25 °C)(RF303DD Series)</b>	Min.	56.8
	Max.	78.1
<b>Pick-up Voltage (Vdc max.)</b>	GRF303, GRF303D,	3.6
	GRF303DD	3.7

**SERIES GRF300 AND GRF303**  
**TYPICAL SIGNAL INTEGRITY CHARACTERISTICS @ 10 Gbps**

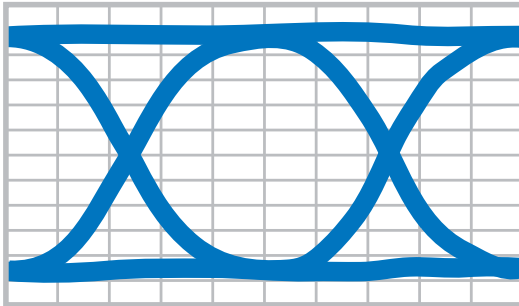

- i.  $R_{tOFF} = 31.1 \text{ pS}$ .
- ii.  $F_{tOFF} = 32 \text{ pS}$ .
- iii.  $V_{OFF} = 511.95 \text{ mVpp}$ .

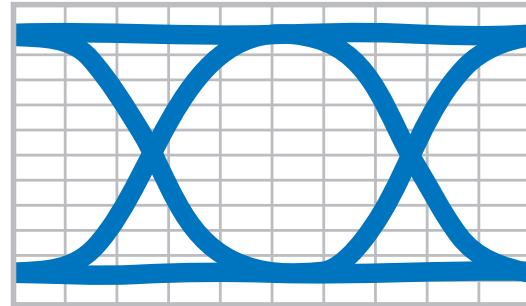

- i.  $R_{tON} = 30.2 \text{ pS}$ .
- ii.  $F_{tON} = 30.7 \text{ pS}$ .
- iii.  $V_{ON} = 512.54 \text{ mV}$

**MEASUREMENTS NOTES**

Measurements were made using the Agilent AG86100 Digital Communication Analyzer with 12GHz-pattern generator and 10GHz-clock source. The relay was mounted on an evaluation board. Two RF 3-foot long cables were used for measurements.

**Pattern Generator Settings**

- $2^{31}-1$  PRBS signal
- 10Gbps data rate
- Data amplitude of 500mVpp

**Oscilloscope Settings**

- Measurement threshold set to 20%–80%

NRZ Eye/Mask mode measurements: rise time, fall time, eye ramp and bit rate

**GRF303 Insertion Loss**

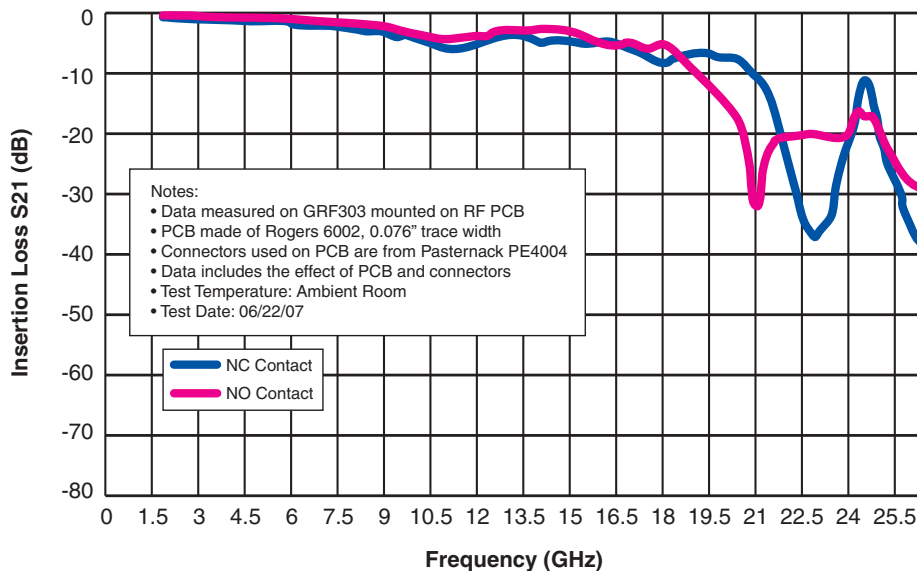

Note: For Insertion Loss measurements in lower bandwidth (<6GHz) see chart on the next page.

**SERIES GRF300/GRF303  
OUTLINE DIMENSIONS**

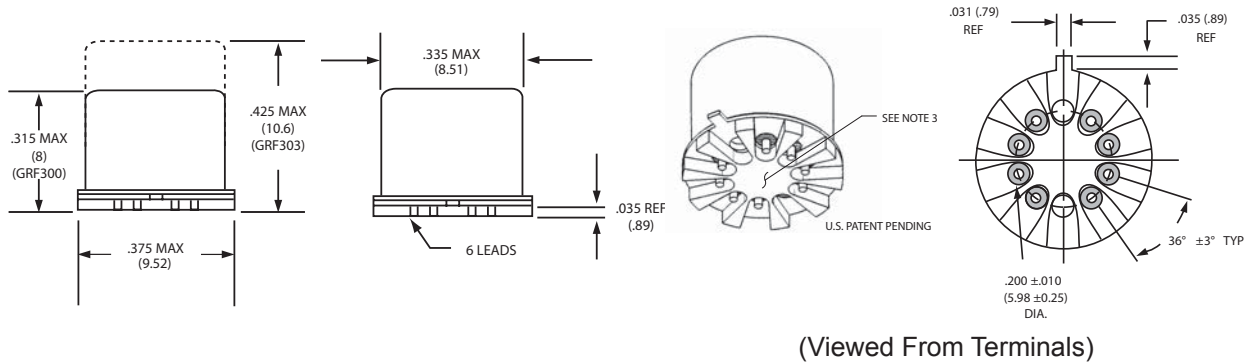

**SCHEMATIC DIAGRAMS**

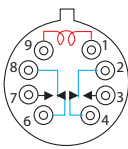

GRF300/GRF303

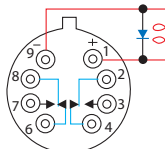

GRF300D/GRF303D

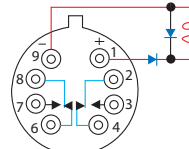

GRF300DD/GRF303DD

**NOTES:**

1. DIMENSIONS ARE IN INCHES, METRIC EQUIVALENTS SHOWN IN [ ].
2. POSITIONS 5 AND 10 ARE FOR UNINSULATED CASE GROUND OPTIONS.
3. NO PROTRUSION BELOW BOTTOM OF HEADER WHEN GROUND PINS ARE INSTALLED
4. TO ORDER THE CASE GROUND OPTION, AFTER THE SERIES DESIGNATOR, ADD "Y" TO THE PART NUMBER FOR POSITION 5 OR "Z" TO THE PART NUMBER FOR POSITION 10.
5. UNLESS OTHERWISE SPECIFIED, TOLERANCES ON DIMENSIONS ARE ± .010 INCH (0.025 MM)

**Teledyne Part Numbering System for GRF300/GRF303 Relays**

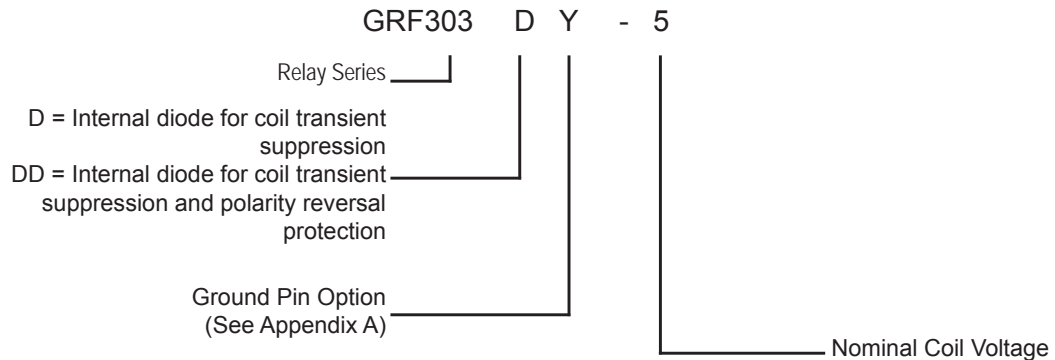

**GENERAL NOTES**

- I. Relays will exhibit no contact chatter in excess of 10 μsec or transfer in excess of 1 μsec.
- II. For reference only. Coil resistance not directly measureable at relay terminals due to internal series diode.

**SERIES GRF300/GRF303**  
**TYPICAL SIGNAL INTEGRITY CHARACTERISTICS @ 10 Gbps**

**Normally Closed (Typ.)**

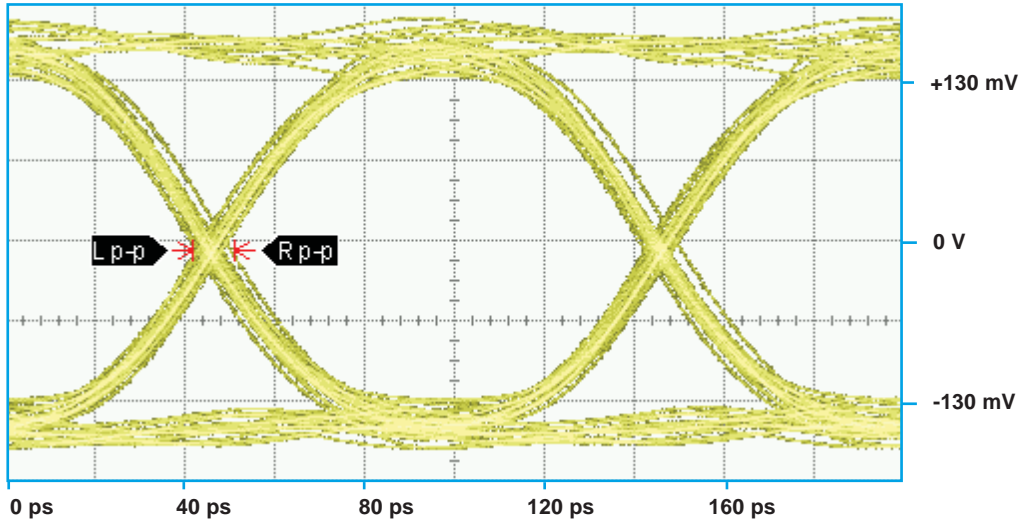

Bit Rate	Eye Height	Eye Width	Jitter <sub>P-P</sub>
10 Gbps	237.6 mV	90.08 ps	9.33 ps

**Normally Open (Typ.)**

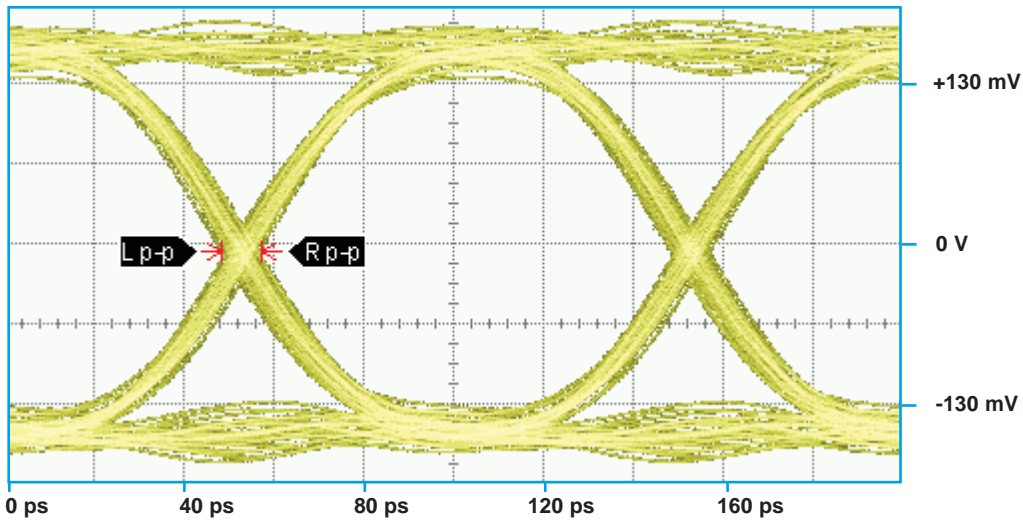

Bit Rate	Eye Height	Eye Width	Jitter <sub>P-P</sub>
10 Gbps	255.2 mV	88.93 ps	8.89 ps

**PATTERN GENERATOR SETTINGS**

- 10 Gbps Random Pulse Pattern Generator
- $2^{31} - 1$  PRBS signal
- PRBS output of 300 mV<sub>P-P</sub> (nominal)
- RF PCB effect (negligible) not removed from measurement
- Data shown is typical of both poles



**SERIES GRF300/GRF303**  
**TYPICAL SIGNAL INTEGRITY CHARACTERISTICS @ 18 Gbps**

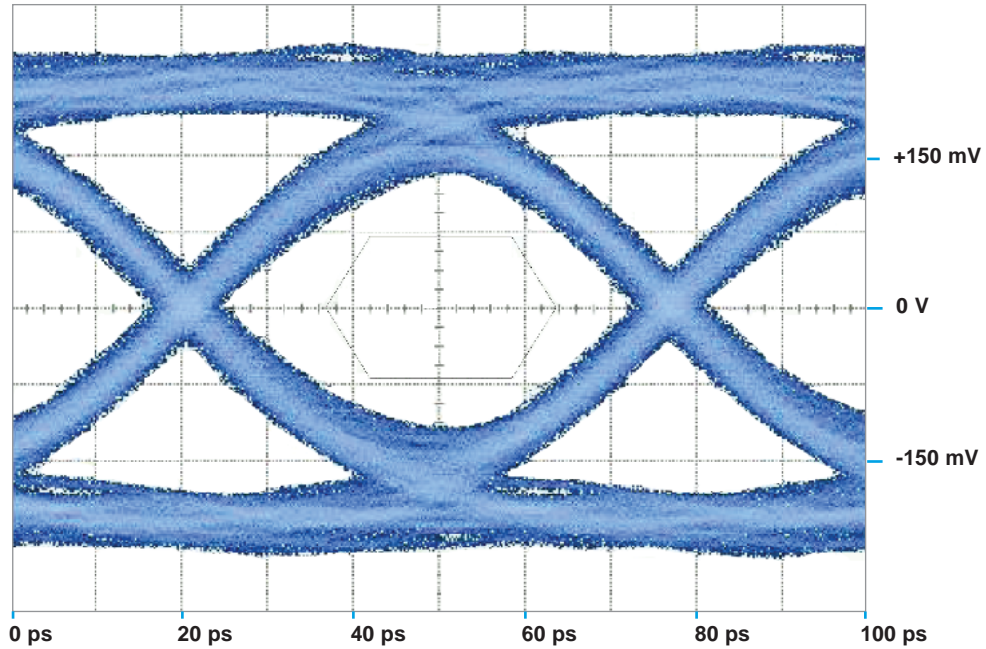

Bit Rate	Eye Height	Eye Width	Jitter <sub>P-P</sub>
18 Gbps	185 mV	46.4 ps	10.44 ps

**PATTERN GENERATOR SETTINGS**

- 18 Gbps Random Pulse Pattern Generator
- $2^{31} - 1$  PRBS signal
- PRBS output of 300 mV<sub>P-P</sub> (nominal)
- RF PCB effect (negligible) not removed from measurement
- Data shown is typical of both poles

## X-ON Electronics

Largest Supplier of Electrical and Electronic Components

*Click to view similar products for [High Frequency / RF Relays](#) category:*

*Click to view products by [Teledyne](#) manufacturer:*

Other Similar products are found below :

[134M4-26](#) [134YZM4-12](#) [136CM9-5](#) [ER136CZM9-5B](#) [ER412DYM-12B](#) [ARA200A4HM01](#) [3SBH1020A2](#) [400-192-10](#) [412TM-18](#)  
[ARN12A12](#) [422DM-26](#) [411T-12](#) [LB363-100-5](#) [D3210](#) [ARN10A12](#) [ER116C-26A](#) [ER114ZM4-5A/SQ](#) [ER114ZM4-12A/SQ](#) [ER412-26B/Q](#)  
[ER134DYZ-12A](#) [36 AT5](#) [25-200ZA](#) [36 T5](#) [48-000ZA](#) [27 T5](#) [24-200ZA](#) [27 T5](#) [26-200ZA](#) [27 T5](#) [28-200ZA](#) [ER411DM4-12A/SQ](#)  
[732-5/Q](#) [R591362640](#) [R591723400](#) [R595867120](#) [HF3 02](#) [R594873417](#) [R595863115](#) [IM43TS](#) [IMB03CTS](#) [732TN-26](#) [1-1462038-1](#)  
[IMB06CTS](#) [1462051-5](#) [1462050-1](#) [1462050-2](#) [G6K-2F-RF-S-DC5](#) [ARE10A4H](#) [ARE1024](#) [ARS1012](#) [ARJ22A12](#) [ARS104H](#) [FTR-](#)  
[B3GA4.5Z-B10](#) [FTR-B3CA024Z](#) [1-1462039-7](#)