

# DEBUG IN HIGH DEFINITION



HDO4000A

200 MHz – 1 GHz  
Oscilloscopes



Lowest Noise and  
Powerful Toolbox

**HD4096 Technology**

**Superior User Experience**

**Powerful, Deep Toolbox**

**Exceptional Serial Data Tools**

The HDO4000A with HD4096 Technology provides exceptional signal fidelity with 12-bit resolution and a superior oscilloscope experience to deliver faster time to insight.

# DEBUG IN HIGH DEFINITION

High Definition Oscilloscopes with HD Technology have a variety of benefits that allow the user to debug in high definition. Waveforms displayed by High Definition Oscilloscopes are cleaner and crisper. More signal details can be seen and measured; these measurements are made with unmatched precision resulting in better test results and shorter debug time.



**Experience HD4096 accuracy, detail, and precision and never use an 8-bit oscilloscope again. Whether the application is general-purpose design and debug, high-precision analog, power electronics, automotive electronics, mechatronics, or other specialized applications, the HD4096 technology provides unsurpassed confidence and measurement capabilities.**

## Clean, Crisp Waveforms

When compared to waveforms acquired and displayed using conventional 8-bit oscilloscopes, waveforms captured with HD4096 12-bit technology are dramatically crisper and cleaner, and are displayed more accurately.

## More Signal Details

16x more resolution provides more signal detail. This is especially helpful for wide dynamic range signals in which a full-scale signal must be acquired while at the same time very small amplitude signal details must be analyzed.

## Unmatched Measurement Precision

HD4096 technology delivers measurement precision several times better than conventional 8-bit oscilloscopes. Higher oscilloscope measurement precision provides better ability to assess corner cases and design margins, perform root cause analysis, and create the best possible solution for any discovered design issue.



	HDO4000A	HDO6000A	HDO8000A	HDO9000
HD Technology	HD4096 12 bits	HD4096 12 bits	HD4096 12 bits	HD1024 10 bits
Bandwidth	200 MHz - 1 GHz	350 MHz - 1 GHz	350 MHz - 1 GHz	1 GHz - 4 GHz
Input Channels	4	4	8	4
Sample Rate	10 GS/s	10 GS/s	10 GS/s	40 GS/s
Standard Toolbox	Basic	Advanced	Advanced	Advanced
Serial Data Tools	TD	TDME	TDME	TDME, SDAII, QPHY
User Experience	MAUI with OneTouch	MAUI with OneTouch	MAUI with OneTouch	MAUI with OneTouch



HD1024 technology provides 10 bits of vertical resolution with 4 GHz bandwidth. As with all members of Teledyne LeCroy's HDO family, the HDO9000 utilizes an exceptionally low-noise system architecture that delivers

outstanding effective number of bits (ENOB). Dynamic ADC Configuration permits the ADC to be set to 8, 9, or 10 bits. Optimized filtering provides additional resolution beyond 10 bits (extending up to 13.8 bits).



# DEBUG IN HIGH DEFINITION

Lowest Noise and  
Powerful Toolbox

HDO4000A

# HD4096

High Definition  
Technology

High Signal to  
Noise Input  
Amplifiers

High Sample  
Rate 12-bit  
ADC's



Low Noise  
System  
Architecture

HD4096  
technology  
enables 12 bits of  
vertical resolution  
with 1 GHz bandwidth

- Clean, Crisp Waveforms
- More Signal Details
- Unmatched Measurement Precision



# Deep Toolbox

## OBSESSED WITH TOOLS

HDO4000A has the greatest breadth and depth of tools, ensuring quick resolution of the most complicated debug tasks.



The HDO4000A with **HD4096 Technology** provides **exceptional signal fidelity** with 12-bit resolution and a **superior oscilloscope experience** to deliver **faster time to insight**.

- 1 HD4096 Technology
- 2 Superior User Experience
- 3 Powerful, Deep Toolbox
- 4 Exceptional Serial Data Tools



**Faster  
Time to  
Insight**

**Insight** alone is not enough.

Markets and **technologies** change too rapidly.

The **timing** of **critical design decisions** is significant.

Faster Time to Insight is what matters.



# MAUI® – SUPERIOR USER EXPERIENCE



**MAUI – Most Advanced User Interface** was developed to put all the power and capabilities of the modern oscilloscope right at your fingertips. Designed for touch; all important oscilloscope controls are accessed through the intuitive touch screen. Built for simplicity; time saving shortcuts and intuitive dialogs simplify setup. Made to solve; a deep set of debug and analysis tools helps identify problems and find solutions quickly.

## Designed for Touch

MAUI is designed for touch. Operate the oscilloscope just like a phone or tablet with the most unique touch screen features on any oscilloscope. All important controls are always one touch away. Touch the waveform to position or zoom in for more details using intuitive actions.

## Built for Simplicity

MAUI is built for simplicity. Basic waveform viewing and measurement tools as well as advanced math and analysis capabilities are seamlessly integrated in a single user interface. Time saving shortcuts and intuitive dialogs simplify setup and shorten debug time.

## Made to Solve

MAUI is made to solve. A deep set of integrated debug and analysis tools help identify problems and find solutions quickly. Unsurpassed integration provides critical flexibility when debugging. Solve problems fast with powerful analysis tools.

## MAUI with OneTouch

MAUI with OneTouch introduces a new paradigm for oscilloscope user experience. Dramatically reduce setup time with revolutionary drag and drop actions to copy and setup channels, math functions, and measurement parameters without lifting a finger. Use common gestures like drag, drop, and flick to instinctively interact with the oscilloscope. Quickly enable a new channel, math or measurement using the “Add New” button and simply turn off any trace with a flick of the finger. These OneTouch innovations provide unsurpassed efficiency in oscilloscope operation.

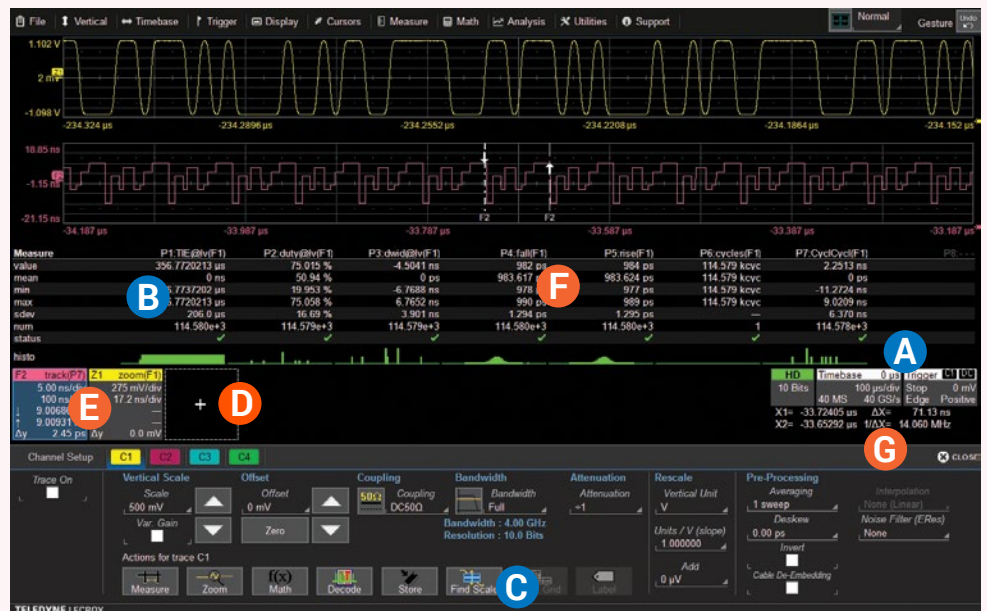

- A** Channel, timebase, and trigger descriptors provide easy access to controls without navigating menus.
- B** Configure parameters by touching measurement results.
- C** Shortcuts to commonly used functions are displayed at the bottom of the channel, math and memory menus.
- D** Use the “Add New” button for one-touch trace creation.
- E** Drag to change source, copy setup, turn on new trace, or move waveform location.
- F** Drag to copy measurement parameters to streamline setup process.
- G** Drag to quickly position cursors on a trace.

# POWERFUL, DEEP TOOLBOX

Capture		View			Measure	Math		Analyze								Document																							
Triggering	Acquire	Display Grids	Display Views	Zooming	Parameters	Parameter Analysis	Functions	Advanced Functions	Pass/Fail	Anomaly Detection	Serial Decode	Serial Message Analysis	Clock & Timing Jitter	Serial Data Jitter	Serial Data Analysis	Application Packages	Document																						
1	Exclusion	3	Measurement	4	5 MS/s RoI	11	MultiStage	12	Sequence Mode	<div data-bbox="521 380 846 575" data-label="Diagram"> <p>Element Key:</p> <ul style="list-style-type: none"> <li>▲ Invented by LeCroy</li> <li>★ Unique to LeCroy</li> </ul> </div>								2	Hardcopy																				
24	Analog+Digital	25	80 ch	26	4 to 80 Channels	27	Multi-Grid	28	Segment	29	Multi-Zoom	30	All Instance...	31	Statistics	32	Full Memory FFT	33	Digital Filters	34	Mask Test	35	TriggerScan	36	Symbol	37	K28.5	38	Search & Zoom	39	Jitter Track	40-45	Bathub Curve	46	Rj + Blj Views	47	DDR Analysis	48	WaveStudio
47	Serial Data	48	HD 4096	49	High Definition Technology	50	Drag and Drop	51	Waveform Histogram	52	Vertical Zoom	53	Parameter Math	54	Parameter Acceptance	55	Tracks / Trends	56	Processing Web	57	Actions	58	WaveScan	59	Protocol Layer	60	ADDR=0x21 DATA=0x3A	61	Bus Parameters	62	Jitter Histogram	63-67	IsoBER	68	Dj Views	69	LSIB		
69	100 GHz / DBI	70	Q-Scope	71	3D Persistence	72	Auto-Scroll	73	Custom Measure	74	Histogram/Histogram	75	Demodulation	76	Custom Math	77	Boolean Compare	78	History Mode	79	RPM=1368	80	Application Layer	81	Timing Parameters	82	Jitter Spectrum	83	Jitter Simulation	84	Noise + Crosstalk	85-89	Sim	90	LabNotebook				
91	R/W Separation	92	Multi-Eye View	93	DDR Tj, Rj, Dj	94	Debug Toolkit	95	Virtual Probe	96		97		98		99		100		101		102	ProtoSync	103	Serial GAC Waveform	104	JitKit Views	105	EyeDr / VP	106	VectorLinQ VSA	107-110	QualiPHY	115	Automation				
17	Device Loss	18	Mod	19	Control Loop	20	Harmonics	21	3-Phase	22	Static+Dynamic	23	Zoom+Gate	63		64		65		66		67		107	Ethernet	108	DDR	109	Video	110	mipi								
40		41		42		43		44		45		85		86		87		88		89		111	Automotive	112	PCI EXPRESS	113	USB	114	Storage										

## Our heritage

Teledyne LeCroy's 50+ year heritage is in processing long records to extract meaningful insight. We invented the digital oscilloscope and many of the additional waveshape analysis tools.

## Our obsession

Our tools and operating philosophy are standardized across much of our product line. This deep toolbox inspires insight; and your moment of insight is our reward.

## Our invitation

Our Periodic Table of Oscilloscope Tools explains the toolsets that Teledyne LeCroy has deployed in our oscilloscopes. Visit our interactive website to learn more about them.

[teledynelecroy.com/tools](http://teledynelecroy.com/tools)

# HD4096 TECHNOLOGY – 16X CLOSER TO PERFECT

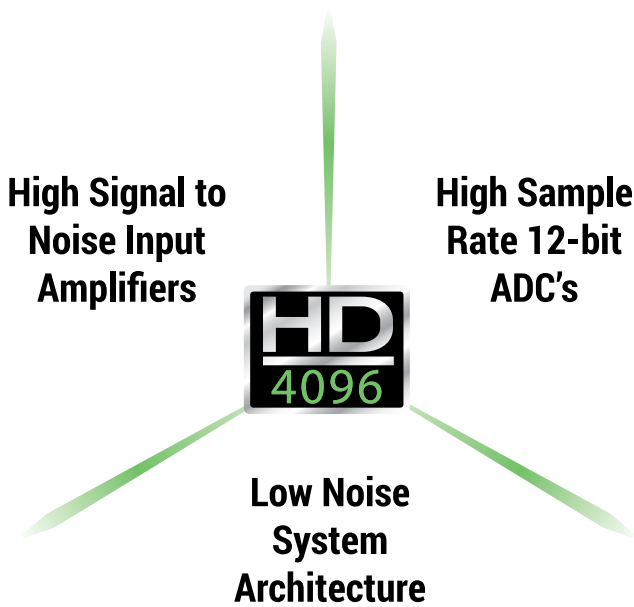

Teledyne LeCroy HDO high definition oscilloscopes use unique HD4096 technology to provide superior and uncompromised measurement performance:

- 12-bit ADCs with high sample rates
- High signal-to-noise amplifiers (55 dB)
- Low noise system architecture (to 1 GHz)

Oscilloscopes with HD4096 technology have higher resolution than conventional 8-bit oscilloscopes (4096 vs. 256 vertical levels) and low noise for uncompromised measurement performance. The 12-bit ADCs support capture of fast signals and oscilloscope bandwidth ratings up to 1 GHz, and Enhanced Sample Rate to 10 GS/s ensures the highest measurement accuracy and precision. The high performance input amplifiers deliver pristine signal fidelity with a 55 dB signal-to-noise ratio. The low-noise system architecture provides an ideal signal path to ensure that signal details are delivered accurately to the oscilloscope display – 16x closer to perfect.

- HD4096 12-bit oscilloscope
- Conventional 8-bit oscilloscope

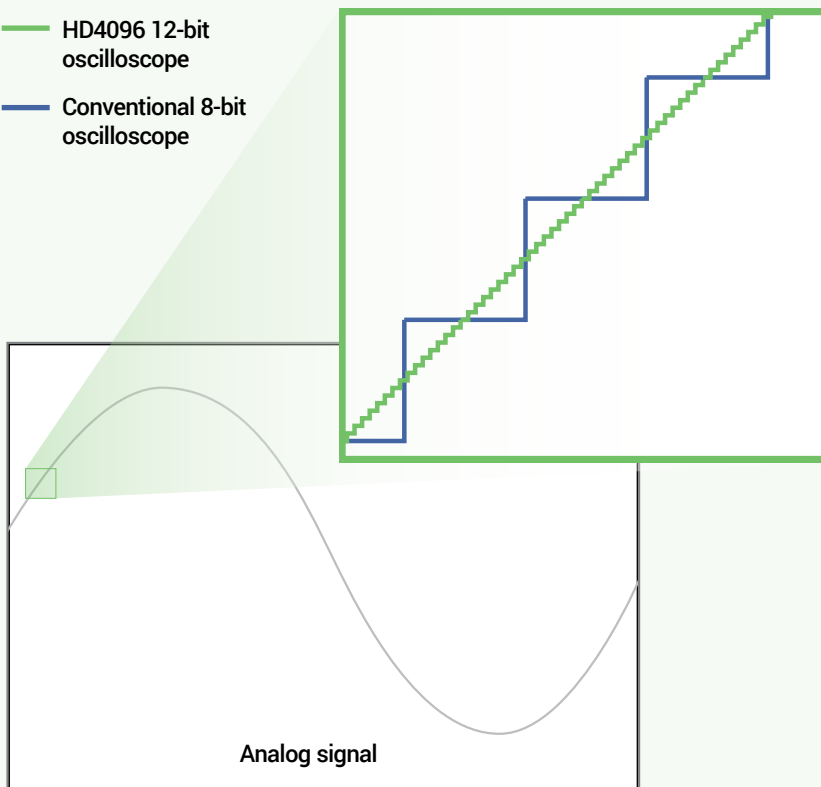

## 16x Closer to Perfect

### 16x more resolution

HD4096 technology provides 12 bits of vertical resolution with 16x more resolution compared to conventional 8-bit oscilloscopes. The 4096 discrete vertical levels reduce the quantization error compared to 256 vertical levels. This improves the accuracy and precision of the signal capture and increases measurement confidence.



# EXPERIENCE THE DIFFERENCE



Experience HD4096 accuracy, detail, and precision and never use an 8-bit oscilloscope again. Whether the application is general-purpose design and debug, high-precision analog, power electronics, automotive electronics, mechatronics, or other specialized applications, the HD4096 technology provides unsurpassed confidence and measurement capabilities.

## Clean, Crisp Waveforms

When compared to waveforms acquired and displayed using conventional 8-bit oscilloscopes, waveforms captured with HD4096 12-bit technology are dramatically crisper and cleaner, and are displayed more accurately. Once you see a waveform acquired with HD4096 technology, you will not want to go back to using a conventional 8-bit oscilloscope.

## More Signal Details

16x more resolution provides more signal detail. This is especially helpful for wide dynamic range signals in which a full-scale signal must be acquired while at the same time very small amplitude signal details must be analyzed. 12-bit acquisitions combined with the oscilloscope's vertical and horizontal zoom can be used to obtain unparalleled insight to system behaviors and problems.

## Unmatched Measurement Precision

HD4096 technology delivers measurement precision several times better than conventional 8-bit oscilloscopes. Higher oscilloscope measurement precision provides better ability to assess corner cases and design margins, perform root cause analysis, and create the best possible solution for any discovered design issue.

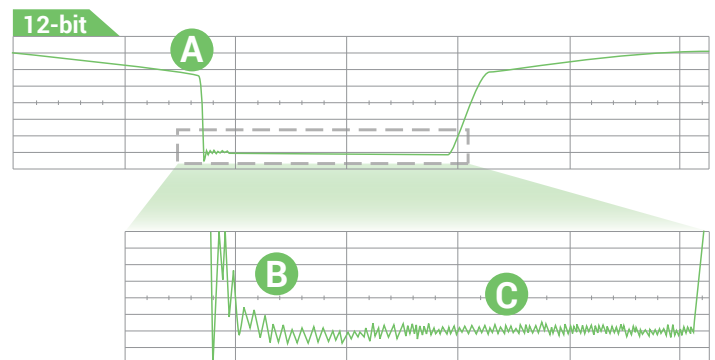
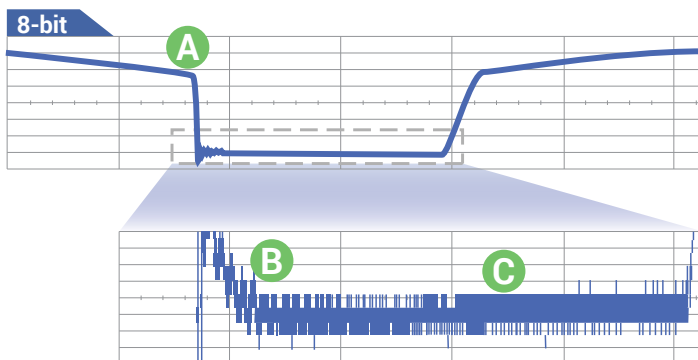

- A Clean, Crisp Waveforms** | Thin traces show the actual waveform with minimal noise interference
- B More Signal Details** | Waveform details lost on an 8-bit oscilloscope can now be clearly seen
- C Unmatched Measurement Precision** | Measurements are more precise and not affected by quantization noise

HDO4000A oscilloscopes have 4 analog input channels, 12-bit resolution using Teledyne LeCroy's HD4096 high definition technology, up to 1 GHz of bandwidth and a compact form factor with a large 12.1" multi-touch display. They are ideal for debug and troubleshooting of power electronics designs, digital power management or power integrity analysis, automotive electronics systems, and deeply embedded or mechatronic designs.

## Key Features

- 4 analog channels
- 12-bit ADC resolution, up to 15-bit with enhanced resolution
- 200 MHz, 350 MHz, 500 MHz and 1 GHz bandwidths
- Long Memory – up to 50 Mpts
- Multi-language User Interface
- WaveScan - Search and Find
- LabNotebook Documentation and Report Generation
- History Mode
- Spectrum Analyzer Mode
- Power Analysis Software
- 16 Digital Channel MSO option
- Serial Trigger and Decode options
- 12.1" WXGA multi-touch screen display
- Wide probe selection for power electronics, embedded electronics, and mechatronics applications



## Power Electronics

Measure single-device(s), half, or Full/H-bridge outputs, including gate-drive voltages. Measure device loss or switch-mode power supply power or control loop performance, including line harmonics. The best performing HV probes support full characterization of all aspects of the power conversion system.

## Automotive Electronics

Automotive electronic control units (ECUs) are tested to stringent standards. 12-bits and 250 Mpts provides the amplitude and time resolution needed for better and more intuitive cause-effect analog signal analysis. Deep digital logic capture and extensive serial data toolsets provides an all-in-one characterization tool for the complex, dynamic behavior of the vehicle ECUs.

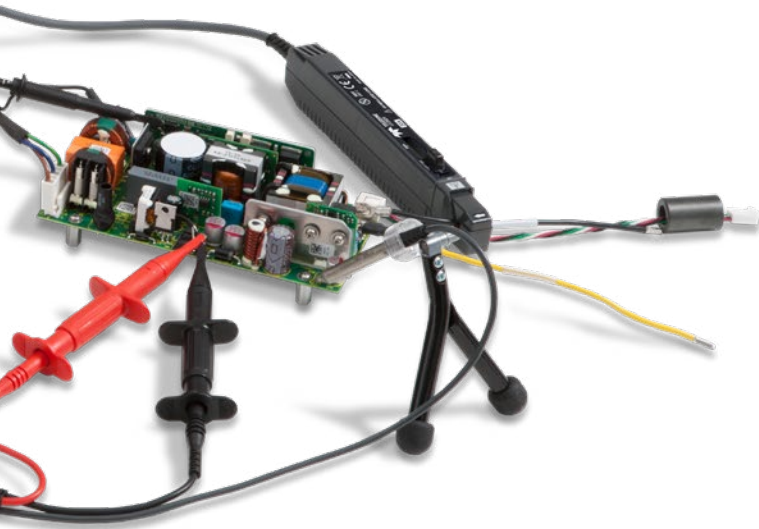

### Digital Power Management, Power Integrity

12-bit accuracy and precision and 1 GHz of bandwidth is perfect for transient rail response, rail voltage power integrity, crosstalk and harmonics evaluation. Specialized probes, analysis software, and serial decoders make fast work of complex embedded system power management and integrity validation.

### Deeply Embedded and Mechatronic Systems

Today's consumer appliances and industrial systems combine complex embedded controls, power electronics, and sensors to achieve the highest efficiency and provide important control and other benefits. Time-to-market, cost and quality pressures place exceptional demands on new product test, debug and troubleshooting.

- 1 Only 13 cm (5") Deep – The most space-efficient oscilloscope for your bench from 200 MHz to 1 GHz
- 2 12.1" Widescreen (16 x 9) high resolution WXGA color multi-touch screen display.
- 3 Built-in stylus for touch screen
- 4 "Push" Knobs – All knobs have push functionality that provides shortcuts to common actions such as Set to Variable, Find Trigger Level, Zero Offset, and Zero Delay
- 5 Waveform Control Knobs for channel, zoom, math and memory traces
- 6 Dedicated buttons to quickly access popular debug tools
- 7 Easy connectivity with two convenient USB 2.0 ports on the front, four USB 3.1 ports on the side
- 8 Mixed Signal Capability - Debug complex embedded designs with integrated 16 channel mixed signal capability
- 9 Rotating and Tilting Feet provide 4 different viewing positions
- 10 Auxiliary Output and Reference Clock Input/Output connectors for connecting to other equipment
- 11 USBTMC (Test and Measurement Class) port simplifies programming

The HDO4000A High Definition Oscilloscopes offer powerful mixed signal solutions that combine high definition analog channels with the flexibility of digital inputs. The HDO4000A-MS options provide an integrated 16 digital channels and a 1.25 GS/s sampling rate to create an all-in-one debug machine.

## Integrated 16-Channel Mixed Signal Capability

With embedded systems growing more complex, powerful mixed signal debug capabilities are an essential part of modern oscilloscopes. The 16 integrated digital channels and set of tools designed to view, measure and analyze analog and digital signals enable fast debugging of mixed signal designs.

## Extensive Triggering

Flexible analog and digital cross-pattern triggering across all 20 channels provides the ability to quickly identify and isolate problems in an embedded system. Event triggering can be configured to arm on an analog signal and trigger on a digital pattern.

## Advanced Digital Debug Tools

Using the powerful parallel pattern search capability of WaveScan, patterns across many digital lines can be isolated and analyzed. Identified patterns are presented in a table with timestamp information and enables quick searching for each pattern occurrence.

Use a variety of the many timing parameters to measure and analyze the characteristics of digital busses. Powerful tools like tracks, trends, statistics and histicons provide additional insight and help find anomalies.

Quickly see the state of all the digital lines at the same time using convenient activity indicators.



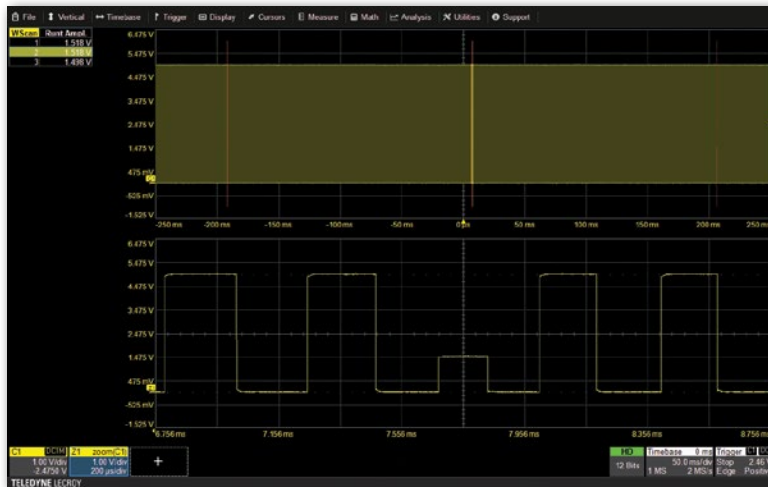

## WaveScan Advanced Search

WaveScan provides powerful isolation capabilities that hardware triggers can't provide. WaveScan allows searching analog, digital or parallel bus signal in a single acquisition using more than 20 different criteria. Or, set up a scan condition and scan for an event over hours or even days.

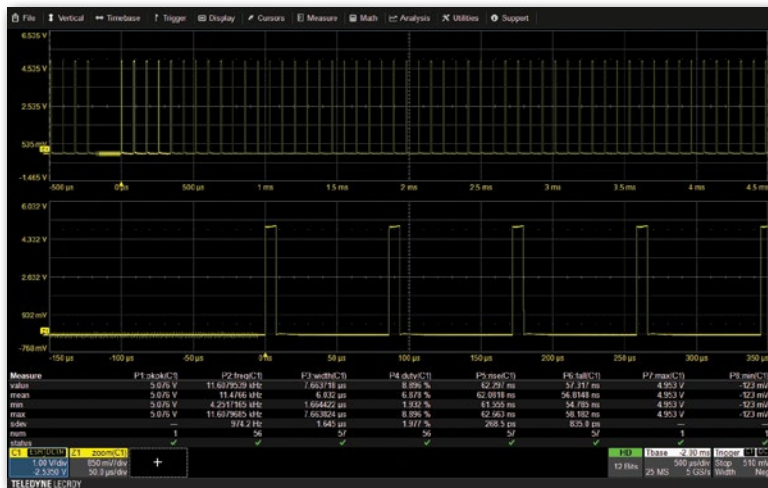

## Advanced Math and Measure

With many math functions and measurement parameters available, the HDO4000A can measure and analyze every aspect of analog and digital waveforms. By utilizing HD4096 technology, the HDO4000A measures 16 times more precisely than traditional 8-bit architectures. Additionally, the HDO4000A provides statistics, histograms and trends to show how waveforms change over time.

## History Mode Waveform Playback

Scroll back in time using History Mode to view previous waveforms and isolate anomalies. Use cursors and measurement parameters to quickly find the source of problems. History mode is always available with a single button press, no need to enable this mode and never miss a waveform.

*Go Back in Time to Identify the Source of a Problem*

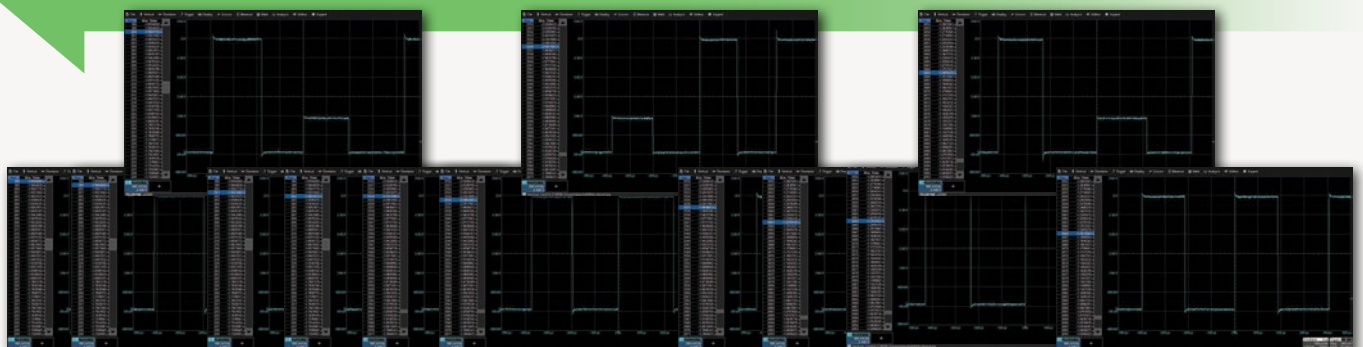

# EXCEPTIONAL SERIAL DATA TOOLS

The HDO4000A features the widest range and most complete serial data debug toolsets.

- Triggering
- Decoding

## HDO4000A Serial Data Protocol Support

	Trigger	Decode
Embedded Computing	I <sup>2</sup> C	• •
	SPI	• •
	UART-RS232	• •
	USB2-HSIC	• •
Automotive + Industrial	CAN	• •
	CAN FD	• •
	FlexRay	• •
	LIN	• •
	SENT	• •
Avionics	ARINC429	• •
	MIL-STD-1553	• •
	SPACEWIRE	• •
Computing + Peripherals	Ethernet (10/100Base-T)	• •
	MDIO	• •
	USB 1.1/2.0	• •
	8b/10b	• •
	D-PHY/CSI-2/DSI	• •
MIPI	DigRF3G	• •
	DigRFv4	• •
Other	SPMI	• •
	Audio (I <sup>2</sup> S, LJ, RJ, TDM)	• •
	Manchester	• •
	NRZ	• •

# T D

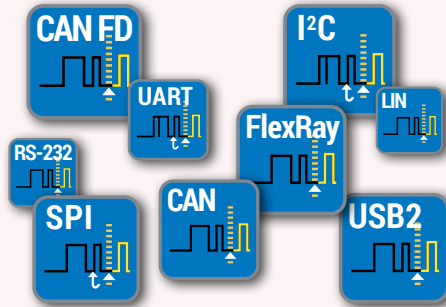

## Trigger

Powerful, flexible triggers designed by people who know the standards, with the unique capabilities you want to isolate unusual events. Conditional data triggering permits maximum flexibility and highly adaptable error frame triggering is available to isolate error conditions. Efficiently acquire bursted data using Sequence Mode to maximize the oscilloscope's memory usage. Sequence Mode enables the oscilloscope to ignore idle time and acquire only data of interest.

## Decode

Decoded protocol information is color-coded to specific portions of the serial data waveform and transparently overlaid for an intuitive, easy-to-understand visual record. All decoded protocols are displayed in a single time-interleaved table. Touch a row in the interactive table to quickly zoom to a packet of interest and select a column header to create filter criteria, as is commonly done in spreadsheets. Easily search through long records for specific protocol events using the built-in search feature.

## LabNotebook Documentation Tool

LabNotebook is a standard feature of HDO4000A and is the ideal documentation tool. LabNotebook automatically saves all displayed waveforms, oscilloscope setup file, and a screen image with a single button press, eliminating the need to navigate multiple menus to save all these files independently. Report files can be annotated and shared with colleagues to fully document all results. Easily recreate experiments and compare tests results amongst colleagues across the world by recalling LabNotebook files back onto the oscilloscope or view on a PC using WaveStudio.

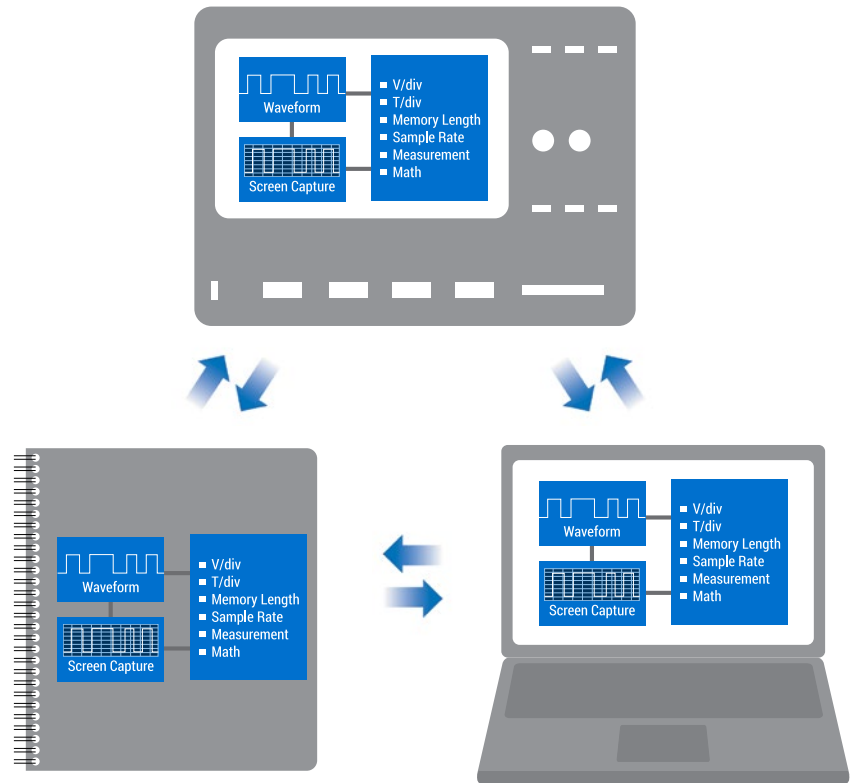

## Advanced Waveform Capture with Sequence Mode

Use Sequence mode to store up to 10,000 triggered events as segments. This is ideal when capturing fast pulses in quick succession or when capturing events separated by long time periods. Each segment has a timestamp and dead-time between triggers is less than 1  $\mu$ s. Isolate rate events over time by combining with advanced triggers.

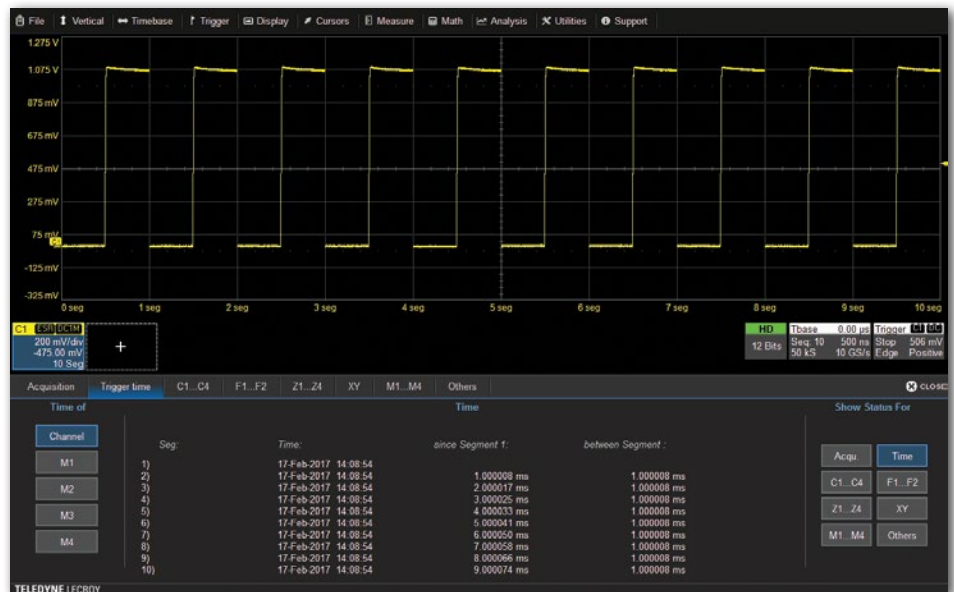

## Key Features

Spectrum analyzer style controls for the oscilloscope

Dual Spectrum Capability

Select from six vertical scales (in dB, V, or A)

Automatic frequency peak identifications

Display up to 20 markers, with interactive table readout of frequencies and levels

Easily make measurements with reference and delta markers

Automatically identify and mark fundamental frequency and harmonics

Spectrogram shows how spectra changes over time in 2D or 3D views



Use two independent input settings and frequency ranges for advanced spectrum analysis.

## Simplify Analysis of FFT Power Spectrum

Get faster and better insight to the frequency content of any signal with use of the Spectrum Analyzer mode on the HDO4000A. This mode provides a spectrum analyzer style user interface with controls for start/stop frequency or center frequency and span. The resolution bandwidth is automatically set for best analysis or can be manually selected. Peak search automatically labels spectral components and presents frequency and level in an interactive table. Utilize up to 20 markers to automatically identify harmonics and quickly analyze frequency content by making measurements between reference and delta markers. Spectrograms display a 2D or 3D history of the frequency content to provided insight into how the spectrum changes over time.



Spectrum analyzer style controls simplify waveform analysis in the frequency domain.



# POWER ANALYSIS OPTION



## Key Features

Automated measurement zone identification with color-coded overlays

Control loop and time domain response analysis

Line power and harmonics tests to IEC 61000-3-2

Total harmonic distortion table shows frequency contribution

B-H Curve shows magnetic device saturation

## Power Analyzer Automates Switching Device Loss Measurements

Quickly measure and analyze the operating characteristics of power conversion devices and circuits with the Power Analyzer option. Critical power switching device measurements, control loop modulation analysis, and line power harmonic testing are all simplified with a dedicated user interface and automatic measurements. Areas of turn-on, turn-off, and conduction loss are all identified with color-coded waveform overlays for faster analysis.

Power Analyzer provides quick and easy setup of voltage and current inputs and makes measurements as simple as the push of a button. Tools are provided to help reduce sources of measurement errors and the measurement parameters provide details of single cycle or average device power losses.

Beyond the advanced power loss measurement capabilities, the Power Analyzer modulation analysis capabilities provide insight to understand control loop response to critical events such as a power supply's soft start performance or step response to line and load changes. The Line Power Analysis tool allows simple and quick pre-compliance testing to EN 61000-3-2.

**Teledyne LeCroy offers an extensive range of probes to meet virtually every probing need.**

**ZS Series High Impedance Active Probes**

ZS1000, ZS1000-QUADPAK  
ZS1500, ZS1500-QUADPAK



High input impedance (1 MΩ), low 0.9 pF input capacitance and an extensive set of probe tips and ground accessories make these low-cost single-ended probes ideal for a wide range of applications. The ZS Series is available up to 4 GHz bandwidth.

**Differential Probes (200 MHz – 1.5 GHz)**

ZD1500, ZD1000,  
ZD500, ZD200  
AP033



High bandwidth, excellent common-mode rejection ratio (CMRR) and low noise make these active differential probes ideal for applications such as automotive electronics and data communications. AP033 provides 10x gain for high-sensitivity measurement of series/shunt resistor voltages.

**Active Voltage/Power Rail Probe**

RP4030



Specifically designed to probe a low impedance power/voltage rail. The RP4030 has 30V built-in offset adjust, low attenuation (noise), and high DC input impedance with 4 GHz of bandwidth and a wide assortment of tips and leads, including solder-in and U.FL receptacle connections.

**High Voltage Fiber Optically-isolated Probe**

HVFO103



The HVFO103 is a compact, simple, affordable probe for measurement of small signals (gate-drives, sensors, etc.) floating on an HV bus in power electronics designs, or for EMC, EFT, ESD, and RF immunity testing sensor monitoring. Suitable for up to 35kV common-mode. 140 dB CMRR.

**HVD Series High Voltage Differential Probes**

HVD3102, HVD3106 (1 kV)  
HVD3206 (2 kV)  
HVD3605 (6 kV)



Available with 1, 2 or 6kV common-mode ratings. Excellent CMRR (65 dB @ 1 MHz) at high frequencies is combined with low inherent noise, wide differential voltage range, high offset voltage capabilities, and 1% gain accuracy. The ideal probe for power conversion system test.

**High Voltage Passive Probes**

HVP120,  
PPE4KV, PPE5KV, PPE6KV



The HVP and PPE Series includes four fixed-attenuation probes covering a range from 1 kV to 6 kV. These probes are ideal for lightning/surge or EFT testing, or for probing in-circuit beyond the range of a LV-rate passive probe.

**Current Probes**

CP030, CP030-3M, CP030A  
CP031, CP031A  
CP150, CP150-6M  
CP500, DCS015



Available in bandwidths up to 100 MHz with peak currents of 700 A and sensitivities to 1 mA/div. Extra-long cables (3 or 6 meters) available on some models. Ideal for component or power conversion system input/output measurements. DCS015 deskew calibration source also available.

**Probe and Current Sensor Adapters**

TPA10, TPA10-QUADPAK  
CA10, CA10-QUADPAK



TPA10 adapts supported Tektronix TekProbe-compatible probes to Teledyne LeCroy ProBus interface. CA10 is a programmable adapter for third-party current sensors that have voltage or current outputs proportional to measured current. QUADPAKs of four pieces each are available.

# SPECIFICATIONS



Vertical - Analog Channels	HDO4024A HDO4024A-MS	HDO4034A HDO4034A-MS	HDO4054A HDO4054A-MS	HDO4104A HDO4104A-MS
Bandwidth @ 50 Ω (-3 dB)	200 MHz	350 MHz	500 MHz	1 GHz
Bandwidth @ 1 MΩ (-3 dB)	200 MHz (typical)	350 MHz (typical)	500 MHz (typical)	500 MHz (typical)
Rise Time (10–90%, 50 Ω)	1.75 ns	1 ns	700 ps	450 ps
Input Channels	4			
Vertical Resolution	12-bits; up to 15-bits with enhanced resolution (ERES)			
Effective Number of Bits (ENOB)	8.8 bits	8.7 bits	8.6 bits	8.4 bits
Vertical Noise Floor				
1 mV/div	70 μVrms	85 μVrms	100 μVrms	145 μVrms
2 mV/div	70 μVrms	85 μVrms	100 μVrms	145 μVrms
5 mV/div	75 μVrms	90 μVrms	105 μVrms	150 μVrms
10 mV/div	80 μVrms	95 μVrms	110 μVrms	155 μVrms
20 mV/div	100 μVrms	110 μVrms	130 μVrms	185 μVrms
50 mV/div	195 μVrms	210 μVrms	265 μVrms	275 μVrms
100 mV/div	340 μVrms	360 μVrms	450 μVrms	500 μVrms
200 mV/div	1.00 mVrms	1.10 mVrms	1.25 mVrms	1.75 mVrms
500 mV/div	1.90 mVrms	2.10 mVrms	2.60 mVrms	2.75 mVrms
1 V/div	3.40 mVrms	3.70 mVrms	4.50 mVrms	4.90 mVrms
Sensitivity	50 Ω: 1 mV/div–1 V/div, fully variable; 1 MΩ: 1 mV/div–10 V/div, fully variable			
DC Vertical Gain Accuracy (Gain Component of DC Accuracy)	±(0.5%) F.S, offset at 0 V			
Channel-Channel Isolation	DC-200 MHz: 60 dB (>1000:1), (For any two input channels, same V/div settings, typical)	DC-200 MHz: 60 dB (>1000:1), 200 MHz up to rated BW: 50 dB (>300:1), (For any two input channels, same V/div settings, typical)	DC-200 MHz: 60 dB (>1000:1), 200 MHz up to rated BW: 50 dB (>300:1), (For any two input channels, same V/div settings, typical)	DC-200 MHz: 60 dB (>1000:1), 200-500 MHz: 50 dB (>300:1), 500 MHz up to rated bandwidth: 40 dB (>100:1) (For any two input channels, same V/div settings, typical)
Offset Range	50 Ω: 1 mV - 4.95 mV: ±1.6 V, 5 mV - 9.9 mV: ±4 V, 10 mV - 19.8 mV: ±8 V, 20 mV - 1 V: ±10 V 1 MΩ: 1 mV - 4.95 mV: ±1.6 V, 5 mV - 9.9 mV: ±4 V, 10 mV - 19.8 mV: ±8 V, 20 mV - 100 mV: ±16 V, 102 mV - 198 mV: ±80V, 200 mV - 1 V: ±160 V, 1.02 V - 10 V: ±400 V			
DC Vertical Offset Accuracy	±(1.0% of offset setting + 0.5%FS + 0.02% of max offset + 1mV)			
Maximum Input Voltage	50 Ω: 5 Vrms, 1 MΩ: 400 V max (DC + Peak AC ≤ 10 KHz)			
Input Coupling	50 Ω: DC, GND; 1 MΩ: AC, DC, GND;			
Input Impedance	50 Ω ± 2.0%; 1 MΩ ± 2.0%    16 pF,			
Bandwidth Limiters	20 MHz, 200 MHz			

## Horizontal - Analog Channels

Acquisition Modes	Real-time, Roll, Random Interleaved Sampling (RIS), Sequence
Time/Division Range	200 ps/div - 1.25 ks/div with standard memory (up to 2.5 ks/div with -L memory); RIS available at ≤ 10 ns/div; Roll Mode available at ≥ 100 ms/div and ≤ 5 MS/s
Clock Accuracy	±2.5 ppm + 1.0ppm/year from calibration
Sample Clock Jitter	Up to 10 ms acquired time range: 280 fsrms (internal timebase reference)
Delta Time Measurement Accuracy	$\sqrt{2} * \sqrt{\left(\frac{\text{Noise}}{\text{SlewRate}}\right)^2 + (\text{Sample Clock Jitter})^2 \text{ (RMS)} + (\text{clock accuracy} * \text{reading}) \text{ (seconds)}}$
Jitter Measurement Floor	$\sqrt{\left(\frac{\text{Noise}}{\text{SlewRate}}\right)^2 + (\text{Sample Clock Jitter})^2 \text{ (RMS, seconds, TIE)}}$
Jitter Between Channels	Analog Channels: 2 psrms (TIE, typical); Digital Channels: 350 ps (maximum) between any two channels Analog-Digital Channels: <5ns (maximum) between any analog and any digital channel
Channel-Channel Deskew Range	±9 x time/div. setting, 100 ms max., each channel
External Timebase Reference (Input)	10 MHz ±25 ppm at 0 to 10 dBm into 50 Ω
External Timebase Reference (Output)	10 MHz, 2.0 dBm ±1.5 dBm, sinewave synchronized to reference being used (internal or external reference)

## Acquisition - Analog Channels

Sample Rate (Single-shot)	10 GS/s on all 4 Channels with Enhanced Sample Rate
Sample Rate (Repetitive)	125 GS/s, user selectable for repetitive signals (20 ps/div to 10 ns/div)
Memory Length (# of Segments in Sequence Mode)	Standard: 12.5 Mpts/ch for all channels, 25 Mpts (interleaved) (10,000 segments) Option - L: 25 Mpts/ch for all channels, 50 Mpts (interleaved) (10,000 segments)
Intersegment Time	1 μS
Averaging	Summed averaging to 1 million sweeps; continuous averaging to 1 million sweeps
Enhanced Resolution (ERES)	From 12.5- to 15-bits vertical resolution
Envelope (Extrema)	Envelope, floor, or roof for up to 1 million sweeps
Interpolation	Linear or Sin x/x (2 pt and 4 pt); 5 or 10 GS/s Enhanced Sample Rate defaults to 2 pt or 4 pt Sin x/x respectively

**HDO4024A**  
**HDO4024A-MS**

**HDO4034A**  
**HDO4034A-MS**

**HDO4054A**  
**HDO4054A-MS**

**HDO4104A**  
**HDO4104A-MS**

**Vertical, Horizontal, Acquisition - Digital Channels (with HDO4000A-MS only)**

Input Channels	16 Digital Channels			
Threshold Groupings	Pod 2: D15 - D8, Pod 1: D7 - D0			
Threshold Selections	TTL, ECL, CMOS (2.5 V, 3.3 V, 5 V), PECL, LVDS or User Defined			
Maximum Input Voltage	±30V Peak			
Threshold Accuracy	±(3% of threshold setting + 100mV)			
Input Dynamic Range	± 20V			
Minimum Input Voltage Swing	400mV			
Input Impedance (Flying Leads)	100 kΩ    5 pF			
Maximum Input Frequency	250 MHz			
Sample Rate	1.25 GS/s			
Record Length	Standard:	12.5 MS (25 MS interleaved) - 16 Channels		
	Optional -L:	25 MS (50 MS interleaved) - 16 Channels		
Minimum Detectable Pulse Width	2 ns			
Channel-to-Channel Skew	350 ps			
User Defined Threshold Range	±10 V in 20 mV steps			
User Defined Hysteresis Range	100 mV to 1.4 V in 100 mV steps			

**Triggering System**

Modes	Normal, Auto, Single, and Stop			
Sources	Any input channel, External, Ext/10, or line; slope and level unique to each source (except for line trigger)			
Coupling	DC, AC, HFRej, LFRej			
Pre-trigger Delay	0-100% of memory size (adjustable in 1% increments of 100 ns)			
Post-trigger Delay	0-10,000 Divisions in real time mode, limited at slower time/div settings or in roll mode			
Hold-off	From 2 ns up to 20 s or from 1 to 99,999,999 events			
Trigger and Interpolator Jitter	≤ 4 ps rms (typical)	≤ 4 ps rms (typical)	≤ 3.5 ps rms (typical)	≤ 3.5 ps rms (typical)
Internal Trigger Level Range	±4.1 div from center (typical)			
External Trigger Input Range	Ext: ±400 mV, Ext/10: ±4 V			
Maximum Trigger Rate	1,000,000 waveforms/sec (in Sequence Mode, up to 4 channels)			
Trigger Sensitivity with Edge Trigger (Ch 1-4)	0.9 division: 10 MHz 1.0 divisions: 200 MHz	0.9 division: 10 MHz 1.0 divisions: 200 MHz 2.0 divisions: 350 MHz	0.9 division: 10 MHz 1.0 divisions: 200 MHz 1.5 divisions: 250 MHz 2.0 divisions: 500 MHz	0.9 division: 10 MHz 1.0 divisions: 200 MHz 1.5 divisions: 500 MHz 2.0 divisions: 1 GHz
Trigger Sensitivity with Edge Trigger (External Input)	0.9 division: 10 MHz 1.0 divisions: 200 MHz 2	0.9 division: 10 MHz 1.0 divisions: 200 MHz 2.0 divisions: 350 MHz	0.9 division: 10 MHz 1.0 divisions: 200 MHz 1.5 divisions: 250 MHz 2.0 divisions: 500 MHz	0.9 division: 10 MHz 1.0 divisions: 200 MHz 1.5 divisions: 500 MHz 2.0 divisions: 1 GHz
Max. Trigger Frequency, Smart Trigger	200 MHz	350 MHz	500 MHz	1 GHz

**Trigger Types**

Edge	Triggers when signal meets slope (positive, negative, or either) and level condition
Width	Triggers on positive or negative glitches with selectable widths. Minimum width 1.5ns, Maximum width: 20 s
Glitch	Triggers on positive or negative glitches with selectable widths. Minimum width 1.5ns, Maximum width: 20 s
Window	Triggers when signal exits a window defined by adjustable thresholds
Pattern	Logic combination (AND, NAND, OR, NOR) of up to 5 inputs (4 channels and external trigger input). Each source can be high, low, or don't care. The High and Low level can be selected independently. Triggers at start or end of the pattern.
TV-Composite Video	Triggers NTSC or PAL with selectable line and field; HDTV (720p, 1080i, 1080p) with selectable frame rate (50 or 60 Hz) and Line; or CUSTOM with selectable Fields (1-8), Lines (up to 2000), Frame Rates (25, 30, 50, or 60 Hz), Interlacing (1:1, 2:1, 4:1, 8:1), or Synch Pulse Slope (Positive or Negative)
Runt	Trigger on positive or negative runts defined by two voltage limits and two time limits. Select between 1 ns and 20 ns
Slew Rate	Trigger on edge rates. Select limits for dV, dt, and slope. Select edge limits between 1 ns and 20 ns
Interval	Triggers on intervals selectable between 1 ns and 20 s
Dropout	Triggers if signal drops out for longer than selected time between 1 ns and 20 s
Triggers with Exclusion Technology	Glitch, Width, Interval, Runt, Slew Rate - Trigger on intermittent faults by specifying the expected behavior and triggering when that condition is not met
Qualified (Timeout or State/Edge Qualified)	Triggers on any input source only if a defined state or edge occurred on another input source. Delay between sources is selectable by time or events. (Note: event B pattern trigger cannot include analog channels).
Low Speed Serial Protocol Trigger (Optional)	I2C, SPI (SPI, SSPI, SIOP), UART-RS232, CAN1.1, CAN2.0, CAN FD, LIN, FlexRay, MIL-STD-1553, AudioBus (I2S, LJ, RJ, TDM), USB1.x/2.0

**HDO4024A**  
**HDO4024A-MS**

**HDO4034A**  
**HDO4034A-MS**

**HDO4054A**  
**HDO4054A-MS**

**HDO4104A**  
**HDO4104A-MS**

## Measurement Tools

Measurement Functionality	Display up to 8 measurement parameters together with statistics, including mean, minimum, maximum, standard deviation, and total number. Each occurrence of each parameter is measured and added to the statistics table. . Histicsons provide a fast, dynamic view of parameters and wave shape characteristics. Parameter gates define the location for measurement on the source waveform.
Measurement Parameters - Horizontal + Jitter	Delay (from trigger, 50%), Duty Cycle (50%, @level), Edges (@level), Fall Time (90-10, 20-80), Frequency (50%, @level), Period (50%, @level), $\Delta$ Period (@level), Phase (@level), Rise Time (10-90, 20-80), Skew, Time (@level), $\Delta$ Time (@level), Width+, Width-
Measurement Parameters - Vertical	Amplitude, Base, Maximum, Mean, Minimum, Peak-to-Peak, RMS, Std. Deviation, Top.
Measurement Parameters - Pulse	Area, Base, Fall Time (90-10, 80-20), Overshoot (positive, negative), Rise Time (10-90, 80-20), Top, Width+, Width-

## Math Tools

Math Functionality	Display up to 2 math functions traces (F1-F2). The easy-to-use graphical interface simplifies setup of up to two operations on each function trace, and function traces can be chained together to perform math-on-math.
Math Operators - Basic Math	Average (summed), Average (continuous), Difference (-), Envelope, Floor, Invert (negate), Product (x), Ratio (/), Reciprocal, Rescale (with units), Roof, Sum (+).
Math Operators - Filters	Enhanced resolution (to 15 bits vertical)
Math Operators - Frequency Analysis	FFT (power spectrum, magnitude), up to full record length. Select from Rectangular, VonHann, Hamming, FlatTop and Blackman Harris windows.
Math Operators - Functions	Absolute value, Derivative, Integral, Invert (negate), Reciprocal, Rescale (with units), Square, Square root, Zoom (identity).

## Measurement and Math Integration

Trend (datalog) of up to 1 million measurement parameters.

## Pass/Fail Testing

Pass/Fail Testing	Mask Test (pre-defined or user-defined mask, waveform All In, All Out, Any In, or Any Out conditions) with following THEN Save (waveforms), Stop, Alarm, (send) Pulse, Hardcopy (send email, save screen image, save to clipboard, send to printer), or (save) LabNotebook.
-------------------	---

## Display System

Display Size	Color 12.1" widescreen flat panel TFT-Active Matrix with high resolution touch screen
Display Resolution	WXGA; 1280 x 800 pixels
Number of Traces	Display a maximum of 8 traces. Simultaneously display channel, zoom, memory, math, and X-Y traces
Grid Styles	Auto, Single, Dual, Quad, Octal, Tandem, Quattro, X-Y, Single+X-Y, Dual+X-Y
Waveform Representation	Sample dots joined, or sample dots only

**HDO4024A  
HDO4024A-MS**

**HDO4034A  
HDO4034A-MS**

**HDO4054A  
HDO4054A-MS**

**HDO4104A  
HDO4104A-MS**

## Processor/CPU

Type	Intel® i3-6100 Dual Core, 3.7 GHz (or better)
Processor Memory	8 GB standard standard
Operating System	Microsoft Windows® 10
Oscilloscope Operating Software	Teledyne LeCroy MAUI™ with OneTouch

## Connectivity

Ethernet Port	Supports 2 10/100/1000Base-T Ethernet interface (RJ45 port)
USB Host Ports	4 side USB 3.1 Gen1 ports and 2 front USB 2.0 ports support Windows compatible devices
USB Device Port	1 USBTMC port
GPIB Port (Optional)	Supports IEEE – 488.2 (External)
External Monitor Port	1 HDMI 1.4 and 1 DisplayPort 1.2 Port. Includes support for extended desktop operation with UHD 3840 x 2160 pixel resolution on second monitor. Supports touch screen integration of external monitor (Note: external display cannot use a Fujitsu touch-screen driver).
Remote Control	Via Windows Automation, or via Teledyne LeCroy Remote Command Set

## Probes

Standard Probes	Qty. (4) ±10 Passive Probes
Probing System	ProBus. Automatically detects and supports a variety of compatible probes

## Power Requirements

Voltage	100–240 VAC ±10% at 45-66 Hz; 110-120 VAC ±10% at 380-420 Hz; Automatic AC Voltage Selection; Installation Category 300 V CAT II
Power Consumption (Nominal)	200 W / 200 VA
Max Power Consumption	320 W / 320 VA (with all PC peripherals and active probes connected to 4 channels)

## Environmental

Temperature	Operating: 5 °C to 40 °C; Non-Operating: -20 °C to 60 °C
Humidity	Operating: 5% to 90% relative humidity (non-condensing) up to +31 °C, Upper limit derates to 50% relative humidity (non-condensing) at +40 °C; Non-Operating: 5% to 95% relative humidity (non-condensing) as tested per MIL-PRF-28800F
Altitude	Operating: 3,048 m (10,000 ft) max at +30 °C; Non-Operating: Up to 12,192 meters (40,000 ft)
Random Vibration	Operating : 0.31 g <sub>rms</sub> 5 Hz to 500 Hz, 15 minutes in each of three orthogonal axes; Non-Operating: 2.4 g <sub>rms</sub> 5 Hz to 500 Hz, 15 minutes in each of three orthogonal axes
Functional Shock	30 g <sub>peak</sub> , half sine, 11 ms pulse, 3 shocks (positive and negative) in each of three orthogonal axes, 18 shocks total

## Physical

Dimensions (HWD)	11.48"H x 15.72"W x 5.17"D (291.7 mm x 399.4 mm x 131.31 mm)
Weight	12.9 lbs. (5.86 kg.)

## Certifications

CE Certification UL and cUL Listing	CE Compliant, UL and cUL listed, confirms to: UL 61010-1 (3rd Edition), UL 61010-2-030 (1st Edition) CAN/CSA C22.2 No.61010-1-12
	CE Compliant, UL and cUL listed, confirms to: UL 61010-1 (3rd Edition), UL 61010-2-030 (1st Edition) CAN/CSA C22.2 No.61010-1-12

## Warranty and Service

3-year warranty; calibration recommended annually. Optional service programs include extended warranty, upgrades, and calibration services

# ORDERING INFORMATION



## Product Description Product Code

### HDO4000A Oscilloscopes

200 MHz, 10 GS/s, 4 Ch, 12.5 Mpts/Ch 12-bit HD Oscilloscope with 12.1" WXGA Touch Display	HDO4024A
350 MHz, 10 GS/s, 4 Ch, 12.5 Mpts/Ch 12-bit HD Oscilloscope with 12.1" WXGA Touch Display	HDO4034A
500 MHz, 10 GS/s, 4 Ch, 12.5 Mpts/Ch 12-bit HD Oscilloscope with 12.1" WXGA Touch Display	HDO4054A
1 GHz, 10 GS/s, 4 Ch, 12.5 Mpts/Ch 12-bit HD Oscilloscope with 12.1" WXGA Touch Display	HDO4104A

### HDO4000A-MS Mixed Signal Oscilloscopes

200 MHz, 10 GS/s, 4+16ch, 12.5 Mpts/Ch 12-bit HD Mixed Signal Oscilloscope w/ 12.1" WXGA Color Display	HDO4024A-MS
350 MHz, 10 GS/s, 4+16ch, 12.5 Mpts/Ch 12-bit HD Mixed Signal Oscilloscope w/ 12.1" WXGA Color Display	HDO4034A-MS
500 MHz, 10 GS/s, 4+16ch, 12.5 Mpts/Ch 12-bit HD Mixed Signal Oscilloscope w/ 12.1" WXGA Color Display	HDO4054A-MS
1 GHz, 10 GS/s, 4+16ch, 12.5 Mpts/Ch 12-bit HD Mixed Signal Oscilloscope w/ 12.1" WXGA Color Display	HDO4104A-MS

### Included with Standard Configurations (HDO4000A and HDO4000A-MS)

±10 Passive Probe (Total of 1 Per Channel), Getting Started Guide, Anti-virus Software (Trial Version), Microsoft Windows Embedded Standard 7 P 64-Bit License, Commercial NIST Traceable Calibration with Certificate, Power Cable for the Destination Country, Protective Front Cover, 3-year Warranty

### Included with HDO4000A-MS

16 Channel Digital Leadset, Extra Large Gripper Probe Set (Qty. 22), Ground Extenders (Qty. 20), Flexible Ground Leads (Qty. 5)

### Memory Option

25 Mpts/ch (50 Mpts interleaved) memory	HDO4KA-L
---	----------

### Hardware Options

Removable Solid State Drive Package (includes removable solid state drive kit and two solid state drives)	HDO4KA-RSSD
Additional Removable Solid State Drive	HDO4KA-RSSD-02

### General Accessories

External GPIB Accessory	USB2-GPIB
Soft Carrying Case	HDO4K-SOFTCASE
Rack Mount Accessory	HDO4K-RACK
Accessory Pouch	HDO4K-POUCH

### Local Language Overlays

German Front Panel Overlay	HDO4K-FP-GERMAN
French Front Panel Overlay	HDO4K-FP-FRENCH
Italian Front Panel Overlay	HDO4K-FP-ITALIAN
Spanish Front Panel Overlay	HDO4K-FP-SPANISH
Japanese Front Panel Overlay	HDO4K-FP-JAPANESE
Korean Front Panel Overlay	HDO4K-FP-KOREAN
Chinese (Tr) Front Panel Overlay	HDO4K-FP-CHNES-TR
Chinese (Simp) Front Panel Overlay	HDO4K-FP-CHNES-SI
Russian Front Panel Overlay	HDO4K-FP-RUSSIAN

## Product Description Product Code

### Software Options

Electrical Telecom Mask Test Package	HDO4K-ET-PMT
Spectrum Analysis Option	HDO4K-SPECTRUM
Power Analysis Option	HDO4K-PWR

### Serial Data Options

ARINC 429 Symbolic Decode Option	HDO4K-ARINC429bus DSymbolic
Audiobus Trigger and Decode Option for I <sup>2</sup> S, LJ, RJ, and TDM	HDO4K-Audiobus TD
CAN, LIN and FlexRay Trigger and Decode Option	HDO4K-AUTO
CAN FD Trigger and Decode Option	HDO4K-CAN FDbus TD
CAN Trigger and Decode Option	HDO4K-CANbus TD
D-PHY Decode Option	HDO4K-DPHYbus D
DigRF 3G Decode Option	HDO4K-DigRF3Gbus D
DigRF v4 Decode Option	HDO4K-DigRFv4bus D
ENET Decode Option	HDO4K-ENETbus D
FlexRay Trigger and Decode Option	HDO4K-FlexRaybus TD
I <sup>2</sup> C, SPI and UART Trigger and Decode Option	HDO4K-EMB
I <sup>2</sup> C Bus Trigger and Decode Option	HDO4K-I2Cbus TD
LIN Trigger and Decode Option	HDO4K-LINbus TD
MDIO Decode	HDO4K-MDIObus D
Manchester Decode Option	HDO4K-Manchesterbus D
MIL-STD-1553 Trigger and Decode Option	HDO4K-1553 TD
NRZ Decode Option	HDO4K-NRZbus D
SENT Decode Option	HDO4K-SENTbus D
SPI Bus Trigger and Decode Option	HDO4K-SPIbus TD
SPMI Decode	HDO4K-SPMIbus D
SpaceWire Decode Option	HDO4K-SpaceWirebus D
UART and RS-232 Trigger and Decode Option	HDO4K-UART-RS232bus TD
USB 2.0 Trigger and Decode Option	HDO4K-USB2bus TD
USB2-HSIC Decode Option	HDO4K-USB2-HSICbus D

# ORDERING INFORMATION



Product Description	Product Code
<b>Probes and Amplifiers</b>	
250 MHz Passive Probe for HDO4000A, 10:1, 10 M $\Omega$	PP017
500 MHz Passive Probe 10:1, 10 M $\Omega$	PP018
500 MHz Passive Probe, 5mm, 10:1, 10 M $\Omega$	PP026
Power/Voltage Rail Probe. 4 GHz bandwidth, 1.2x attenuation, $\pm 30V$ offset, $\pm 800mV$	RP4030
Browser for use with RP4030	RP4000-BROWSER
1,500 V, 120 MHz High-Voltage Differential Probe	HVD3106A
1kV, 80 MHz High Voltage Differential Probe with 6m cable	HVD3106A-6M
1kV, 120 MHz High Voltage Differential Probe without tip Accessories	HVD3106A-NOACC
1,500 V, 25 MHz High-Voltage Differential Probe	HVD3102A
1kV, 25 MHz High Voltage Differential Probe without tip Accessories	HVD3102A-NOACC
2kV, 120 MHz High Voltage Differential Probe	HVD3206A
2kV, 80 MHz High Voltage Differential Probe with 6m cable	HVD3206A-6M
6kV, 100 MHz High Voltage Differential Probe	HVD3605A
High Voltage Fiber Optic Probe, 60 MHz (requires accessory tip)	HVFO103
$\pm 1V$ (1x) Tip Accessory for HVFO103	HVFO100-1X-TIP-U
$\pm 5V$ (5x) Tip Accessory for HVFO103	HVFO100-5X-TIP-U
$\pm 10V$ (10x) Tip Accessory for HVFO103	HVFO100-10X-TIP-U
$\pm 20V$ (20x) Tip Accessory for HVFO103	HVFO100-20X-TIP-U
$\pm 40V$ (40x) Tip Accessory for HVFO103	HVFO100-40X-TIP-U
30 A; 100 MHz Current Probe – AC/DC; 30 A <sub>rms</sub> ; 50 A <sub>peak</sub> Pulse	CP031
30 A; 100 MHz High Sensitivity Current Probe – AC/DC; 30 A <sub>rms</sub> ; 50 A <sub>peak</sub> Pulse	CP031A
30 A; 50 MHz Current Probe – AC/DC; 30 A <sub>rms</sub> ; 50 A <sub>peak</sub> Pulse	CP030
30 A, 10 MHz Current Probe - AC/DC, 30 A rms, 50 A Peak Pulse, 3 meter cable	CP030-3M
30 A; 50 MHz High Sensitivity Current Probe – AC/DC; 30 A <sub>rms</sub> ; 50 A <sub>peak</sub> Pulse	CP030A
150 A; 10 MHz Current Probe – AC/DC; 150 A <sub>rms</sub> ; 500 A <sub>peak</sub> Pulse	CP150
150 A, 5 MHz Current Probe - AC/DC, 150 A rms, 500 A Peak Pulse, 6 meter cable	CP150-6M
500 A; 2 MHz Current Probe – AC/DC; 500 A <sub>rms</sub> ; 700 A <sub>peak</sub> Pulse	CP500
Deskew Calibration Source for CP030, CP030A, CP031, CP031A, CP150, CP500	DCS025

Product Description	Product Code
<b>Probes and Amplifiers (cont'd)</b>	
500 MHz Differential Probe	AP033
200 MHz, 3.5 pF, 1 M $\Omega$ Active Differential Probe, $\pm 20 V$ , 60V common-mode	ZD200
1 GHz, 1.0 pF, 1 M $\Omega$ Active Differential Probe, $\pm 8 V$ , 10V common-mode	ZD1000
1.5 GHz, 1.0 pF, 1 M $\Omega$ Active Differential Probe, $\pm 8 V$ , 10V common-mode	ZD1500
500 MHz, 1.0 pF Active Differential Probe, $\pm 8 V$	ZD500
1 GHz, 0.9 pF, 1 M $\Omega$ High Impedance Active Probe	ZS1000
Set of 4 ZS1000	ZS1000-QUADPAK
1.5 GHz, 0.9 pF, 1 M $\Omega$ High Impedance Active Probe	ZS1500
Set of 4 ZS1500	ZS1500-QUADPAK
100:1 400 MHz 50 M $\Omega$ 1 kV High-voltage Probe	HVP120
100:1 400 MHz 50 M $\Omega$ 4 kV High-voltage Probe	PPE4KV
1000:1 400 MHz 50 M $\Omega$ 5 kV High-voltage Probe	PPE5KV
1000:1 400 MHz 50 M $\Omega$ 6 kV High-voltage Probe	PPE6KV
TekProbe to ProBus Probe Adapter	TPA10
Set of 4 TPA10 TekProbe to ProBus Probe Adapters.	TPA10-QUADPAK
Programmable Current Sensor to ProBus Adapter for use with third party current sensors	CA10

## Customer Service

Teledyne LeCroy oscilloscopes and probes are designed, built, and tested to ensure high reliability. In the unlikely event you experience difficulties, our digital oscilloscopes are fully warranted for three years and our probes are warranted for one year. This warranty includes:

- No charge for return shipping
- Long-term 7-year support
- Upgrade to latest software at no charge



1-800-5-LeCroy  
teledynelecroy.com

Local sales offices are located throughout the world.  
Visit our website to find the most convenient location.



## X-ON Electronics

Largest Supplier of Electrical and Electronic Components

*Click to view similar products for [Benchtop Oscilloscopes](#) category:*

*Click to view products by [Teledyne](#) manufacturer:*

Other Similar products are found below :

[MDO32 3-BW-1000](#) [TBS2102B](#) [TBS1072C](#) [TBS1102C](#) [TBS1202C](#) [DSO3064A](#) [DSO5102P](#) [CC-650](#) [GDS-2072A](#) [GDS-2074E](#) [GDS-2202E](#)  
[GDS-2204E](#) [2555](#) [2557](#) [2568](#) [BK2190E](#) [HDO4024A](#) [2540C](#) [2542C](#) [2569-MSO](#) [2190E](#) [DSOX2002A/DSO0000-903](#)  
[MSOX2024A/DSO0000-903](#) [GDS-2202A](#) [MDO-2202EG](#) [MDO-2204EX](#) [HANTEK DSO4084B](#) [HANTEK DSO4084C](#) [HANTEK](#)  
[DSO4104B](#) [HANTEK DSO4104C](#) [HANTEK DSO4204B](#) [HANTEK DSO4204C](#) [HANTEK DSO4254B](#) [DSO-2090](#) [DSO-2150](#) [DSO5062B](#)  
[RTB2K-202](#) [RTC1K-COM2](#) [UTD2025CL](#) [UTD2052CL](#) [CC-65](#) [MSO5102D](#) [MSO5202D](#) [PICOSCOPE5444DMSO](#) [GDS-1054B](#) [GDS-](#)  
[1072B](#) [GDS-1074B](#) [GDS-1102B \(CE\) 2CH](#) [GDS-1104B](#) [GDS-2072E](#)