

A Unit of Teledyne Electronics and Communications

# CENTIGRID® SURFACE MOUNT COMMERCIAL RELAYS SENSITIVE DPDT

## SERIES S134

SERIES DESIGNATION	RELAY TYPE
S134	DPDT basic relay
S134D	DPDT relay with internal diode for coil transient suppression
S134DD	DPDT relay with internal diodes for coil transient suppression and polarity reversal protection

### INTERNAL CONSTRUCTION

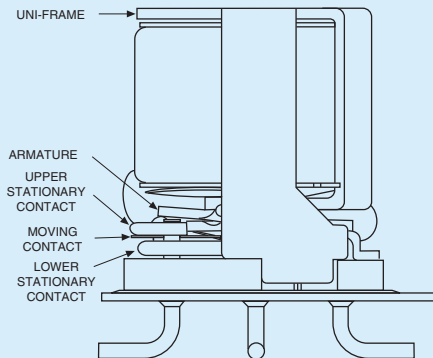

### DESCRIPTION

The Series S134 sensitive surface mount Centigrid® relay is an ultraminiature, hermetically sealed, armature relay. The low profile height (.460") and .100" lead spacing make it ideal for applications where extreme packaging density and/or close PC board spacing are required. The specially formed leads are pre-tinned to make the relays ideal for most types of surface mount solder reflow processes.

The basic design and internal construction are identical to the Series 134 Centigrid® relays, and are capable of meeting Teledyne Relays' T²R® requirements. The following unique construction features and manufacturing techniques provide overall high reliability and excellent resistance to environmental extremes:

- All welded construction.
- Unique uni-frame design providing high magnetic efficiency and mechanical rigidity.
- High force/mass ratios for resistance to shock and vibration.
- Advanced cleaning techniques provide maximum assurance of internal cleanliness.
- Precious metal alloy contact material with gold plating assures excellent high current and dry circuit switching capabilities.

The Series S134D and S134DD relays have internal discrete silicon diodes for coil suppression and polarity reversal protection.

The sensitive surface mount Centigrid® relay has a high resistance coil, thus requiring extremely low operating power (200 mw typical). The advantages of reduced heat dissipation and power supply demands are a plus.

ENVIRONMENTAL AND PHYSICAL SPECIFICATIONS		
Temperature (Ambient)	Storage	-65°C to +125°C
	Operating	-55°C to +85°C
Vibration (General Note 1)		30 g's to 3000 Hz
Shock (General Note 1)		75 g's, 6 msec, half-sine
Acceleration		50 g's
Enclosure		Hermetically sealed
Weight		0.15 oz. (4.3g) max.
Reflow Temperature		260°C max. temp. 1 min. max.

# SERIES S134

## GENERAL ELECTRICAL SPECIFICATIONS (-55°C to +85°C unless otherwise noted) (Notes 2 & 3)

<b>Contact Arrangement</b>	2 Form C (DPDT)	
<b>Rated Duty</b>	Continuous	
<b>Contact Resistance</b>	0.1 ohm max. before life; 0.2 ohm max. after life at 1A/28Vdc (measured 1/8" from header)	
<b>Contact Load Ratings (DC)</b> (See Fig. 2 for other DC resistive voltage/current ratings)	Resistive: 1 Amp/28Vdc Inductive: 200 mA/28Vdc (320 mH) Lamp: 100 mA/28Vdc Low Level: 10 to 50 µA/10 to 50mV	
<b>Contact Load Ratings (AC)</b>	Resistive: 250 mA/115Vac, 60 and 400 Hz (Case undergrounded) 100 mA/115Vac, 60 and 400 Hz (Case grounded)	
<b>Contact Life Ratings</b>	10,000,000 cycles (typical) at low level 1,000,000 cycles (typical) at 0.5A/28Vdc resistive 100,000 cycles min. at all other loads specified above	
<b>Contact Overload Rating</b>	2A/28Vdc Resistive (100 cycles min.)	
<b>Contact Carry Rating</b>	Contact factory	
<b>Coil Operating Power</b>	200 milliwatts typical at nominal rated voltage @ 25°C	
<b>Operate Time</b>	4.0 msec max. at nominal rated voltage @ 25°C	
<b>Release Time</b>	S134 Series: 2.0 msec max. S134D, S134DD Series: 7.5 msec max.	
<b>Contact Bounce</b>	1.5 msec max.	
<b>Intercontact Capacitance</b>	0.4 pf typical	
<b>Insulation Resistance</b>	10,000 megohms min. between mutually isolated terminals	
<b>Dielectric Strength</b>	Atmospheric pressure: 500 Vrms/60Hz	70,000 ft.: 125 Vrms/60Hz
<b>Negative Coil Transient (Vdc)</b>	S134D, S134DD	1.0 max
<b>Diode P.I.V. (Vdc)</b>	S134D, S134DD	100 min.

## DETAILED ELECTRICAL SPECIFICATIONS (-65°C to +125°C unless otherwise noted) (Note 3)

	BASE PART NUMBERS (See Note 10 for full P/N example)	➔	S134-5	S134-6	S134-9	S134-12	S134-18	S134-26
			S134D-5 S134DD-5	S134D-6 S134DD-6	S134D-9 S134DD-9	S134D-12 S134DD-12	S134D-18 S134DD-18	S134D-26 S134DD-26
<b>Coil Voltage (Vdc)</b>	Nom.		5.0	6.0	9.0	12.0	18.0	26.5
	Max.		7.5	10.0	15.0	20.0	30.0	40.0
<b>Coil Resistance (Ohms ±10% @25°C)</b>	S134, S134D		100	200	400	800	1600	3200
	S134DD (Note 4)		64	125	400	800	1600	3200
<b>Coil Current (mAdc @25°C) (134DD Series)</b>	Note 5	Min.	56.8	36.3	18.1	12.5	9.6	7.2
		Max.	78.1	48.9	23.6	16.0	12.2	9.0
<b>Pick-up Voltage (Vdc, Max.)</b>	S134, S134D		3.5	4.5	6.8	9.0	13.5	18.0
	S134DD		3.7	4.8	8.0	11.0	14.5	19.0
<b>Drop-out Voltage (Vdc)</b>	S134, S134D	Min.	0.12	0.18	0.35	0.41	0.59	0.89
		Max.	2.5	3.2	4.9	6.5	10.0	13.0
	S134DD	Min.	0.7	0.8	0.9	1.0	1.1	1.3
		Max.	2.6	3.0	4.5	5.8	9.0	13.0

TYPICAL DC CONTACT RATING (RESISTIVE) (Note 2)

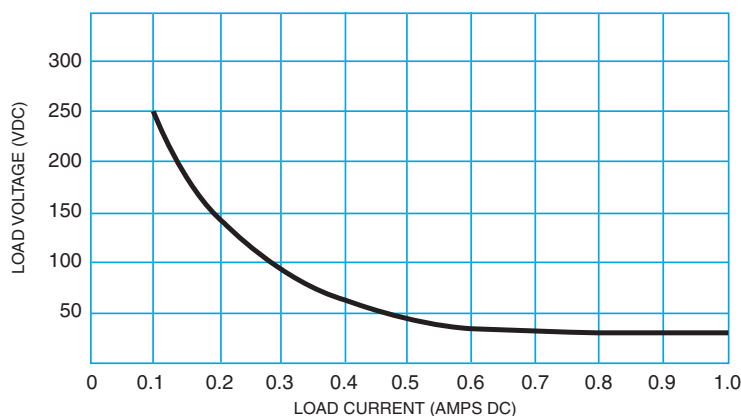
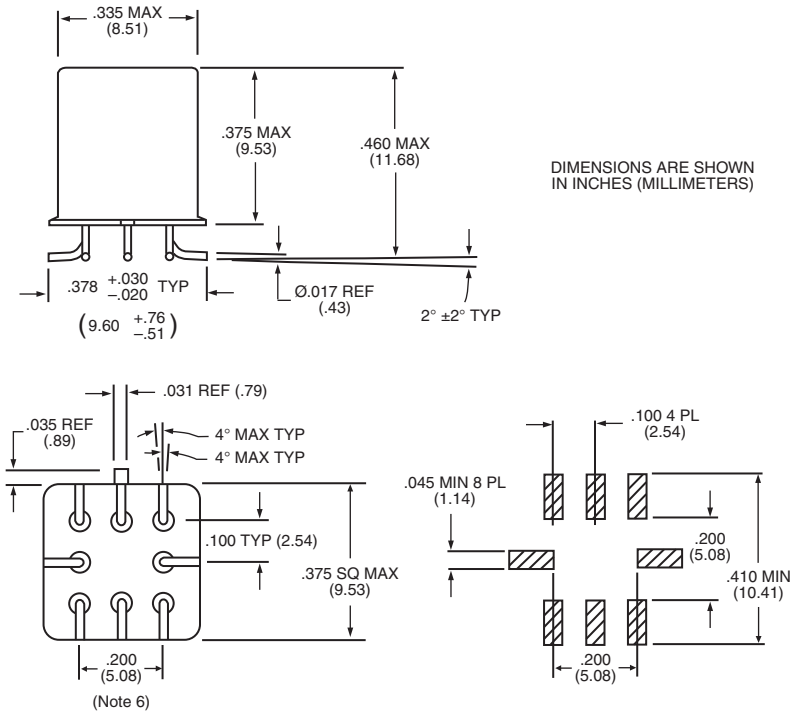

FIGURE 1

**SERIES S134**

**OUTLINE DIMENSIONS AND RECOMMENDED PAD LAYOUT (Notes 7, 8 & 9)**



DIMENSIONS ARE SHOWN IN INCHES (MILLIMETERS)

**TERMINAL LOCATIONS & SCHEMATIC DIAGRAMS**

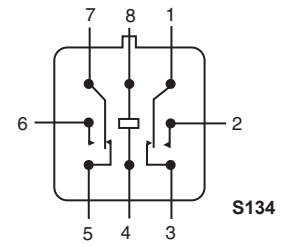

**S134**

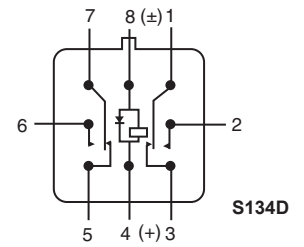

**S134D**

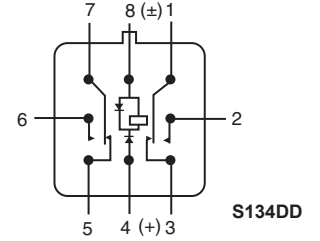

**S134DD**

SCHEMATICS ARE VIEWED FROM TERMINALS

**GENERAL NOTES**

1. Relay contacts will exhibit no chatter in excess of 10 µsec or transfer in excess of 1 µsec.
2. "Typical" characteristics are based on available data and are best estimates. No on-going verification tests are performed.
3. Unless otherwise specified, parameters are initial values.
4. For reference only. Coil resistance not directly measurable at relay terminals due to internal series semiconductor.
5. Measured at nominal voltage for 5 sec. max.
6. Position of leads as they emerge from relay base.
7. Leads will fit noted pad layout with no overhang.
8. Lead ends are coplanar within .008" wide tolerance zone.
9. Terminals coated with SN60 or SN63 solder per QQ-S-571. Kovar exposed at sheared end of leads.
- 10.

**Teledyne Part Numbering System for Surface Mount Relays**

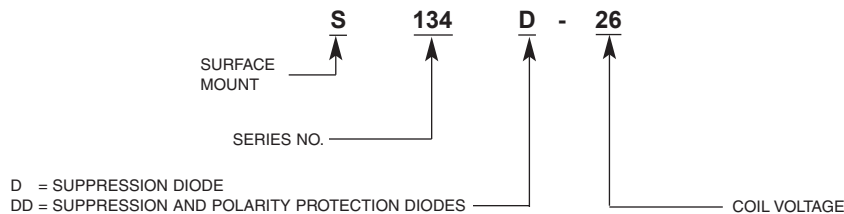

## X-ON Electronics

Largest Supplier of Electrical and Electronic Components

*Click to view similar products for [General Purpose Relays](#) category:*

*Click to view products by [Teledyne](#) manufacturer:*

Other Similar products are found below :

[PCN-105D3MH,000](#) [59641F200](#) [LY1SAC110120](#) [5X827E](#) [5X837F](#) [5X840F](#) [5X842F](#) [5X848E](#) [LY2N-AC120](#) [LY2S-AC220/240](#) [LY2-US-AC120](#) [LY3-US-AC120](#) [LY4F-UA-DC12](#) [LY4F-UA-DC24](#) [LY4F-US-AC120](#) [LY4F-US-AC240](#) [LY4F-US-DC24](#) [LY4F-VD-AC110](#) [LYQ20DC12](#) [M115C60](#) [M115N010](#) [M115N0150](#) [6031007G](#) [603-12D](#) [61211T0B4](#) [61212T400](#) [61222Q400](#) [61243B600](#) [61243C500](#) [61243Q400](#) [61311BOA2](#) [61311BOA6](#) [61311BOA8](#) [61311C0A2](#) [61311COA1](#) [61311COA6](#) [61311F0A2](#) [61311QOA1](#) [61311QOA4](#) [61311T0D6](#) [61311TOA6](#) [61311TOA7](#) [61311TOB3](#) [61311TOB4](#) [61311U0A6](#) [61312Q600](#) [61312T400](#) [61312T600](#) [61313U200](#) [61313U400](#)