

T3DSO4000L-HD

Low Profile Oscilloscopes

Debug with Confidence
500 MHz – 2 GHz
12-bit High Resolution



Tools for Improved Debugging

- | | |
|---|--|
| <ul style="list-style-type: none"> ● Low profile form factor:
4 Channel Model: 1U High Package
8 Channel Model: 2U High Package | <ul style="list-style-type: none"> ✔ Low-profile, high-density package saves rack space for automated test applications. |
| <ul style="list-style-type: none"> ● 12-bit ADC combined with low noise front end provides excellent noise performance | <ul style="list-style-type: none"> ✔ Get better insight on the signal being measured with minimal noise interference. |
| <ul style="list-style-type: none"> ● Robust Connectivity
Built-in web server supports remote control over the LAN port.
Supports SCPI Commands over 1000M LAN (VXI-11/Telnet/Socket) and USBTMC interface | <ul style="list-style-type: none"> ✔ LAN connection provides very fast data acquisition for automated test applications. |
| <ul style="list-style-type: none"> ● Includes Power Analysis and Eye Diagram and Jitter analysis applications as standard | <ul style="list-style-type: none"> ✔ Powerful Data analysis applications as standard. |
| <ul style="list-style-type: none"> ● Includes Serial Bus Decoders for I²C, SPI, UART, CAN, LIN, CAN FD, I²S, MIL- STD- 1553B, FlexRay, SENT & Manchester | <ul style="list-style-type: none"> ✔ Debug serial buses directly in your Oscilloscope at no extra cost. |
| <ul style="list-style-type: none"> ● Math and Measure – 9 basic math functions plus FFT, and 50+ automatic measurement parameters | <ul style="list-style-type: none"> ✔ Extract results from waveforms and measurements. |
| <ul style="list-style-type: none"> ● Optional 16 Channel Logic Probe to enable Mixed Signal functionality | <ul style="list-style-type: none"> ✔ Add mixed signal debugging in your Oscilloscope. |

PRODUCT OVERVIEW

T3DSO4000L-HD Low Profile Oscilloscope features 4-channel (1U High) and 8-channel (2U High) models with analog bandwidth option from 500 MHz to 2 GHz. The low profile form factor combined with 12-bit high resolution ADCs and low noise front end provides an impressive noise performance to cover a wide range of measurement applications. Each model offers a maximum sample rate of 10 GSa/s per channel and a maximum memory depth of 500 Mpts.

It can be remotely controlled over LAN with its built-in web server and a complete SCPI command set over the standard 1000M LAN connection. An impressive display of measurement and math functions along with a built-in 25 MHz arbitrary waveform generator and 16 Channel Logic Analyzer as standard are features of the T3DSO4000L-HD.

Models and Key Specifications

Bandwidth	2 GHz	1 GHz	500 MHz
8 Channel	T3DSO4208L-HD	T3DSO4108L-HD	T3DSO4058L-HD
4 Channel	T3DSO4204L-HD	T3DSO4104L-HD	T3DSO4054L-HD

Model	T3DSO4208L-HD T3DSO4204L-HD	T3DSO4108L-HD T3DSO4104L-HD	T3DSO4058L-HD T3DSO4054L-HD
Channel	8/4 + EXT		
Bandwidth	2 GHz	1 GHz	500 MHz
Sample rate (Max.)	10 GSa/s with ESR per channel		
Memory depth (Max.)	500 Mpts/ch (single-channel) 250 Mpts/ch (dual-channel) 125 Mpts/ch (3 or 4 channels)		
Waveform capture rate (Max.)	Normal mode: 170,000 wfm/s; Sequence mode: 750,000 wfm/s		
Vertical resolution	12-bits		
Trigger type	Edge, Slope, Pulse width, Window, Runt, Interval, Dropout, Pattern, Video, Qualified, Nth edge, Setup/hold, Delay, Serial		
Serial trigger and decode	I ² C, SPI, UART, CAN, LIN, CAN FD, FlexRay, I ² S, MIL-STD-1553B, SENT, Manchester (decode only)		
Measurement	50+ parameters, statistics, histogram, trend, and tracking supported		
Math	4 traces 8 Mpts FFT, +, -, x, ÷, fdt, d/dt, √, Identity, Negation, Absolute, Sign, ex, 10x, ln, lg, Interpolation, MaxHold, MinHold, ERES, Average. Supports formula editor		
Data analysis	Search, Navigate, History, Mask Test, Digital Voltmeter, Counter, Waveform Histogram, Power Analysis, Eye/Jitter Analysis		
Digital channel (optional)	16-channel; maximum sample rate up to 1 GSa/s; record length up to 50 Mpts		
Waveform generator	Single-channel built-in waveform generator, frequency up to 25 MHz, 125 MSa/s sample rate, 16 kpts waveform memory		
I/O	HDMI (1280*800), USB 3.0 Host x2, USB 2.0 Host x2, USB 2.0 Device (USBTMC), 1000M LAN (SCPI over VXI-11, SCPI over Telnet (port:5024), SCPI over Socket (port:5025), micro SD card, External trigger, Auxiliary output (TRIG OUT, PASS/FAIL), 10 MHz In, 10 MHz Out		

PANEL INTRODUCTION



- A Analog Input Connectors** 1 MΩ: ≤ 400 Vpk (DC + AC), DC~10 kHz; 50 Ω: ≤ 5 Vrms, ±10 V Peak
- B Digital Input Connector**
- C USB 3.0 Host Ports** Connect to USB storage devices for data transfer or USB mouse / keyboard for control
- D Probe Compensation / Ground Terminal**
- E Power Standby Button**
- F Acquisition status and LAN status LEDs**
- G Reset for LAN**



- A AC Power Input and Power Switch**
- B SD Card Slot**
- C HDMI Video Output** Connect the port to an external monitor. The resolution is 1280 * 800
- D 1000M LAN Port** Connect the port to the network for remote control
- E USB 2.0 Hosts** Connect with a USB storage device or USB mouse/keyboard
- F USB 2.0 Device** Connects with a PC for remote control
- G Auxiliary Out** Outputs the trigger indicator. When Mask Test is enabled, outputs the pass/fail signal
- H Ext Trigger Input**
- I 10 MHz Out and 10 MHz In**
- J Built-in AWG Output**

FEATURES

Key Features

- 8/4 analog channels + 1 external trigger.
- Analog channel bandwidth: up to 2 GHz; real-time sampling rate of up to 10 GSa/s
- Vertical resolution: 12-bits
- Low noise floor: 153 μ Vrms at full bandwidth of 2 GHz
- New generation of high speed display technology
 - › Waveform capture rates up to 170,000 wfm/s (normal mode), and 750,000 wfm/s (sequence mode)
 - › Supports 256-level intensity grading and color temperature display modes
 - › Memory depth up to 500 Mpts/channel
 - › Digital trigger system
- Intelligent trigger: Edge, Slope, Pulse, Window, Runt, Interval, Dropout, Pattern, Qualified, Nth edge, Setup/hold, Delay and Video (HDTV supported).
- Serial bus triggering and decoder, supports protocols I²C, SPI, UART, CAN, LIN, CAN FD, FlexRay, I²S, MIL-STD-1553B, SENT and Manchester
- Segmented acquisition (Sequence) mode, dividing the maximum record length into multiple segments (up to 80,000), according to trigger conditions set by the user, with a very small dead time between segments to capture the qualifying event
- History waveform record (History) function, the maximum recorded waveform length is 80,000 frames
- Automatic measurements on 50+ parameters, supports statistics with histogram, track, trend, Gating measurement, and measurements on Math, History, Memory and Ref
- 4 Math traces (8 Mpts FFT, addition, subtraction, multiplication, division, integration, differential, square root, etc.), supports formula editor
- Abundant data analysis functions such as Search, Navigate, Digital Voltmeter, Counter, Waveform Histogram, Power Analysis and Eye/Jitter Analysis
- 16 digital channels (optional)
- Built-in 25 MHz function / arbitrary waveform generator with multiple predefined waveforms
- Interfaces include: 4x USB Hosts, USB Device (USBTMC), 1000M LAN (VXI-11/ Telnet/ Socket), micro SD card, Pass/Fail, Trigger Out, HDMI, 10 MHz In, 10 MHz Out
- Built-in web server supports remote control over the LAN port using a web browser. Supports SCPI remote control commands. Supports external mouse and keyboard.

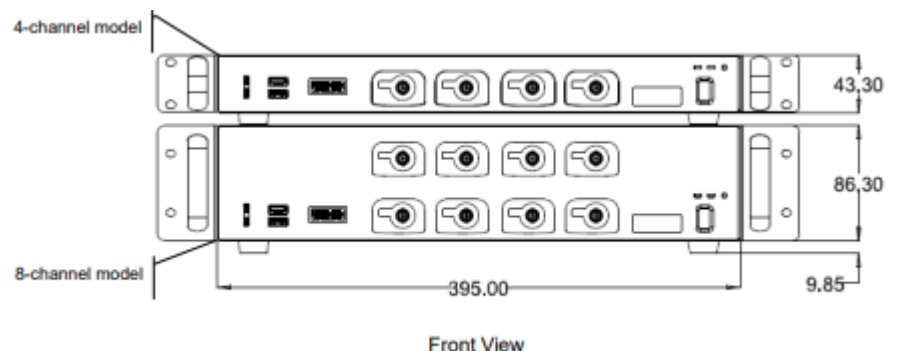
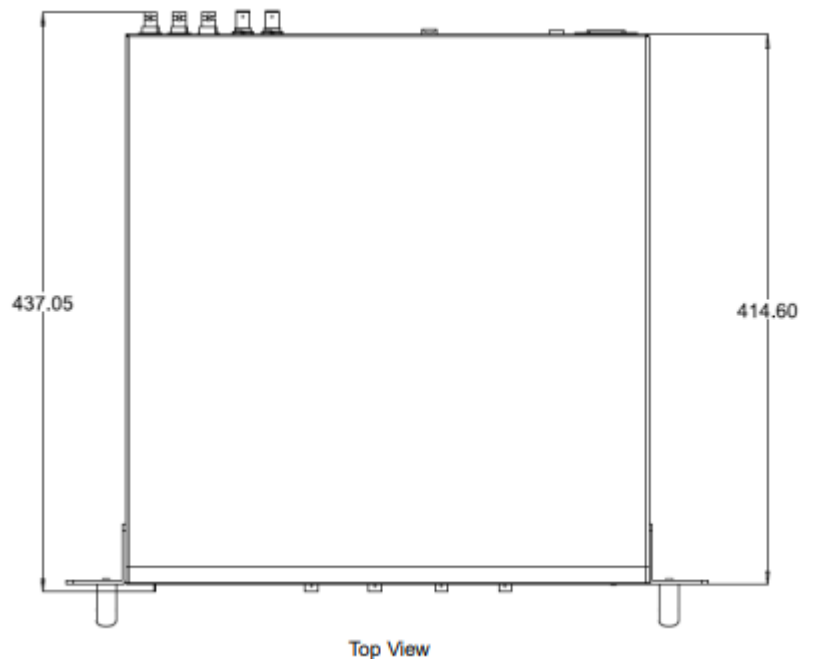

FUNCTIONS AND CHARACTERISTICS

High-resolution to meet high precision test requirements

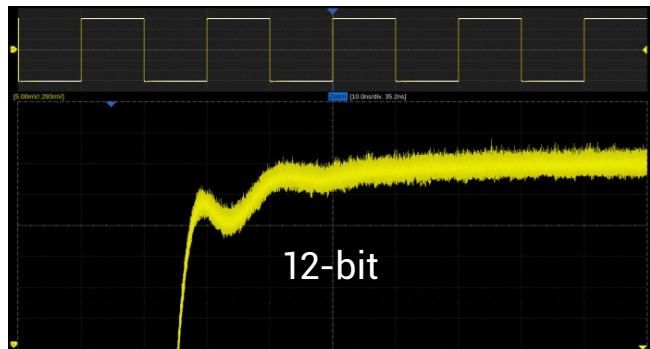
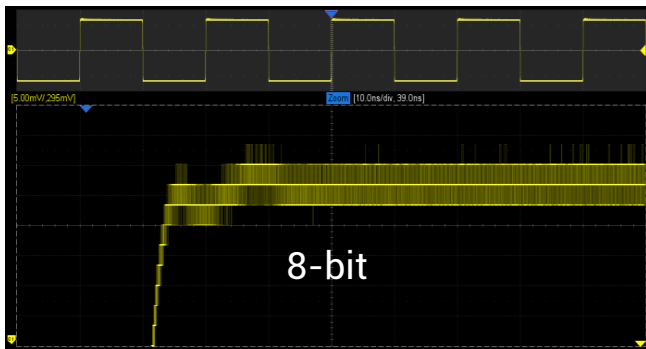

When compared to waveforms acquired and displayed using conventional 8-bit oscilloscopes, waveforms captured with 12-bit technology are cleaner and provides more signal detail. This is helpful for wide dynamic range signals in which a full-scale signal must be acquired while at the same time very small amplitude signal details must be analyzed.

High Performance front-end

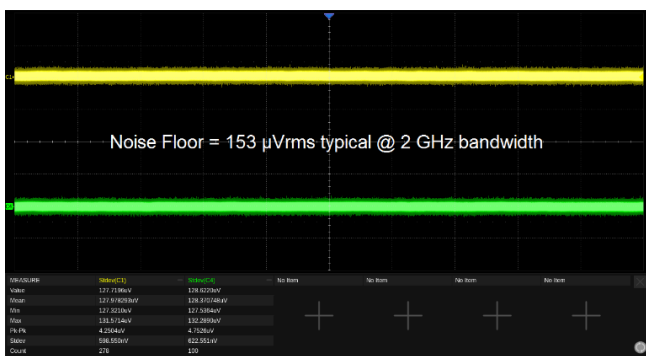

The noise floor value is:

- 153 μ Vrms at full bandwidth of 2 GHz
- 125 μ Vrms at bandwidth of 1 GHz

High Waveform Update Rate

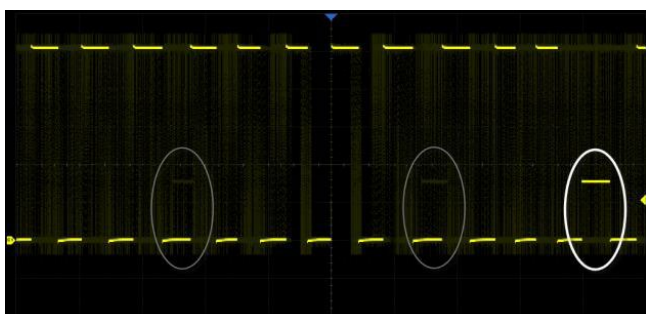

With a waveform update rate of up to 170,000 wfm/s, the oscilloscope can easily capture unusual or low-probability events. In Sequence mode, the waveform capture rate can reach 750,000 wfm/s.

Superb DC Gain Accuracy

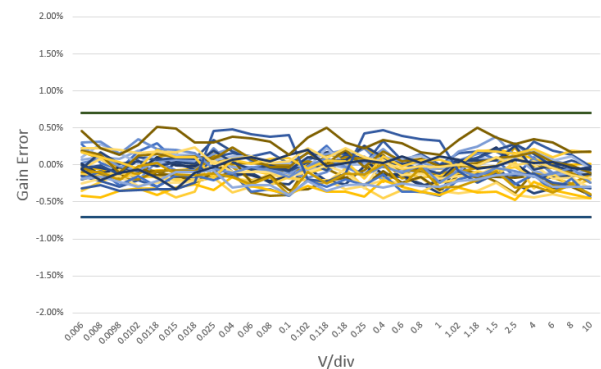

A typical DC Gain Accuracy 0.5 % combined with low noise floor provides the capability to perform sensitive measurement required for wide range of applications.

Deep Record Length

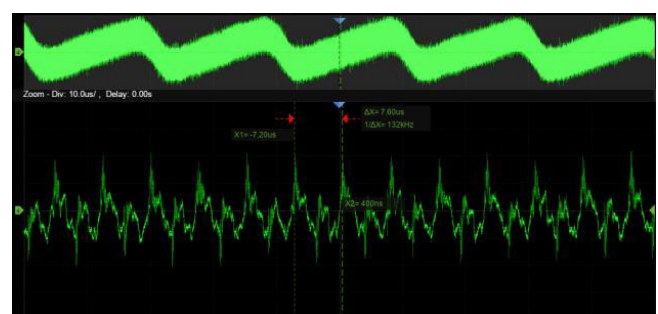

Using a hardware-based Zoom technique and record length of up to 500 Mpts, users can select a slower timebase without compromising the sample rate, and then quickly zoom in to focus on the area of interest.

FUNCTIONS AND CHARACTERISTICS

Multiple Trigger Functions

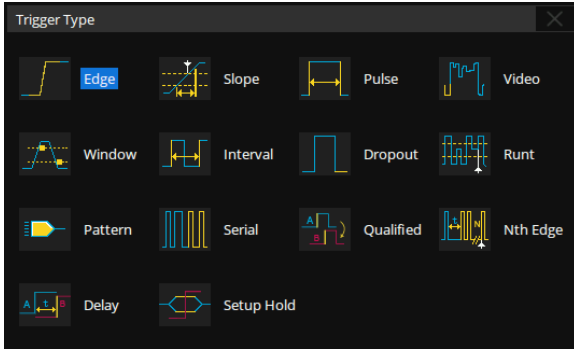

Edge, Slope, Pulse, Video, Windows, Runt, Interval, Dropout, Pattern, Qualified, Nth edge, Setup/ hold, Delay, and serial trigger.

Advanced Math Function

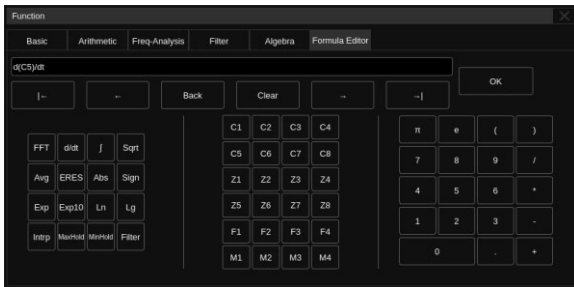

In addition to the traditional (+, -, X, /) operations, FFT, integration, differential, square root, and more are supported. Formula Editor is available for more complex operations. 4 math traces are available.

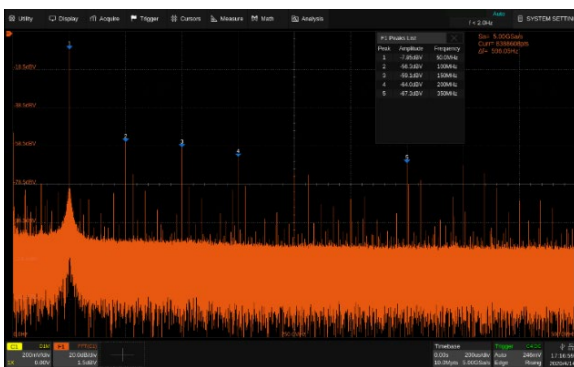

Hardware-accelerated FFT supports up to 8 Mpts operation. This provides high-frequency resolution with a fast refresh rate. The FFT function also supports a variety of window functions so that it can adapt to different spectrum measurement needs. Three modes (Normal, Average, and Max hold) can satisfy different requirements for observing the power spectrum. Auto peak detection and markers are supported.

History Mode



The history function can record up to 80,000 frames of waveforms. The recording is executed automatically so that the customer can playback the history waveforms at any time to observe unusual events and quickly locate the area of interest using cursors or measurements. The failed frames of the Mask Test can be stored as history frames.

Trigger Zone

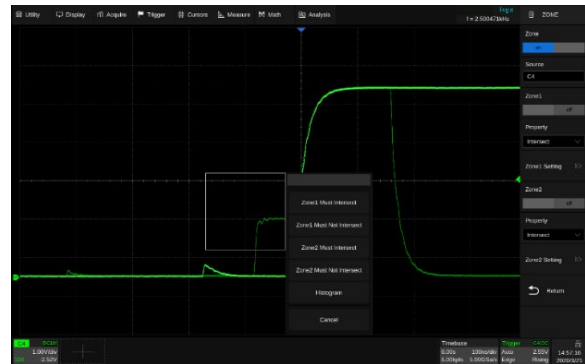

Trigger Zone is available for advanced triggering.

Sequence Mode

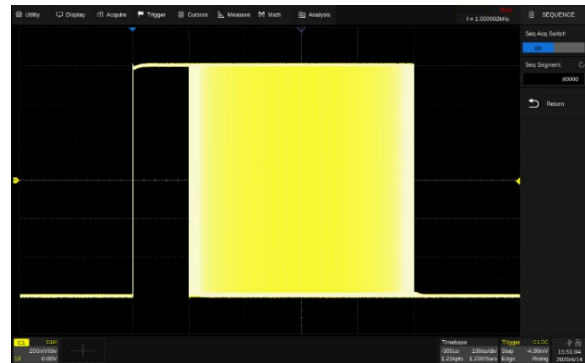

Segmented memory collection will store the waveform into multiple memory segments (up to 80,000) and each segment will store a triggered waveform as well as the dead time information. The interval between segments can be as small as 1.3 μ s. All of the segments can be played back using the History function.

Search and Navigate

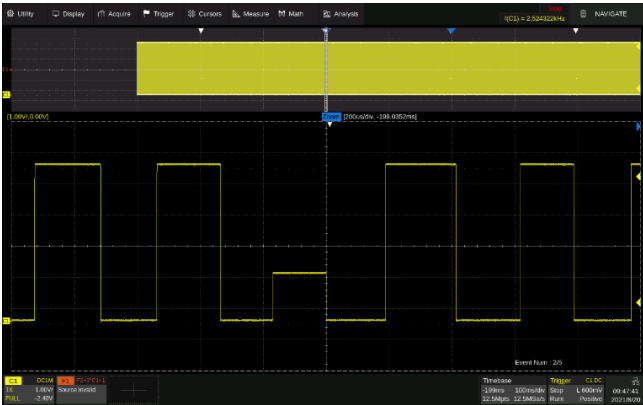

The oscilloscope can search events specified by the user in a frame. Events flagged by the Search can be recalled automatically using Navigate. It can also navigate by time (delay position) and history frames.

Parameter Statistics Function

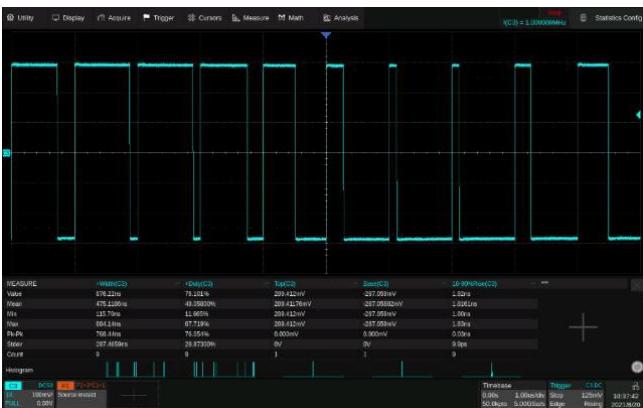

Statistics show the current value, maximum value, minimum value, standard deviation, and mean value of up to 12 parameters simultaneously. A histogram is available to show the probability distribution of a parameter. Trend and Track are available to show the parameter value vs. time.

For horizontal parameters such as period, all results are extracted from a frame, instead of just calculating the first one. This accelerates statistics on horizontal measurements much more and enables distribution observation in a frame using Histogram and Track.

Hardware-based Mask Test Function

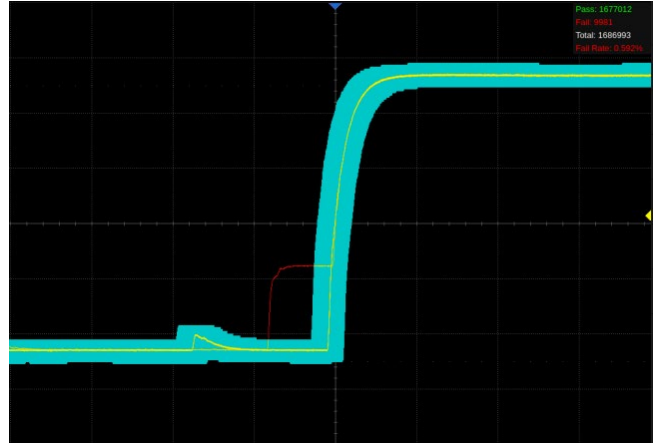

The oscilloscope utilizes a hardware-based Mask Test function, performing up to 18,000 Pass/Fail decisions each second. It is easy to generate userdefined test templates to provide trace mask comparisons, making it suitable for long-term signal monitoring or automated production line testing.

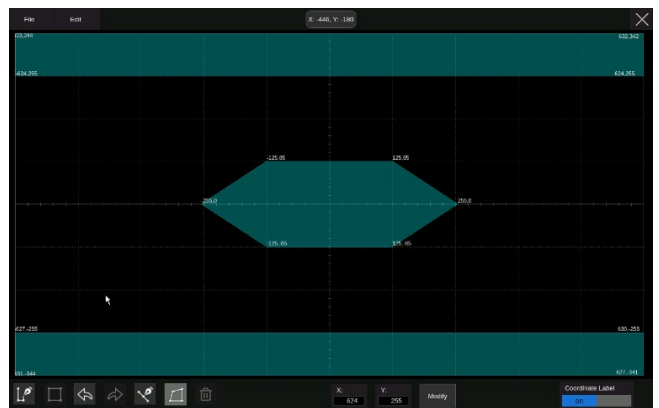

Built-in Mask Editor application helps to create custom masks.

FUNCTION & CHARACTERISTICS

Eye/Jitter Analysis

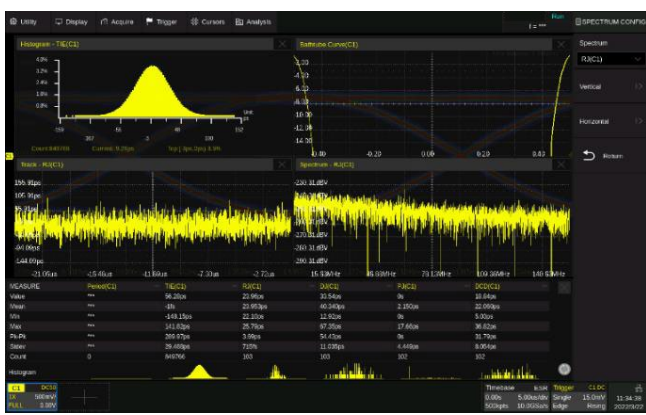
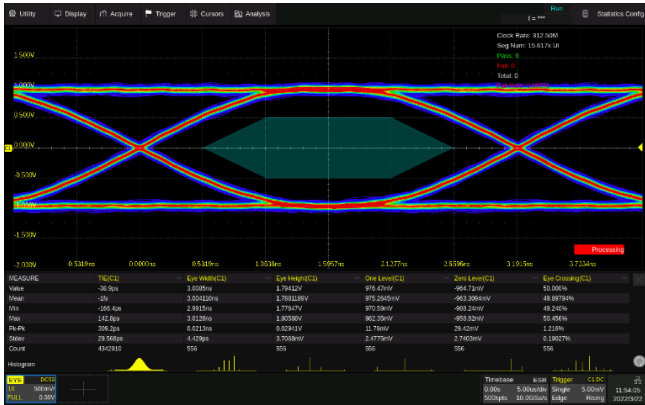

Supports eye diagram and jitter analysis/measurement. It can automatically extract the embedded reference clock from serial data and create an eye diagram. Measurement on multiple eye/jitter parameters is provided and mask testing of eye diagrams is supported.

25 MHz Function/Arbitrary Waveform Generator

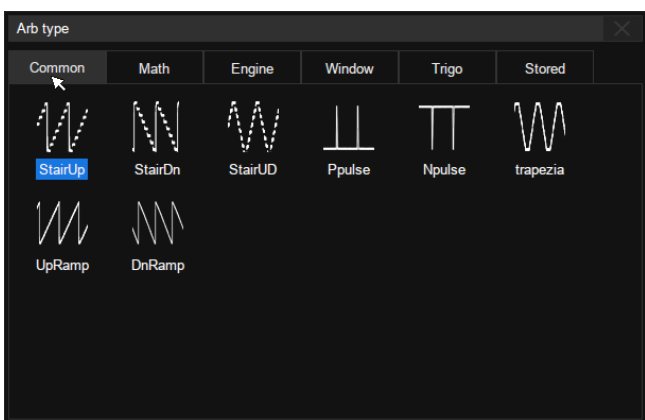

The built-in Function/Arbitrary waveform generator can output waveform with up to 25 MHz frequency and ± 3 V amplitude. Six basic waveforms plus multiple types of arbitrary waveforms are built-in.

Power Analysis



The Power Analysis application provides a full suite of power measurement and analysis tools. These tools enable an improvement in the efficiency of measurements made on switching power supplies and power devices. The Power Analysis application can measure Power Quality, Current Harmonics, Inrush Current, Switching Loss, Slew Rate, Modulation, Output Ripple, Turn On/ Turn Off, Transient Response, PSRR and Efficiency. Each measurement has a help screen showing a connection diagram with notes.

Digital Channels (T3DSO2000-LS)



Four analog channels plus 16 digital channels enable users to acquire and trigger the waveforms and then analyze the pattern, simultaneously with one instrument.

SPECIFICATIONS

Specifications are not guaranteed unless the following conditions are met:

- The oscilloscope calibration period is current
- The oscilloscope has been working continuously for at least 30 minutes at the specified temperature (18 °C – 28 °C)

Acquire (analog)

Sample rate	10 GSa/s with ESR ¹⁾ per channel
Memory depth ^{2) 3)}	500 Mpts/ch (single-channel) 250 Mpts/ch (dual-channel) 125 Mpts/ch (4 channels)
Waveform update rate	Normal mode: up to 170,000 wfm/s Sequence mode: up to 750,000 wfm/s
Intensity grading	256-level
Peak detect	200 ps
Average	4, 16, 32, 64, 128, 256, 512, 1024, 2048, 4096, 8192
ERES	Enhanced bit: 0.5, 1, 1.5, 2, 2.5, 3, 3.5, 4 bit
Sequence	Up to 80,000 segments, interval between triggers = 1.3 µs min.
History	Up to 80,000 frames
Interpolation	sinx/x, x

¹⁾ ESR: Enhanced Sample Rate provides better measurement accuracy by using 2x interpolation

²⁾ In Average and ERES modes, the memory depth is 25 Mpts/ch

³⁾ C1 – C4 as a group and C5-C8 as another group. In a group:

Single-channel: Only one channel is enabled in a group

Dual-channel: Two channels are enabled in a group

Vertical (analog)

Model	T3DSO4208L-HD T3DSO4204L-HD	T3DSO4108L-HD T3DSO4104L-HD	T3DSO4058L-HD T3DSO4054L-HD
Channel	8/4 + EXT		
Resolution	12-bits		
Bandwidth (-3 dB) @ 50 Ω	2 GHz ¹⁾	1 GHz	500 MHz
Rise time @ 50 Ω (typical)	230 ps	350 ps	550 ps
Bandwidth (-3 dB) @ 1M Ω, with probe	500 MHz		
Effective number of bits (ENOB)	8.1 bits	8.3 bits	8.5 bits
Noise Floor ²⁾ (rms, 50 Ω, typ)			
0.5 mV/div – 5 mV/div	153 µV	125 µV	90 µV
10 mV/div	185 µV	130 µV	95 µV
20 mV/div	214 µV	160 µV	115 µV
50 mV/div	427 µV	280 µV	210 µV
100 mV/div	738 µV	465 µV	350 µV
200 mV/div	2.12 mV	1.65 mV	1.10 mV
500 mV/div	4.41 mV	2.75 mV	2.10 mV
1 V/div	7.39 mV	4.70 mV	3.50 mV
Vertical scale range	8 divisions		
Vertical scale (probe 1X)	1 MΩ: 0.5 mV/div – 10 V/div 50 Ω: 0.5 mV/div – 1 V/div		
DC gain accuracy	0.5 mV/div – 4.95 mV/div: ±1.5%; 5 mV/div – 10 V/div: ±0.5%		
DC Offset accuracy	± (1% of the offset setting + 0.5 % of full scale + 0.02 % of max offset + 1 mV)		

¹⁾ The bandwidth is 1 GHz below 2.3 mV/div

²⁾ Take the standard deviation (Stdev)

SPECIFICATIONS

Model	T3DSO4208L-HD T3DSO4204L-HD	T3DSO4108L-HD T3DSO4104L-HD	T3DSO4058L-HD T3DSO4054L-HD
Offset range (probe 1X)	1 M Ω : 0.5 mV/div – 5 mV/div: ± 1.6 V 5.1 mV/div – 10 mV/div: ± 4 V 10.2 mV/div – 20 mV/div: ± 8 V 20.5 mV/div – 100 mV/div: ± 16 V 102 mV/div – 200 mV/div: ± 80 V 205 mV/div – 1 V/div: ± 160 V 1.02 V/div – 10 V/div: ± 400 V 50 Ω : 0.5 mV/div – 5 mV/div: ± 1.6 V 5.1 mV/div – 10 mV/div: ± 4 V 10.2 mV/div – 20 mV/div: ± 8 V 20.5 mV/div – 1 V/div: ± 10 V		
Bandwidth limit	Hardware Bandwidth limit: 20 MHz, 200 MHz		
Low-frequency response (AC coupling -3 dB)	6 Hz (typical)		
Overshoot (100 mV/div, 150 ps edge @ 50 Ω , typical)	15 %	10 %	5 %
Coupling	DC, AC, GND		
Impedance	(1 M Ω \pm 2 %) (20 pF \pm 3 pF) 50 Ω : 50 Ω \pm 2 %		
Max. Input voltage	1 M Ω < 400 Vpk (DC + AC), DC-10 kHz 50 Ω < 5 Vrms, ± 10 V Peak		
SFDR	> 45 dBc		
CH to CH Isolation (@ 50 Ω)	70 dB up to 200 MHz 60 dB up to 500 MHz 50 dB up to 1 GHz 40 dB up to 2 GHz		
Probe Attenuation	1X, 10X, 100X, custom		

Horizontal

Time scale	0.1 ns/div – 1000 s/div	0.2 ns/div – 1000 s/div	0.5 ns/div – 1000 s/div
Range	10 divisions		
Display mode	Y-T, X-Y, Roll		
Roll mode	≥ 50 ms/div		
Skew (CH1 – CH8)	< 100 ps		
Time base Accuracy	± 2 ppm initial (0–50 $^{\circ}$ C); ± 0.5 ppm 1st year aging; ± 3 ppm 20-year aging		

Trigger

Mode	Auto, Normal, Single		
Level	Internal: ± 4.5 div from the center of the screen EXT: ± 0.61 V EXT/5: ± 3.05 V		
Hold off range	By time: 4 ns – 30 s (4 ns step) By event: 1 – 108		
Coupling	CH1 – CH8 DC: Passes all components of the signal AC: Blocks DC components and attenuates signals below 15 Hz LFRJ: Attenuates the frequency components below 2.4 MHz HFRJ: Attenuates the frequency components above 1.3 MHz Noise RJ: Increases the trigger hysteresis EXT DC: Passes all components of the signal AC: Blocks DC components and attenuates signals below 15 Hz LFRJ: Attenuates the frequency components below 2.5 MHz HFRJ: Attenuates the frequency components above 1.3 MHz		
Accuracy (typical)	CH1 – CH8: ± 0.2 div EXT: ± 0.3 div		
Sensitivity		Noise RJ = OFF	Noise RJ = ON
	CH1 ~ CH8:	>10 mV/div:	± 0.26 div
		5 mV/div – 10 mV/div:	± 0.26 div
		≤ 2 mV/div:	± 0.5 div
	EXT:	200 mVpp, DC – 10 MHz 300 mVpp, 10 MHz – bandwidth (300 MHz)	
	EXT/5:	1 Vpp, DC – 10 MHz 1.5 Vpp, 10 MHz – bandwidth (300 MHz)	
Jitter	CH1 – CH8: <100 ps pk-pk EXT: < 200 ps rms		
Displacement	Pre-Trigger: 0–100 % memory Delay-Trigger: 0–5000 div		
Zone	Up to 2 zones Source: CH1 – CH8 Property: Intersect, Not Intersect		
Edge Trigger			
Source	CH1 – CH8 / EXT / (EXT/5) / AC Line / D0 – D15		
Slope	Rising, Falling, Rising & Falling		
Slope Trigger			
Source	CH1 – CH8		
Slope	Rising, Falling		
Limit range	<, >, in range, out of range		
Time range	2 ns – 20 s, Resolution = 1 ns		
Pulse Width Trigger			
Source	CH1 – CH8 / D0 – D15		
Polarity	+wid, -wid		
Limit range	<, >, in range, out of range		
Time range	2 ns – 20 s, Resolution = 1 ns		
Video Trigger			
Source	CH1 – CH8		
Standard	NTSC, PAL, 720p/50, 720p/60, 1080p/50, 1080p/60, 1080i/50, 1080i/60, Custom		
Synchronization	Any, Select		
Trigger Condition	Line, Field		
Window Trigger			
Source	CH1 – CH8		
Window type	Absolute, Relative		

SPECIFICATIONS

Interval Trigger	
Source	CH1 – CH8 / D0 – D15
Slope	Rising, Falling
Limit range	<, >, in range, out of range
Time range	2 ns – 20 s, Resolution = 1 ns
Dropout Trigger	
Source	CH1 – CH8 / D0 – D15
Timeout type	Edge, State
Slope	Rising, Falling
Time range	2 ns – 20 s, Resolution = 1 ns
Runt Trigger	
Source	CH1 – CH8
Polarity	Positive, Negative
Limit range	<, >, in range, out of range
Time range	2 ns – 20 s, Resolution = 1 ns
Pattern Trigger	
Source	CH1 – CH8 / D0 – D15
Pattern Setting	Don't Care, Low, High
Logic	AND, OR, NAND, NOR
Limit range	<, >, in range, out of range
Time range	2 ns – 20 s, Resolution = 1 ns
Qualified Trigger	
Type	State, State with Delay, Edge, Edge with Delay
Qualified Source	CH1 – CH8 / D0 – D15
Edge Trigger Source	CH1 – CH8 / D0 – D15
Nth Edge Trigger	
Source	CH1 – CH8 / D0 – D15
Slope	Rising, Falling
Idle time	8 ns – 20 s, Resolution = 1 ns
Edge Number	1 – 65535
Delay Trigger	
Source A	CH1 – CH8 / D0 – D15
Source B	CH1 – CH8 / D0 – D15
Slope	Rising, Falling
Limit range	<, >, in range, out of range
Time range	2 ns – 20 s, Resolution = 1 ns
Serial Trigger	
Source	CH1 – CH8 / D0 – D15
Protocol	I ² C, SPI, UART, CAN, LIN, CAN FD, FlexRay, I ² S, MIL-STD-1553B, SENT
I ² C	Type: Start, Stop, Restart, No Ack, EEPROM, Address & Data, Data Length
SPI	Type: Data
UART	Type: Start, Stop, Data, Parity Error
CAN	Type: All, Remote, ID, ID+Data, Error
LIN	Type: Break, Frame ID, ID+Data, Error
CAN FD	Type: Start, Remote, ID, ID+Data, Error
FlexRay	Type: TSS, Frame, Symbol, Errors
I ² S	Type: Data, Mute, Clip, Glitch, Rising Edge, Falling Edge
MIL-STD-1553B	Type: Transfer, Word, Error, Timing
SENT	Type: Start, Slow channel, Fast channel, Error

Serial Decoder

Decoders	2
Threshold	-4.1 to 4.1 div
List	1–7 lines
Decoder type	Full duplex
I²C	
Source	CH1–CH8 / D0–D15
Signal	SCL, SDA
Address	7-bit, 10-bit
SPI	
Source	CH1–CH8 / D0–D15
Signal	CLK, MISO, MOSI, CS
Edge Select	Rising, Falling
Chip select	Active high, Active low, Clock timeout
Bit Order	LSB, MSB
UART	
Source	CH1–CH8 / D0–D15
Signal	RX, TX
Data Width	5-bit, 6-bit, 7-bit, 8-bit
Parity Check	None, Odd, Even, Mark, Space
Stop Bit	1-bit, 1.5-bit, 2-bit
Idle Level	Low, High
Bit Order	LSB, MSB
CAN	
Source	CH1–CH8 / D0–D15
LIN	
LIN Version	Ver 1.3, Ver 2.0
Source	CH1–CH8 / D0–D15
Baud Rate	600 bps, 1200 bps, 2400 bps, 4800 bps, 9600 bps, 19200 bps, Custom
CAN FD	
Source	CH1–CH8 / D0–D15
Nominal Baud Rate	10 kbps, 25 kbps, 50 kbps, 100 kbps, 250 kbps, 1 Mbps, Custom
Data Baud Rate	500 kbps, 1 Mbps, 2 Mbps, 5 Mbps, 8 Mbps, 10 Mbps, Custom
FlexRay	
Source	CH1–CH8 / D0–D15
Baud Rate	2.5 Mbps, 5 Mbps, 10 Mbps, Custom
I²S	
Source	CH1–CH8 / D0–D15
Signal	BCLK, WS, DATA
Audio Variant	Audio-I ² S, Audio-LJ, Audio-RJ
Start Bits	0 – 31
Data Bits	1 – 32
MIL-STD-1553B	
Source	CH1–CH8
SENT	
Source	CH1–CH8 / D0–D15
Manchester	
Source	CH1–CH8
Baud Rate	500 bps – 5 Mbps

SPECIFICATIONS

Measurement

Automatic Measurement

Source	CH1 – CH8, D0 – D15, Math, Ref, History, Zoom
Mode	Simple, Advanced
Range	Screen Gated: inside screen, definable with separate Gate cursors
Custom Threshold	Upper, Middle, Lower
No. of Measurements	Display 12 measurements at the same time (Display mode = M2)
Vertical Parameters	Max, Min, Pk-Pk, Top, Base, Amplitude, Mean, Cycle Mean, Stdev, Cycle Stdev, RMS, Cycle RMS, Median, Cycle Median, FOV, FPPE, ROV, RPRE, Level@Trigger
Horizontal Parameters	Period, Frequency, Time@max, Time@min, +Width, -Width, 10-90%Rise time, 90 – 10 %Fall time, Rise time, Fall time, +Burst Width, -Burst Width, +Duty Cycle, -Duty Cycle, Delay, Time@Middle, Cycle-Cycle jitter
Miscellaneous Parameters	+Area@DC, -Area@DC, Area@DC, Absolute Area@DC, +Area@AC, -Area@AC, Area@AC, Absolute Area@AC, Cycles, Rising Edges, Falling Edges, Edges, Positive pulses, Negative pulses, Positive Slope, Negative Slope
Delay Parameters	Phase, FRFR, FRFF, FFFR, FFFF, FRLR, FRLF, FFLR, FFLF, Skew, Tsu@R, Tsu@F, Th@R, Th@F
Statistics	Current, Mean, Min, Max, Sdev, Count, Histogram, Trend, Track
Statistics Count	Unlimited, 1-1024

Cursors

Source	CH1 – CH8, D0 – D15, Math, Ref, Histogram
Type	Manual: Time X1, X2, (X1-X2), (1/ΔT); Vertical Y1, Y2, (Y1-Y2) Track: Time X1, X2, (X1-X2) Measure: Indicates the measurement of a specific parameter

Math

Trace	F1, F2, F3, F4
Source	CH1 – CH8, Z1 – Z8, F1 – F4
Operation	FFT, +, -, x, ÷, ∫dt, d/dt, √, Identity, Negation, x , Sign, ex, 10x, ln, lg, Interpolation, Max hold, Min hold, ERES, Average, Formula Editor
FFT	Length: 8 Mpts, 4 Mpts, 2 Mpts, 1 Mpts, 512 kpts, 256 kpts, 128 kpts, 64 kpts, 32 kpts, 16 kpts, 8 kpts, 4 kpts, 2 kpts Window: Rectangular, Blackman, Hanning, Hamming, Flattop Display: Full Screen, Split, Exclusive Mode: Normal, Max hold, Average Tools: Peaks, Markers

Analysis

Search

Source	CH1 – CH8, History
Mode	Edge, Slope, Pulse, Interval, Runt
Copy setting	Copy from trigger, Copy to trigger

Navigate

Type	Search event, Time, History frame
------	-----------------------------------

Mask Test

Source	CH1 – CH8, Z1 – Z8
Mask creating	Auto (Create mask), Customized (Mask Editor)
Mask test speed	Up to 18,000 frames/s

DVM

Source	CH1 – CH8
Mode	DC mean, DC RMS, AC RMS, Peak-peak, Amplitude
Plot	Bar, Histogram, Trend
Gate	20 ms

Power Analysis

Source	CH1 – CH4
Measure	Power quality, Current Harmonics, Inrush current, Switching loss, Slew rate, Modulation, Output ripple, Turn on/turn off, Transient response, PSRR, Efficiency, SOA

Histogram	
Source	CH1 – CH8
Type	Horizontal, Vertical, Both
Counter	
Source	CH1 – CH8
Frequency resolution	7 digits
Totalizer	Counter on edges, supports Gate and Trigger
Eye Diagram	
Source	CH1 – CH8
Clock recovery	Constant frequency, PLL
Measure	Eye height, "1" level, "0" level, Eye amplitude, Eye width, Eye crossing, Average power, Q factor, TIE
Mask Test	Supported
Jitter Analysis	
Source	CH1 – CH8
Clock recovery	Constant frequency, PLL
Measure	Period, Frequency, +Width, -Width, +Duty cycle, -Duty cycle, Cycle-cycle jitter, Cycle-cycle +width, Cycle-cycle -Width, Cycle-cycle +Duty cycle, Cycle-cycle -Duty cycle, Bit Rate, Unit interval
Jitter decomposition	TIE, RJ, DJ, DCD, DDJ, PJ, TJ@BER Statistics: Histogram, Track, Spectrum

Digital Channels

Max. Sampling Rate	1 GSa/s
Memory Depth	50 Mpts/ch
Min. Detectable Pulse Width	3.3 ns
Level Group	D0 – D7, D8 – D15
Level Range	-10 V – 10 V
Logic Type	TTL, CMOS, LVCMOS3.3, LVCMOS2.5, Custom
Skew	D0-D15: ± 1 sampling interval Digital to Analog: $\pm (1 \text{ sampling interval} + 1 \text{ ns})$

Waveform Generator

Channels	1
Max. Output Frequency	25 MHz
Sampling Rate	125 MSa/s
Frequency Resolution	1 μ Hz
Frequency Accuracy	± 50 ppm
Vertical Resolution	14-bit
Amplitude Range	-1.5 V – +1.5 V (into 50 Ω) -3 V – +3 V (into High-Z)
Waveforms	Sine, Square, Ramp, Pulse, DC, Noise, 45 Arbitrary
Output Impedance	50 $\Omega \pm 2\%$
Protection	Over-voltage protection, Current limit
Sine	
Frequency	1 μ Hz – 25 MHz
Offset accuracy (10 kHz)	$\pm (1\% \cdot \text{offset setting value} + 3 \text{ mVpp})$
Amplitude flatness	± 0.3 dB, compared to 10 kHz, 2.5 Vpp into 50 Ω
SFDR	DC – 1 MHz -60 dBc 1 MHz – 5 MHz -55 dBc 5 MHz – 25 MHz -50 dBc
Harmonic distortion	DC – 5 MHz -50 dBc 5 MHz – 25 MHz -45 dBc

SPECIFICATIONS

Square / Pulse	
Frequency	1 μ Hz – 10 MHz
Duty cycle	1 % – 99 %
Edge	< 24 ns (10 % – 90 %)
Overshoot	< 3% (typical 1 kHz, 1 Vpp)
Pulse width	> 50 ns
Jitter (cycle-cycle)	< 500 ps + 10 ppm
Ramp	
Frequency	1 μ Hz – 300 kHz
Linearity	< 0.1 % of Pk-Pk (typical, 1 kHz, 1 Vpp, 50 % symmetry)
Channels	0 % – 100 %
DC	
Offset range	\pm 1.5 V (into 50 Ω) \pm 3 V (into Hi-Z)
Accuracy	\pm (setting value *1% + 3 mV)
Noise	
Bandwidth (-3 dB)	>25 MHz
Arb	
Frequency	1 μ Hz ~ 5 MHz
Waveform memory	16 kpts
Sample rate	125 MSa/s
Wave import	From EasyWaveX, from U-disk, directly from waveform data of analog channels

I/O

Front	USB 3.0 Host x2, Calibration Signal: 1 kHz, 3 V Square
Rear	USB 2.0 Host x2, USB 2.0 Device, LAN: 10 / 100M / 1000M BaseT (RJ45), Micro SD Card, External Trigger, EXT: \leq 1.5 Vrms, EXT/5: \leq 7.5Vrms, Auxiliary Output: TRIG OUT (3.3 V LVCMOS), PASS/FAIL OUT (3.3 V TTL), HDMI 10 MHz In, 10 MHz Out AWG

Display Setting

Range	8 x 10 grid
Display Type	Dot, Vector
Persistence Time	OFF, 0.1 s, 0.2 s, 0.5 s, 1 s, 5 s, 10 s, 30 s, infinite
Color Display	Normal, Color; Supports customer trace color
Language	Simplified Chinese, Traditional Chinese, English, French, Japanese, German, Spanish, Russian, Italian, Portuguese
Built-in Help System	Simplified Chinese, English



Environmental

Temperature	Operating: 0 °C – 50 °C Non-operating: -30 °C– -70 °C	
Humidity	Operating: 5 % – 90 % RH, 30 °C, degraded to 50 % RH at 40 °C Non-operating: 5 % – 95 %	
Altitude	Operating: ≤ 3,048 m, 25 °C Non-operating: ≤ 12,192 m	
Electromagnetic Compatibility	Meets EMC directive (2014/30/EU), meets or exceeds IEC 61326-1:2012/EN61326-1:2013 (Basic)	
	Conducted disturbance	CISPR 11 / EN 55011 CLASS A group 1 150 kHz – 30 MHz
	Radiated disturbance	CISPR 11 / EN 55011 CLASS A group 1 30 MHz – 1 GHz
	Electrostatic discharge (ESD)	IEC 61000-4-2 / EN 61000-4-2 4.0 kV (Contact), 8.0 kV (Air)
	Radio-frequency electro- magnetic field Immunity	IEC 61000-4-3 / EN 61000-4-3 10 V/m (80 MHz to 1 GHz); 3 V/m (1.4 GHz to 2 GHz); 1 V/m (2.0 GHz to 2.7 GHz)
	Electrical fast transients (EFT)	IEC 61000-4-4 / EN 61000-4-4 2kV (Input AC Power Ports)
	Surges	IEC 61000-4-5 / EN 61000-4-5 1kV (Line to line) 2kV (Line to ground)
	Radio-frequency continuous conducted Immunity	IEC 61000-4-6 / EN 61000-4-6 3 V, 0.15 – 80 MHz
	Voltage dips and interruptions	IEC 61000-4-11 / EN 61000-4-11 Voltage Dips: 0 % UT during 1 cycle; 40 % UT during 10/12 cycles; 70 % UT during 25/30 cycles Voltage interruptions: 0 % UT during 250/300 cycles
	Safety	UL 61010-1:2012/R: 2018-11; CAN/CSA-C22.2 No. 61010-1:2012/A1:2018-11. UL 61010-2-030:2018; CAN/CSA-C22.2 No. 61010-2-030:2018.
RoHS	EU 2015/863	

SPECIFICATIONS

Power Supply	8-channel	4-channel
Input Voltage & Frequency	100 – 240 Vrms 50/60Hz 100 – 120 Vrms 400 Hz	
Power consumption	380 W max., 240 W typical, 8 W typical in standby mode	190 W max., 120 W typical, 4 W typical in standby mode
Mechanical	8-channel	4-channel
Dimensions	Length × Height × Width = 391 mm × 86 mm × 421 mm	Length × Height × Width = 391 mm × 43 mm × 421 mm
Weight	Net Weight 9.1 kg	Net Weight 6.1 kg

T3DSO4000L-HD Probes

Probe type	Model	Picture	Description
Passive	T3PP500		500 MHz bandwidth, 10 MΩ, 10X Probe, 1 supplied per channel. Replacement probe for the T3DSO4000L-HD Low Profile Oscilloscope.
Logic Probe	T3DSO2000-LS		Optional 16 Channel Logic Probe.

Ordering information

Description	2 GHz bandwidth, 5 GSa/s sample rate, 12-Bit, 500 Mpts memory depth, 8-channel	T3DSO4208L-HD
	2 GHz bandwidth, 5 GSa/s sample rate, 12-Bit, 500 Mpts memory depth, 4-channel	T3DSO4204L-HD
	1 GHz bandwidth, 5 GSa/s sample rate, 12-Bit, 500 Mpts memory depth, 8-channel	T3DSO4108L-HD
	1 GHz bandwidth, 5 GSa/s sample rate, 12-Bit, 500 Mpts memory depth, 4-channel	T3DSO4104L-HD
	500 MHz bandwidth, 5 GSa/s sample rate, 12-Bit, 500 Mpts memory depth, 8-channel	T3DSO4058L-HD
	500 MHz bandwidth, 5 GSa/s sample rate, 12-Bit, 500 Mpts memory depth, 4-channel	T3DSO4054L-HD
Standard Accessories	Passive Probe 1/CH	
	USB Cable	
	Power Cord	
	Wireless mouse	
	Quick Start Guide	
	Certificate of Calibration	
Optional Accessories	Rackmount Kit	
	16 Channel MSO Probe	T3DSO2000-LS
	500 MHz Passive Probe, 10:1, 10 MΩ	T3PP500

ABOUT TELEDYNE TEST TOOLS



Company Profile

Teledyne LeCroy is a leading provider of oscilloscopes, protocol analyzers and related test and measurement solutions that enable companies across a wide range of industries to design and test electronic devices of all types. Since our founding in 1964, we have focused on creating products that improve productivity by helping engineers resolve design issues faster and more effectively. Oscilloscopes are tools used by designers and engineers to measure and analyze complex electronic signals in order to develop high-performance systems and to validate electronic designs in order to improve time to market.

The Teledyne Test Tools brand extends the Teledyne LeCroy product portfolio with a comprehensive range of test equipment solutions. This new range of products delivers a broad range of quality test solutions that enable engineers to rapidly validate product and design and reduce time-to-market. Designers, engineers and educators rely on Teledyne Test Tools solutions to meet their most challenging needs for testing, education and electronics validation.

Location and Facilities

Headquartered in Chestnut Ridge, New York, Teledyne Test Tools and Teledyne LeCroy has sales, service and development subsidiaries in the US and throughout Europe and Asia. Teledyne Test Tools and Teledyne LeCroy products are employed across a wide variety of industries, including semiconductor, computer, consumer electronics, education, military/aerospace, automotive/industrial, and telecommunications.

Distributed by:

Teledyne LeCroy (US Headquarters)

700 Chestnut Ridge Road
Chestnut Ridge, NY. USA 10977-6499

Phone: 800-553-2769 or 845-425-2000
Fax Sales: 845-578-5985
Phone Support: 1-800-553-2769
Email Sales: contact.corp@teledynelecroy.com
Email Support: support@teledynelecroy.com
Web Site: <http://teledynelecroy.com/>

Teledyne LeCroy (European Headquarters)

Teledyne GmbH

Im Breitspiel 11c
D-69126 Heidelberg, Germany

Phone: +49 6221 82700
Fax: +49 6221 834655
Phone Service: +49 6221 8270 85
Phone Support: +49 6221 8270 28
Email Sales: contact.gmbh@teledynelecroy.com
Email Service: service.gmbh@teledynelecroy.com
Email Support: support@teledynelecroy.com
Web Site: <http://teledynelecroy.com/germany>

World wide support contacts can be found at:
<https://teledynelecroy.com/support/contact/#>

teledynelecroy.com



© 2024 Teledyne Test Tools is a brand and trademark of Teledyne LeCroy Inc. All rights reserved. Specifications, prices, availability and delivery subject to change without notice. Product brand or brand names are trademarks or requested trademarks of their respective holders.

T3 stands for Teledyne Test Tools.

25jun24

X-ON Electronics

Largest Supplier of Electrical and Electronic Components

Click to view similar products for [Benchtop Oscilloscopes](#) category:

Click to view products by [Teledyne](#) manufacturer:

Other Similar products are found below :

[UTD2072CL](#) [UPO1104](#) [MSO3354E-S](#) [UPO1202CS](#) [RTB-BNDL](#) [UTD2102CL+](#) [MSO3504E](#) [XDS4502](#) [P 1331](#) [UTD2202CEX+](#)
[UTD2152CL](#) [P 1326](#) [UPO1102CS](#) [BK2194](#) [MSO2202-S](#) [MSO2202](#) [MSO2104-S](#) [P 1286](#) [UPO2074E](#) [UPO1204](#) [MSO2102-S](#) [FDS1102](#)
[MSO2204-S](#) [FDS1102A](#) [UTD2052CEX+](#) [MSO2104](#) [T3DSO2204HD](#) [UPO1054](#) [UPO2104](#) [DSO3064A](#) [MSO5062D](#) [CC-650](#) [GDS-2204E](#)
[2555](#) [2557](#) [2568](#) [BK2190E](#) [PICOSCOPE 5244D](#) [PICOSCOPE 5444D](#) [PICOSCOPE 5244D](#) [MSO](#) [DSOX2MSO](#) [DSC-5300](#) [HDO4104A](#)
[HDO4024A](#) [2569-MSO](#) [2190E](#) [DSOX2002A/DSO0000-903](#) [MSOX2024A/DSO0000-903](#) [WAVESURFER 3104Z](#) [MDO-2204EX](#)