



# USER MANUAL

## FLIR IR Spot Thermometers

### TG54 IR Spot Thermometer

### TG56 IR Spot Thermometer with Thermocouple

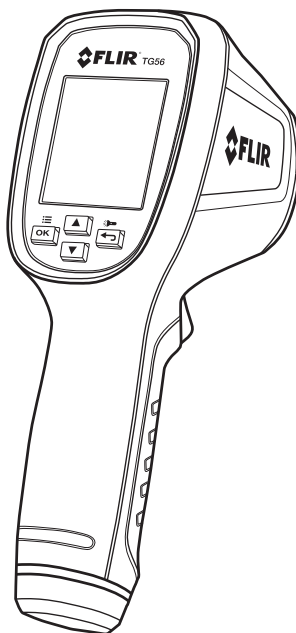
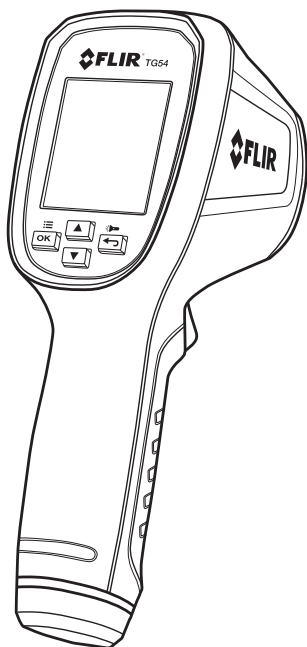

# Table of Contents

---

<b>1</b>	<b>DISCLAIMER</b>	<b>4</b>
1.1	Copyright	4
1.2	Quality Assurance	4
1.3	Documentation	4
1.4	Disposal of Electronic Waste	4
<b>2</b>	<b>SAFETY</b>	<b>5</b>
2.1	International Safety Symbols	5
2.2	Cautions	5
<b>3</b>	<b>INTRODUCTION</b>	<b>6</b>
3.1	Key Features	6
<b>4</b>	<b>DESCRIPTIONS</b>	<b>7</b>
4.1	Rear Description	7
4.2	Front Description	7
4.3	Top Description	7
4.4	Main Display Description	8
4.5	Display Icon Descriptions	9
4.6	Control Buttons and Trigger Descriptions	10
<b>5</b>	<b>OPERATION</b>	<b>11</b>
5.1	Power the meter	11
5.2	Taking Measurements	11
5.3	Distance-To-Spot Ratio	12
5.4	Using the High and Low Alarm	13
5.5	Display Mode Options	13
5.6	Using the Type K Thermometer (TG56 only)	15
<b>6</b>	<b>PROGRAMMING MENU</b>	<b>16</b>
6.1	Programming Menu Overview	16
6.2	Programming Menu Editing	16

6.2.1	Setting the Display Modes	18
6.2.2	Setting the Emissivity	18
6.2.3	Programming High and Low Alarms	19
6.2.4	Setting the Laser Pointer ON or OFF	19
6.2.5	Setting the Temperature Units °C/°F	19
6.2.6	Setting the AUTO Power OFF (APO) Timer	20
6.2.7	Viewing the Help Screen	20
6.2.8	Viewing the Info Screen	20
<b>7</b>	<b>MAINTENANCE</b>	<b>21</b>
7.1	Battery Replacement	21
7.2	Calibration	21
7.3	Cleaning	21
<b>8</b>	<b>SPECIFICATIONS</b>	<b>22</b>
8.1	General Specifications	22
8.2	Environmental Specifications	22
8.3	IR Thermometer Specifications	23
8.4	Laser Specifications	23
8.5	Thermocouple Specifications	23
<b>9</b>	<b>APPENDICES</b>	<b>24</b>
9.1	Emissivity Factors for Common Materials	24
9.2	Infrared Energy and IR Thermometer Theory	25
<b>10</b>	<b>CUSTOMER SUPPORT</b>	<b>26</b>
<b>11</b>	<b>WARRANTY INFORMATION</b>	<b>27</b>
11.1	FLIR Test & Measurement 5 year Limited Warranty	27

# 1 Disclaimer

---

## 1.1 Copyright

© 2015, FLIR Systems, Inc. All rights reserved worldwide. No parts of the software including source code may be reproduced, transmitted, transcribed or translated into any language or computer language in any form or by any means, electronic, magnetic, optical, manual or otherwise, without the prior written permission of FLIR Systems.

The documentation must not, in whole or part, be copied, photocopied, reproduced, translated or transmitted to any electronic medium or machine readable form without prior consent, in writing, from FLIR Systems.

Names and marks appearing on the products herein are either registered trademarks or trademarks of FLIR Systems and/or its subsidiaries. All other trademarks, trade names or company names referenced herein are used for identification only and are the property of their respective owners.

## 1.2 Quality Assurance

The Quality Management System under which these products are developed and manufactured has been certified in accordance with the ISO 9001 standard.

FLIR Systems is committed to a policy of continuous development; therefore we reserve the right to make changes and improvements on any of the products without prior notice.

## 1.3 Documentation

To access the latest manuals and notifications, go to the Download tab at: <http://support.flir.com>. It only takes a few minutes to register online. In the download area you will also find the latest releases of manuals for our other products, as well as manuals for our historical and obsolete products.

## 1.4 Disposal of Electronic Waste



As with most electronic products, this equipment must be disposed of in an environmentally friendly way, and in accordance with existing regulations for electronic waste. Please contact your FLIR Systems representative for more details.

## 2 Safety

---

### 2.1 International Safety Symbols



This symbol, adjacent to another symbol or terminal, indicates the user must refer to the manual for further information.

### 2.2 Cautions

- Improper use of this device can damage the meter.
- Please read and understand all of the information provided in this User Guide and other included documentation before use.
- Use caution when the Class 1 Laser pointer is on. Do not point the beam toward anyone's eye or allow the beam to strike the eye from a reflective surface.
- Refer to the specifications section for detailed information on the Laser characteristics.

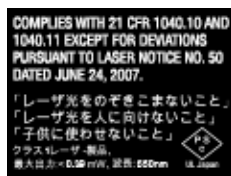

IEC 60825-1 Ed. 2 (2007)

**CAUTION:** Use of controls or adjustments or performance of procedures other than those specified herein may result in hazardous radiation exposure.

## 3 Introduction

---

Thank you for selecting the FLIR IR Thermometer. This device is shipped fully tested and calibrated and, with proper use, will provide years of reliable service. Please visit our support website [www.flir.com/testwarranty](http://www.flir.com/testwarranty) to register the device, to check for the latest version of this User Guide, to view product updates, and to contact Customer Support.

### 3.1 Key Features

- Intuitive and fully programmable IR Spot Thermometer
- Quick boot time, one second approximately
- Bright, easy-to-read graphical color display
- Laser Pointer for targeting accuracy
- 30:1 (TG56) and 24:1 (TG54) Distance to Spot ratio
- Easy-to-use programming settings menu
- Quick emissivity selection with four presets and a custom mode. Preset emissivity icons include visual surface 'texture' examples for convenience.
- Color-coded High and Low Alarm functions
- MIN, MAX, Average, Delta, and 3-reading display modes
- Type K thermocouple thermometer input on the TG56
- Programmable Auto Power OFF feature
- Rugged industrial design
- Lanyard on handle
- Portable and battery operated
- Tool-less battery compartment (twist-off end cap)

## 4 Descriptions

### 4.1 Rear Description

1. Color graphical display
2. Up arrow button
3. MENU/OK button
4. Down arrow button
5. BACK/Work light button
6. Battery compartment (internal)
7. Twist-off end cap to access batteries

**Fig 4-1 Rear View**

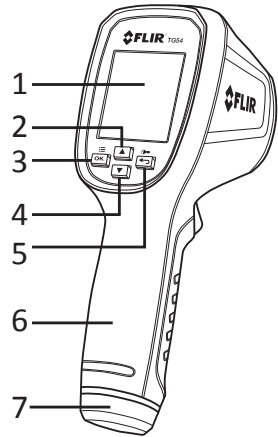

### 4.2 Front Description

1. Laser pointer lens
2. Work lights
3. IR Thermometer lens
4. Measurement trigger
5. Lanyard attachment eyehole

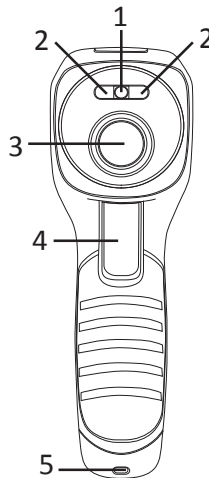

**Fig 4-2 Front View**

### 4.3 Top Description

1. Informational text and illustrations
2. Type K thermocouple input jack (TG56)

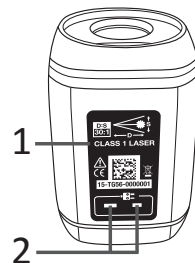

**Fig 4-3 Top View**

## 4.4 Main Display Description

### 4.4.1 Main Display Screen (TG54)

1. Laser pointer active
2. Trigger pressed (scan mode)
3. Mode icon area (three-reading mode shown)
4. Alarm icon area (dual alarm mode shown)
5. Work light active
6. Battery status
7. Emissivity setting (textured preset icon shown)
8. Current reading icon
9. Second most recent reading icon
10. Third most recent reading icon
11. Temperature unit
12. Current reading digits
13. Second most recent reading digits
14. Third most recent reading digits

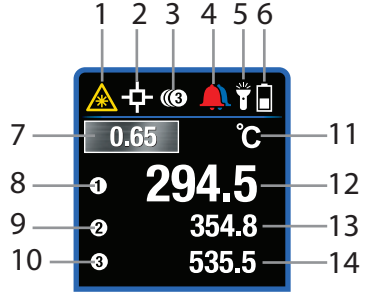

Fig 4-4 Main Display Screen (TG54)

### 4.4.2 Main Display Screen (TG56)

1. Laser pointer active
2. Trigger pressed (scan mode)
3. Mode icon area (thermocouple mode shown)
4. Alarm icon area (dual alarm shown)
5. Work light active
6. Battery status
7. Emissivity setting
8. Thermocouple attached to meter
9. Delta symbol (Max minus Min)
10. Temperature unit
11. Current reading digits
12. Thermocouple reading digits
13. Delta (Max minus Min) value

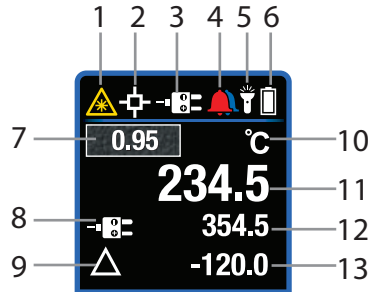



Fig 4-5 Main Display Screen (TG56)

**Note:** Several display icons are not represented in Figs 4-4 and 4-5. However, the icons not shown are covered in Section 4.5, *Display Icon Descriptions*, and elsewhere in this Guide where applicable.



## 4.5 Display Icon Descriptions

**Fig 4-6 Display Icon Table**

	Laser pointer active		Temperature units
	Scan mode (trigger pulled)		Temperature units
	Programming menu alarm icon		Reading 1 in three-reading mode
	Dual High/Low Alarm		Reading 2 in three-reading mode
	High Alarm		Reading 3 in three-reading mode
	Low Alarm		Thermocouple attached (TG56)
	Work light active		Delta mode (MAX minus MIN)
	Full battery power		MIN reading
	Low battery power		MAX reading
	Emissivity 0.65 preset		Average Reading
	Emissivity 0.75 preset		MIN MAX display mode icon
	Emissivity 0.85 preset		Three-reading display mode
	Emissivity 0.95 preset (default)		HOLD mode (trigger released)
	Custom Emissivity in Programming menu		Programming menu icon

## 4.6 Control Buttons and Trigger Descriptions

The TG Series has four (4) control buttons located directly below the display, in addition to the trigger.

**Hint:** Use the thumb for button control and the index finger for trigger control.

**BACK / Work Light Button** 

Long-press to activate/deactivate Work light; Short-press to exit a Programming menu screen

**OK/MENU BUTTON** 

Long-press to access the Programming menu; short-press to confirm/open a menu parameter, and toggle/select a menu option

**UP/DOWN ARROW NAVIGATION BUTTONS** 

Scroll the selections in the Programming menu

Steps through the three display modes (shortcut that permits display mode changes without having to access the Programming menu); see Section 5.5, *Display Mode Options*, for more information

### TRIGGER

Pull and hold the trigger for one second to power ON and take measurements

Release the trigger to freeze the displayed reading (the meter switches off automatically after 5, 10, or 20 seconds; the time can be set in the Programming menu, see Section 6)



## 5 Operation

---

### 5.1 Power the meter

1. Pull and hold the trigger for one second to switch the meter ON and begin scanning surface temperatures.
2. The TG Series is powered by three (3) 1.5V 'AAA' batteries. Batteries are located in the meter (twist off the handle cap to release the battery holder). Refer to Section 7, *Maintenance*, for more detail.
3. The Battery status icon  is shown on the upper right side of the display. The status icon shows full white when 100% powered and darkens as battery power weakens. The battery status icon appears empty (fully dark) when the batteries require changing. Note that temperature readings displayed while the battery symbol is empty will be accurate. Accuracy is assured up until the meter switches OFF.
4. The TG Series has a programmable APO (Auto Power OFF) feature where it automatically shuts off after the trigger is released (after 5, 10, or 20 seconds). Please refer to Section 6, *Programming Menu*, for instructions on setting the APO time.

### 5.2 Taking Measurements

1. Begin by pulling and holding the trigger for one second.
2. While holding the trigger, scan the surface(s) under test. Use the Laser pointer as a guide. Notice that while the trigger is pulled the display shows the scanning icon  and laser pointer icon .
3. View the temperature reading and other information on the display while scanning. If the measurement exceeds the published range, the display will indicate 'OL'. Read Section 4.4, *Main Display Descriptions*, and Section 4.5, *Display Icon Descriptions*, for reference.
4. To set the temperature units ( $^{\circ}\text{C}/^{\circ}\text{F}$ ) please refer to Section 6, *Programming Menu*.
5. When the trigger is released, the scanning and laser icons are replaced by the  (HOLD) icon and the displayed temperature reading is held for a programmable period of time (5,

10, or 20 seconds), after which the meter switches off automatically. To set the Auto Power OFF period please refer to Section 6, *Programming Menu*.

- The laser pointer targets the measurement 'spot'. The Laser pointer can be deactivated in the Programming menu.
- At this point it is important to read Section 9.2, *Infrared Energy and IR Thermometer Theory*, and Section 5.3, *Distance-To-Spot Ratio*.

### 5.3 Distance-To-Spot Ratio

#### The TG54 Distance-to-Spot ratio (D:S) is 24:1

From a distance of 24" the TG54 measures the average temperature of a spot 1" in diameter. From a distance of 48" the spot diameter is 2" and from a distance of 72" the spot diameter is 3". The temperature is shown at the center of the display. Refer to Figs. 5-1 (a) below for illustrative examples of Distance to Spot ratio.

#### The TG56 Distance-to-Spot ratio (D:S) is 30:1

From a distance of 30" the TG56 measures the average temperature of a spot 1" in diameter. From a distance of 60" the spot diameter is 2" and from a distance of 90" the spot diameter is 3". The temperature is shown at the center of the display. Refer to Figs. 5-1 (b) below for illustrative examples of Distance to Spot ratio.

**Fig 5-1 (a) TG54 Distance to Spot ratio 24:1**

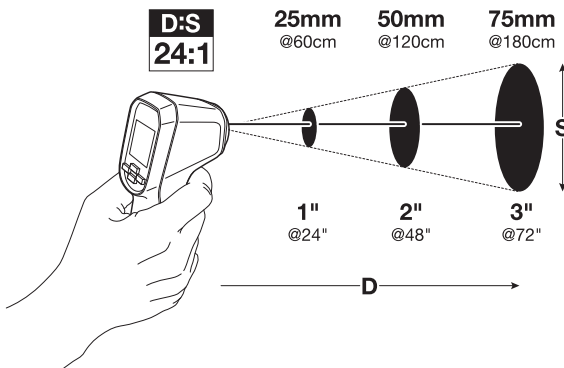

**Fig 5-1 (b) TG56 Distance to Spot ratio 30:1**

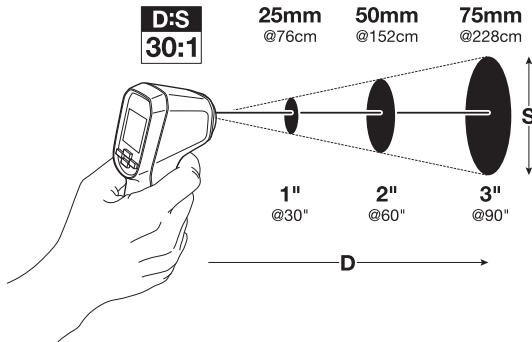

## 5.4 Using the High and Low Alarm

The High and Low Alarm features allows the user to set High only, Low only, or combination High and Low Alarm thresholds that, when exceeded, provide visual alerts.

When alarms are set, the display shows the High alarm icon in red 🔔, the Low alarm in blue 🔔, or the combination High/Low Alarm icon in red and blue 🔔.

Program High, Low, or combination High/Low alarm in Section 6, *Programming Menu*.



The meter will alert the user when an alarm threshold has been triggered by changing the color of the temperature reading digits (red for high alarm trip and blue for low alarm trip).

If the alarm is turned off (🔕 selection in the Programming menu), the alarm function is deactivated and the alarm bell icons will not appear on the main display screen.



## 5.5 Display Mode Options

There are three (3) display mode variations, explained in the next sections. To select a display mode please refer to Section 6, *Programming Menu*, or use the 'shortcut' by simply pressing the arrow buttons in the normal operating mode to step through the modes.



### 5.5.1 MIN-MAX Display Mode

- In MIN-MAX mode the highest and lowest readings recorded, since the trigger was pulled, are displayed along with the real-time reading. When the trigger is released the MIN-MAX and real time readings are held until the meter automatically switches off.
- When MIN-MAX display mode is selected, the MIN-MAX display mode icon  is shown on the display near the middle of the top row of icons.
- The reading next to the MAX icon  is the maximum reading and the reading next to the MIN icon  is the minimum reading. The real-time reading is shown in its usual center location (larger digit size).

### 5.5.2 Average/Delta Display Mode

- In Average/Delta mode the meter shows the average temperature reading, the real-time temperature reading, and the Delta (difference between MAX and MIN) value.
- When the meter is set to the Average/Delta display mode, the delta  icon is shown on the display near the middle of the top row of icons.
- The average reading is shown next to the average icon  and the MAX minus MIN reading is shown next to the second delta symbol  located on the lower half of the display. The real-time reading is shown in its usual center location.
- While the trigger is pulled the meter calculates a continuous running average, taking 10 readings per second (sample rate of 10Hz) up to a maximum of 10 minutes (6000 data points). When the trigger is released the running average is reset.



### 5.5.3 Three-reading Display Mode

- In three-reading mode the meter shows the three most recent readings on one screen. See Fig. 4-4.
- The current reading is shown in the center, the 2<sup>nd</sup> most recent reading is preceded by the  icon, and the third most recent reading is preceded by the  icon.
- The readings at these positions change each time the trigger is released to capture newer readings. In addition, if the color of the digits change (because an alarm condition is met), the color stays with the digits as they move from reading 1 through reading 3.
- When the three-reading display mode is selected, the  icon is shown on the display near the middle of the top row of icons.

## 5.6 Using the Type K Thermometer (TG56 only)

A Type K thermocouple thermometer jack is provided at the top of the TG56. The thermocouple plug has a wide and a thin connecting blade, please insert the thermocouple carefully, in the correct orientation; do not force it into the jack.

When a thermocouple is connected, the temperature of the surface in which the thermocouple is touching is displayed (next to the  icon) along with the IR temperature reading.

The display mode area of the screen (middle of top row of icons) shows the thermocouple  icon when a thermocouple is connected. The difference between the IR reading and the thermocouple reading is displayed next to the delta icon .

When a thermocouple is connected to the meter other operational modes are not available.

### 5.6.1 Using the Type K Thermometer to set Emissivity

1. Measure the surface of the object under test with the IR Thermometer.
2. Measure the same surface with the Type K thermocouple thermometer.
3. Note the difference (delta) between the two readings.
4. Now adjust the Emissivity in the Programming menu (Section 6) so that the IR thermometer reading matches the Type K thermometer reading.
5. When this is accomplished the emissivity setting is correct for the surface in question.

#### Thermocouple notes:

- *The supplied general purpose thermocouple is not rated for the entire measurement range of the meter. The thermocouple can be damaged if temperature outside its specified range is measured. In all cases, please use a thermocouple that is rated for the intended application only. Refer to the specifications section of this User Manual for meter temperature and thermocouple temperature ranges.*
- *The accuracy characteristics of the thermocouple probe should be added to the accuracy specification of the meter when interpreting thermocouple readings.*
- *The IR thermometer averages a larger area than the thermocouple probe, thus the emissivity adjustment procedure in Section 5.6.1 is an approximation.*









## 6 Programming Menu

---

### 6.1 Programming Menu Overview















The programming menu allows the user to configure the TG Series in a variety of ways. Refer to the Table in Fig. 6-1 below and the subsequent sections for specific information on Programming menu editing. Menu changes remain saved even when the meter is powered down.

### 6.2 Programming Menu Editing

1. Pull the meter trigger for one second to power the meter.
2. Press and hold Menu  to enter the Programming Menu. The menu icon  will appear on the upper left hand corner.
3. Use the arrow buttons to scroll through the menu items and pages (not all menu items can be displayed on one page; use the arrow buttons to scroll through pages).
4. The current option will be highlighted.
5. There are four types of menu items:
  - a. Items that can be toggled with the Menu button (two-option items); these are Laser ON/OFF and Temperature Units °C/°F.
  - b. Items that can be set by repeated presses of the Menu button; these are Display mode  and APO  menu items.
  - c. Items that can be viewed by pressing Menu (Info  and Help  screens)
  - d. Items that can be opened by pressing the Menu button for further editing steps (Emissivity  and Alarm  modes)
6. Each menu item is detailed in the following sections.







**Fig 6-1 Programming Menu Overview**

<b>Menu Parameters</b> (press and hold MENU to access the list)	
<b>Icon</b>	<b>Description</b>
	<b>Display modes</b> (use the menu button to step through modes)
	MIN MAX: Highest/lowest temperature readings are shown
	Average temperature reading and delta (Max minus Min) shown
	Three-reading mode: Three most recent readings are shown
	This icon is shown when a thermocouple is connected (TG56)
	<b>Emissivity:</b> Select a preset (0.95, 0.85, 0.75, 0.65) or set a custom emissivity value at the custom emissivity icon 
	<b>Alarm Modes:</b> Program OFF, Low, High, or Low/High Alarms
	<b>Laser Pointer:</b> ON/OFF (use MENU button to toggle)
	<b>Temperature Units:</b> °C/°F (use MENU button to toggle)
	<b>Auto Power OFF (APO) options:</b> 5, 10, and 20 seconds
	<b>Help screen:</b> Contact and other useful information
	<b>Info Screen:</b> View Firmware version, Calibration date, and Laser information.
<b>Navigation Icons</b> (use arrow buttons to scroll)	
	Prompts the user to scroll up to other menu items
	Prompts the user to scroll down to other menu items

## 6.2.1 Setting the Display Modes

Press and hold Menu to access the Programming menu and scroll to the Display Mode icon

. Use the Menu button to select the desired mode:





1. MIN-MAX : Highest and lowest temperature readings are shown.
2. Average mode : Average temperature reading and delta (Max minus Min) shown.
3. Three-reading mode : Three most recent readings are shown.

Refer to Section 5, *Operation*, for more information on Display mode operation.

When a thermocouple is inserted (TG56 only) the display mode menu shows the thermocouple icon  and all other functions are locked until the thermocouple is removed.









## 6.2.2 Setting the Emissivity

The emissivity is adjustable in 0.01 steps from 0.10 to 0.99; the default value is 0.95. Refer to the Appendix for a list of common materials and their respective Emissivity factors.



1. Press and hold Menu  to access the Programming menu and use the arrows to scroll to the emissivity icon .
2. Press Menu to open the item.
3. EMISSIVITY PRESETS: Use the arrow buttons to scroll to one of the preset emissivity factors (0.95, 0.85, 0.75, or 0.65) and then press Menu to confirm. The meter will save the setting and return to the Programming Menu.
4. CUSTOM EMISSIVITY: Use the arrow buttons to scroll to the Custom Emissivity icon  and press Menu. Use the arrow buttons to select the emissivity (0.10 to 0.99) and then press Menu to confirm.
5. Press the Back  button to return to the Programming menu.
6. Use the arrow buttons to select another menu item or press  to return to the normal operating mode.
7. In the normal operating screen the emissivity is shown in a textured box when a preset emissivity is used (otherwise the emissivity value is shown without a textured box). The texture of the preset box is a simulation of a surface that would have an emissivity close to the preset value.

### 6.2.3 Programming High and Low Alarms



Set the alarms off (grey circular icon), set only a High (red) or Low (blue) alarm, or set both a High and a Low (red and blue) alarm.

1. Press and hold Menu to access the Programming menu and scroll to the Alarm icon .
2. Press Menu to open the item and use Menu again to select OFF , High , Low , or High/Low .
3. If OFF  is selected, press  to return to the Programming menu.
4. For all other selections, scroll down to the alarm threshold field and set the High, Low, or High and Low (combination) alarm setpoints. For example, if Low alarm is selected:
  - a) Use the arrow button to scroll down to the alarm threshold digits and press Menu.
  - b) Use the arrow buttons to select the desired Low alarm threshold.
  - c) Press Menu to confirm and press  to return to the Programming menu
5. Follow the steps above to program the other alarm modes. Note that the High alarm threshold cannot be set lower than the Low alarm threshold and vice versa.
6. Refer to Section 5, *Operation*, for more information on Alarm operation.

### 6.2.4 Setting the Laser Pointer ON or OFF



1. Press and hold Menu and use the arrow buttons to scroll to the Laser Pointer  icon.
2. Use the Menu button to toggle the laser pointer ON/OFF.
3. When selection is complete, use the arrow buttons to scroll to another menu item or press  to return to the normal operating mode.

### 6.2.5 Setting the Temperature Units °C/°F

1. Press and hold Menu and use the arrow buttons to scroll to the units icon .
2. Use the Menu button to toggle the Temperature units.
3. When selection is complete, use the arrow buttons to scroll to another menu item or press  to return to the normal operating mode.



## 6.2.6 Setting the AUTO Power OFF (APO) Timer

After a measurement is taken and the trigger is released, the meter freezes the reading on the display for a period of time before automatically switching off. This APO time can be set to 5, 10, or 20 seconds.

1. Press and hold Menu and use the arrow buttons to scroll to APO .
2. Use the Menu button to select 5, 10, or 20 seconds.
3. When selection is complete, use the arrow buttons to scroll to another menu item or press  to return to the normal operating mode.





## 6.2.7 Viewing the Help Screen

From the Help screen in the Programming menu the user can view FLIR contact information and other useful data.

1. Press and hold Menu and use the arrow buttons to scroll to the Help icon .
2. Press Menu to open the item.
3. View the information.
4. Press  to return.

## 6.2.8 Viewing the Info Screen

From the Information screen in the Programming menu the user can view the meter's firmware version and calibration date.

1. Press and hold Menu and use the arrow buttons to scroll to the Information  icon.
2. Press Menu to open the item.
3. View the firmware revision , calibration date , and Laser information .
4. Press  to return.

## 7 Maintenance

---

### 7.1 Battery Replacement

- The TG Series is powered by three (3) 1.5V 'AAA' batteries.
- The batteries are located in a tray housed inside the meter handle. To access the battery tray, unscrew the cap at the bottom of the meter handle.
- Slide the battery tray out of the handle, noting the tray orientation.
- Replace the batteries observing correct polarity.
- Slide the battery tray back into the handle in the original orientation.
- Screw the cap back onto the handle.

### 7.2 Calibration

The meter is calibrated at the factory prior to shipment. If calibration is required please contact a local FLIR service center. The TG Series is not user-serviceable and should only be calibrated by trained, qualified FLIR personnel.

### 7.3 Cleaning

Wipe the housing with a dry or damp cloth as needed. Use a high quality lens wipe to remove dirt or smudges from the meter lenses and display window. Please do not use abrasives or solvents to clean the meter housing, lenses, or display window.

## 8 Specifications

---

### 8.1 General Specifications

Display	1.45" Color TFT
Display resolution	128 (W) x 128 (H) pixels
Battery power	Three (3) 1.5V 'AAA' batteries located in the meter handle
Battery life	> 8 hours; typical
Automatic Power OFF	User-adjustable (5, 10, and 20 seconds)
Alarms	Color-coded High, Low, and High/Low combination alarms
Certifications	CE/FDA Laser
Warranty	5 years
Accessories	Includes Lanyard, Type K thermocouple (TG56), User Guide
Dimensions (H x W x D)/Weight	6.2 x 1.7 x 2.9 in. (158 x 44 x 73mm) / 11 oz. (312g)

### 8.2 Environmental Specifications

Operating Temperature	14 ~ 113°F (-10 ~ 45°C)
Storage Temperature	-22 ~ 131°F (-30 ~ 55°C)
Relative Humidity	0% ~ 90% [32°F ~ 98.6°F (0°C ~ 37°C)]
	0% ~ 65% [98.6°F ~ 113°F (37°C ~ 45°C)]
	0% ~ 45% [113°F ~ 131°F (45°C ~ 55°C)]
	Non-condensing (for all ranges above)

## 8.3 IR Thermometer Specifications

IR Temp. Measurement range	-22°F ~ +1202°F (-30°C ~ +650°C)
Over- and under- range indication	OL
IR Temperature Resolution	0.1°C (0.1°F up to 999°F and 1°F when ≥ 1000°F)
IR Temperature Accuracy	-22° ~ +14°F (-30° ~ -10°C): ±5.4°F (3.0°C) +14° ~ +32°F (-10° ~ < 0°C): ±3.6°F (2.0°C) +32° ~ +1202°F (0° ~ +650°C): ±1.8°F (±1.0°C) or ±1.0% (whichever is greater)
Distance to Spot (D:S) ratio	24:1 for TG54 30:1 for TG56
Field of view angle	0.04°
IR Temperature Response Time	150ms
Temperature Scanning	Continuous
Emissivity	4 presets plus a custom setting (0.10 ~ 0.99)

## 8.4 Laser Specifications

Laser type	Single Class 1 Laser (red; visible light)
Laser wavelength	650nm ±20nm
Laser power	≤0.39 mW
Laser alignment	Parallel to measurement 'cone'; see Section 5.3, <i>Distance to Spot Ratio</i>

## 8.5 Thermocouple Specifications

Thermocouple type	Type K
Meter input range*	-22° to 1202°F (-30° to 650°C)
Meter input accuracy	±3.6°F (2°C) or ±1% whichever is greater Not including additional probe error: ±4.5°F (2.5°C)
Measurement resolution	0.1°C (0.1°F up to 999°F and 1°F when ≥ 1000°F)
*Included Type K probe range	-22° to 572°F (-30° to 300°C)

## 9 Appendices

---

### 9.1 Emissivity Factors for Common Materials

Material	Emissivity	Material	Emissivity
Asphalt	0.90 to 0.98	Cloth (black)	0.98
Concrete	0.94	Skin (human)	0.98
Cement	0.96	Leather	0.75 to 0.80
Sand	0.90	Charcoal (powder)	0.96
Soil	0.92 to 0.96	Lacquer	0.80 to 0.95
Water	0.92 to 0.96	Lacquer (matt)	0.97
Ice	0.96 to 0.98	Rubber (black)	0.94
Snow	0.83	Plastic	0.85 to 0.95
Glass	0.90 to 0.95	Timber	0.90
Ceramic	0.90 to 0.94	Paper	0.70 to 0.94
Marble	0.94	Chromium Oxides	0.81
Plaster	0.80 to 0.90	Copper Oxides	0.78
Mortar	0.89 to 0.91	Iron Oxides	0.78 to 0.82
Brick	0.93 to 0.96	Textiles	0.90



## 9.2 Infrared Energy and IR Thermometer Theory

Infrared energy is part of a complete range of radiation called the electromagnetic spectrum. The electromagnetic spectrum includes gamma rays, X-rays, ultraviolet, visible, infrared, microwaves (RADAR), and radio waves. The only difference is their wavelength or frequency. All of these forms of radiation travel at the speed of light. Infrared radiation lies between the visible and RADAR portions of the electromagnetic spectrum.

The primary source of infrared radiation is heat or thermal radiation. Any object which has a temperature radiates in the infrared portion of the electromagnetic spectrum. Even objects that are very cold, such as an ice cube, emit infrared. When an object is not quite hot enough to radiate visible light, it will emit most of its energy in the infrared. For example, hot charcoal may not give off light, but it does emit infrared radiation, which we feel as heat. The warmer the object, the more infrared radiation it emits.

IR Thermometers measure an object's surface temperature. The thermometer's optics sense an object's emitted, reflected, and transmitted energy.

The TG Series translates the sensed information (targeted by the Laser) into a temperature reading that is displayed in text on the center of the display. If the thermometer measurement exceeds the published temperature range, the display will indicate OL.

The amount of IR energy emitted by an object is proportional to an object's temperature and its ability to emit energy. This ability is known as emissivity and is based on the material of the object and its surface finish. Emissivity values range from 0.1 for a very reflective object to 1.00 for a flat black finish.

The TG Series has both adjustable and preset emissivity settings. There are four (4) presets and an adjustable emissivity span from 0.10 to 0.99. See the Appendix for a list of common materials and their respective Emissivity factors. Access the Programming menu (covered in Section 6) to set the desired emissivity factor.

## 10 Customer Support

---

<b>Main Website</b>	<a href="http://www.flir.com/test">http://www.flir.com/test</a>
<b>Technical Support Website</b>	<a href="http://support.flir.com">http://support.flir.com</a>
<b>Technical support Email</b>	TMSupport@flir.com
<b>Service/Repair Support Email</b>	Repair@flir.com
<b>Support Telephone number</b>	+1 855-499-3662 option 3 (toll-free)

# 11 Warranty Information

## 11.1 FLIR Test & Measurement 5 year Limited Warranty

A qualifying FLIR Test and Measurement product (the “Product”) purchased either directly from FLIR Commercial Systems Inc. and affiliates (FLIR) or from an authorized FLIR distributor or reseller that Purchaser registers on-line with FLIR is eligible for coverage under FLIR’s Limited Warranty, subject to the terms and conditions in this document. This warranty only applies to purchases of Qualifying Products (see below) purchased and manufactured after April 1, 2015.

PLEASE READ THIS DOCUMENT CAREFULLY; IT CONTAINS IMPORTANT INFORMATION ABOUT THE PRODUCTS THAT QUALIFY FOR COVERAGE UNDER THE LIMITED WARRANTY, PURCHASER’S OBLIGATIONS, HOW TO ACTIVATE THE WARRANTY, WARRANTY COVERAGE, AND OTHER IMPORTANT TERMS, CONDITIONS, EXCLUSIONS AND DISCLAIMERS.

1. **PRODUCT REGISTRATION.** To qualify for FLIR’s Limited Warranty, Purchaser must fully register the Product directly with FLIR on-line at <http://www.flir.com/testwarranty> within Sixty (60) DAYS of the date the Product was purchased by the first retail customer (the “Purchase Date”). Qualifying PRODUCTS THAT ARE NOT REGISTERED ON-LINE WITHIN SIXTY (60) DAYS OF THE PURCHASE DATE WILL HAVE A LIMITED ONE YEAR WARRANTY FROM DATE OF PURCHASE.
2. **QUALIFYING PRODUCTS.** Upon registration, Test and Measurement products that qualify for coverage under FLIR’s Limited Warranty are: TG5x not including accessories which may have their own warranty.
3. **WARRANTY PERIODS.** The applicable Limited Warranty Period measured from the Purchase data are:

Products	Limited Warranty Period
TG5x	FIVE (5) Years

Any Product that is repaired or replaced under warranty is covered under this Limited Warranty for one hundred eighty days (180) days from the date of return shipment by FLIR or for the remaining duration of the applicable Warranty Period, whichever is longer.

4. **LIMITED WARRANTY.** In accordance with the terms and conditions of this Limited Warranty, and except as excluded or disclaimed in this document, FLIR warrants, from the Purchase Date, that all fully registered Products will conform to FLIR’s published product specifications and be free from defects in materials and workmanship during the applicable Warranty Period. PURCHASER’S SOLE AND EXCLUSIVE REMEDY UNDER THIS WARRANTY, AT FLIR’S SOLE DISCRETION, IS THE REPAIR OR REPLACEMENT OF DEFECTIVE PRODUCTS IN A MANNER, AND BY A SERVICE CENTER, AUTHORIZED BY FLIR. IF THIS REMEDY IS ADJUDICATED TO BE INSUFFICIENT, FLIR SHALL REFUND PURCHASER’S PAID PURCHASE PRICE AND HAVE NO OTHER OBLIGATION OR LIABILITY TO BUYER WHATSOEVER.

5. **WARRANTY EXCLUSIONS AND DISCLAIMERS.** FLIR MAKES NO OTHER WARRANTY OF ANY KIND WITH RESPECT TO THE PRODUCTS. ALL OTHER WARRANTIES, EXPRESS OR IMPLIED, INCLUDING BUT NOT LIMITED TO IMPLIED WARRANTIES OF MERCHANTABILITY, FITNESS FOR A PARTICULAR PURPOSE (EVEN IF PURCHASER HAS NOTIFIED FLIR OF ITS INTENDED USE FOR THE PRODUCTS), AND NON-INFRINGEMENT ARE EXPRESSLY EXCLUDED FROM THIS AGREEMENT.

THIS WARRANTY EXPRESSLY EXCLUDES ROUTINE PRODUCT MAINTENANCE, SOFTWARE UPDATES, AND REPLACEMENT OF FUSES, OR DISPOSABLE BATTERIES. FLIR FURTHER EXPRESSLY DISCLAIMS ANY WARRANTY COVERAGE WHERE THE ALLEGED NONCONFORMITY IS DUE TO NORMAL WEAR AND TEAR, OTHER ALTERATION, MODIFICATION, REPAIR, ATTEMPTED REPAIR, IMPROPER USE, IMPROPER MAINTENANCE, NEGLIGENCE, ABUSE, IMPROPER STORAGE, FAILURE TO FOLLOW ANY PRODUCT INSTRUCTIONS, DAMAGE (WHETHER CAUSED BY ACCIDENT OR OTHERWISE), OR ANY OTHER IMPROPER CARE OR HANDLING OF THE PRODUCTS CAUSED BY ANYONE OTHER THAN FLIR OR FLIR’S EXPRESSLY AUTHORIZED DESIGNEE.

THIS DOCUMENT CONTAINS THE ENTIRE WARRANTY AGREEMENT BETWEEN PURCHASER AND FLIR AND SUPERSEDES ALL PRIOR WARRANTY NEGOTIATIONS, AGREEMENTS, PROMISES AND UNDERSTANDINGS BETWEEN PURCHASER AND FLIR. THIS WARRANTY MAY NOT BE ALTERED WITHOUT THE EXPRESS WRITTEN CONSENT OF FLIR.

6. **WARRANTY RETURN, REPAIR AND REPLACEMENT.** To be eligible for warranty repair or replacement, Purchaser must notify FLIR within thirty (30) days of discovering of any apparent defect in materials or workmanship. Before Purchaser may return a Product for warranty service or repair, Purchaser must first obtain a returned material authorization (RMA) number from FLIR. To obtain the RMA number Owner must provide an original proof of purchase. For additional information, to notify FLIR of an apparent defect in materials or workmanship, or to request an RMA number, visit <http://www.flir.com>. Purchaser is solely

responsible for complying with all RMA instructions provided by FLIR including but not limited to adequately packaging the Product for shipment to FLIR and for all packaging and shipping costs. FLIR will pay for returning to Purchaser any Product that FLIR repairs or replaces under warranty.

FLIR reserves the right to determine, in its sole discretion, whether a returned Product is covered under Warranty. If FLIR determines that any returned Product is not covered under Warranty or is otherwise excluded from Warranty coverage, FLIR may charge Purchaser a reasonable handling fee and return the Product to Purchaser, at Purchaser's expense, or offer Purchaser the option of handling the Product as a non-warranty return.

**7. NON-WARRANTY RETURN.** Purchaser may request that FLIR evaluate and service or repair a Product not covered under warranty, which FLIR may agree to do in its sole discretion. Before Purchaser returns a Product for non-warranty evaluation and repair, Purchaser must contact FLIR by visiting <http://www.flir.com> to request an evaluation and obtain an RMA. Purchaser is solely responsible for complying with all RMA instructions provided by FLIR including but not limited to adequately packaging the Product for shipment to FLIR and for all packaging and shipping costs. Upon receipt of an authorized non-warranty return, FLIR will evaluate the Product and contact Purchaser regarding the feasibility of and the costs and fees associated with Purchaser's request. Purchaser shall be responsible for the reasonable cost of FLIR's evaluation, for the cost of any repairs or services authorized by Purchaser, and for the cost of repackaging and returning the Product to Purchaser.

Any non-warranty repair of a Product is warranted for one hundred eighty days (180) days from the date of return shipment by FLIR to be free from defects in materials and workmanship only, subject to all of the limitations, exclusions and disclaimers in this document.



---

## Corporate Headquarters

FLIR Systems, Inc.

2770 SW Parkway Avenue

Wilsonville, OR 97070

USA

Telephone: +1 503-498-3547

## Customer Support

Technical Support Website <http://support.flir.com>

Technical Support Email [TMSupport@flir.com](mailto:TMSupport@flir.com)

Service and Repair Email [Repair@flir.com](mailto:Repair@flir.com)

Customer Support Telephone +1 855-499-3662 option 3 (toll free)

Publication Identification No.: TG54\_TG56-en-US

Release version: AA

Release Date: 2015 September

Language: en-US

## X-ON Electronics

Largest Supplier of Electrical and Electronic Components

*Click to view similar products for [Environmental Test Equipment](#) category:*

*Click to view products by [Teledyne FLIR / Extech](#) manufacturer:*

Other Similar products are found below :

[CW40](#) [F150C10E3DRT](#) [F150LTC20](#) [F150CD10E2](#) [F150L75](#) [F150LRS](#) [2837806](#) [4328074](#) [4366444](#) [S-11](#) [382153](#) [700PTP-1](#) [GEO-](#)  
[CABLE-REEL-50M](#) [H115](#) [H300](#) [F150-SLC50](#) [AW-CO-1000](#) [AW-H2S-100](#) [AW-NmHc-100](#) [ES1-CO-1000-01](#) [P 2801](#) [P 2802](#) [TM-197](#)  
[ULD-420-EUR](#) [TM-192](#) [TM-192D](#) [TM-305U](#) [UT309C](#) [EL-P-TC-T-SURFACE](#) [1500000059](#) [HS115](#) [MR59](#) [12227021](#) [13123602](#) [13123661](#)  
[12255930](#) [12983030](#) [30171091](#) [30198712](#) [30198755](#) [30209323](#) [12228657](#) [12229067](#) [12230090](#) [7358958](#) [12231398](#) [12231487](#) [7390674](#)  
[7390682](#) [12231550](#)