

Telit EVK2 User Guide

1wv0300704 Rev.18 – 2014/06/30



APPLICABILITY LIST:



Model	Part Number	Engine
EVK2	3990150474	Mother Board
EVK2-M2MAIR	3990150502	Mother Board + m2mAIR SIM
GM862 INTERFACE	3990250670	GM862
GE863-PY INTERFACE	3990250684	GE863-PY
GE863-GPS INTERFACE	3990250696	GE863-GPS
GE863-SIM INTERFACE	3990250703	GE863-SIM
GE864-PY INTERFACE	3990250672	GE864-PY
GE864-QUAD V2 INTERFACE	3990250777	GE864-QUAD V2
GE864-DUAL V2 INTERFACE	3990250778	GE864-DUAL V2
GE864-QUAD AUTOMOTIVE V2 INTERFACE	3990250773	GE864-QUAD AUTOMOTIVE V2
GE864-QUAD ATEX V2 INTERFACE	3990250772	GE864-QUAD ATEX V2
GE864-QUAD SIM V2 INTERFACE	3990250771	GE864-QUAD SIM V2
	3990250820	
GE864-GPS INTERFACE	3990250821	GE864-GPS
	3990250822	
GC864 INTERFACE	3990250680	GC864
GC864-QUAD-C2 INTERFACE	3990250683	GC864-QUAD-C2
GE865-QUAD INTERFACE	3990250766	GE865-QUAD
GE865/SE867-AGPS INTERFACE	3990250814	GE865-QUAD
GE865/JF2 INTERFACE	3990250868	GE865-QUAD
GL865/JN3 INTERFACE	3990250954	GL865-QUAD
GL865-QUAD INTERFACE	3990250812	GL865-QUAD
GL865-DUAL INTERFACE	3990250783	GL865-DUAL
GL868-DUAL INTERFACE	3990250790	GL868-DUAL
UC864 INTERFACE	4990150470	UC864
HE863-EUR INTERFACE	3990250797	HE863
HE863-EUG INTERFACE	3990250798	HE863



HE863-NAD INTERFACE	3990250799	HE863
HE863-NAR INTERFACE	3990250800	HE863
HE863-NAG INTERFACE	3990250801	HE863
HE863-AUR INTERFACE	3990250803	HE863
HE863-AUG INTERFACE	3990250804	HE863
HE910 INTERFACE	3990250845	HE910
UE910-EUR INTERFACE	3990250918	UE910-EUR
UE910-NAR INTERFACE	3990250919	UE910-NAR
GE910 INTERFACE	3990250882	GE910
GE910-GNSS INTERFACE	3990250941	GE910-GNSS
GE910-QUAD V3 INTERFACE	3990251006	GE910-QUAD V3
DE910 INTERFACE	3990250886	DE910
CE910 INTERFACE	3990250887	CE910
GL865-DUAL V3 1.8V INTERFACE	3990250948	GL865-DUAL V3
LE920-EU INTERFACE	3990251000	LE920-EU
LE920-NA INTERFACE	3990250999	LE920-NA
HE920-EU INTERFACE	3990250966	HE920-EU
HE920-NA INTERFACE	3990250967	HE920-NA
HE910 V2-EUG INTERFACE	3990250977	HE910 V2-EUG
HE910 V2-NAG INTERFACE	3990250978	HE910 V2-NAG
UE910-EU V2 INTERFACE	3990250989	UE910-EU V2
UE910-NA V2 INTERFACE	3990250988	UE910_NA V2
CL865-DUAL INTERFACE	3990251051	CL865-DUAL
GE866-QUAD INTERFACE	3990251048	GE866-QUAD
UL865-EUR INTERFACE	3990250961	UL865-EUR
UL865-NAR INTERFACE	3990250962	UL865-NAR
LE910-NAG INTERFACE	3990251036	LE910-NAG
LE910-NVG INTERFACE	3990251037	LE910-NVG
LE910-SVG INTERFACE	3990251087	LE910-SVG
LE910-EUG INTERFACE	3990251061	LE910-EUG



SPECIFICATIONS SUBJECT TO CHANGE WITHOUT NOTICE

Notice

While reasonable efforts have been made to assure the accuracy of this document, Telit assumes no liability resulting from any inaccuracies or omissions in this document, or from use of the information obtained herein. The information in this document has been carefully checked and is believed to be entirely reliable. However, no responsibility is assumed for inaccuracies or omissions. Telit reserves the right to make changes to any products described herein and reserves the right to revise this document and to make changes from time to time in content hereof with no obligation to notify any person of revisions or changes. Telit does not assume any liability arising out of the application or use of any product, software, or circuit described herein; neither does it convey license under its patent rights or the rights of others.

It is possible that this publication may contain references to, or information about Telit products (machines and programs), programming, or services that are not announced in your country. Such references or information must not be construed to mean that Telit intends to announce such Telit products, programming, or services in your country.

Copyrights

This instruction manual and the Telit products described in this instruction manual may be, include or describe copyrighted Telit material, such as computer programs stored in semiconductor memories or other media. Laws in the Italy and other countries preserve for Telit and its licensors certain exclusive rights for copyrighted material, including the exclusive right to copy, reproduce in any form, distribute and make derivative works of the copyrighted material. Accordingly, any copyrighted material of Telit and its licensors contained herein or in the Telit products described in this instruction manual may not be copied, reproduced, distributed, merged or modified in any manner without the express written permission of Telit. Furthermore, the purchase of Telit products shall not be deemed to grant either directly or by implication, estoppel, or otherwise, any license under the copyrights, patents or patent applications of Telit, as arises by operation of law in the sale of a product.

Computer Software Copyrights

The Telit and 3rd Party supplied Software (SW) products described in this instruction manual may include copyrighted Telit and other 3rd Party supplied computer programs stored in semiconductor memories or other media. Laws in the Italy and other countries preserve for Telit and other 3rd Party supplied SW certain exclusive rights for copyrighted computer programs, including the exclusive right to copy or reproduce in any form the copyrighted computer program. Accordingly, any copyrighted Telit or other 3rd Party supplied SW computer programs contained in the Telit products described in this instruction manual may not be copied (reverse engineered) or reproduced in any manner without the express written permission of Telit or the 3rd Party SW supplier. Furthermore, the purchase of Telit products shall not be deemed to grant either directly or by implication, estoppel, or otherwise, any license under the copyrights, patents or patent applications of Telit or other 3rd Party



supplied SW, except for the normal non-exclusive, royalty free license to use that arises by operation of law in the sale of a product.

Usage and Disclosure Restrictions

License Agreements

The software described in this document is the property of Telit and its licensors. It is furnished by express license agreement only and may be used only in accordance with the terms of such an agreement.

Copyrighted Materials

Software and documentation are copyrighted materials. Making unauthorized copies is prohibited by law. No part of the software or documentation may be reproduced, transmitted, transcribed, stored in a retrieval system, or translated into any language or computer language, in any form or by any means, without prior written permission of Telit

High Risk Materials

Components, units, or third-party products used in the product described herein are NOT fault-tolerant and are NOT designed, manufactured, or intended for use as on-line control equipment in the following hazardous environments requiring fail-safe controls: the operation of Nuclear Facilities, Aircraft Navigation or Aircraft Communication Systems, Air Traffic Control, Life Support, or Weapons Systems (High Risk Activities”). Telit and its supplier(s) specifically disclaim any expressed or implied warranty of fitness for such High Risk Activities.

Trademarks

TELIT and the Stylized T Logo are registered in Trademark Office. All other product or service names are the property of their respective owners.

Copyright © Telit Communications S.p.A.



Contents

1. Introduction.....	18
1.1. Scope.....	18
1.2. Audience.....	18
1.3. Contact Information, Support.....	18
1.4. Text Conventions.....	19
1.5. Related Documents.....	19
1.6. Content of the kit.....	20
2. Description.....	21
2.1. PCB characteristics	22
2.2. Mechanical characteristics of the assembled PCBs.....	23
2.2.1. Mother Board CS1139B	23
2.2.2. GM862 Interface CS1150B	23
2.2.3. GE863 Interface CS1151A	23
2.2.4. GE864 Interface CS1152B	23
2.2.5. GE864-GPS Interface CS1439B.....	23
2.2.6. GC864 Interface CS1203B	24
2.2.7. GC864-C2 Interface CS1231X.....	24
2.2.8. GE865 Interface CS1324A	24
2.2.9. GE865/SE867-AGPS Interface CS1433	24
2.2.10. GE865/JF2 Interface CS1521	24
2.2.11. GL865 Interface CS1431A	24
2.2.12. UC864-CC864 Interface KS0101C	25
2.2.13. HE910 Interface CS1467C	25
2.2.14. UE910 Interface CS1467D	25
2.2.15. GE910 Interface CS1467D	25
2.2.16. GE910-GNSS Interface CS1467F	25
2.2.17. GE910-QUAD V3 Interface CS1467F.....	25
2.2.18. DE910 Interface CS1467D	25
2.2.19. CE910 Interface CS1467D	25
2.2.20. GL865 V3 Interface CS1531B	26
2.2.21. LE920 Interface KS0145B	26
2.2.22. HE920 Interface KS0145B	26
2.2.23. HE910 V2 Interface CS1467D	26
2.2.24. UE910 V2 Interface CS1467D	26
2.2.25. CL865 Interface CS1531B	26
2.2.26. GE866-QUAD Interface CS1582	26
2.2.27. UL865 Interface CS1531B	27
2.2.28. LE910 Interface CS1467F	27
3. Startup procedure.....	28
4. Insertion of the Interface Boards.....	29
5. Power supply setting	30
5.1. Fixed DC source.....	30



5.2.	Variable DC source	31
5.2.1.	Coaxial Plug.....	32
5.3.	Li-Ion Battery pack and Charger	32
5.4.	Application Notes	33
5.4.1.	Li-Ion Battery Pack.....	33
5.4.2.	About Current Charger	33
6.	Serial interface	34
6.1.	Serial Port Setup.....	35
7.	Audio Section.....	36
7.1.	Overview	36
7.1.1.	History	36
7.2.	Actual.....	37
7.2.1.	The choice.....	37
7.3.	Differential and Single Ended	37
7.3.1.	Concepts.....	37
7.3.2.	Benefits and disadvantages.....	38
7.3.3.	Settings.....	39
8.	AF Amplifiers Setting	40
9.	Audio outputs	41
9.1.	Low AF Power Mode	41
9.2.	High AF Power Mode.....	42
9.2.1.	Speaker and Stand-alone Microphone	43
9.2.2.	Speaker plus Headset	44
10.	Audio Accessories	45
10.1.	Headset	45
10.2.	Stand-alone microphone	46
10.3.	Speaker	46
11.	Indication and services.....	47
11.1.	Optical Indicators.....	47
11.1.1.	Status Led	47
11.1.2.	CHARGE Led.....	48
11.2.	Switches	49
11.2.1.	POWER ON Switch.....	49
11.2.2.	RESET Switch	49
12.	Connectors pinout	50
12.1.	Motherboard to Module	50
13.	Module Interface Boards	53



- 13.1. Generality.....53**
- 13.2. Short Description.....53**
- 13.3. Further Accessories for GPS version.....53**
- 14. GM862 Interface 54**
- 14.1. Stand-alone setup54**
- 14.2. Interface connectors55**
- 14.3. Content of the kit.....55**
- 15. GE863 Interface..... 56**
- 15.1. Stand-alone setup56**
- 15.2. Content of the kits57**
 - 15.2.1. GE863-PY/QUAD version 57
 - 15.2.2. GE863-GPS version..... 57
 - 15.2.3. GE863-SIM version..... 57
- 15.3. Interface connectors57**
- 15.4. Additional components for GPS version57**
- 15.5. USB connector58**
- 15.6. Serial port configuration.....59**
 - 15.6.1. GE863-PY/QUAD 60
 - 15.6.2. GE863 – GPS..... 60
- 15.7. ANTENNA connectors.....62**
 - 15.7.1. GPS ANTENNA connector 62
 - 15.7.2. GSM ANTENNA connector..... 62
 - 15.7.3. RFU ANTENNA connector 62
- 16. GE864 Interface..... 63**
- 16.1. Stand-alone setup63**
- 16.2. Interface connectors64**
- 16.3. Content of the kit.....64**
- 17. GE864-GPS Interface 65**
- 17.1. Part numbering.....65**
- 17.2. Stand-alone setup66**
- 17.3. Interface connectors66**
- 17.4. Contents of the kit66**
- 17.5. Power supply.....67**
- 17.6. GPS external LNA enable signal.....67**
- 17.7. Serial port configuration.....68**



17.7.1.	ASC1 to RS-232	69
17.7.2.	GPS to ASC1 (internal host controlling configuration)	69
17.7.3.	GPS to RS-232 (external host controlling configuration)	70
17.7.4.	GPS to USB	70
17.8.	GPIO settings.....	71
17.8.1.	Internal host controlling configuration	71
17.8.2.	External host controlling configuration	72
17.9.	Antenna connectors.....	74
17.9.1.	GSM antenna connector	74
17.9.2.	GPS antenna connector.....	74
18.	GE865 – SE867 AGPS Interface	75
18.1.	Stand-alone setup	75
18.2.	Interface connectors	76
18.3.	Contents of the kit	76
18.4.	Serial connections.....	77
18.4.1.	GSM to GPS (GSM controlling configuration).....	77
18.4.2.	GSM to Trace.....	78
18.4.3.	GPS to Trace(external host controlling configuration)	79
18.5.	Antenna connectors.....	79
18.5.1.	GSM antenna connector	79
18.5.2.	GPS antenna connector.....	79
19.	GE865 – JF2 Interface	80
19.1.	Stand-alone setup	80
19.2.	Interface connectors	81
19.3.	Contents of the kit	81
19.4.	Power supply.....	81
19.5.	GPS external LNA enable signal.....	82
19.6.	Serial port configuration.....	84
19.7.	GSM to Trace.....	85
19.8.	GPS to Trace.....	85
19.9.	GSM to USB.....	86
19.10.	GPS to USB	86
19.11.	GPS to GSM (internal host controlling configuration).....	87
19.12.	GPIO settings.....	87
19.12.1.	Internal host controlling configuration	88
19.12.2.	External host controlling configuration	89
19.13.	GPS serial interface setting	90
19.14.	MEMS Sensor/EEPROM Interface.....	90



19.15. GPS power-on management	90
19.16. Antenna connectors	91
19.16.1. GSM antenna connector	91
19.16.2. GPS antenna connector	91
20. GL865 – SL869/JN3 Interface	92
20.1. Stand-alone setup	93
20.2. Interface connectors	93
20.3. Contents of the kit	93
20.1. Power supply	94
20.2. GPS external LNA enable signal	95
20.3. Serial port configuration	96
20.4. GSM to Trace	97
20.5. GPS to Trace	97
20.6. GSM to USB	98
20.7. GPS to USB	98
20.8. GPS to GSM (internal host controlling configuration)	99
20.9. GPIO settings	100
20.9.1. Internal host controlling configuration	100
20.9.2. External host controlling configuration	101
20.10. Antenna connectors	102
20.10.1. GSM antenna connector	102
20.10.2. GPS antenna connector	102
21. GC864 Interface	103
21.1. Stand-alone setup	103
21.2. Interface connectors	104
21.3. Content of the kit	104
22. GC864-C2 family Interface	105
22.1. Stand-alone setup	105
22.2. Interface connectors	106
22.3. Content of the kit	106
23. GE865 Interface	107
23.1. Stand-alone setup	107
23.2. Interface connectors	108
23.3. Content of the kit	108



- 24. GL865 Interface..... 109**
- 24.1. Stand-alone setup109
- 24.2. Interface connectors110
- 24.3. Content of the kit.....110
- 25. UC864 family Interface..... 111**
- 25.1. Stand-alone setup111
- 25.2. Interface connectors112
- 25.3. Content of the kit.....112
- 26. HE910 family Interface..... 113**
- 26.1. Stand-alone setup114
- 26.2. Interface connectors114
- 26.3. Antenna connectors.....115**
 - 26.3.1. GSM/UMTS Antenna connector 115
 - 26.3.2. Receiver Diversity Antenna connector 115
 - 26.3.3. GPS antenna connector 115
- 26.4. Expansion Connectors116**
 - 26.4.1. PL301/PL302 116
 - 26.4.2. PL303/PL304/PL305 117
 - 26.4.3. PL102 118
 - 26.4.4. ON_OFF & UNCONDITIONAL SHUTDOWN BUTTONS 118
- 26.5. Content of the kit.....118
- 27. UE910 family Interface 119**
- 27.1. Stand-alone setup120
- 27.2. Interface connectors120
 - 27.2.1. GSM/UMTS Antenna connector 121
- 27.3. Expansion Connectors121**
 - 27.3.1. PL301/PL302 121
 - 27.3.2. PL303/PL304/PL305 122
 - 27.3.3. PL102 123
 - 27.3.4. ON_OFF & UNCONDITIONAL SHUTDOWN BUTTONS 123
- 27.4. Content of the kit.....123
- 28. GE910 Interface..... 124**
- 28.1. Stand-alone setup125
- 28.2. Interface connectors125
- 28.3. Antenna connectors126
 - 28.3.1. GSM/GPRS Antenna connector 126
- 28.4. Expansion Connectors126



28.4.1.	PL301/PL302	126
28.4.2.	PL303/PL304	127
28.4.3.	PL102	127
28.4.4.	ON_OFF & UNCONDITIONAL SHUTDOWN BUTTONS	128
28.5.	Content of the kit.....	128
29.	GE910-GNSS Interface.....	129
29.1.	Stand-alone setup	130
29.2.	Interface connectors	130
29.3.	Antenna connectors	131
29.3.1.	GSM/GPRS Antenna connector	131
29.3.2.	GNSS antenna connector	131
29.4.	Expansion Connectors	132
29.4.1.	PL301/PL302	132
29.4.2.	PL303/PL304	133
29.4.3.	PL102	133
29.4.4.	ON_OFF & UNCONDITIONAL SHUTDOWN BUTTONS	134
29.5.	Content of the kit.....	134
30.	GE910-QUAD V3 Interface.....	135
30.1.	Stand-alone setup	136
30.2.	Interface connectors	136
30.3.	Antenna connectors	137
30.3.1.	GSM/GPRS Antenna connector	137
30.4.	Expansion Connectors	137
30.4.1.	PL301/PL302	137
30.4.2.	PL303/PL304	138
30.4.3.	PL102	138
30.4.4.	ON_OFF & UNCONDITIONAL SHUTDOWN BUTTONS	139
30.5.	Content of the kit.....	139
31.	DE910 family Interface	140
31.1.	Stand-alone setup	141
31.2.	Interface connectors	141
31.3.	Antenna connectors	142
31.3.1.	CDMA Antenna connector	142
31.3.2.	Receiver Diversity Antenna connector	142
31.3.3.	GPS antenna connector	142
31.4.	Expansion Connectors	143
31.4.1.	PL301/PL302	143
31.4.2.	PL303/PL304/PL305	144
31.4.3.	PL102	145
31.4.4.	ON_OFF & UNCONDITIONAL SHUTDOWN BUTTONS	145



31.5.	Content of the kit.....	145
32.	CE910 family Interface.....	146
32.1.	Stand-alone setup.....	147
32.2.	Interface connectors.....	147
32.3.	Antenna connectors.....	148
32.3.1.	CDMA Antenna connector.....	148
32.4.	Expansion Connectors.....	148
32.4.1.	PL301/PL302.....	148
32.4.2.	PL303/PL304.....	149
32.4.3.	PL102.....	149
32.4.4.	ON_OFF & UNCONDITIONAL SHUTDOWN BUTTONS.....	150
32.5.	Content of the kit.....	150
33.	GL865 V3 Interface.....	151
33.1.	Stand-alone setup.....	151
33.2.	Interface connectors.....	152
34.	LE920 Interface.....	153
34.1.	Stand-alone setup.....	154
34.2.	Interface connectors.....	154
34.3.	Antenna connectors.....	155
34.3.1.	Main Antenna connector.....	155
34.3.2.	Diversity Antenna connector.....	155
34.3.3.	GPS Antenna connector.....	155
34.4.	Expansion Connectors.....	155
34.4.1.	PL102/PL104.....	155
34.4.2.	ON_OFF & UNCONDITIONAL SHUTDOWN, RESET BUTTONS.....	157
34.5.	Content of the kit.....	157
35.	HE920 Family Interface.....	158
35.1.	Stand-alone setup.....	159
35.2.	Interface connectors.....	159
35.3.	Antenna connectors.....	160
35.3.1.	Main Antenna connector.....	160
35.3.2.	Diversity Antenna connector.....	160
35.3.3.	GPS Antenna connector.....	160
35.4.	Expansion Connectors.....	160
35.4.1.	PL102/PL104.....	160
35.4.2.	ON_OFF & UNCONDITIONAL SHUTDOWN, RESET BUTTONS.....	162
35.5.	Content of the kit.....	162
36.	HE910 V2 family Interface.....	163



36.1. Stand-alone setup	164
36.2. Interface connectors	164
36.3. Antenna connectors	165
36.3.1. GSM/UMTS Antenna connector	165
36.3.2. GPS antenna connector	165
36.4. Expansion Connectors	166
36.4.1. PL301/PL302	166
36.4.2. PL303/PL304/PL305	167
36.4.3. PL102	168
36.4.4. ON_OFF & UNCONDITIONAL SHUTDOWN BUTTONS	168
36.5. Content of the kit	168
37. UE910 V2 family Interface	169
37.1. Stand-alone setup	170
37.2. Interface connectors	170
37.3. Antenna connectors	171
37.3.1. GSM/UMTS Antenna connector	171
37.4. Expansion Connectors	171
37.4.1. PL301/PL302	171
37.4.2. PL303/PL304/PL305	172
37.4.3. PL102	173
37.4.4. ON_OFF & UNCONDITIONAL SHUTDOWN BUTTONS	173
37.5. Content of the kit	173
38. CL865 Interface	174
38.1. Stand-alone setup	174
38.2. Interface connectors	175
38.3. Antenna connectors	176
38.3.1. CDMA Antenna connector	176
38.4. Expansion Connectors	176
38.4.1. PL101	176
38.4.2. PL106	176
38.4.3. PL107	177
38.5. Content of the kit	177
39. GE866-QUAD Interface	178
39.1. Stand-alone setup	178
39.2. Interface connectors	179
39.3. Antenna connectors	180
39.3.1. GSM Antenna connector	180
39.4. Expansion Connectors	180
39.4.1. PL102	180



39.4.2.	PL101	181
39.4.3.	PL103	181
39.4.4.	PL104	182
39.4.5.	PL108	182
39.4.6.	PL403	182
39.4.7.	PL401 and 402	183
39.5.	Audio selection	183
39.6.	Content of the kit	183
40.	UL865 Interface	184
40.1.	Stand-alone setup	184
40.2.	Interface connectors	185
40.3.	Antenna connectors	186
40.3.1.	GSM Antenna connector	186
40.4.	Expansion Connectors	186
40.4.1.	PL101	186
40.4.2.	PL106	186
40.5.	Content of the kit	187
41.	LE910 Interface	188
41.1.	Stand-alone setup	189
41.2.	Interface connectors	189
41.3.	Antenna connectors	190
41.3.1.	GSM/GPRS Antenna connector	190
41.3.2.	GNSS antenna connector	190
41.4.	Expansion Connectors	191
41.4.1.	PL301/PL302	191
41.4.2.	PL303/PL304	192
41.4.3.	PL102	192
41.4.4.	ON_OFF & UNCONDITIONAL SHUTDOWN BUTTONS	193
41.5.	Content of the kit	193
42.	GPIO ports	194
42.1.	GPIO location	195
42.1.1.	GM862 Interface	195
42.1.2.	GE863-GPS Interface	197
42.1.3.	GE863 Interfaces (p/n 3990250684 -3990250685-3990250703)	199
42.1.4.	GE864 Interface (p/n 3990250672)	200
42.1.5.	GE864-GPS Interface (p/n 3990250822)	201
42.1.6.	GE865/SE867-AGPS Interface (p/n 3990250814)	202
42.1.7.	GC864 Interface	203
42.1.8.	GC864-C2 Interface (p/n 3990250683)	204
42.1.9.	UC864 Interface	205
42.1.10.	HE910 Interface	206
42.1.11.	GE910 Interface	208



42.1.12.	DE910 Interface	210
42.1.13.	CE910 Interface	212
42.1.14.	GL865 V3 Interface	214
42.1.15.	UL865 Interface	216
42.1.16.	HE920 Family Interface.....	218
42.1.17.	HE910 V2 Interface	220
42.1.18.	UE910 V2 Interface	222
42.1.19.	CL865 Interface	224
42.1.20.	GE866-QUAD Interface	225
42.1.21.	LE910 Interface	227
43.	SCHEMATICS	229
43.1.	EVK2 Mother Board.....	230
43.2.	GM862 Interface Board.....	235
43.3.	GE863 Interface Board	236
43.4.	GE864 Interface board	238
43.5.	GE864 Interface board – Automotive.....	239
43.6.	GE864 Interface board – V2.....	240
43.7.	GE864-GPS Interface board	241
43.8.	GE865/SE867-AGPS Interface board.....	243
43.9.	GE865 Interface board	245
43.10.	GL865 Interface board	246
43.11.	GC864 Interface board	247
43.12.	GC864-C2 Interface board	248
43.13.	UC864 Interface board	249
43.14.	HE910/UE910 Interface board.....	251
43.15.	GE910 Interface board	255
43.16.	GE910-GNSS Interface board.....	259
43.17.	GE910-QUAD V3 Interface board.....	263
43.18.	GE865 – JF2 Interface board	267
43.19.	GL865 – SL869/JN3 Interface board.....	270
43.20.	DE910 Interface board.....	273
43.21.	CE910 Interface board.....	277
43.22.	GL865 V3 Interface board.....	281
43.23.	LE920 Interface board.....	283
43.24.	HE920 family Interface board.....	286
43.25.	HE910 V2 Interface board.....	289



43.26. UE910 V2 Interface board.....	293
43.27. CL865 Interface board.....	297
43.28. GE866-QUAD Interface board	299
43.29. LE910 Interface board.....	303
43.30. UL865 Interface board.....	307
44. Service and firmware update	309
45. SAFETY RECOMMENDATIONS	310
45.1. Disposal of this product in the European Union.....	311
45.2. Disposal of this product in other countries outside the European Union.....	311
46. Document History	312



1. Introduction

1.1. Scope

The Aim of this document is the handling description of the *developer's Evaluation KIT* second edition, a laboratory tool named **EVK2**.

1.2. Audience

All given information shall be used as a guide and a starting point for properly developing of your product. Obviously this document cannot cover all the hardware solutions and products that may be designed.

1.3. Contact Information, Support

For general contact, technical support, to report documentation errors and to order manuals, contact Telit's Technical Support Center (TTSC) at:

TS-EMEA@telit.com
TS-NORTHAMERICA@telit.com
TS-LATINAMERICA@telit.com
TS-APAC@telit.com

Alternatively, use:

<http://www.telit.com/en/products/technical-support-center/contact.php>

For detailed information about where you can buy the Telit modules or for recommendations on accessories and components visit:

<http://www.telit.com>

To register for product news and announcements or for product questions contact Telit's Technical Support Center (TTSC).

Our aim is to make this guide as helpful as possible. Keep us informed of your comments and suggestions for improvements.

Telit appreciates feedback from the users of our information.



1.4. Text Conventions



Danger – This information MUST be followed or catastrophic equipment failure or bodily injury may occur.



Caution or Warning – Alerts the user to important points about integrating the module, if these points are not followed, the module and end user equipment may fail or malfunction.



Tip or Information – Provides advice and suggestions that may be useful when integrating the module.

All dates are in ISO 8601 format, i.e. YYYY-MM-DD.

1.5. Related Documents

- AT Commands Reference Guides of the relevant modules



1.6. Content of the kit

Please check out the content of your *EVK2* kit; if any of the items is missing, please contact your supplier.

Description	Quantity
EVK2 MOTHERBOARD	1
INFORMATION NOTE	1
2 PIN JUMPER FEMALE CONN	18
ASSEMBLED USB A-B CABLE	1
RED & BLACK CABLE WITH PLUGS	1
GSM-UMTS MAGNETIC ANTENNA CABLE RG174 WITH SMA/M	1

Table 1



GE863-PY Interface Board (upper) fitted on EVK2 Motherboard (lower).



2. Description

The motherboard *CS1139B* can be split into several functional blocks depending on the implemented function; the following drawings show a block diagram and the displacement of the main blocks on motherboard.

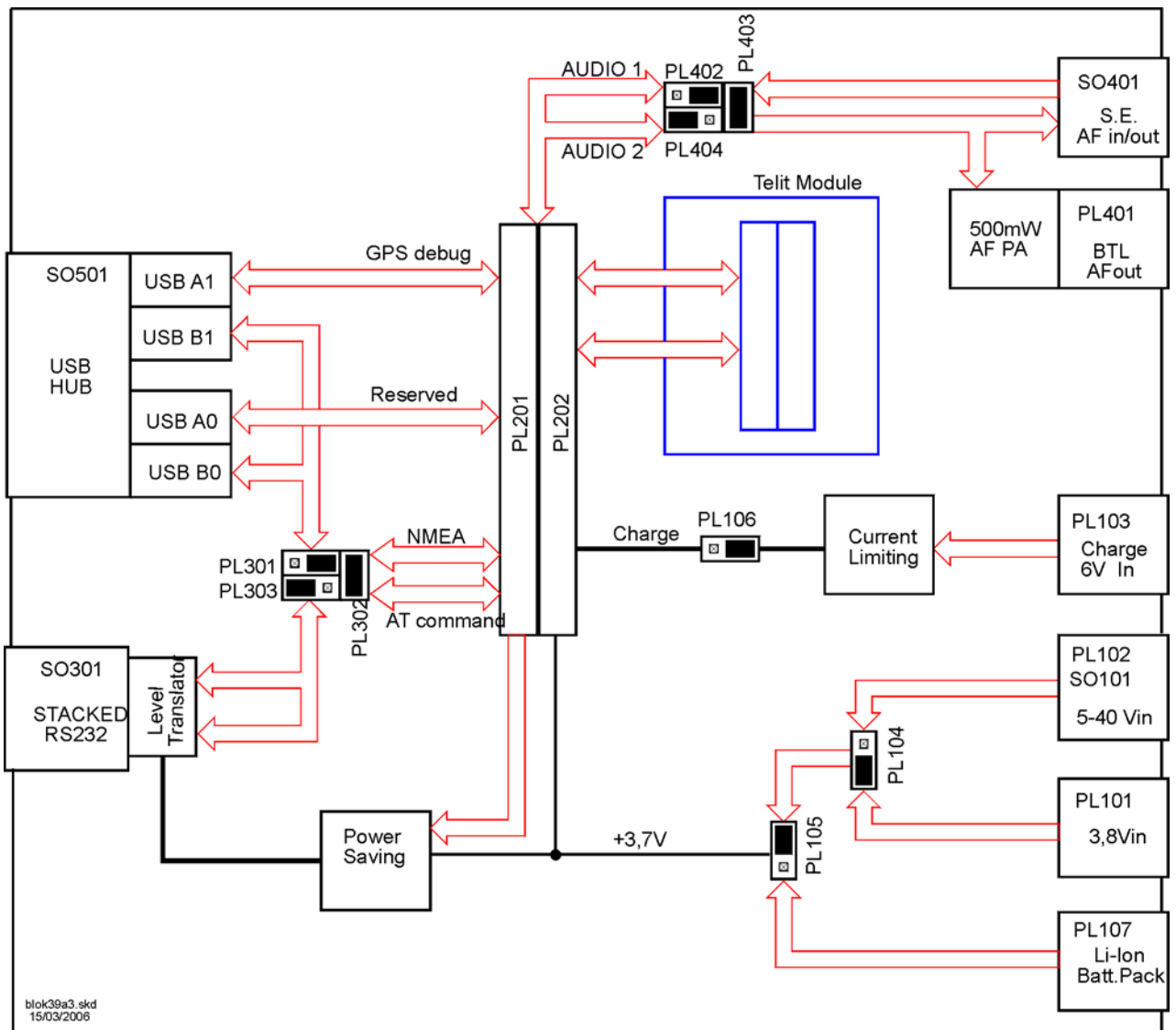

Miscellaneous signals, connections and routing on *CS1139B*.



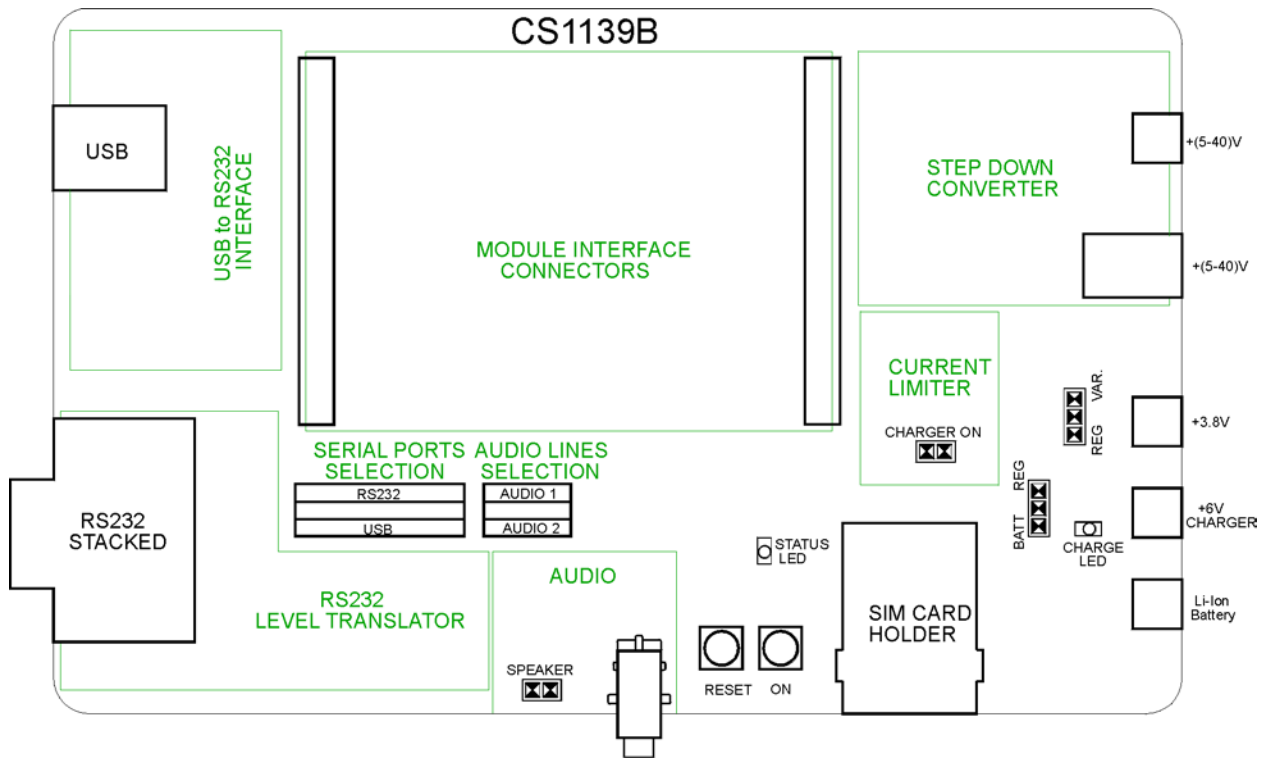

CS1139B circuitual displacement

2.1. PCB characteristics

Material: FR4
 Thickness: 0,95 mm
 Surface finishing: Chemical gold plate Ni 5um/ Au 0,1um



2.2. Mechanical characteristics of the assembled PCBs

2.2.1. Mother Board CS1139B

Length	100 mm (max 102,6 mm)
Width	160 mm (max 166,10mm)
Height	47,6 mm (included the support with columns)
Weight	200 gr (without any interface)

2.2.2. GM862 Interface CS1150B

Length	66,04 mm
Width	78,74 mm
Height	21,00 mm
Weight	27 gr (without the module)

2.2.3. GE863 Interface CS1151A

Length	75 mm (max 84,70mm)
Width	78,74 mm
Height	21,00 mm
Weight	40 gr (with module)
Weight	44,3 gr (with module for GPS version)

2.2.4. GE864 Interface CS1152B

Length	66,04 mm (max 75,20mm)
Width	78,74 mm
Height	21,00 mm
Weight	36 gr (with module)

2.2.5. GE864-GPS Interface CS1439B

Length	78.70 mm (max mm)
Width	83.70 mm
Height	21 mm



2.2.6. GC864 Interface CS1203B

Length	66,04 mm
Width	78,74 mm
Height	21,00 mm
Weight	27 gr (without the module)

2.2.7. GC864-C2 Interface CS1231X

Length	50,00 mm
Width	33,00 mm
Height	5,60 mm
Weight	13,8 gr (with module)

2.2.8. GE865 Interface CS1324A

Length	66,04 mm (max 75,20mm)
Width	78,74 mm
Height	21,00 mm
Weight	34 gr (with module)

2.2.9. GE865/SE867-AGPS Interface CS1433

Length	101,00 mm
Width	78,74 mm
Height	mm

2.2.10. GE865/JF2 Interface CS1521

Length	101,00 mm
Width	78,74 mm
Height	mm

2.2.11. GL865 Interface CS1431A

Length	66,04 mm (max 75,20mm)
Width	78,74 mm
Height	21,00 mm
Weight	34 gr (with module)



2.2.12. UC864-CC864 Interface KS0101C

Length	102,00 mm
Width	67,50 mm
Height	20,80 mm
Weight	55 gr (without module)

2.2.13. HE910 Interface CS1467C

Length	107,00 mm
Width	102,00 mm
Height	25,00 mm

2.2.14. UE910 Interface CS1467D

Length	107,00 mm
Width	102,00 mm
Height	25,00 mm

2.2.15. GE910 Interface CS1467D

Length	107,00 mm
Width	102,00 mm
Height	25,00 mm

2.2.16. GE910-GNSS Interface CS1467F

Length	107,00 mm
Width	102,00 mm
Height	25,00 mm

2.2.17. GE910-QUAD V3 Interface CS1467F

Length	107,00 mm
Width	102,00 mm
Height	25,00 mm

2.2.18. DE910 Interface CS1467D

Length	107,00 mm
Width	102,00 mm
Height	25,00 mm

2.2.19. CE910 Interface CS1467D

Length	107,00 mm
Width	102,00 mm
Height	25,00 mm



2.2.20. GL865 V3 Interface CS1531B

Length	92,00 mm
Width	89,00 mm
Height	25,00 mm

2.2.21. LE920 Interface KS0145B

Length	92,00 mm
Width	107,00 mm
Height	25,00 mm

2.2.22. HE920 Interface KS0145B

Length	92,00 mm
Width	107,00 mm
Height	25,00 mm

2.2.23. HE910 V2 Interface CS1467D

Length	107,00 mm
Width	102,00 mm
Height	25,00 mm

2.2.24. UE910 V2 Interface CS1467D

Length	92,00 mm
Width	107,00 mm
Height	25,00 mm

2.2.25. CL865 Interface CS1531B

Length	92,00 mm
Width	89,00 mm
Height	25,00 mm

2.2.26. GE866-QUAD Interface CS1582

Length	92,00 mm
Width	89,00 mm
Height	25,00 mm



2.2.27. UL865 Interface CS1531B

Length	92,00 mm
Width	89,00 mm
Height	25,00 mm

2.2.28. LE910 Interface CS1467F

Length	107,00 mm
Width	102,00 mm
Height	25,00 mm



NOTE:

The overall height for every combination (mother board + interface board) is still the height of the mother board



3. Startup procedure

The motherboard factory setup is:

Serial port	RS232
DC source	+ (5÷40) V / ≥ 1A
Batt.Charger connector (PL106)	On
RX Amplifier	Audio 1

Respect the following order to use the EVK2:

- insert your SIM card
- set properly all jumpers in the desired position
- plug the module Interface board into PL201 and PL202
- connect the antenna to RF connector (on module or on Interface Board)
- connect the audio accessories if required
- plug the external power supply into the right socket, depending from DC source
- switch ON the power supply
- connect the serial cable between your PC and UART (RS232 or USB 1.1)
- push ON/OFF button on EVK Board for at least 5 seconds, on the XX910 form factor products, push ON/OFF button on Interface Board for at least 5 seconds until the STATUS LED is on

Your EVK2 should now be operational and ready to receive AT Commands.



NOTE:

When you use USB port, it is very important to respect the following sequences:

Start: first turning ON the EVK2 and then connecting it to the PC

Stop: first disconnecting the PC and then turning OFF the EVK2



4. Insertion of the Interface Boards

Every *Interface Board* must be inserted on *CS1139B* paying great attention to match the position of the main connectors; this has been made easy:

optically by a triangle drawn on both printed circuits (except CS1231X) ;
mechanically shifting a column out of regular square cross position.

Both guide systems are highlighted by orange color as shown on the next figure.

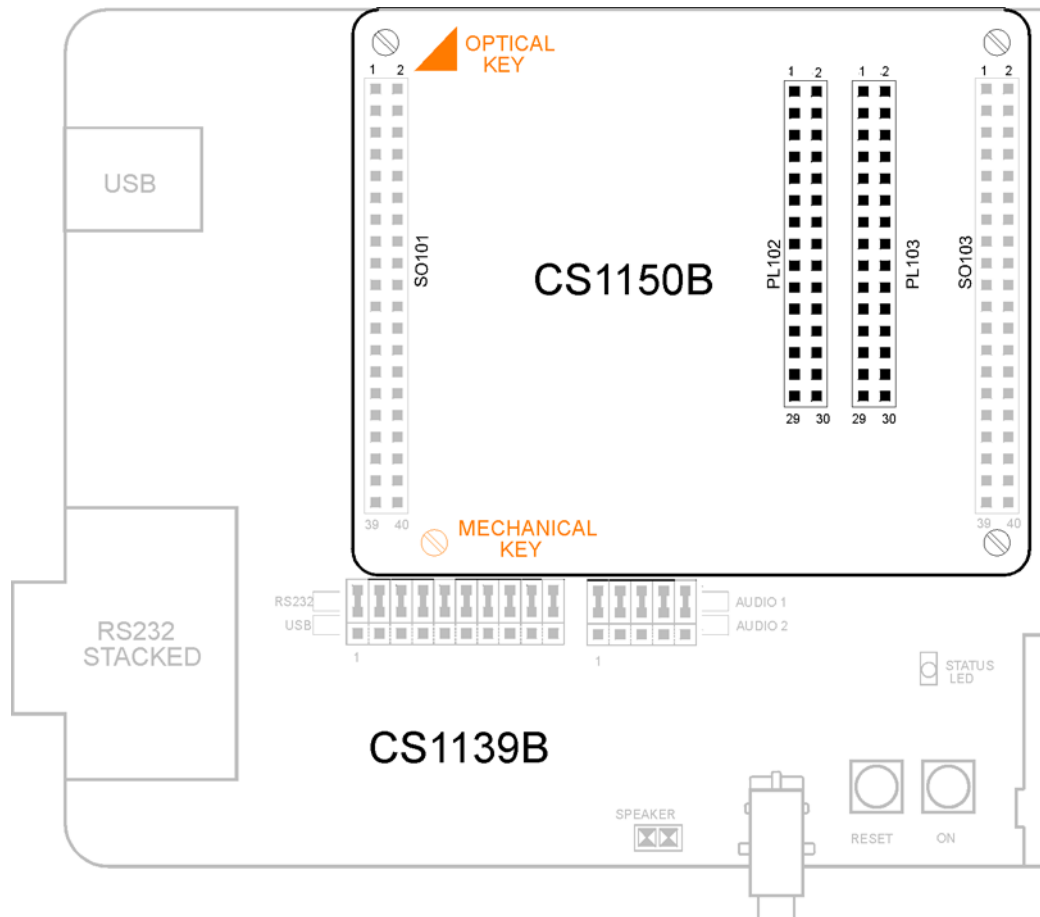

Positioning Guide Systems of *GM862 Interface Board* on CS1139B.



5. Power supply setting

The **EVK2** could be powered by different external sources, only one at time. The requested setting is made inserting the proper jumper connectors in the right position as described in the following paragraphs.

Be careful to the connections, even if every supply line is protected by a diode against “*polarity reversing*” and by a 0Ω resistor against “*short circuiting*”.

5.1. Fixed DC source

Connect a **+3,8V / $\geq 2A$** fixed DC source to PL101 respecting the polarization; short *pin2* & *pin3* – PL104 and *pin1* & *pin2*- PL105 by 2 contacts jumper connectors. No other jumpers are needed.

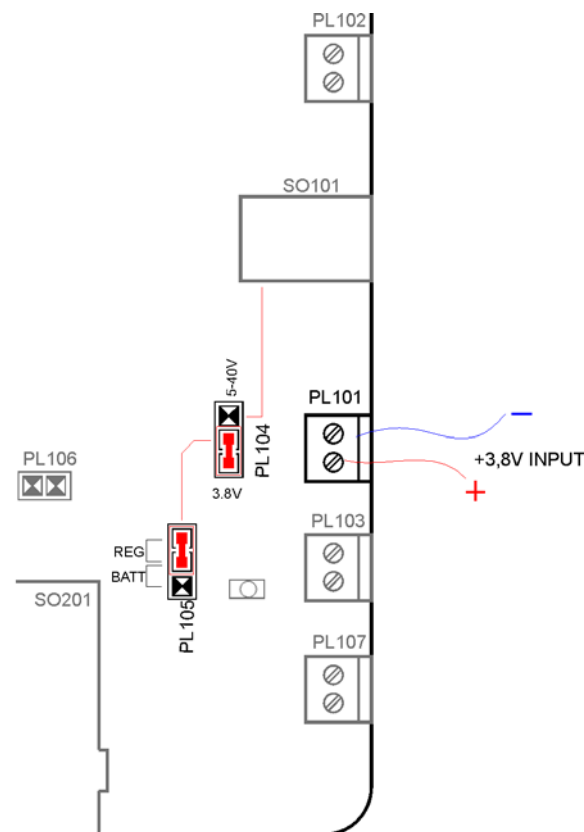

+3,8V fixed source setting



5.2. Variable DC source

Connect a $+5\div 40\text{ V} / \geq 1\text{A}$ variable DC source to PL102 (by wires) or to SO101 (by coaxial plug), with care to the polarities. Short *pin1 & pin2-PL104* and *pin1 & pin2-PL105* by inserting 2 contacts jumper connectors. No other jumpers are needed.

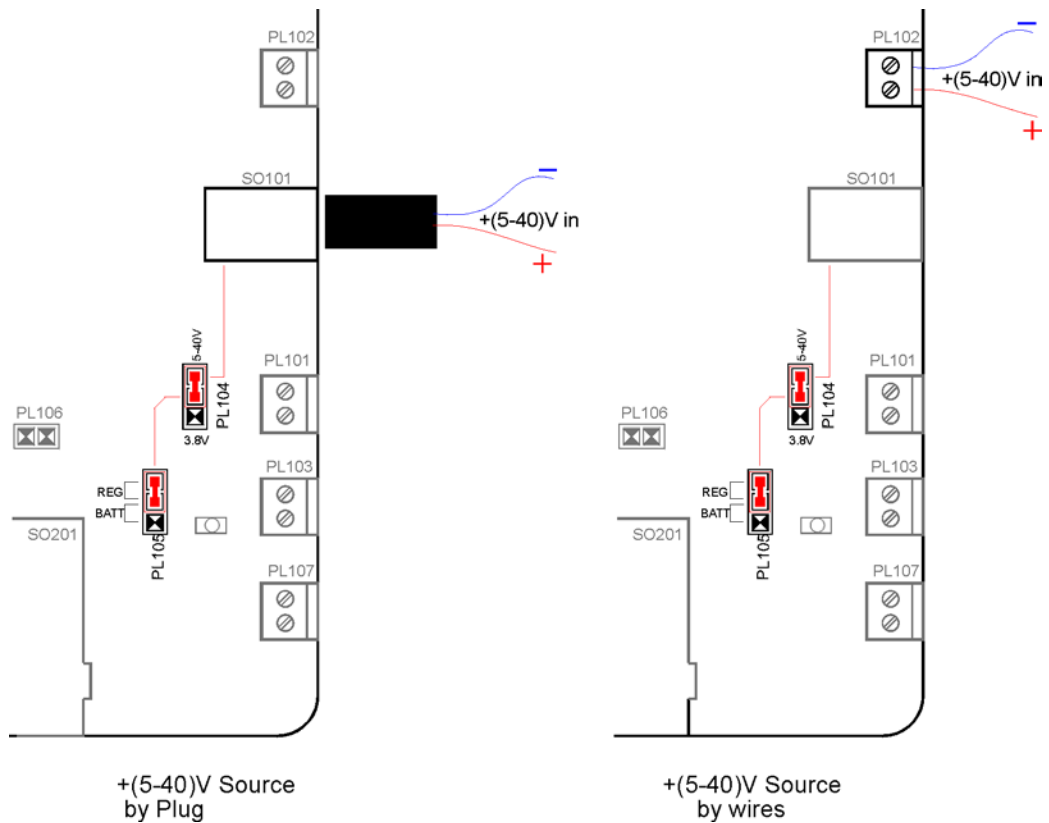

Variable DC source setting



NOTE:

It is useful set the variable DC source at 6V minimum to avoid problems with voltage drops due to the length of the wires or the conductors gauge.



5.2.1. Coaxial Plug

The figure 7 shows the connections of the Power Plug of left part of figure 6.

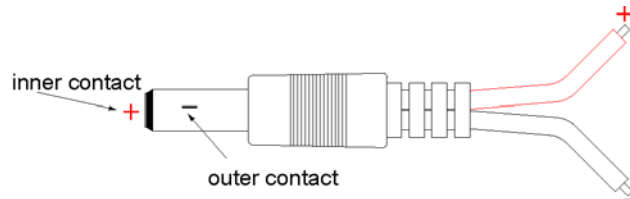

Coaxial “Power Plug” connection.

5.3. Li-Ion Battery pack and Charger

Connect a **Li-Ion battery pack** to PL107 with care to the polarity then short *pin 2& pin3-PL105* by inserting the *2 contacts jumper* connector.

If the battery pack needs to be recharged, connect a **+6V / ≥0,5A** fixed DC source to PL103, with care to the polarity; short PL106 inserting a *2 contacts jumper* connector as shown in figure 8: the yellow CHARGE LED will be on during the initial phase of charge. If you remove the battery pack when the charge stops (no current flows), immediately **REMOVE** also the jumper of PL106.

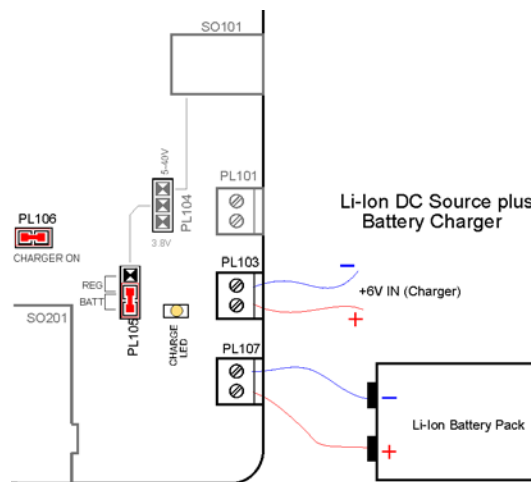

Battery Pack and Battery Charger wired connections and setting.



WARNING:

NEVER CONNECT any Battery Charging source to PL102 without connected Battery!!



5.4. Application Notes

5.4.1. Li-Ion Battery Pack

The 3.7V Li-Ion rechargeable Battery Pack should be connected directly to PL107 connector. Remember to use the connection cables as short as possible, with the appropriate conductors gauge and the other attributes, such as device power budget and cable flexibility, in order to match the specified voltage drop (especially during the high current absorption periods). To obtain the best performance we suggest a capacity of **1000 mAh** (not lower than 500 mAh).

5.4.2. About Current Charger

With a **+6V Current Unlimited Source** connected to PL103 connector, the battery pack will be directly charged through *VBATT connector pins* of the Telit Modules, under control of the *Internal Charge Algorithm* (only on models where is implemented).

Depending of the size, the Li-Ion cell manufacturers suggest a charge current value not greater than $1,5C$ (C= Capacity of the battery pack, expressed in mAh); even if a lower current means a longer charging time, a current equal to $0,5C$ is considered to be a good choice.

With reference to the schematic diagram *30276SE11139A –sheet1*, the Current Limiting Circuit (*Q102, Q103, R106, R107, R108, R109, R110, R111, R112, R113, C105*) sets the maximum value of the Charge Current in respect to the law:

$$I_{ch} = \frac{V_{be}Q102}{R_{par}} \rightarrow \text{where}$$

$$R_{par} = //R110, R111, R112, R113$$

With the default values, the charge current will be $\sim 470\text{mA}$, which will charge Battery Packs with a capacity from 350mAh to 1000mAh, **without any dissipation problem**.

If a higher capacity Battery Pack is needed, you must increment the Time Out in the Telit Modules.



WARNING:

SET THE MAXIMUM VOLTAGE OF the CURRENT UNLIMITED SOURCE LOWER than +8V.



6. Serial interface

The following figure shows the architecture of the serial ports.

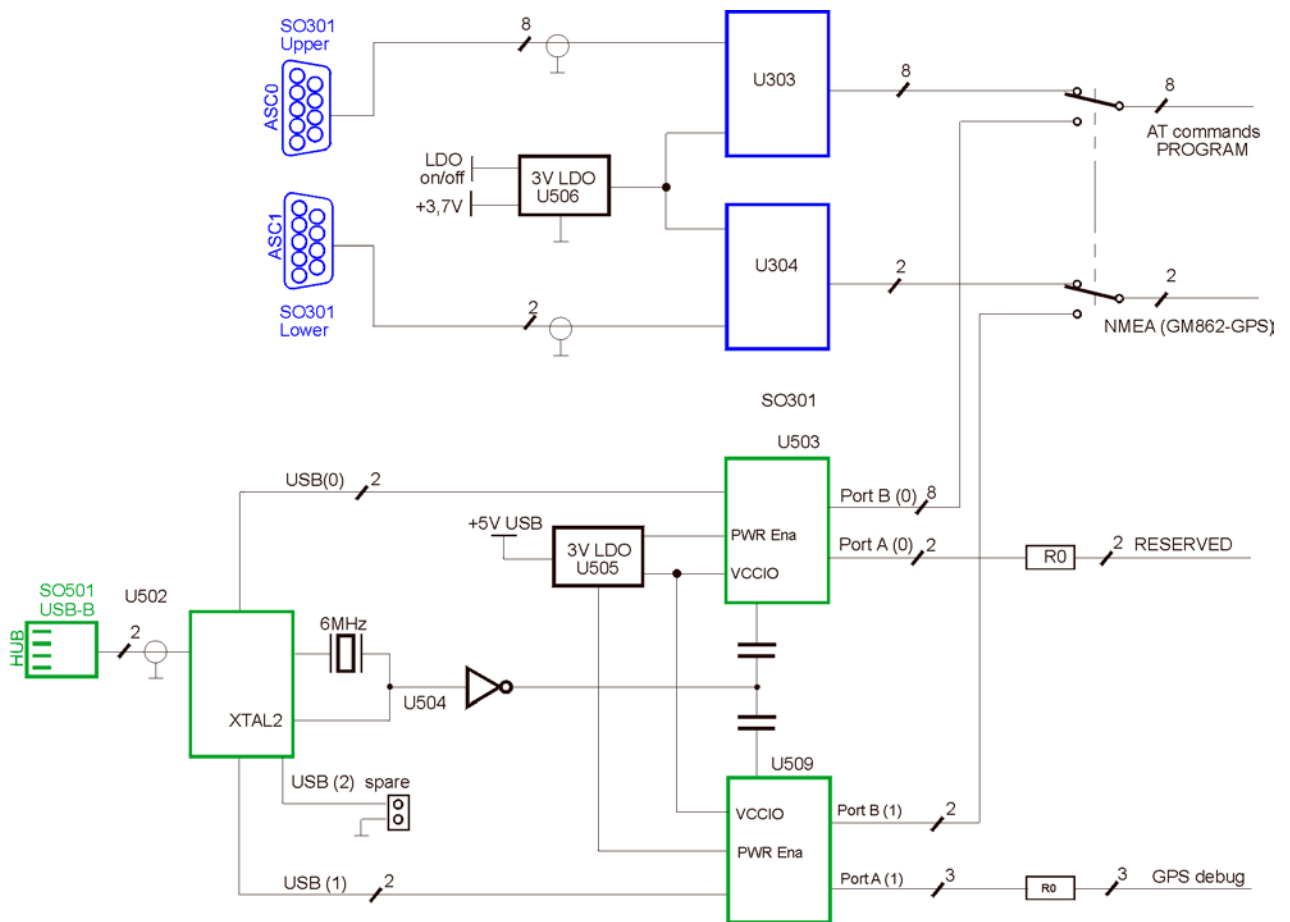

Serial ports block diagram.



6.1. Serial Port Setup

Communications between your application and the Telit modules are allowed connecting the DTE to the *Asynchronous Serial Interfaces* of Base-Band Chip, ASC0 and ASC1, through the *stacked standard RS232 communications port (double 9 way D-socket connector at slow data rates of RS232 protocol)* or a *standard USB-B Series receptacle (at higher data rates of USB1.1 specification through a CMOS HUB that realizes a multiple attachment point device)*.

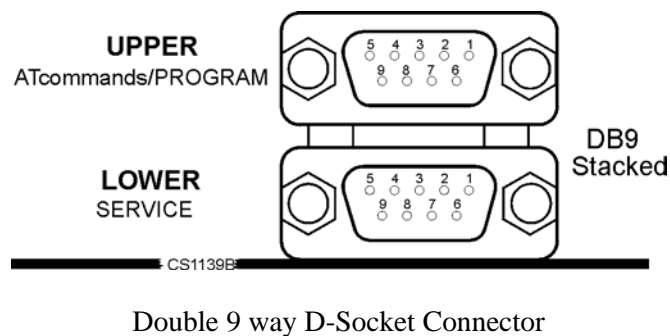

The selection is made short circuiting *PL302&PL303 (RS232 mode)* or *PL302&PL301 (USB 1.1 mode)* by 10 pieces of 2 contacts jumpers. This solution has been implemented because you can isolate every single line during the development.

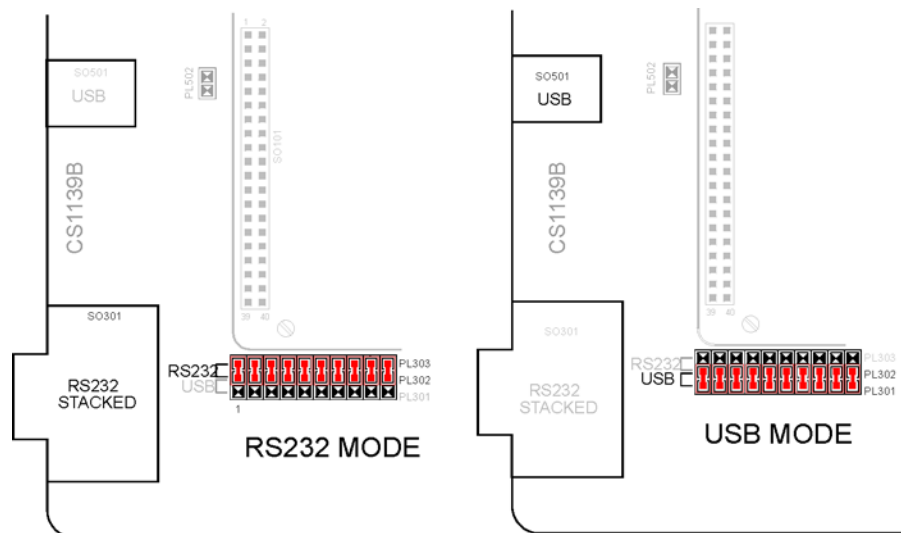

Serial Ports selection



7. Audio Section

7.1. Overview

The Base Band chip of the Telit’s modules provides one or two (depends of model) audio paths both in receive and in transmit sections, which could be active only one at time.

To turn on your well-suited section on EVK2, please refer to “*AF Amplifiers Setting*” paragraph and followings.

To know which are the suggested performances of the EVK2 audio transducers, refer to “*Audio Accessories*” paragraph.

7.1.1. History

The Baseband chip of our modules was developed for the cellular phones, which needed two separated amplifiers both in RX and in TX section. A couple of amplifiers had to be used with internal audio transducers (Handset mode, *HS*) while the other couple of amplifiers must be used with external audio transducers (Handsfree mode, *HF*).

Transducers definitions:

Headsets are transducers that receive an electrical signal from a receiver and use speakers placed in close proximity to the ears to convert the signal into audible sound waves.

In the context of telecommunication, the word *Headset* is also commonly understood to refer to a combination of *Headphone* and *Microphone* used for two-way communication, like with a mobile phone.

Earphones are small Headphones that are placed directly outside of the ear canal, but without fully enveloping it. They are generally inexpensive and are favored for their portability and convenience.

Earpiece A part whether of a telephone receiver or hearing aid, that fits in or is held next to the ear.



7.2. Actual

The *HS* and *HF* definitions have been kept in the Software and on the schematics of the Telit modules, but with EVK2 we will refer to *Audio1* and *Audio2* section instead of *Handset* and *Handsfree* respectively, remembering that:

they can have fully equivalent electrical performances (*like the two microphone amplifiers*)
 they can activate the same functionalities (*like the Echo Canceller module*)
 they can offer slightly different performances (*like the two speaker buffering stages*)

7.2.1. The choice

The activation of the audio path is made Hardware by **AXE** line or Software by **AT#CAP** command.

If you don't have any load driving constraint (*like a speaker with an impedance coil lower than 16 ohm*), the choice between one or other “*block*” could be done without consideration related to the electrical performances; for example in order to overcome the PCB design difficulties.

7.3. Differential and Single Ended

7.3.1. Concepts

Any voltage can be characterized by a potential difference between two terminals.

The configuration of the two terminals and how the signal is delivered from output to input allows the signal to be more generally described in one of three ways:

Single-ended signal. This is a signal delivered between a signal trace and a ground. One terminal for a single-ended connection is always at fixed potential (*usually Ground*).

Differential Signals. These are signals that travel through a pair of traces. On the signal pair, neither of the terminals is Ground.

Common mode Signals. They represent a special case of differential signals, also travelling between a pair of traces, where the voltage potential on both signals is the same.



7.3.2. Benefits and disadvantages

Differential amplifiers are desirable to use, especially in audio applications where signal levels are very low such as those from microphones.

Classically, the benefits obtained from differential amplification are:

Increase of Common Mode Rejection Ratio (CMRR)

Differential inputs enable cancellation of any noise common on both inputs. Noise generated at the input of the amplifier has a greater effect than noise generated at the output, because any noise on the input is multiplied by the gain of the amplifier.

Increase Signal to Noise Ratio (SNR)

The inputs to the amplifier are especially sensitive to noise because they are typically not driven by a very low impedance source.

High Rejection in Electromagnetic Interference (EMI)

Noise immunity is very important in wireless phones because the RF signal is sent in bursts such that the frequency between bursts is in the audio band. RF rectification is such a problem that many manufacturers shield the audio portion of the phone.

Double Useful signals level

The signal levels from microphone and the voltage swing to the load are doubled. Then the AF power to the load it is 4 times the single-ended Afpower at the same voltage supply.

No output blocking capacitor is needed

Even if the differential outputs are biased at half-supply; no DC voltage exists across the load. You do not need the big, expensive and heavy blocking capacitors (generally from 33 μ F to 1000 μ F), lowering the cost and saving PCB space

There is no frequency limiting effect due to the high pass filter network created with the speaker impedance and the coupling capacitance.

Less shielding is required from amplifier to load

Mainly we have only one disadvantage using differential amplification: the routing of one more signal line could be more difficult and the additional trace requires more board space.



7.3.3. Settings

Connecting your accessories to *SO401 in/out connector*, you will implement Single Ended Input/Output configurations.

Removing all 2 *contacts jumpers* inserted between *PL402&PL403* or *PL403&PL404*, the *in/out lines* of our modules will be directly available on *PL402* and *PL404* connectors.

In such a way, you will be able to implement fully Differential Input/Output configurations. Only with GC864-QUAD/PY-C2 modules the *Ear output* lines are AC coupled.

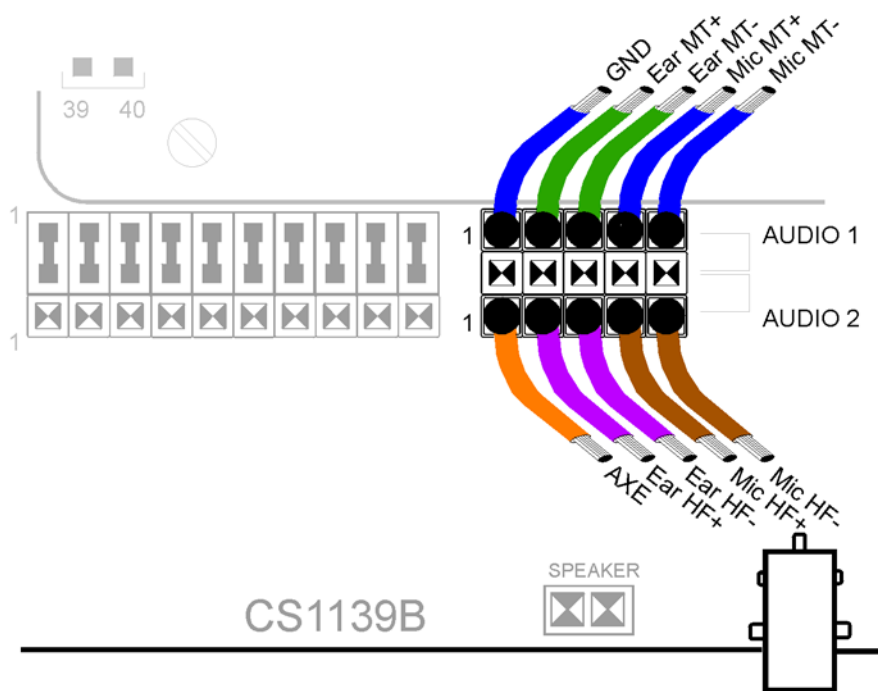

PL402 and PL404 Fully Differential audio lines.



8. AF Amplifiers Setting

The *Base Band Processor Audio Amplifiers* selection is made short-circuiting *PLA03&PLA02* (*RX Amplifier 1*) or *PLA03&PLA04* (*RX Amplifier 2*). In such a way you could verify the complete performance of both audio paths.

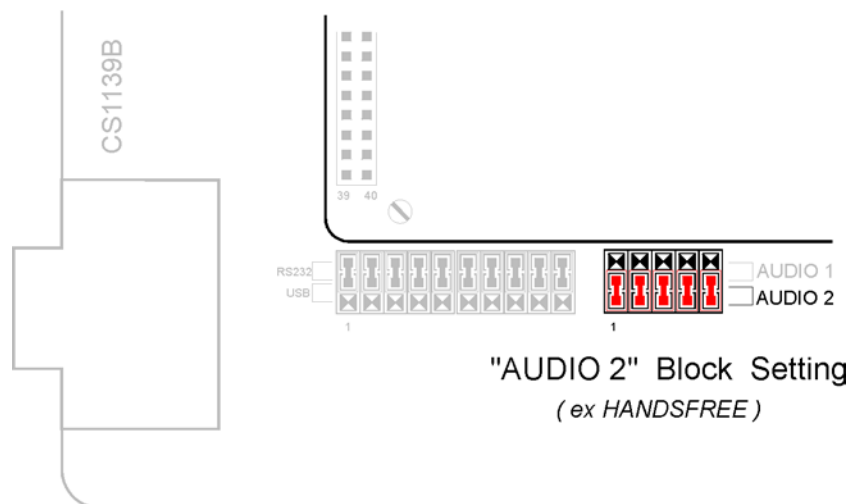
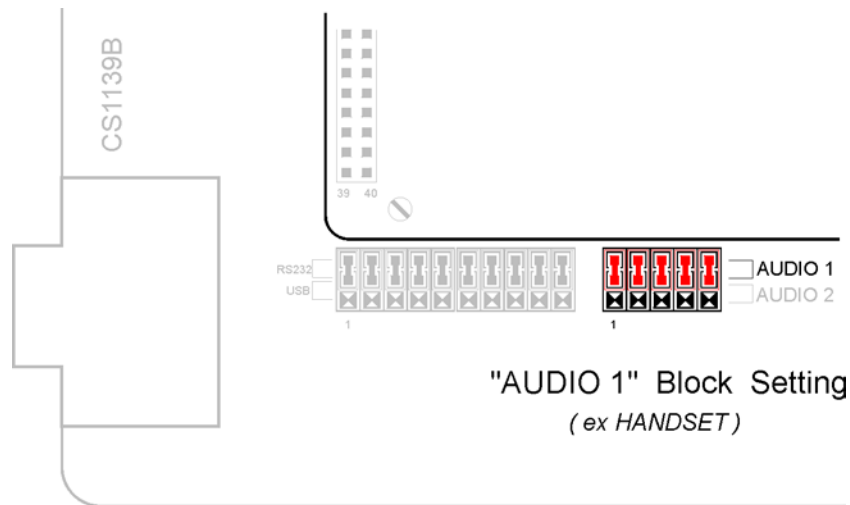

Base Band Audio Amplifiers selection



9. Audio outputs

The EVK2 output audio signals could be drive a device connected to *SO401* (LOW AF POWER mode) or to *PLA01* (HIGH AF POWER mode).

9.1. Low AF Power Mode

Inserting the 2 *contacts jumpers* as explained at paragraph 9A, a standard *off-the-shelf Headset* should be connected to the *SO401* (3 contacts, 2.5mm diameter jack connector).

With such an insertion, the Telit Modules will power the Microphone through a Single Ended input circuit and the Earpiece through a Single Ended/ AC coupled output circuit.



NOTE:

The acoustic performance of the *Headset* (*frequency response, loudness*) largely depends by its housing, fitting and acoustic impedance.

The coil impedance of the Headset should be higher than 15 ohm @ 1KHz.

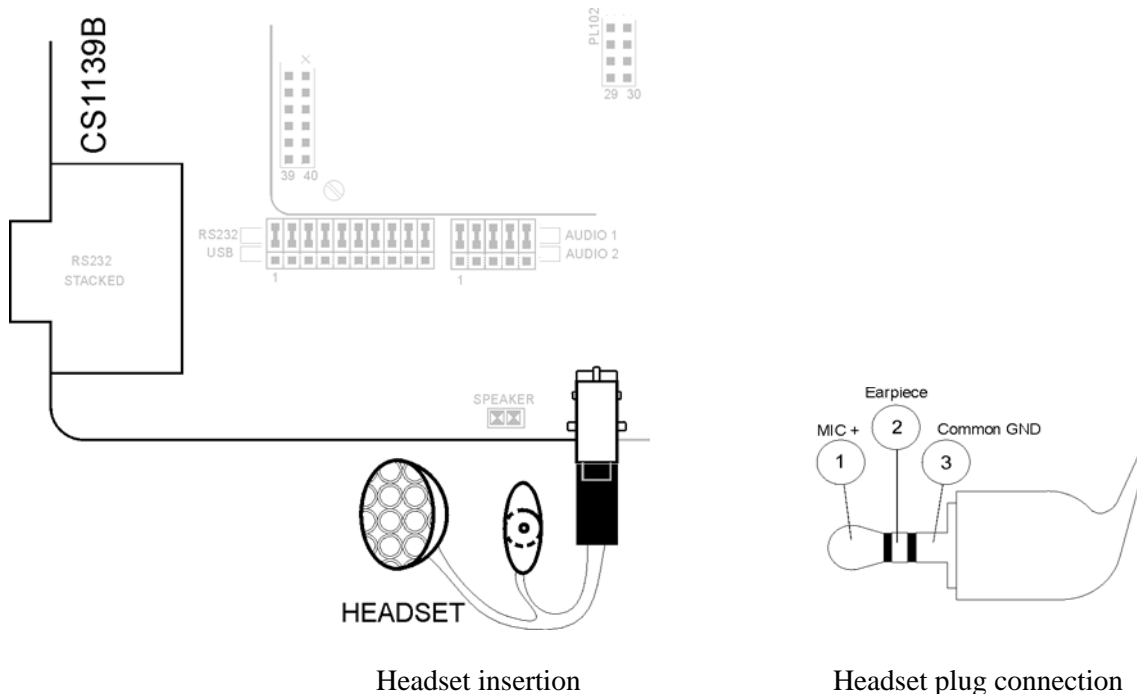

9.2. High AF Power Mode

Connecting an **8 ohm** Speaker to PL401 by a 2 contacts female connector, you could drive it through the 500mW Power Amplifier.

In this case the Speaker will be driven in fully differential configuration, with no side connected to ground and without any output coupling capacitor. Therefore care must be taken because there is DC voltage on both sides of the Speaker.

The overall gain of this amplifier can be modified varying the ratios R406/R404 and R407/R410:

$$A_v = 2 \cdot \frac{R404}{R406} = 2 \cdot \frac{R407}{R410} \quad \text{if } R404=R407 \text{ and } R406=R410$$



NOTE:

The coil impedance of the Speaker should be higher than 8 ohm @ 1KHz .

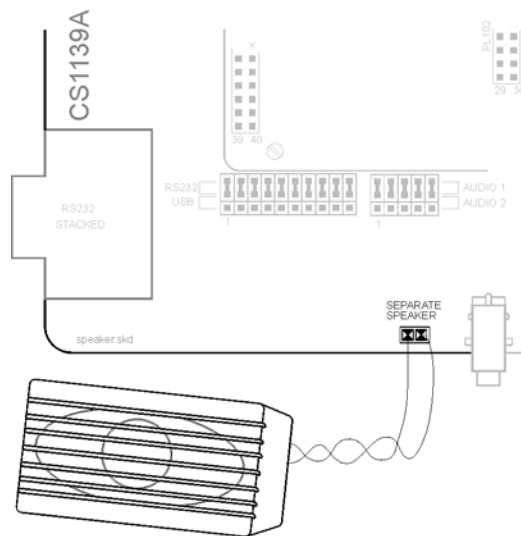

Speaker insertion



9.2.1. Speaker and Stand-alone Microphone

If you are using a Speaker, you can connect a *stand-alone electrete microphone* by a coaxial 2,5mm plug to SO401, respecting the following pin-out.

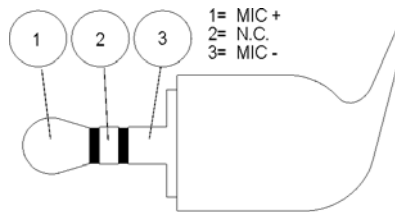
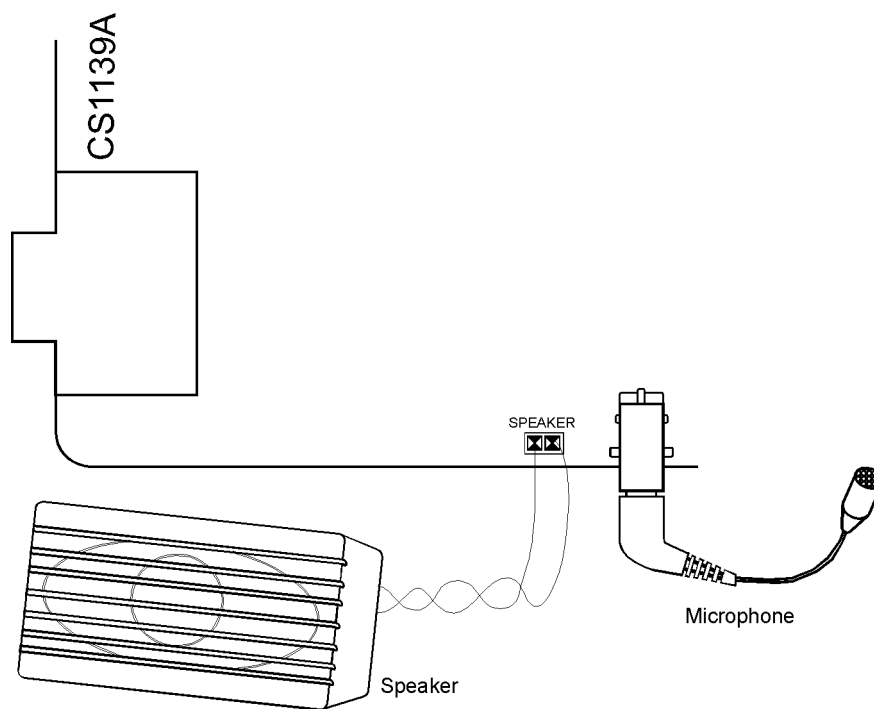

Figure 1: Microphone Plug Connection



Speaker & Microphone case insertion



9.2.2. Speaker plus Headset

If you have chosen to connect the Speaker to *HIGH AF POWER* output, without having a stand-alone electret microphone, it is also possible to connect a standard *off-the-shelf Headset* to SO401 without any problem, as shown in the figure 18: the AF output signal will be heard on both Speaker and Earpiece.



WARNING:

You must use the right coil impedance depending from audio output you want to use.

If you sort out the *LOW AF POWER* solution connecting your Headset to SO401, the coil impedance **must be at least 16Ω@1KHz or higher**.

If you sort out the *HIGH AF POWER* solution connecting your Speaker to PL401, the coil impedance **must be at least 8Ω@1KHz or higher**

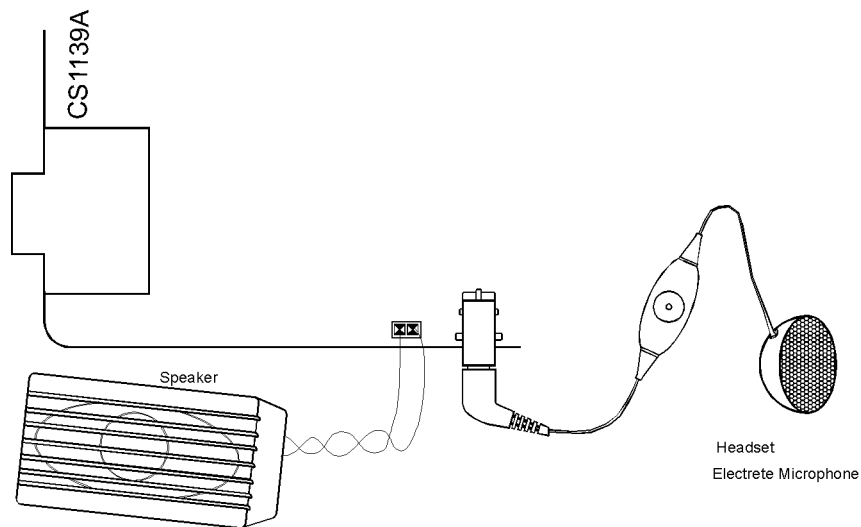

Speaker plus Headset insertion



10. Audio Accessories

The following tables show the suggested specification to obtain the best performance from *off-the-shelf* accessories.

10.1. Headset

Microphone electrical characteristics	
Nominal sensitivity	-45dBV _{rms} /1Pa (+/- 3dB)
Line coupling	AC
Nominal Voltage	2V
Range of Using Voltage	(1÷10)V
Consumption Current	(150÷500) μA
Impedance	2,2KΩ
Signal to Noise Ratio	56dB /1KHz/1Pa (A curve)
Inner EMI capacitor between terminals	10pF, 33pF

Earpiece electrical characteristics	
Rated Input Power	5mW
Maximum Input Power	20mW
Coil Impedance	32Ω ± 5Ω @ 1kHz
SPL	95±3 dB @ 1KHz/1mW sine wave
Resonance frequency (Fo)	< 350Hz
Useful Bandwidth	Fo ÷ 8000 Hz @ -3dB



10.2. Stand-alone microphone

Microphone electrical characteristics	
Nominal sensitivity	-45dBV _{rms} /1Pa (+/- 3dB)
Line coupling	AC
Nominal Voltage	2V
Range of Using Voltage	(1÷10)V
Consumption Current	(150÷500) μA
Impedance	2,2KΩ
Signal to Noise Ratio	56dB /1KHz/1Pa /A curve
EMI capacitor between terminals	10pF, 33pF

10.3. Speaker

Speaker electrical characteristics	
Rated Input Power	500 mW
Maximum Input Power	1W
Coil Impedance	≥ 8Ω
SPL	≥ 85±3 dB @ 1KHz
Resonance frequency (Fo)	< 350Hz
Useful Bandwidth	Fo ÷ 8000 Hz @ -3dB



11. Indication and services

11.1. Optical Indicators

11.1.1. Status Led

It is a debug aid that shows information on the network service availability and Call status.

LED status	Device Status
Permanently off	Device off
Fast blinking (period 1s, Ton 0,5s)	Net search / Not registered / turning off
Slow blinking (period 3s, Ton 0,3s)	Registered: full service
Permanently on	A call is active

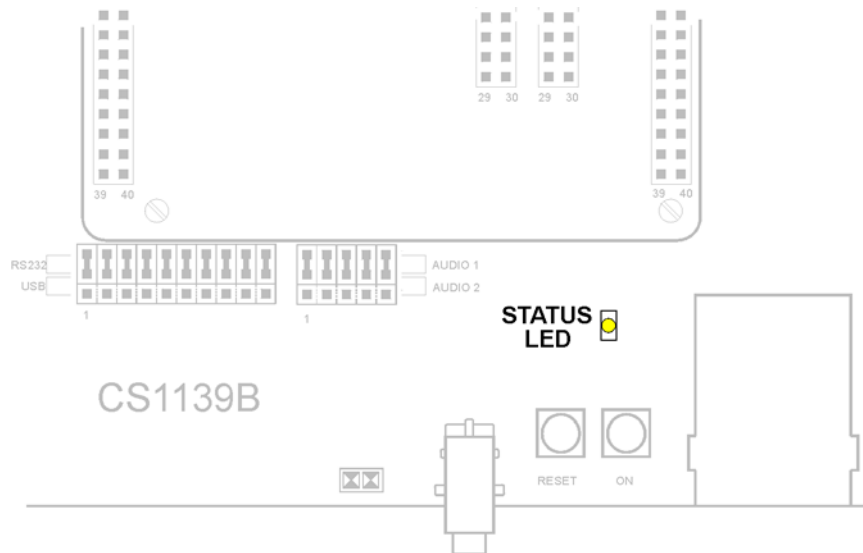

STAT_LED position



11.1.2. CHARGE Led

A yellow LED is used as *Charge In Act* Indicator, as explained in the following table.

CHARGE LED	Meaning
Always on	Start Charge/ Hugh current Charge in act
Always off	Low current Charge in act/Charge stop

Table 7: CHARGE LED indications

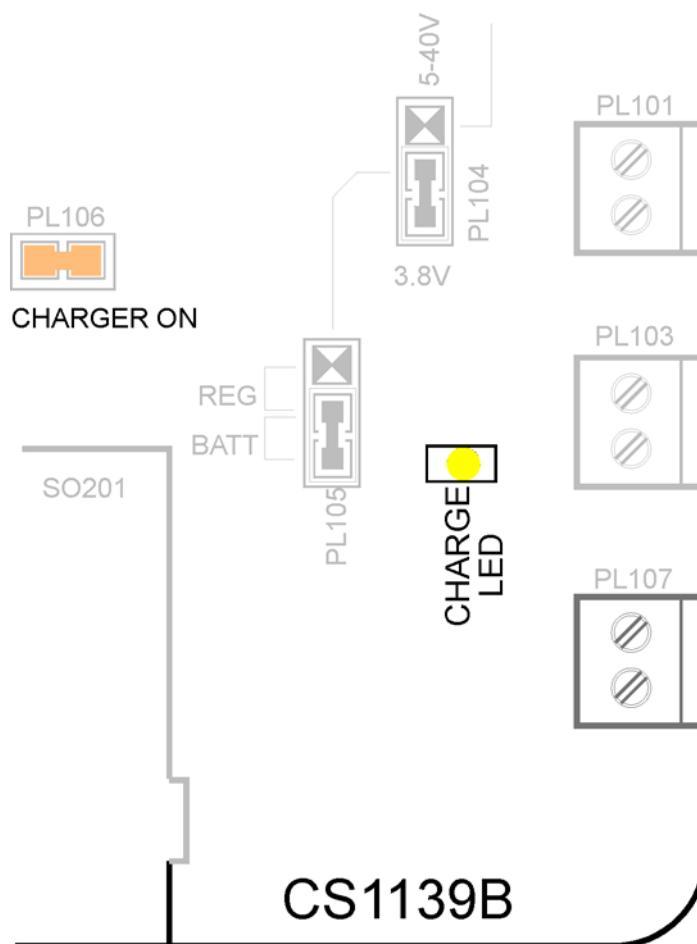

CHARGE LED position



11.2. Switches

You turn *On/Off* or *Reset* the EVK2 by 2 push buttons.

11.2.1. POWER ON Switch

Push ON/OFF button on **EVK Board** for at least 5 seconds, on the XX910 form factor products, push ON/OFF button on **Interface Board** for at least 5 seconds until the STATUS LED starts to slowly blink (*ON state*) or stops to blink (*OFF state*).

11.2.2. RESET Switch

Whenever the RESET SWITCH is pressed, you could reset the Telit module in use. When the device is reset, it stops any operation without doing any detach operation from the network where it is registered and it reboots after the release of the Reset Switch. This behavior is not a proper shut down because any GSM device is requested to issue a detach request at turning off. For this reason the Reset pressing action must not be used to normally reboot/shutting down the device, but only as an emergency exit in the rare case the device remains stuck waiting for some network response. The RESET is internally controlled at start-up to achieve always a proper power-on reset sequence, so there is no need to control this pin on start-up. It may only be used to reset a device already on that is not responding to any command.

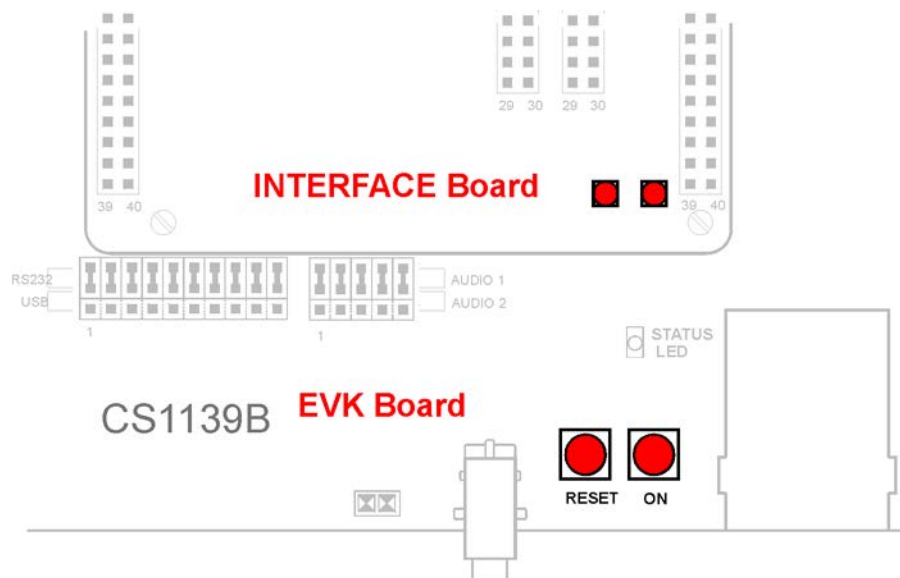

SWITCHES position



12. Connectors pinout

12.1. Motherboard to Module

The connections between CS1139B and every Telit module Interface Board are made through two *40 pin male* connectors. Theirs pin functions are listed in the following tables.

PL201-CS1139B			
Pin	Signal	Type	Function
1	NC ¹		
2	TX_Trace	Digital Output	to RS232 or USB level translators
3	RX_Trace	Digital Input	from RS232 or USB level translators
4	IIC_SDA_HW	Digital In/Out	from/to USB level translators
5	GND	DC voltage	Power
6	IIC_SCL_HW	Digital Input	from USB level translators
7	SSC0_CLK	Digital Output	to USB level translators
8	SSC0_MTSR	Digital In/Out	from/to USB level translators
9	SSC0_MRST	Digital In/Out	from/to USB level translators
10	NC		
11	GND	DC voltage	Power
12	GND	DC voltage	Power
13	GND	DC voltage	Power
14	GND	DC voltage	Power
15	C109/DCD	Digital Output	to RS232 or USB level translator
16	C104/RXD	Digital Output	to RS232 or USB level translator
17	C103/TXD	Digital Input	from RS232 or USB level translator
18	C108/DTR	Digital Input	from RS232 or USB level translator
19	GND	DC voltage	Power
20	C107/DSR	Digital Output	to RS232 or USB level translator
21	C105/RTS	Digital Input	from RS232 or USB level translator
22	C106/CTS	Digital Output	to RS232 or USB level translator
23	C125/RING	Digital Output	to RS232 or USB level translator
24	NC		
25	GND	DC voltage	Power
26	GND	DC voltage	Power
27	GND	DC voltage	Power
28	GND	DC voltage	Power
29	EAR_HF+	AC Out Voltage	Audio
30	EAR_MT-	AC Out Voltage	Audio

¹ DO NOT CONNECT



31	EAR_HF-	AC Out Voltage	Audio
32	EAR_MT+	AC Out Voltage	Audio
33	AXE	DC voltage	INT/EXT Switching
34	MIC_HF-	AC In Voltage	Audio
35	MIC_MT+	AC In Voltage	Audio
36	MIC_HF+	AC In Voltage	Audio
37	MIC_MT-	AC In Voltage	Audio
38	GND	DC voltage	Power
39	GND	DC voltage	Power
40	GND	DC voltage	Power

PL202-CS1139B			
Pin	Function	Type	NOTES
1	VBATT	DC voltage	Power
2	VBATT	DC voltage	Power
3	VBATT	DC voltage	Power
4	VBATT	DC voltage	Power
5	GND	DC voltage	Power
6	GND	DC voltage	Power
7	GND	DC voltage	Power
8	GND	DC voltage	Power
9	CHARGE	DC voltage	Power
10	CHARGE	DC voltage	Power
11	GND	DC voltage	Power
12	GND	DC voltage	Power
13	GND	DC voltage	Power
14	GND	DC voltage	Power
15	ON_OFF*	DC voltage	Pull up to VBATT
16	NC		
17	RESET*	DC voltage	Module Reset
18	NC		
19	NC		
20	NC		
21	STAT_LED	Open Collector	Status Indicator LED
22	NC		
23	NC		
24	NC		
25	GND	DC voltage	Power
26	GND	DC voltage	Power
27	GND	DC voltage	Power
28	GND	DC voltage	Power
29	NC		
30	NC		
31	SIMIO	3V Only	SIM Data I/O
32	SIMCLK	Digital Signal	SIM Clock



33	SIMRST	DC voltage	SIM Reset
34	SIMVCC	DC voltage	SIM Power
35	SIMIN	DC voltage	SIM inside detector
36	NC		
37	NC		
38	GND	DC voltage	Power
39	GND	DC voltage	Power
40	GND	DC voltage	Power



13. Module Interface Boards

13.1. Generality

You can use your **EVK2** with see **APPLICABILITY LIST** Telit modules fitted on its own *Interface Board*; all connections are made through *2x40 contacts* connectors.

It's possible to use these *Interface Boards* also in stand-alone mode, inserting the “*not mounted*” components (*related to RESET BUTTON, ON BUTTON, SIM HOLDER and STATUS LED functions*) plus the use of an external *level translator* circuit.

For more information refer to Telit Product Description.

13.2. Short Description

The interface boards convert the module connection technology (*board-to-board or BGA soldering*) into a PTH pin connector. The part of the basic interfaces is served by the motherboard, whereas specific interfaces according to the type of the module (*antenna, general purpose inputs/outputs GPIO, ADC/DAC, UART*) are available on the adapter board to connect it to the user applications, extension boards, measurements equipment or other tools.

13.3. Further Accessories for GPS version

When test the GPS products, besides the content of the single kits you need the accessories listed in below table.

SMA/MMCX cable adapter	Module under test	Interface Board	GPS Antenna
1ff1400073tlb		P/N	1rr0100071tlb
1	GM862-GPS	3990250670	1
-	GE863-GPS	3990250671	1
-	GE864-GPS	TBD	1
-	SE867-AGPS	TBD	1
-	HE910	3990250845	1



14. GM862 Interface

This board allows easily interfacing the module with the EVK2 and testing its functionalities; any version of GM862 can be insert.
No settings are needed.

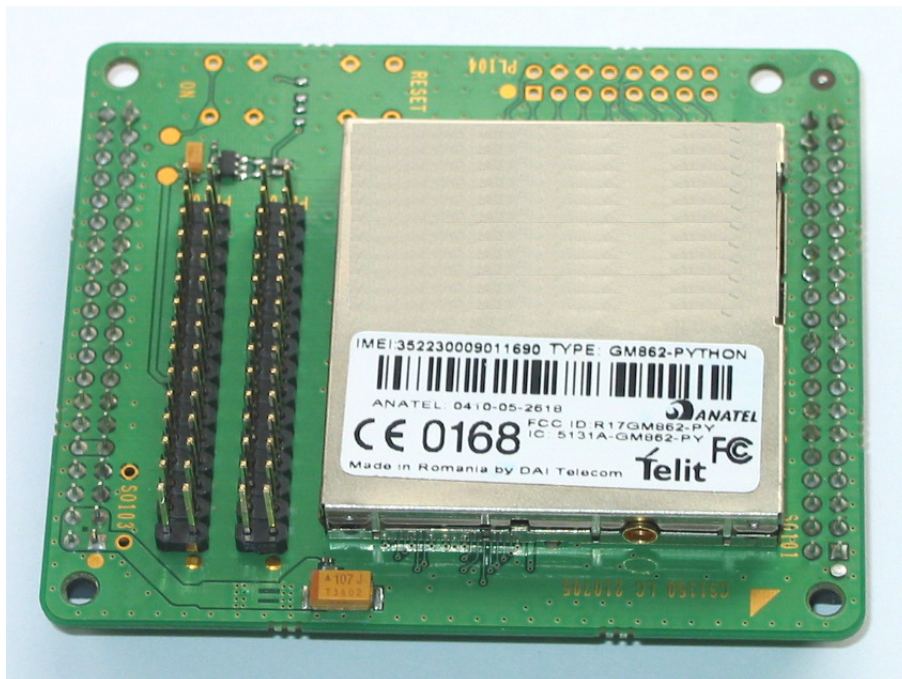

GM862 Interface Board

14.1. Stand-alone setup

If you need to use the interface out of EVK2 (*Stand-alone* setup) you have to mount the following missing components:

- RESET Button
- ON Button;
- STATUS LED and its load resistance.



14.2. Interface connectors

The following connectors are available:

2 male connectors (30 pins each one: PL102, PL103), on which it is possible to connect external devices like user's application, Telit extension boards, measurements equipment or other tools

2 female connectors (40 pins each one: SO101, SO102), to connect the interface to the EVK2 mother board circuits (power supply lines, serial in/out lines, audio in/out lines).

14.3. Content of the kit

Please check out the contents of your interface kit; if any of the items is missing, please contact your supplier.

Description	Quantity
GM862 INTERFACE	1
ASSEMBLED CABLE L-250 RG174 TERMINALS SMA F & MMCX 90 M	1



15. GE863 Interface

This board allows easily interfacing the GE863 modules with the EVK2 and testing their functionalities;



GE863 Interface Boards: GE863-QUAD or GE863-SIM (at left) and GE863-GPS (at right)

15.1. Stand-alone setup

If you need to use the interface out of EVK2 (*Stand-alone* setup) you have to mount also:

- the SIMCARD Holder;
- the RESET Button
- the ON Button;
- the STATUS LED and its load resistance.



15.2. Content of the kits

Please check out the contents of your interface kit; if any of the items is missing, please contact your supplier.

15.2.1. GE863-PY/QUAD version

Description	Quantity
GE863 INTERFACE BOARD	1
2 PIN JUMPER FEMALE CONN	2

15.2.2. GE863-GPS version

Description	Quantity
GE863-GPS INTERFACE BOARD	1
2 PIN JUMPER FEMALE CONN	2

15.2.3. GE863-SIM version

Description	Quantity
GE863-SIM INTERFACE BOARD	1
2 PIN JUMPER FEMALE CONN	2

15.3. Interface connectors

The following connectors are available in any version:

GSM RF connector (*SMA Female*)

2 male connectors (4 pins each one: PL101, PL102) to select the Serial port configuration
 2 female connectors (40 pins each one: SO101, SO106) to connect the interface to the EVK2 mother board circuits (power supply lines, serial in/out lines, audio in/out lines)
 2 male connectors (30 pins each one: PL103, PL104), on which it is possible to connect external devices like user's application, Telit extension boards, measurements equipment or other tools

15.4. Additional components for GPS version

The following components are available only in GPS version (P/N 3990250671):

GPS RF connector (*SMA Female*)

USB B-type connector and its circuitry (*see schematic 30276SE11151A*)



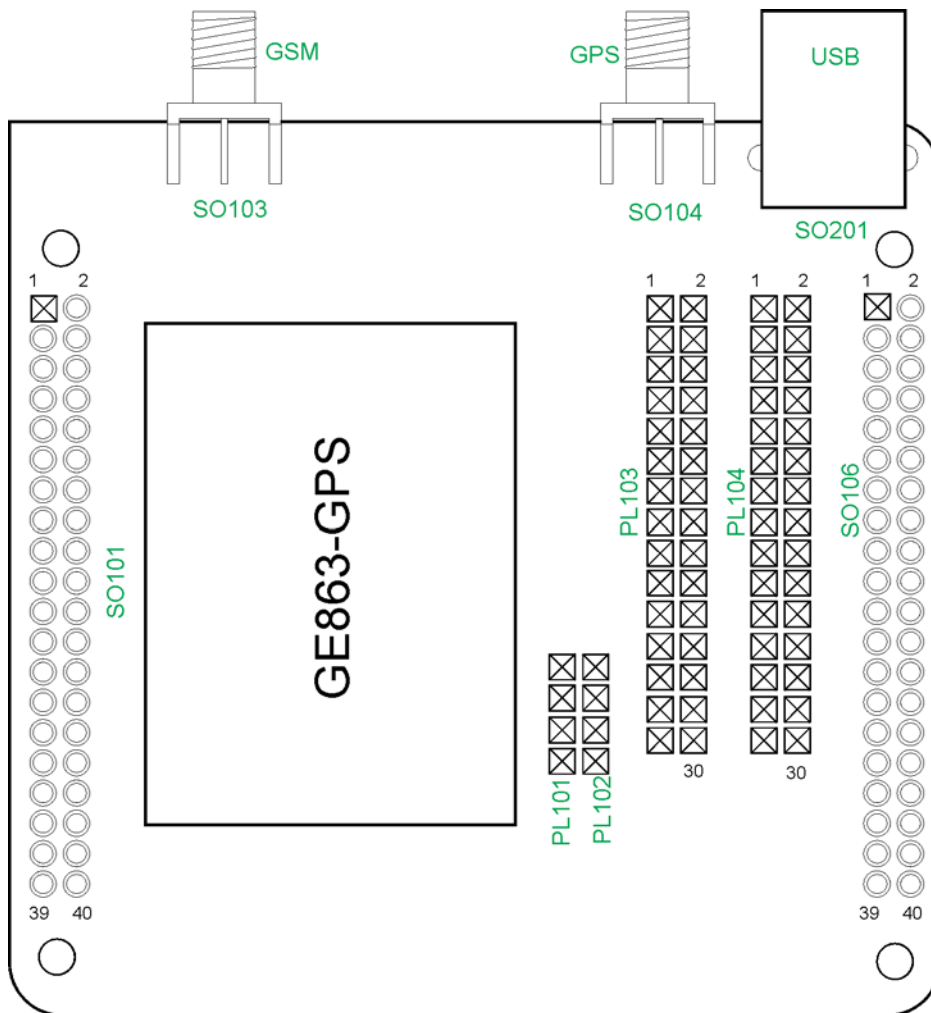

Connectors displacement on GE863-GPS

15.5. USB connector

The USB interface provides 2 serial ports that are related to the *NMEA* serial port and *SIRF-Binary* serial port of GE863-GPS module.

It is possible to select if the *SIRF Binary* serial port will be available on the USB connector or directly connected to the second serial port of the modem (**CONTROLLED MODE**).

For setting refer to paragraphs 16.7.1, 16.7.2.1, 16.7.2.2.



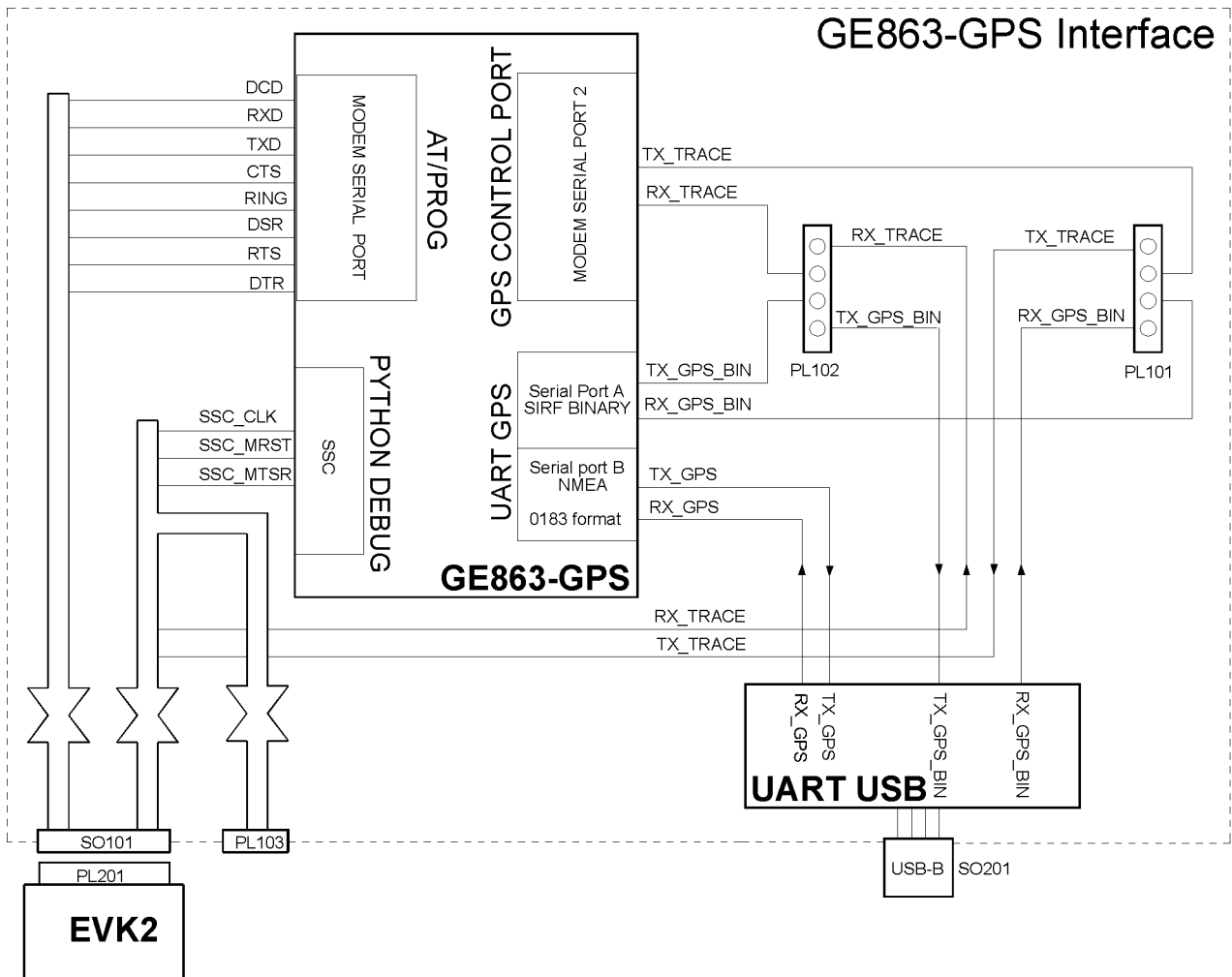

GE863-GPS Serial ports block diagram

15.6. Serial port configuration

To switch the serial lines you must short-circuit the PL101-PL102 connectors by 2 contacts jumpers.



15.6.1. GE863-PY/QUAD

The 2 contacts jumpers have to be fitted between **pin1&pin2** of PL101-PL102 connectors. This carries out the *Python Debug Port* on Trace Port of EVK2.

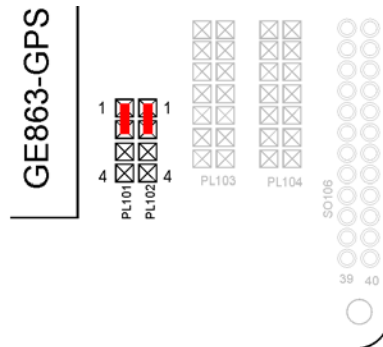

Jumpers setting for GE863-PY/QUAD

15.6.2. GE863 – GPS

The 2 contacts jumpers have to be fitted between **pin2&pin3** or **pin3&pin4** of PL101-PL102 connectors.

“CONTROLLED MODE”

This set the *SIRF Binary* to serial port of the modem. (*Typical application Design*)

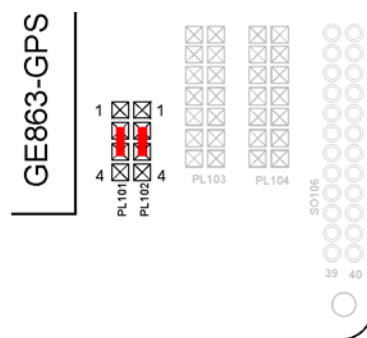

Jumpers setting for SIRF BINARY port connected to MODEM port 2



NOTE: All AT GPS commands are available in this configuration



“SEPARATED SERIAL PORT”

This set the *SIRF Binary* available on the USB connector.

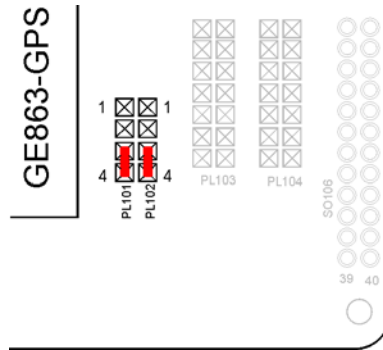

Jumpers setting for SIRF BINARY port available on USB connector



NOTE:

In this configuration some AT GPS commands are not available. Refer to AT Commands Reference User Guide.



15.7. ANTENNA connectors

15.7.1. GPS ANTENNA connector

An active GPS antenna should be connected to SO104; the GPS section provides the DC feeding.



WARNING:

Don't connect a *GSM* antenna on this connector

15.7.2. GSM ANTENNA connector

A GSM antenna should be connected to SO103.

15.7.3. RFU ANTENNA connector

On PCB there is the mounting possibility of a further RF connector (*SO105*): it is related to future implementation.



16. GE864 Interface

This board allows easily interfacing the GE864 modules with the EVK2 and testing their functionalities.

No settings are needed.



GE864 Interface Board

16.1. Stand-alone setup

If you need to use the interface out of EVK2 (*Stand-alone* setup) you have to mount the following missing components:

- the SIMCARD Holder;
- the RESET Button
- the ON Button;
- the STATUS LED and its load resistance.



16.2. Interface connectors

The following connectors are available:

2 male connectors (30 PTH pins each one: PL102, PL103), by which it is possible to connect external devices, user’s application, Telit extension boards, measurements equipment or other tools;

2 female connectors (40 PTH pins each one: SO101, SO102), to connect the interface to the EVK2 mother board circuits (power supply lines, serial in/out lines, audio in/out lines);

16.3. Content of the kit

Please check out the contents of your interface kit; if any of the items is missing, please contact your supplier.

Description	Quantity
GE864 INTERFACE	1



17. GE864-GPS Interface

This board allows testing the functionalities and performance of the GE864-GPS module.



GE864-GPS Interface Board

17.1. Part numbering

This board comes in three different configurations, each characterized by its own part number, depending on the module it contains. In the following paragraphs we will refer to them using an identifier according to the table below:

Part number	Identifier	Module mounted
3990250820	cs1439b	cs1479
3990250821	cs1439b-A	cs1446
3990250822	cs1439b-B	cs1485a



17.2. Stand-alone setup

The interface can be used without the EVK2, in this case the following components have to be soldered on the board:

- the GSM-RESET button
- the GSM-ON button
- the STATUS led and its load resistor.

17.3. Interface connectors

The following connectors are available:

- 2 male connectors (*30 PTH pins each: PL101 and PL102*), to connect external devices, user's applications, Telit extension boards, measurement equipment or other tools; PL102 can also be used to select particular configurations between the GSM module's GPIOs and the GPS module
- 2 female connectors (*40 PTH pins each one: SO101 and SO104*), to connect the interface to the EVK2 mother board (power supply lines, serial in/out lines, audio in/out lines)
- 1 male connector (*3 PTH pins: PL104*), to select an enable signal for the external GPS LNA
- 1 male connector (*2 PTH pins: PL105*), in order to allow inserting an ammeter in series with the supply, in order to monitor the module's current consumption
- 1 GSM RF connector (*SMA Female: SO105*)
- 1 GPS RF connector (*SMA Female: SO103*)
- 1 JTAG connector (*PL103, not mounted*)
- 1 male connector (*12 PTH pins: PL201*), to select one of the available configurations for the Serial and USB ports.

17.4. Contents of the kit

Please check out the contents of your interface kit. If any of the following items is missing, contact your Telit supplier.

Description	Quantity
GE864-GPS INTERFACE	1
JUMPERS	13



17.5. Power supply

The module (but not the whole interface) receives its power supply from PL105: this jumper must always be plugged in, except when a series measurement instrument is needed.

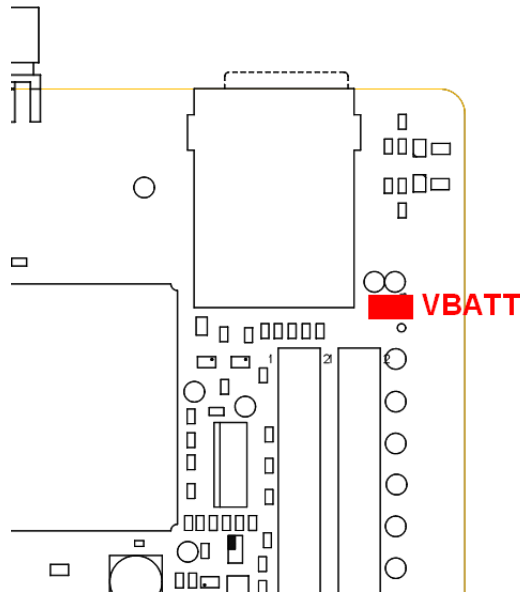

Jumper for VBATT.

17.6. GPS external LNA enable signal

The module contains an internal LNA for the GPS antenna that is enabled by default. The user can though decide to use an external LNA: this option is selected by means of a software command, which puts the internal LNA in a low gain mode and provides an additional signal to enable the external LNA. The interface can provide a bias for the external LNA, and the user can choose whether to enable it by this signal or to leave it always enabled, by means of a jumper on PL104, as shown in the picture below.



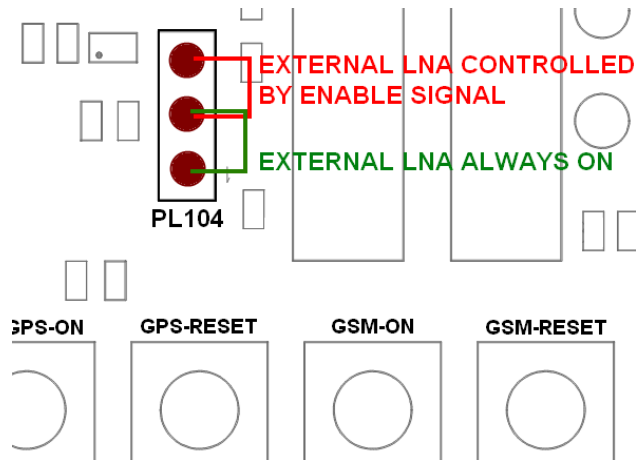

Jumper on PL104.

17.7. Serial port configuration

By means of proper jumper connections on PL201, three different configurations for serial outputs can be selected. These configurations are mutually exclusive.

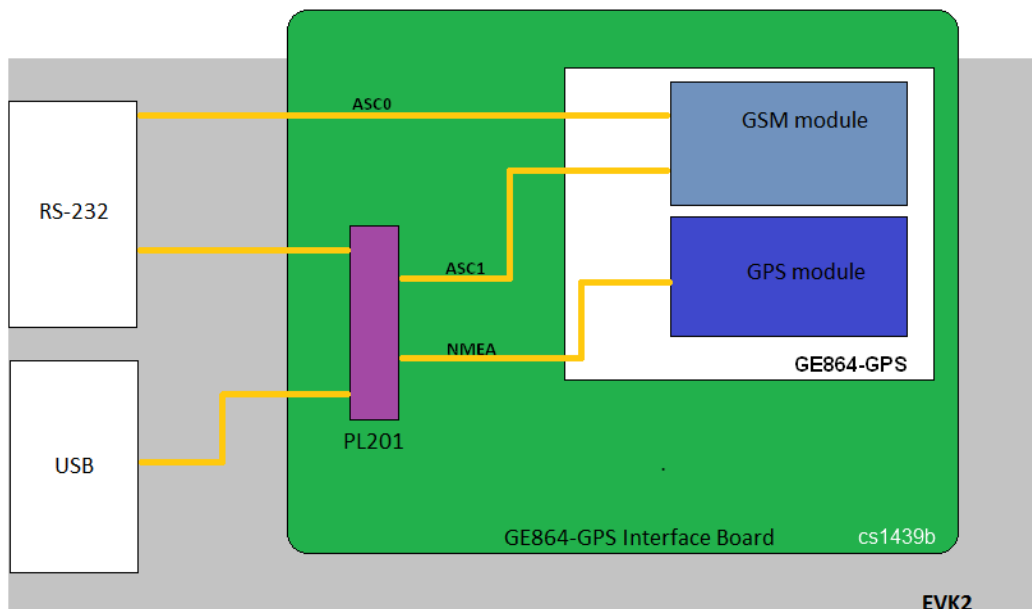

GE864-GPS Interface Board serial connections



17.7.1. ASC1 to RS-232

This configuration connects the ASC1 UART to the Trace serial connector of the EVK2.

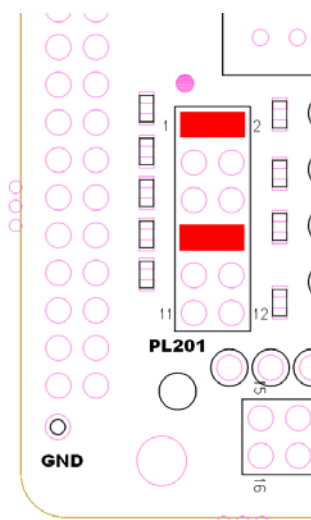

ASC1 to RS-232 (Trace) configuration

17.7.2. GPS to ASC1 (internal host controlling configuration)

This configuration directly connects the host GSM module to the GPS receiver, thus setting the GPS receiver in Controlled Mode.

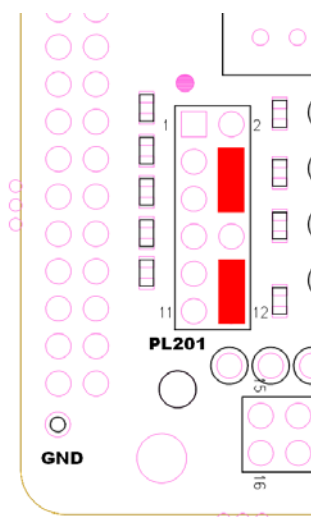

GPS to ASC1 configuration





WARNING:

Other than the ASCII UART, the user must also connect the host module’s GPIOs to the corresponding signals of the GPS receiver (as explained in the next paragraphs).

17.7.3. GPS to RS-232 (external host controlling configuration)

This configuration allows sending the GPS output to the Trace serial connector of the EVK2.

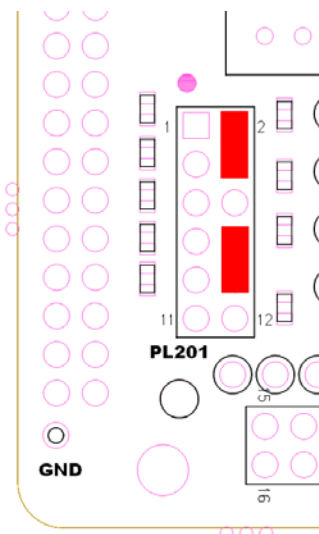

GPS to RS-232 (Trace) configuration

17.7.4. GPS to USB

The NMEA sentences can be redirected to EVK2’s USB port by setting PL201 as explained in the Figure 37, i.e. connecting the NMEA line with the RS-232, and at the same time setting the EVK2 serial line on USB Mode, as shown in Paragraph 7.1 of this document.



17.8. GPIO settings

The interface allows choosing among different options for driving the GPS control signals:
Using the GPIOs of the GSM module

Using an external host

Manually controlling the signals by plugging a jumper.

The last option is not available for every signal and every configuration; please refer to the schematics of the interface for more details.

The choice among the options can be made by PL102, as detailed below.

17.8.1. Internal host controlling configuration

The following settings on PL101 and PL102 allow selecting the internal host configuration.
Two different cases have to be considered:

cs1439b-A

cs1439b and cs1439b-B

Refer to the beginning of this chapter for the correspondence between board part number and mounting options.

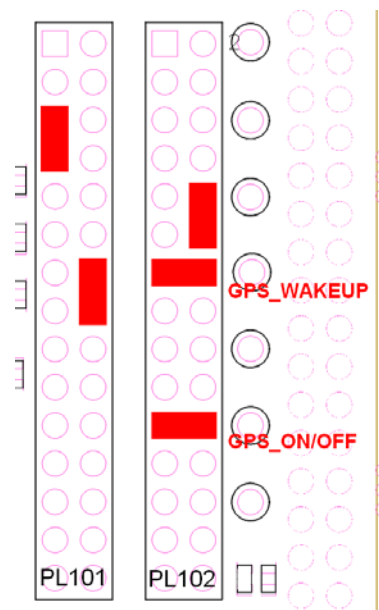

Settings for PL101 and PL102: internal host,cs1439b-A



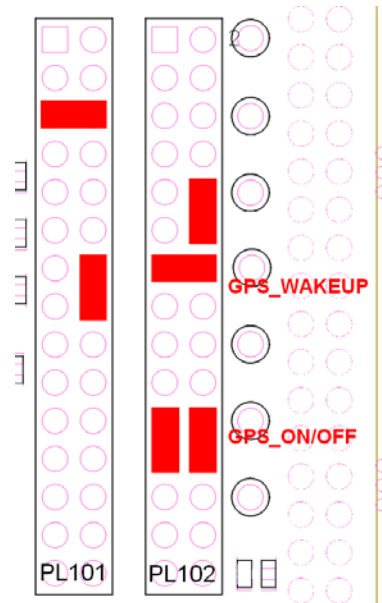

Settings for PL101 and PL102: internal host, **cs1439b** and **cs1439b-B**

Note that jumper settings are detailed in the pictures above.

The signal connected to **pin10** of PL102 is no longer available, and it is recommended to tie it to ground by plugging a jumper between **pin10 & pin12** of PL102.

17.8.2. External host controlling configuration

When an external host is used to drive the GPS module, two different cases have to be considered:

cs1439b-A

cs1439b and **cs1439b-B**

Refer to the beginning of this chapter for the correspondence between board part number and mounting options.

Two jumpers must be plugged, between **pin14 & pin16** of PL101 and **pin10 & pin12** of PL102. Additionally, the host GPIOs must be connected to PL102 as shown in the pictures below.

Note that in this configuration the signal on **pin10** of PL102 is no longer available and it must be connected to ground by plugging a jumper on **pin10 & pin12** of PL102.



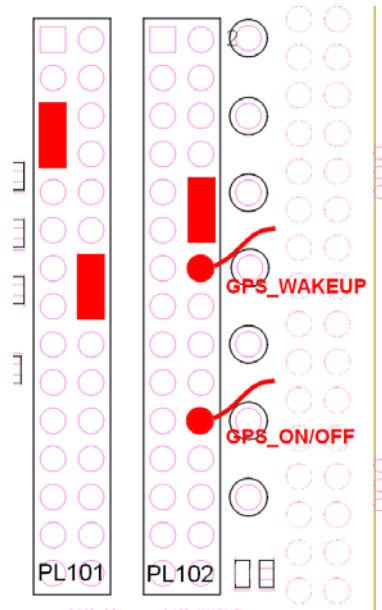

Settings for PL101 and PL102: external host, **cs1439b-A**.

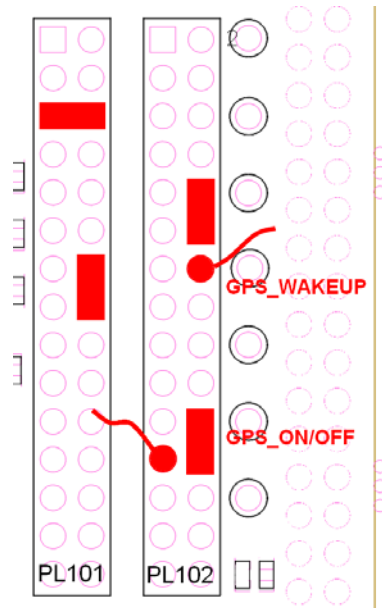

Settings for PL101 and PL102: external host, **cs1439b and cs1439b-B**.



17.9. Antenna connectors

17.9.1. GSM antenna connector

A GSM antenna must be connected to SO105.

17.9.2. GPS antenna connector

A GPS antenna must be connected to SO103.



WARNING:

Don't connect a *GSM* antenna on this connector



18. GE865 – SE867 AGPS Interface

This board allows testing the functionalities and performance of the GE865 and SE867 modules interconnected according to Telit guidelines.

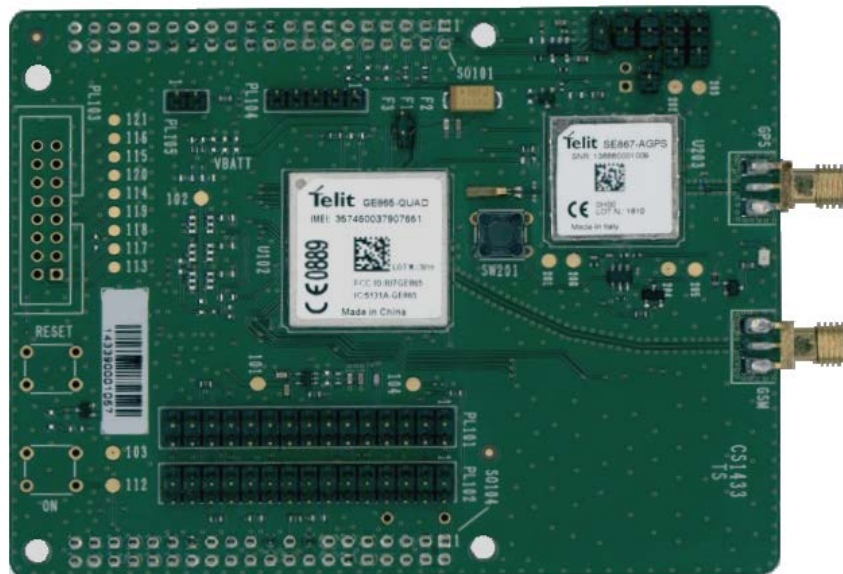

GE865/SE867-AGPS Interface Board

18.1. Stand-alone setup

The interface can be used without the EVK2, in this case the following components have to be soldered on the board:

- the RESET button
- the ON button
- the STATUS led and its load resistor.



18.2. Interface connectors

The following connectors are available:

- 2 male connectors (30 PTH pins each: PL101 and PL102), to connect external devices, user’s applications, Telit extension boards, measurement equipment or other tools
- 2 female connectors (40 PTH pins each one: SO101 and SO104), to connect the interface to the EVK2 mother board circuits (power supply lines, serial in/out lines, audio in/out lines)
- 1 male connector (5 PTH pins: PL104), which makes available in one place all GPIOs related to PCM
- 1 GSM RF connector (SMA Female: SO103)
- 1 GPS RF connector (SMA Female: SO201)
- 1 JTAG connector (PL103, not mounted)
- 2 male connectors (2 PTH pins: PL203, PL205, not mounted), which allow to manually control some functions, therefore freeing the corresponding GPIOs for other uses
- 1 male connector (2 PTH pins: PL204) by means of which the user can manually disable VIN_GPS
- 4 male connectors (2 PTH pins: PL202, PL207; 3 PTH pins: PL201, PL206) to select one particular UART connection configuration.

18.3. Contents of the kit

Please check out the contents of your interface kit. If any of the following items is missing, contact your Telit supplier.

Description	Quantity
GE865/SE867-AGPS INTERFACE	1
JUMPERS	5



18.4. Serial connections

By means of proper jumper connections on PL201, PL202, PL206, and PL207, three different configurations for serial outputs can be selected.

18.4.1. GSM to GPS (GSM controlling configuration)

This configuration is achieved by plugging a female jumper connector on **pin1 & pin2** of both PL201 and PL206. It allows to connect the GE865 UART with SE867-AGPS UART, thereby putting the board in the so-called controlled mode. No connection with the EVK2 RS-232 Trace is present.

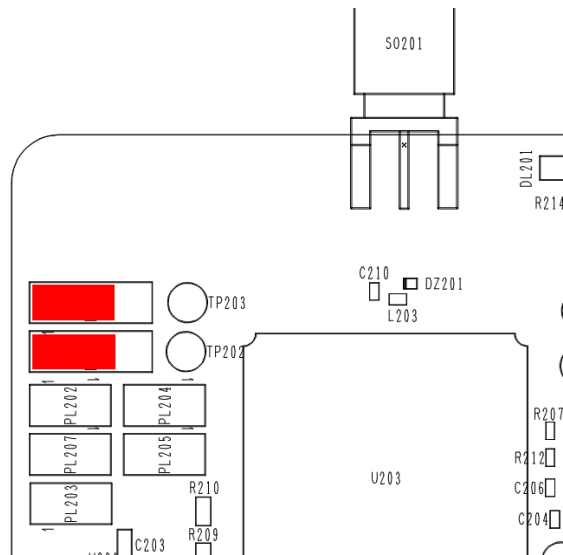

Jumpers in controlled mode configuration.



18.4.2. GSM to Trace

This configuration is realized by plugging a female jumper connector on **pin2 & pin3** of both PL201 and PL206. It allows redirecting the GE865 UART to the EVK2 RS-232 Trace. No connection with the SE867 UART is present.

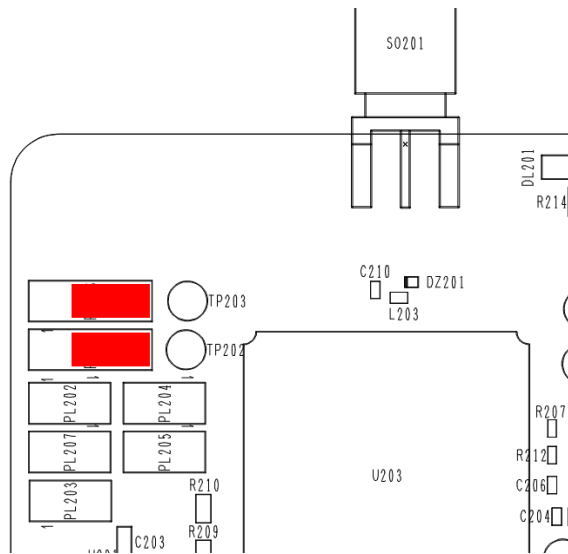

Jumpers in GSM to Trace configuration.



18.4.3. GPS to Trace(external host controlling configuration)

This configuration is achieved by plugging two female jumper connectors on PL202 and PL207. It allows redirecting the SE867 UART to the EVK2 RS-232 Trace. No connection with the GE865 UART is present.

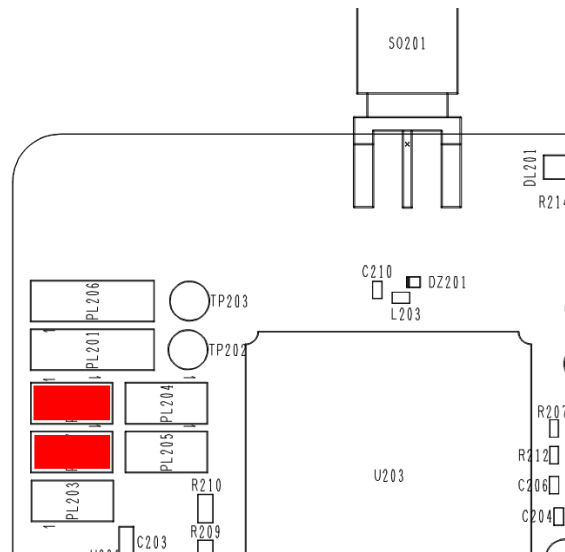

Jumpers in GPS to Trace configuration.

18.5. Antenna connectors

18.5.1. GSM antenna connector

A GSM antenna must be connected to SO103.

18.5.2. GPS antenna connector

A GPS antenna must be connected to SO201.



WARNING:

Don't connect a *GSM* antenna on this connector



19. GE865 – JF2 Interface

This board allows testing the functionalities and performance of the GE865 and JF2 modules interconnected according to Telit guidelines.

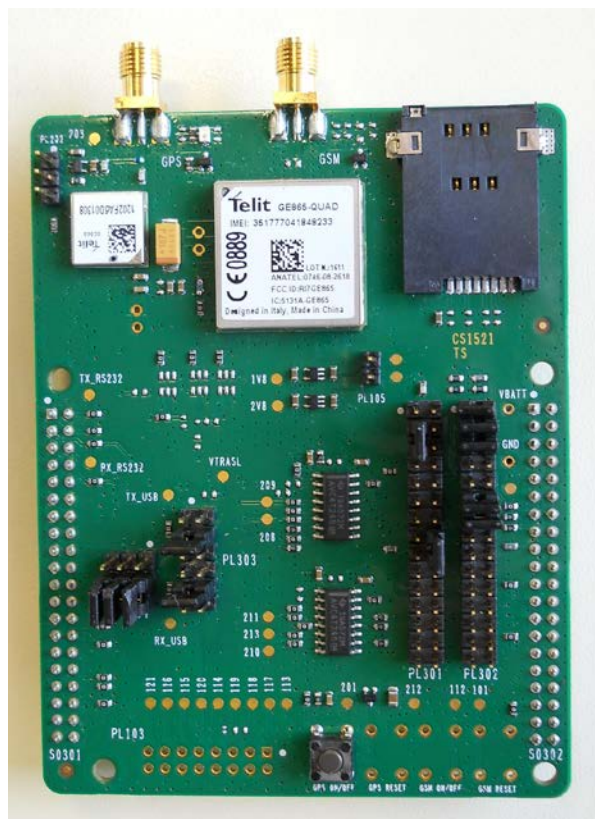

GE865/JF2 Interface Board.

19.1. Stand-alone setup

The interface can be used without EVK2 and in this case the following components have to be soldered to the board:

- RESET button
- GSM ON/OFF button
- GSM STATUS led and its load resistor



19.2. Interface connectors

The following connectors are available:

- 2 male connectors (30 PTH pins each: PL301 and PL302), to connect external devices, user's applications, Telit extension boards, measurement equipment or other tools; PL301 can also be used to select particular configurations between the GSM module's GPIOs and the GPS module
- 2 female connectors (40 PTH pins each one: SO301 and SO302), to connect the interface to the EVK2 mother board circuits (power supply lines, serial in/out lines, audio in/out lines)
- 1 GSM RF connector (SMA Female: SO105)
- 1 GPS RF connector (SMA Female: SO201)
- 1 JTAG connector (PL103, not mounted)
- 1 male connector (3 PTH pins: PL202), to select an enable signal for the external GPS LNA,
- 1 male connector (12 PTH pins: PL303), to select one of the available configurations for the Serial and USB ports.
- 1 male connector (2 PTH pins: PL105), that can be used to insert an ammeter in series with the supply, in order to monitor the module's current consumption,
- 1 male connector (9 PTH pins: PL304), in order to set the data format between USB or SSC0 lines to send to EVK2.

19.3. Contents of the kit

Please check out the contents of your interface kit. If any of the following items is missing, contact your Telit supplier.

Description	Quantity
GE865/JF2 INTERFACE	1
JUMPERS	15

19.4. Power supply

The GE865 module (but not the whole interface) receives its power supply from PL105: this jumper must always be plugged on except when a series measurement instrument is needed.



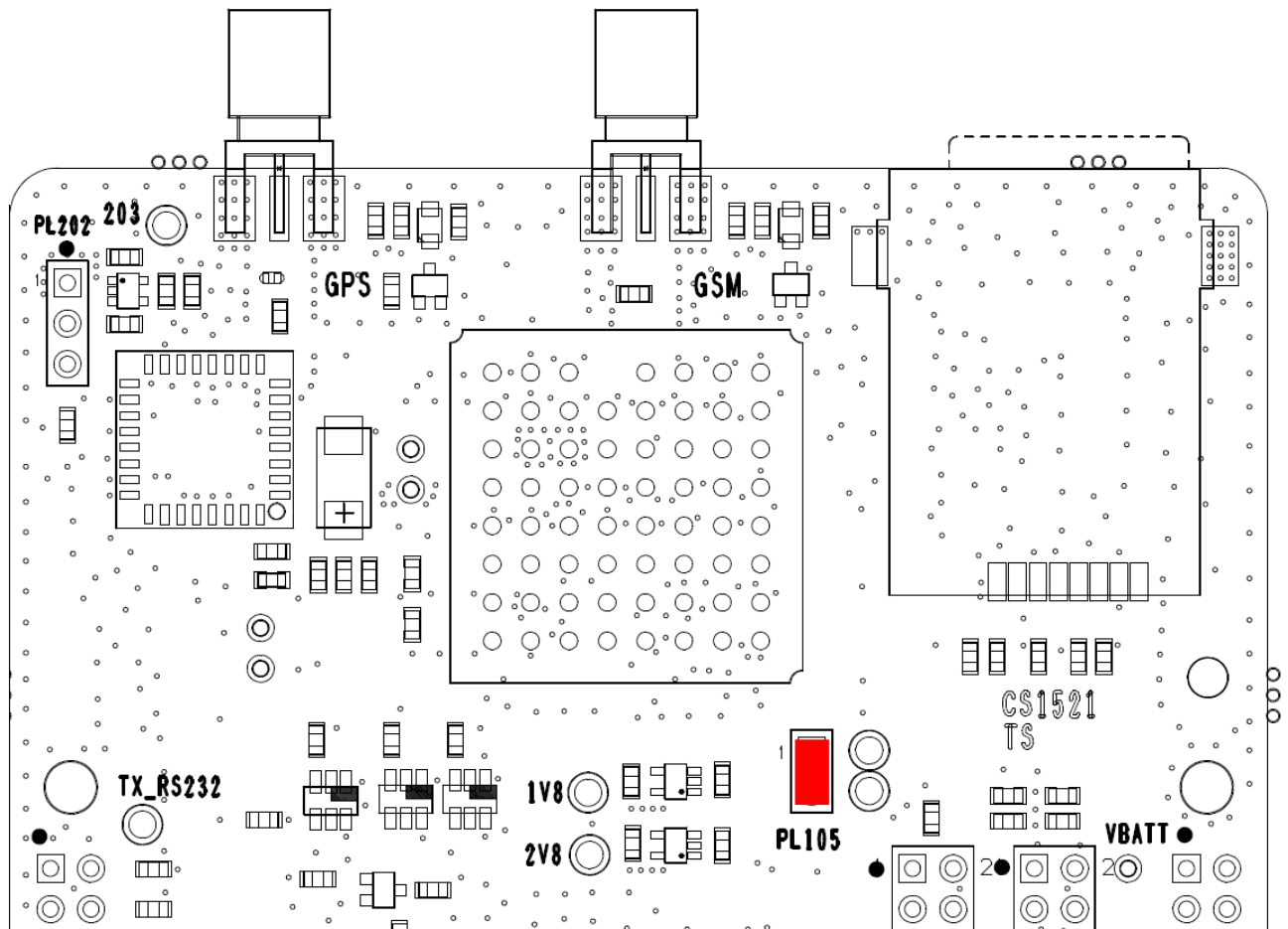

Jumper for VBATT.

19.5. GPS external LNA enable signal

The module contains an internal LNA for the GPS antenna.

The user can though decide to use an external LNA: this option is selected by means of a software command, which puts the internal LNA in a low gain mode and provides an additional signal to enable the external LNA. The interface can provide a bias for the external LNA, and the user can choose whether to enable it by this signal or to leave it always enabled, by means of a jumper on PL202, as shown in the picture below.



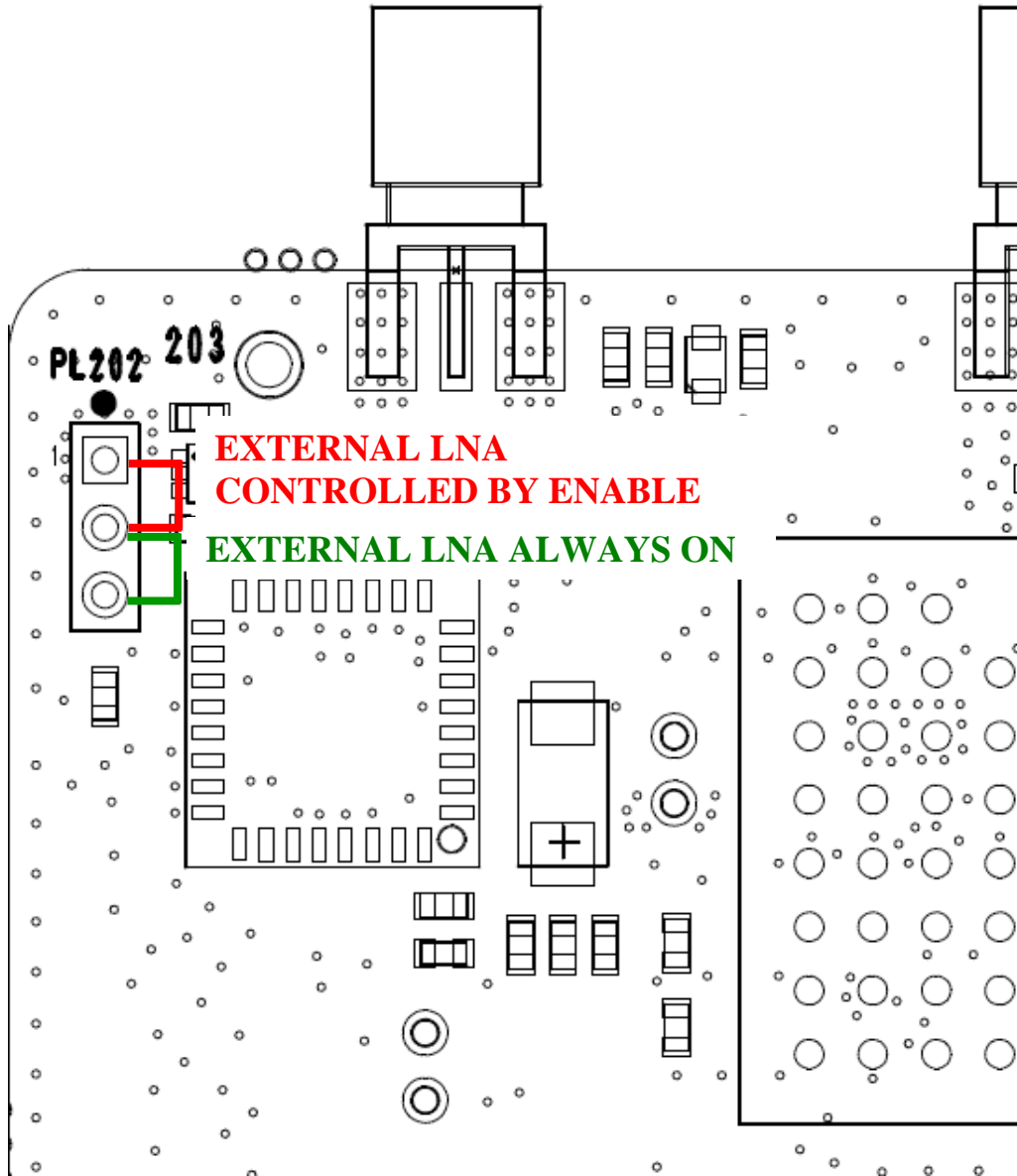

Jumper selection on PL202.

In order to use the External LNA controlled by the GE865 signal the user must insert a jumper in pins 14-16 of PL301.



19.6. Serial port configuration

By means of proper jumper connections on PL303, it is possible to choose different configurations for serial or USB outputs. These configurations are mutually exclusive.

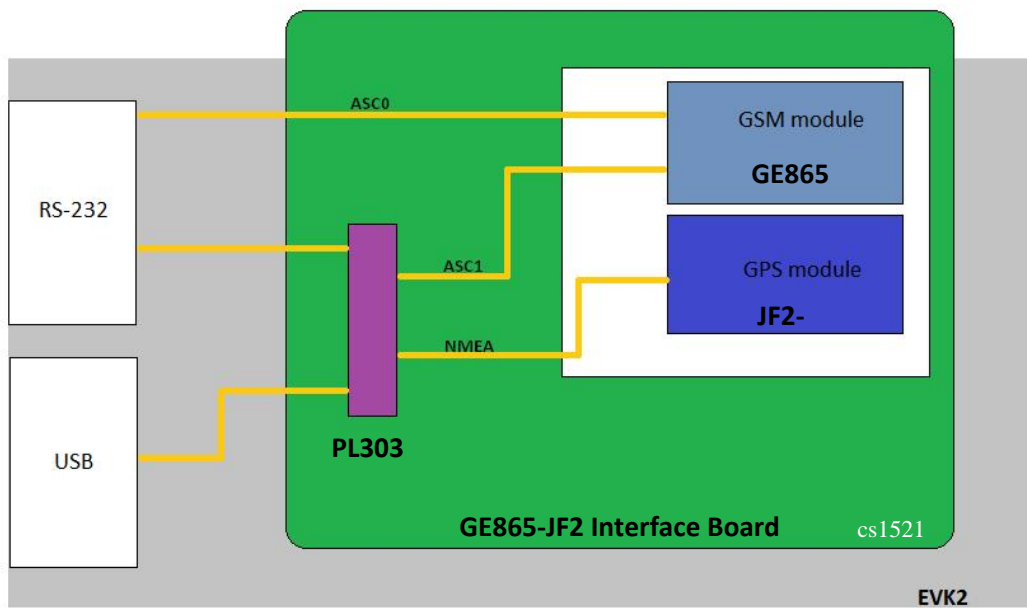

GE865-JF2 Interface Board serial connections



19.7. GSM to Trace

This configuration connects the GSM to the RS232 serial connector of the EVK2.

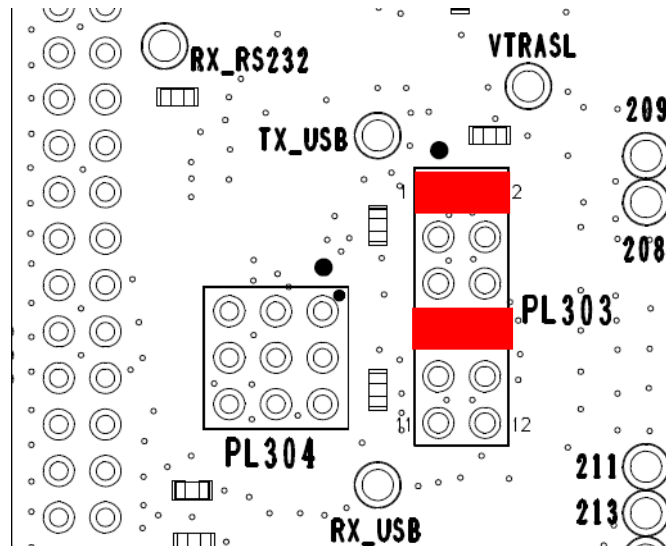

GSM to RS-232 (Trace) configuration

19.8. GPS to Trace

This configuration allows sending the GPS output to the Trace serial connector of EVK2 by means of transceivers.

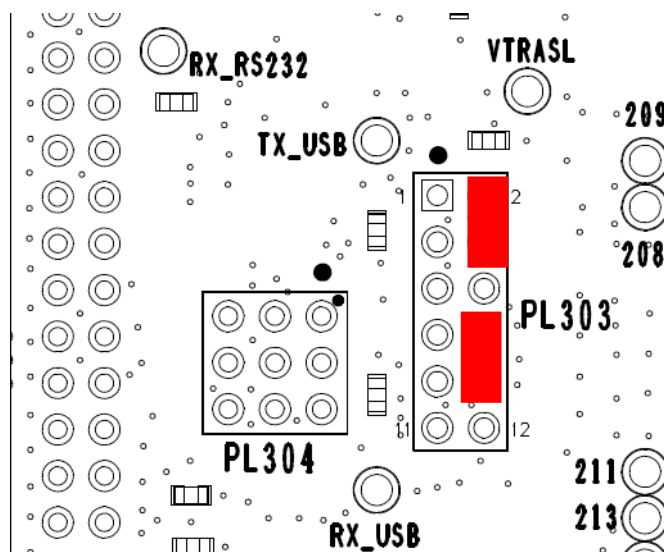

GPS to RS232 (Trace)



19.9. GSM to USB

This configuration connects the GSM to the USB connector of the EVK2.

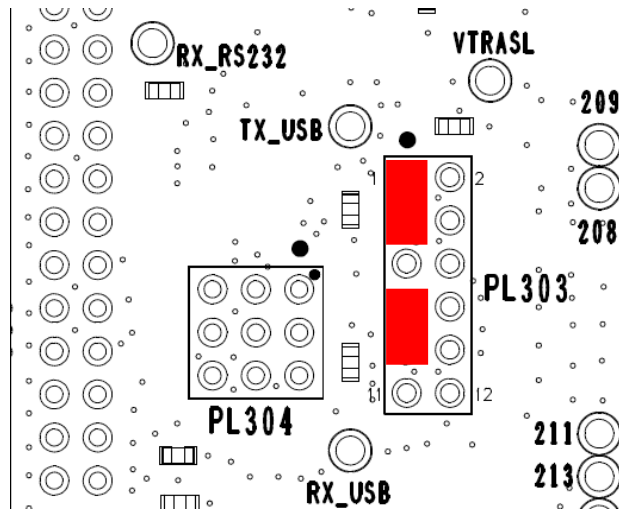

GSM to USB

19.10. GPS to USB

The NMEA sentences can be redirected to the EVK2's USB port by setting the PL303 as explained in the Figure 53, i.e. connecting the NMEA line with the RS-232, and at the same time setting the EVK2 serial line on USB mode, as showed in Paragraph 7.1 of this document.

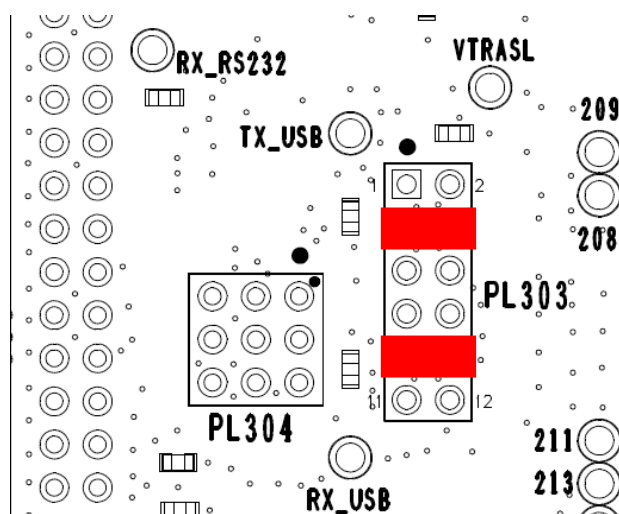

GPS to USB



19.11. GPS to GSM (internal host controlling configuration)

This configuration directly connects the host GSM module to the GPS receiver, thus setting the GPS receiver in Controlled Mode.

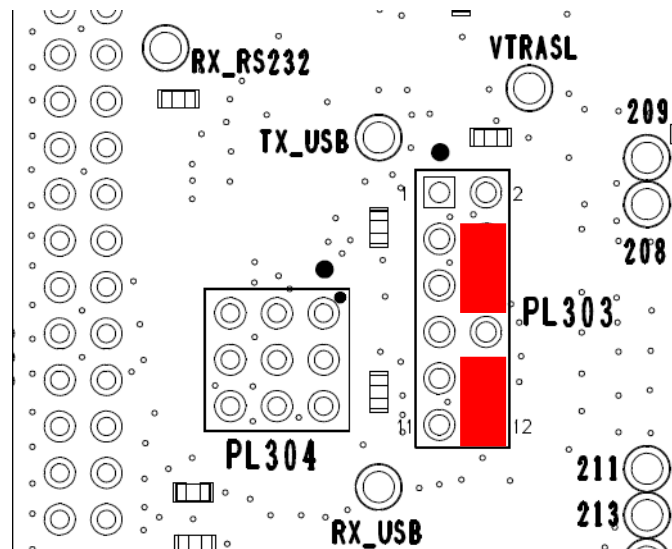

GPS to GSM configuration

19.12. GPIO settings

The interface allows choosing among different options for driving the GPS control signals:

- Using the GPIOs of the GSM module
- Using an external host
- Manually controlling the signals by plugging jumpers.

The last option is not available for every signal and every configuration; please refer to the schematics of the interface for more details.

The choice among the options can be made by PL301 and PL302, as detailed below.



19.12.1. Internal host controlling configuration

The following settings on PL301 and PL302 allow selecting the internal host configuration.

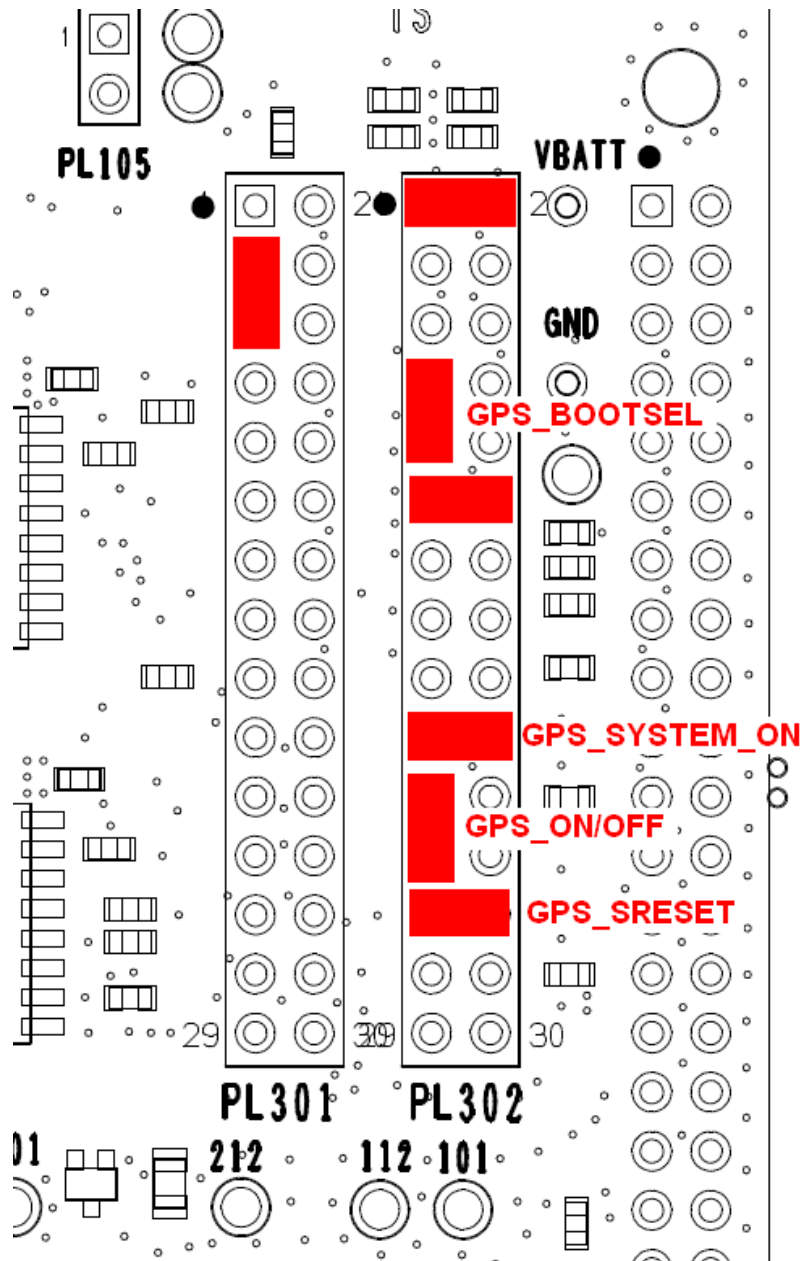

Settings for PL301 and PL302: internal host controlling



19.12.2. External host controlling configuration

The following settings on PL301 and PL302 allow selecting the external host configuration.

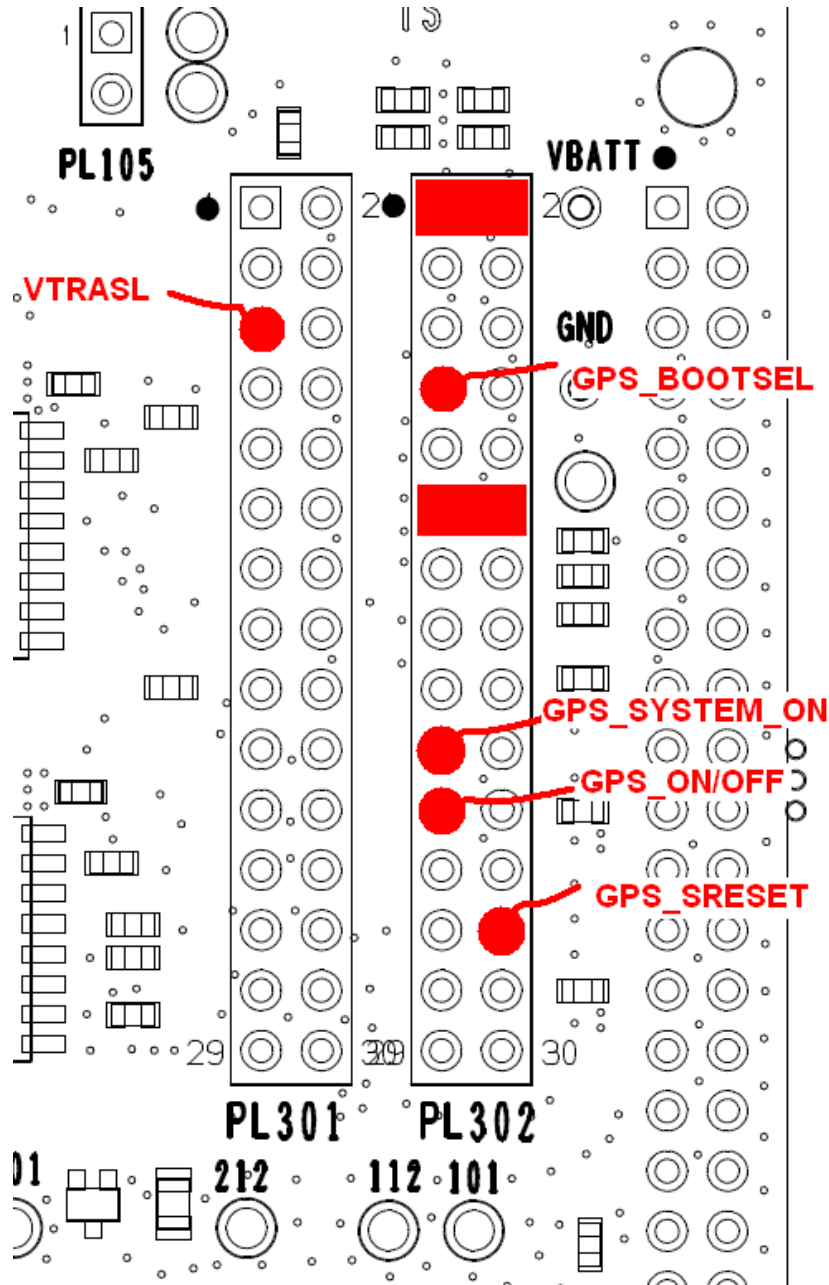

Settings for PL301 and PL302: external host.



19.13. GPS serial interface setting

GPS module has the capability to operate in serial UART mode, SPI mode or I2C mode depending upon how the JF2 GPIO6 and GPIO7 pins are strapped at power up. In the table below is shown the configuration set in PL302 to select the type of serial interface:

MODE	GPS GPIO n.6	GPS GPIO n.7
UART	1-2 pins shorted in PL302	Float
I2C	Float	15-16 pins shorted in PL302
SPI	Float	Float

If you connect JF2 module with GE865 module you must use UART configuration. Using an external host, if you want use I2C configuration, you need to plugging on PL302 two jumpers in positions 3-4 and 5-6 in order to connect pull-ups in SDA and SCL lines.

19.14. MEMS Sensor/EEPROM Interface

The DR I2C port of JF2 is used for connecting to MEMS sensors, such as accelerometer or magnetometer.

	GPS GPIO n.4	GPS GPIO n.0	GPS GPIO n.1
With sensor	Float	3-4 pins shorted in PL302	5-6 pins shorted in PL302
Without sensor	13-14 pins shorted in PL302	Float	Float

19.15. GPS power-on management

JF2 module power on/off can be controlled by an external host signal or it is possible to have the automatic module transition to the full power state by tying the SYSTEM-ON output to the ON-OFF input. The table below shows how to set these two options:

	Power Mode
10-12 and 19-21 pins shorted in PL302	Full power mode
11-12 pins shorted in PL302	ON/OFF controlled by an external host signal



19.16. Antenna connectors

19.16.1. GSM antenna connector

A GSM antenna must be connected to SO105.

19.16.2. GPS antenna connector

A GPS antenna must be connected to SO201.



WARNING:

Don't connect a *GSM* antenna on the GPS antenna connector



20. GL865 – SL869/JN3 Interface

This board allows testing the functionalities and performance of the GL865-V3 and SL869/JN3 modules interconnected according to Telit guidelines.



GL865 – SL869/JN3 Interface Board.



20.1. Stand-alone setup

The interface can be used without EVK2 and in this case the following components have to be soldered to the board:

- GSM RESET button
- GSM ON/OFF button
- GPS STATUS led and its load resistor
- GSM STATUS led and its load resistor (both NO MOUNT)

20.2. Interface connectors

The following connectors are available:

- 2 male connectors (30 PTH pins each: PL300 and PL301), to connect external devices, user's applications, Telit extension boards, measurement equipment or other tools
- 2 female connectors (40 PTH pins each one: SO300 and SO301), to connect the interface to the EVK2 mother board circuits (power supply lines, serial in/out lines, audio in/out lines)
- 1 GSM RF connector (SMA Female: SO101)
- 1 GPS RF connector (SMA Female: SO201)
- 1 JTAG connector (PL100, not mounted)
- 1 male connector (3 PTH pins: PL200), to select an enable signal for the external GPS LNA,
- 1 male connector (12 PTH pins: PL302), to select one of the available configurations for the Serial and USB ports.
- 2 male connector (2 PTH pins: PL101, PL201), that can be used to insert an ammeter in series with the supply, in order to monitor respectively the current consumption of GL865 and SL869/JN3 modules.

20.3. Contents of the kit

Please check out the contents of your interface kit. If any of the following items is missing, contact your Telit supplier.

Description	Quantity
GL865 - SL869/JN3 INTERFACE	1
JUMPERS	10



20.1. Power supply

The GL865 module (but not the whole interface) receives its power supply from PL101: this jumper must always be plugged on except when a series measurement instrument is needed. The SL869/JN3 module receives its power supply from PL201: this jumper must always be plugged on except when a series measurement instrument is needed.

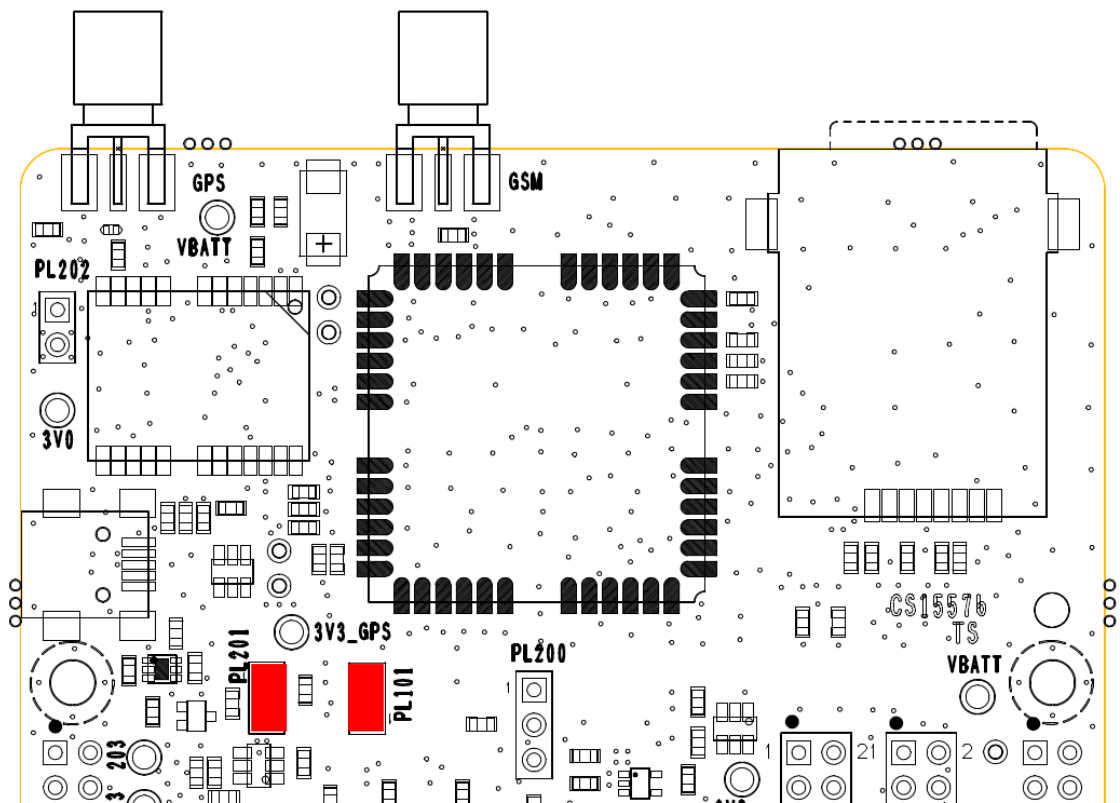

Jumper for VBATT.



20.2. GPS external LNA enable signal

The module contains an internal LNA for the GPS antenna. The user can though decide to use an external LNA: this option is selected by means of a software command, which puts the internal LNA in a low gain mode and provides an additional signal to enable the external LNA. The interface can provide a bias for the external LNA by means of a jumper on PL202, and the user can choose whether to enable it by this signal or to leave it always enabled, by means of a jumper on PL200, as shown in the picture below.

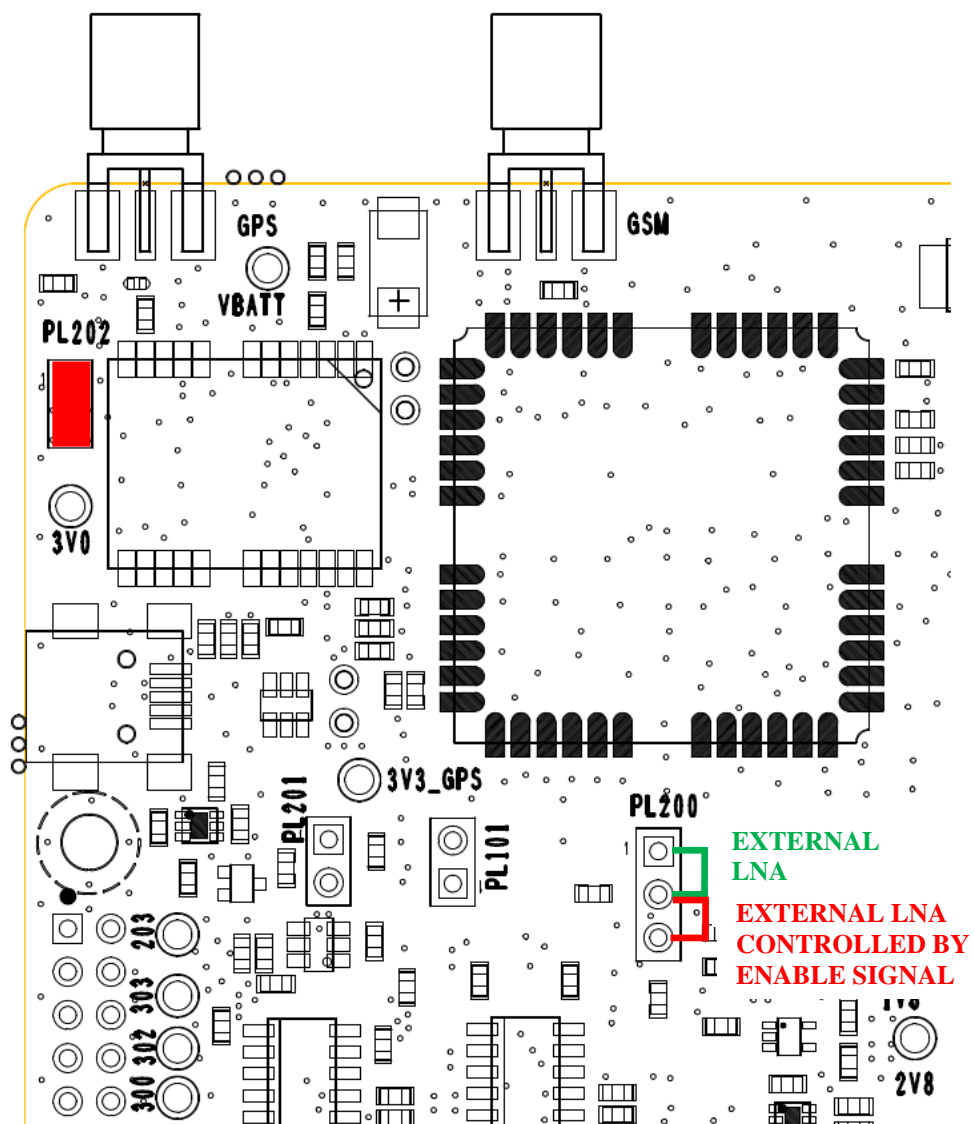

Jumper selection on PL200, PL202 for antenna bias.



20.3. Serial port configuration

By means of proper jumper connections on PL302, it is possible to choose different configurations for serial or USB outputs. These configurations are mutually exclusive.

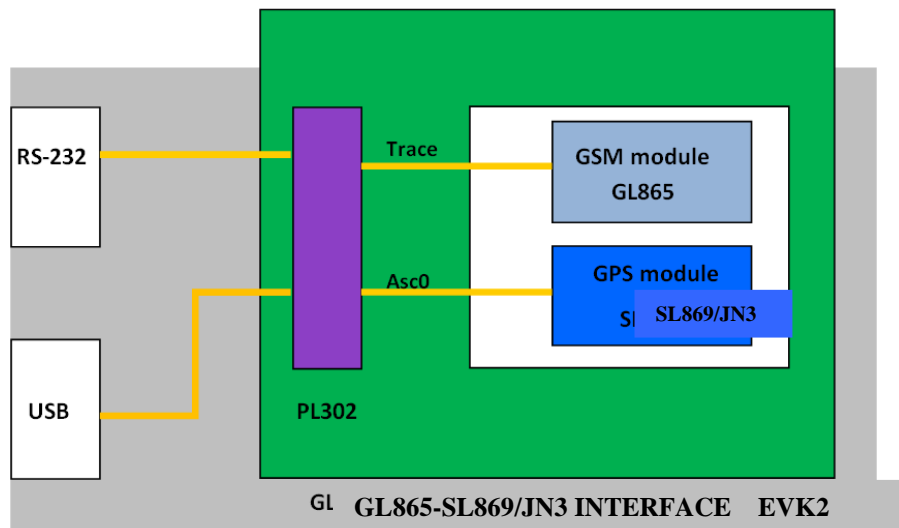

GL865 - SL869/JN3 Interface Board serial connections



20.4. GSM to Trace

This configuration connects the GSM to the RS232 serial connector of the EVK2.

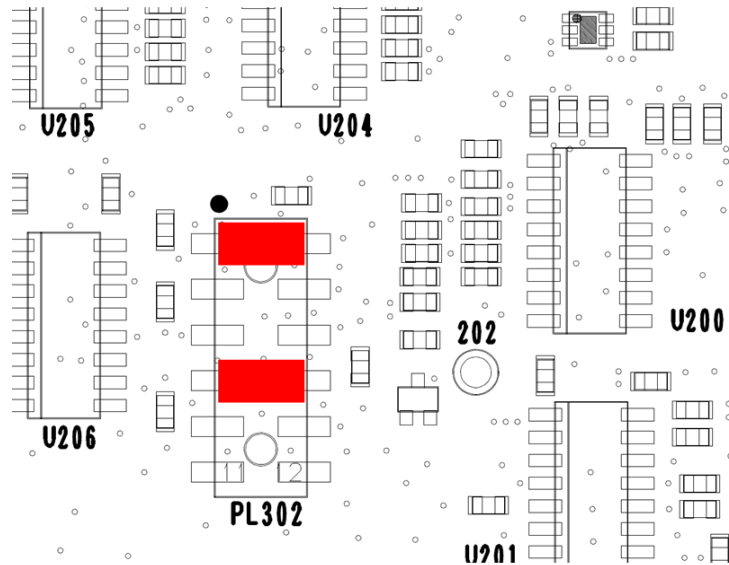

GSM to RS-232 (Trace) configuration

20.5. GPS to Trace

This configuration allows sending the GPS output to the Trace serial connector of EVK2 by means of transceivers

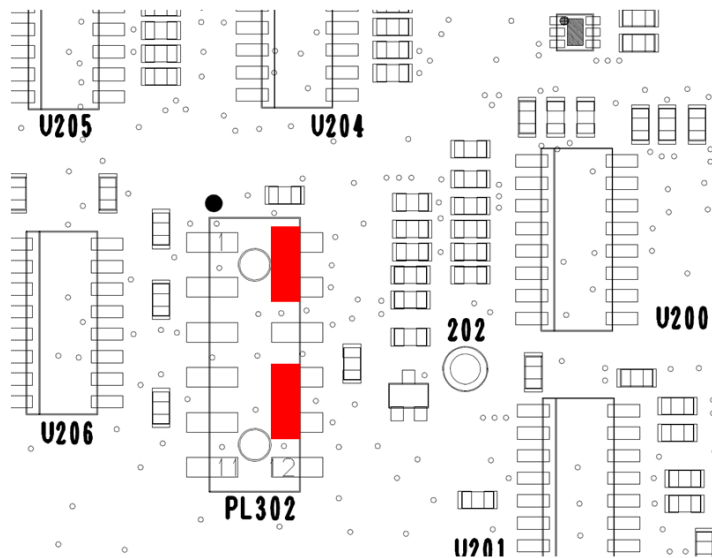

GPS to RS-232 (Trace) configuration



20.6. GSM to USB

This configuration connects the GSM to the USB connector of the EVK2.

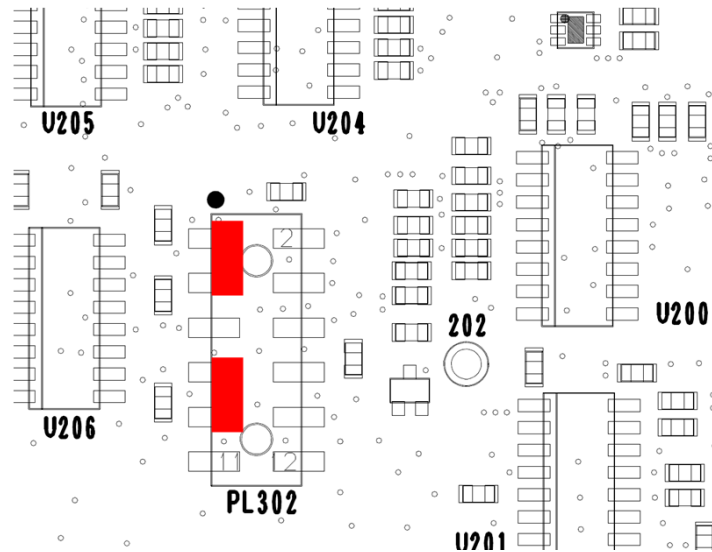

GSM to USB configuration

20.7. GPS to USB

This configuration connects the GPS to the USB connector of the EVK2.

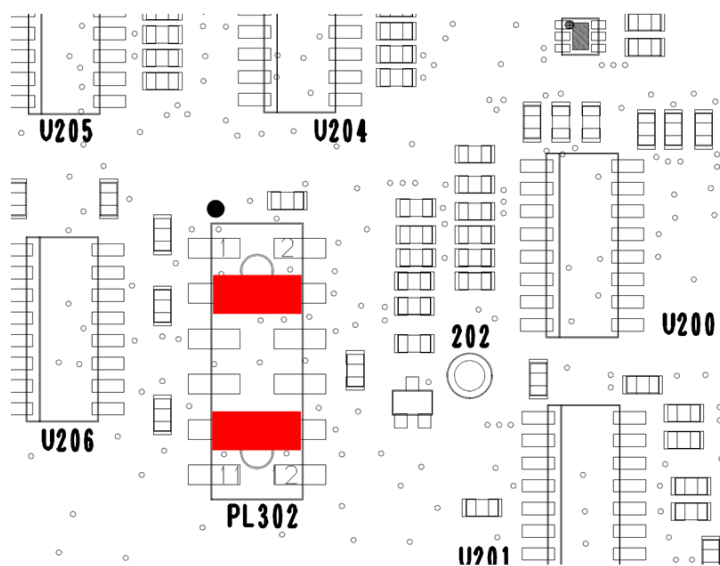

GPS to USB configuration



20.8. GPS to GSM (internal host controlling configuration)

This configuration directly connects the host GSM module to the GPS receiver, thus setting the GPS receiver in Controlled Mode.

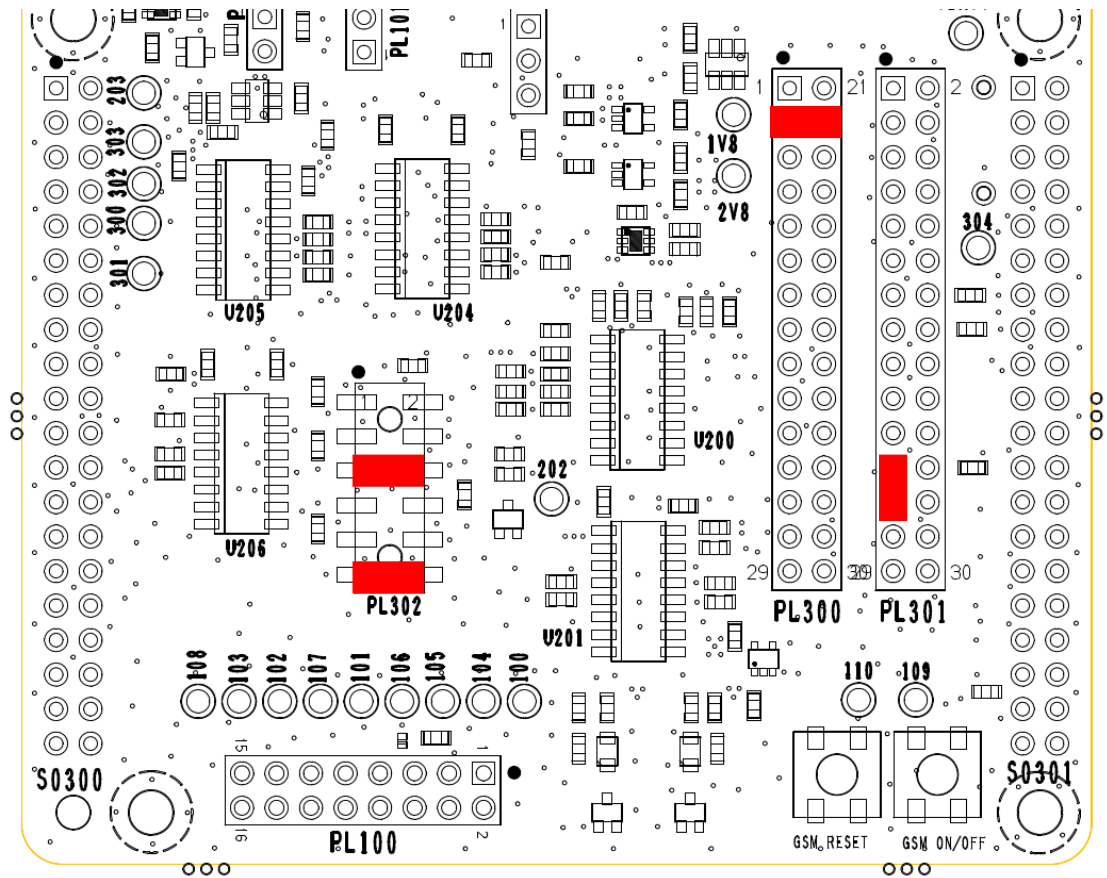

GPS to GSM configuration



20.9. GPIO settings

The interface allows choosing among different options for driving the GPS control signals:

- Using the GPIOs of the GSM module
- Using an external host
- Manually controlling the signals by plugging jumpers.

The last option is not available for every signal and every configuration; please refer to the schematics of the interface for more details.

The choice among the options can be made by PL300, PL301 and as detailed below.

20.9.1. Internal host controlling configuration

The following settings on PL300 and PL301 allow selecting the internal host configuration.

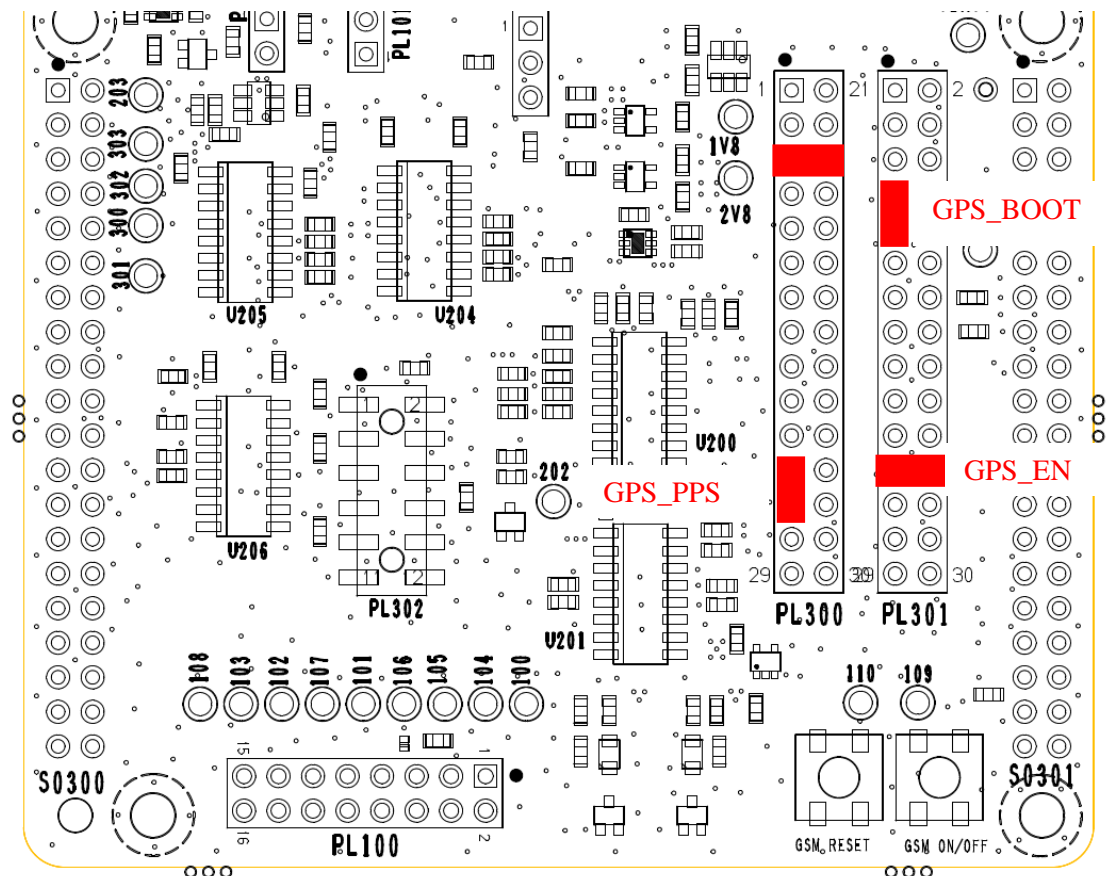

Settings for PL300 and PL301: internal host controlling



20.9.2. External host controlling configuration

The following settings on PL300 and PL301 allow selecting the external host configuration.

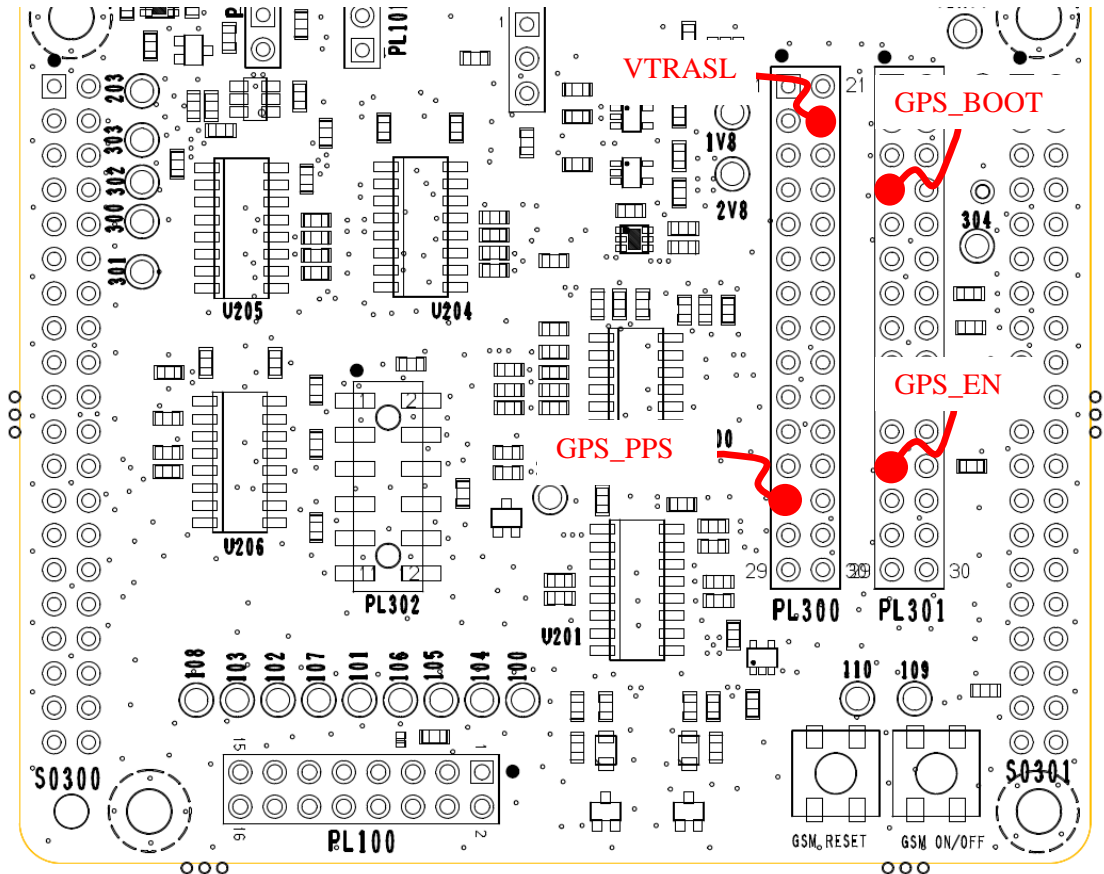

Settings for PL300 and PL301: external host.



20.10. Antenna connectors

20.10.1. GSM antenna connector

A GSM antenna must be connected to SO101.

20.10.2. GPS antenna connector

A GPS antenna must be connected to SO201



21. GC864 Interface

This board allows easily interfacing the module with the EVK2 and testing its functionalities; any version of GC864 can be inserted.

No settings are needed.

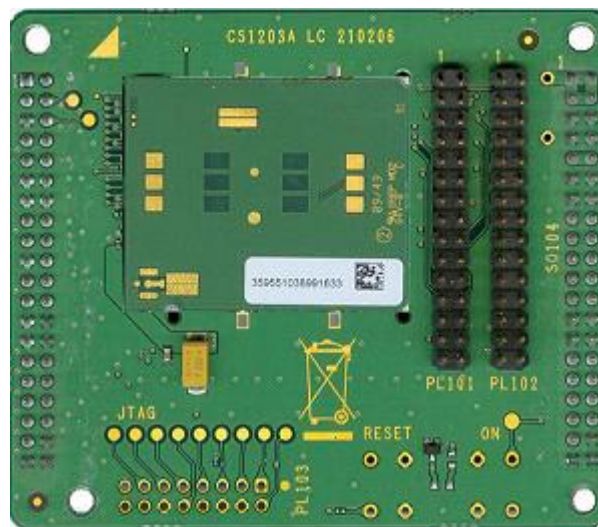

GC864 Interface Board

21.1. Stand-alone setup

If you need to use the interface out of EVK2 (*Stand-alone* setup) you have to mount also:

- the SIMCARD Holder;
- the RESET Button
- the ON Button;
- the STATUS LED and its load resistance.



21.2. Interface connectors

The following connectors are available:

2 male connectors (30 PTH pins each one: PL102, PL103), by which it is possible to connect external devices, user's application, Telit extension boards, measurements equipment or other tools

2 female connectors (40 PTH pins each one: SO101, SO102), to connect the interface to the EVK2 mother board circuits (power supply lines, serial in/out lines, audio in/out lines).

21.3. Content of the kit

Please check out the contents of your interface kit; if any of the items is missing, please contact your supplier.

Description	Quantity
GC864 INTERFACE	1
ASSEMBLED CABLE L-200 COAX 0.8 TERMINALS GSC & SMA F PANNEL	1



22. GC864-C2 family Interface

This board allows easily interfacing the module with the EVK2 and testing its functionalities; any version of GC864-C2 can be inserted.
No settings are needed.



GC864-C2 Interface Board

22.1. Stand-alone setup

If you need to use the interface out of EVK2 (*Stand-alone* setup) you have to mount the following missing components:

- the SIMCARD Holder ;
- the ON Button ;
- the STATUS LED and its load resistance.



22.2. Interface connectors

The following connectors are available:

2 male connectors (30 PTH pins each one: *PL101*, *PL102*), by which it is possible to connect external devices, user's application, Telit extension boards, measurements equipment or other tools;

2 female connectors (40 PTH pins each one: *SO101*, *SO104*), to connect the interface to the EVK2 mother board circuits (power supply lines, serial in/out lines, audio in/out lines);

22.3. Content of the kit

Please check out the contents of your interface kit; if any of the items is missing, please contact your supplier.

Description	Quantity
GC864-C2 INTERFACE	1
ASSEMBLED CABLE L-250 RG174 TERMINALS SMA F & MMCX 90 M	1



23. GE865 Interface

This board allows easily interfacing the GE865 modules with the EVK2 and testing their functionalities;

No settings are needed.



GE864 Interface Board

23.1. Stand-alone setup

If you need to use the interface out of EVK2 (*Stand-alone* setup) you have to mount the following missing components:

- the RESET Button
- the ON Button;
- the STATUS LED and its load resistance.



23.2. Interface connectors

The following connectors are available:

2 male connectors (30 PTH pins each one: PL102, PL103), by which it is possible to connect external devices, user’s application, Telit extension boards, measurements equipment or other tools;

2 female connectors (40 PTH pins each one: SO101, SO102), to connect the interface to the EVK2 mother board circuits (power supply lines, serial in/out lines, audio in/out lines);

23.3. Content of the kit

Please check out the contents of your interface kit; if any of the items is missing, please contact your supplier.

Description	Quantity
GE865 INTERFACE	1



24. GL865 Interface

This board allows easily interfacing the GL865 modules with the EVK2 and testing their functionalities;
No settings are needed.



GL865 Interface Board

24.1. Stand-alone setup

If you need to use the interface out of EVK2 (*Stand-alone* setup) you have to mount the following missing components:

- the RESET Button
- the ON Button;
- the STATUS LED and its load resistance.



24.2. Interface connectors

The following connectors are available:

2 male connectors (30 PTH pins each one: *PL102*, *PL103*), by which it is possible to connect external devices, user’s application, Telit extension boards, measurements equipment or other tools;

2 female connectors (40 PTH pins each one: *SO101*, *SO102*), to connect the interface to the EVK2 mother board circuits (power supply lines, serial in/out lines, audio in/out lines);

24.3. Content of the kit

Please check out the contents of your interface kit; if any of the items is missing, please contact your supplier.

Description	Quantity
GL865 INTERFACE	1



25. UC864 family Interface

This board allows easily interfacing the UC864/CC864 modules with the EVK2 and testing their functionalities;

No settings are needed.

For more information please refer to 1v0300771 (UC864/CC864 Interface Board User Guide)



UC864 Interface Board

25.1. Stand-alone setup

If you need to use the interface out of EVK2 (*Stand-alone* setup) you have to mount the following missing components:

- the RESET Button
- the ON Button;



25.2. Interface connectors

The following connectors are available:

male connectors (30 PTH pins each one: PL101, PL102), by which it is possible to connect external devices, user's application, Telit extension boards, measurements equipment or other tools;

female connectors (40 PTH pins each one: CON102, CON103), to connect the interface to the EVK2 mother board circuits (power supply lines, serial in/out lines, audio in/out lines);
2 USB connectors (selectable by Jumper Setting)

For additional details on the connections and the possible Jumper settings please refer to the Interface board User guide (1vv0300771)

25.3. Content of the kit

Please check out the contents of your interface kit; if any of the items is missing, please contact your supplier.

Description	Quantity
UC864/CC864 INTERFACE	1



26. HE910 family Interface

This board allows easily interfacing the HE910 modules with the EVK2 and testing their functionalities;

No settings are needed.



HE910 Interface Board



26.1. Stand-alone setup

The Jumper setting and the assembled components are ready permitting the standalone use.

26.2. Interface connectors

The following connectors are available:

2 female connectors (40 PTH pins each one: SO101, SO104), to connect the interface to the EVK2 mother board circuits (power supply lines, serial in/out lines, audio in/out lines);

1 USB connector (SO202) related to the HE910 USB 2.0 port.

3 RF connectors for GSM/UMTS Antenna (SO103), Receiver Diversity Antenna (SO105) and GPS Antenna (SO102)

1 SIM Holder (SO204)

A group of Male connectors (PL301, PL302, PL303, PL304, PL102, PL203, PL204) that provide the additional signals (i.e. GPIOs) and could select the functions by Jumper setting (see the related document section/schematic for this).

The following picture is showing the connector's positions and the default settings for the Jumpers.

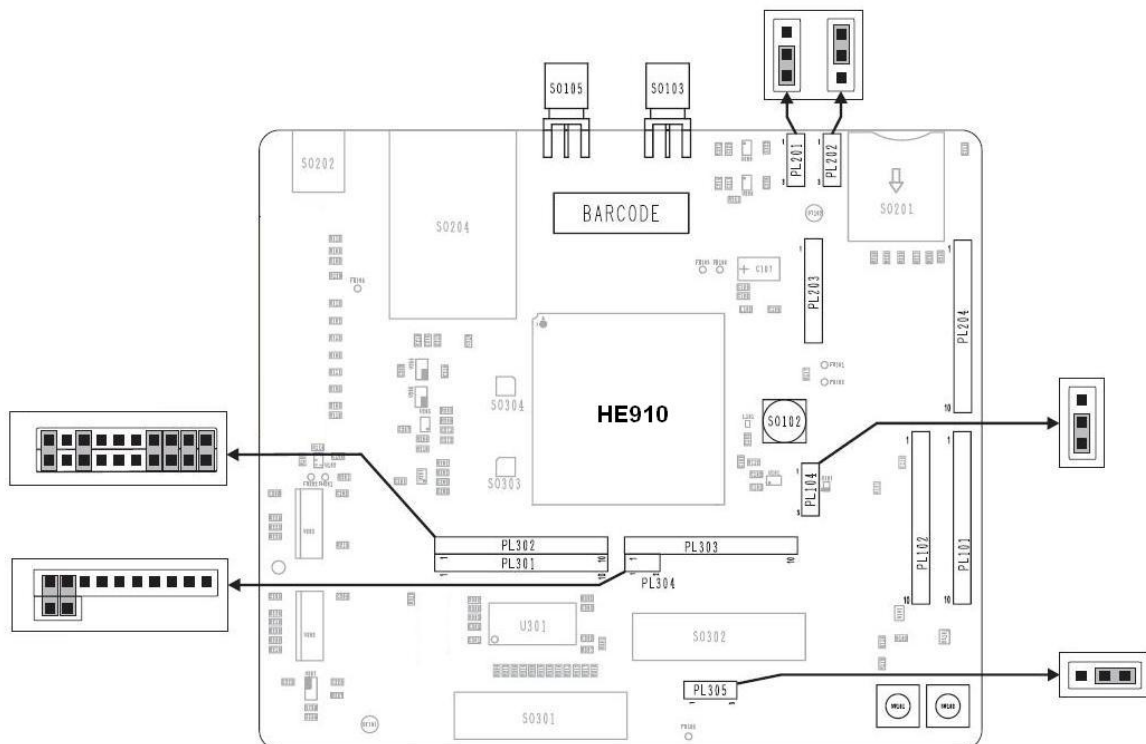

26.3. Antenna connectors

26.3.1. GSM/UMTS Antenna connector

A GSM/UMTS compatible antenna (Refer to the product’s HW user guide) antenna must be connected to SO103.

26.3.2. Receiver Diversity Antenna connector

A GSM/UMTS compatible antenna (Refer to the product’s HW user guide) antenna could be connected to SO105.

26.3.3. GPS antenna connector

A GPS antenna could be connected to SO102. Please refer to the product’s HW user guide for the proper type.

The GPS Antenna (if an active type) could be supplied with a dedicated LDO (3V DC) that could be set in the following way using the Jumpers on PL104.

LDO Enabled by the HE910 Module.

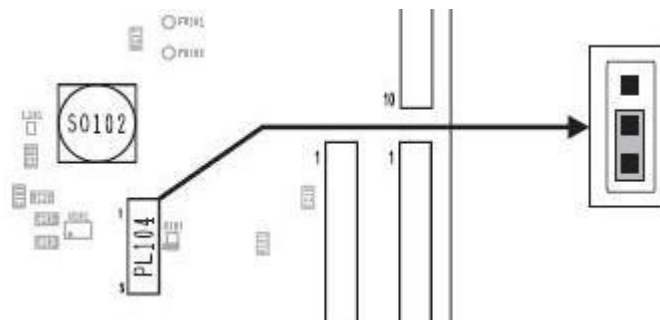

LDO Always Enabled

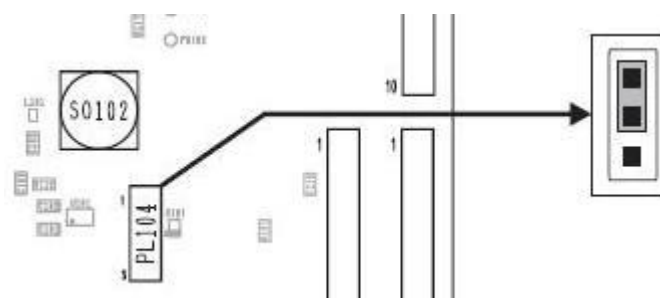

WARNING:

Don't connect a *GSM/UMTS* antenna on this connector



26.4. Expansion Connectors

26.4.1. PL301/PL302

The connectors are carrying the following signals:

PL301		
Pin#	Pin Name	Description
1	STAT_LED	Status Led
2	NC	
3	RESERVED	
4	NC	
5	NC	
6	NC	
7	C125/RING	
8	C107/DSR	
9	C109/DCD	
10	RESERVED	

PL302		
Pin#	Pin Name	Description
1	GPIO_01	Default function is Status Led
2	GPIO_02	
3	GPIO_03	
4	GPIO_04	
5	GPIO_06	
6	GPIO_07	
7	C125/RING	Jumper to EVK2
8	C107/DSR	Jumper to EVK2
9	C109/DCD	Jumper to EVK2
10	RESERVED	Jumper to EVK2



26.4.2. PL303/PL304/PL305

The connectors are carrying the following signals:

PL303		
Pin#	Pin Name	Description
1	TX_AUX	Auxiliary serial port (TX)
2	RX_AUX	Auxiliary serial port (RX)
3	SPI_CLK	SPI
4	SPI_MRDY	SPI
5	SPI_SRDY	SPI
6	GPIO_08	
7	GPIO_09	
8	GPIO_10	
9	RESERVED	
10	NC	

PL304		
Pin#	Pin Name	Description
1	TX_AUX	Jumper to EVK2
2	RX_AUX	Jumper to EVK2

PL305		
Pin#	Pin Name	Description
1	RESERVED	-
2	VDD_IO	Input pin for the bus supply
3	VIO_1V8	VIO supply at 1.8V



26.4.3. PL102

The connector is providing the following signals:

PL102		
Pin#	Pin Name	Description
1	VAUX/PWRMON	Auxiliary supply / Power On Indicator
2	VRTC	RTC Backup
3	RESERVED	
4	RESERVED	
5	RESERVED	
6	GPIO_05	GPIO
7	RESERVED	
8	RESERVED	
9	RESERVED	
10	GND	

26.4.4. ON_OFF & UNCONDITIONAL SHUTDOWN BUTTONS

The 2 Buttons present on the Interface should be used to control the Power ON and UNCONDITIONAL SHUTDOWN lines of the module.

The 2 Buttons on the EVK2 could not be used with the HE910 Interface.

26.5. Content of the kit

Please check out the contents of your interface kit; if any of the items is missing, please contact your supplier.

Description	Quantity
HE910 INTERFACE	1
MINI USB CABLE	1



27. UE910 family Interface

This board allows easily interfacing the UE910 modules with the EVK2 and testing their functionalities;
No settings are needed.

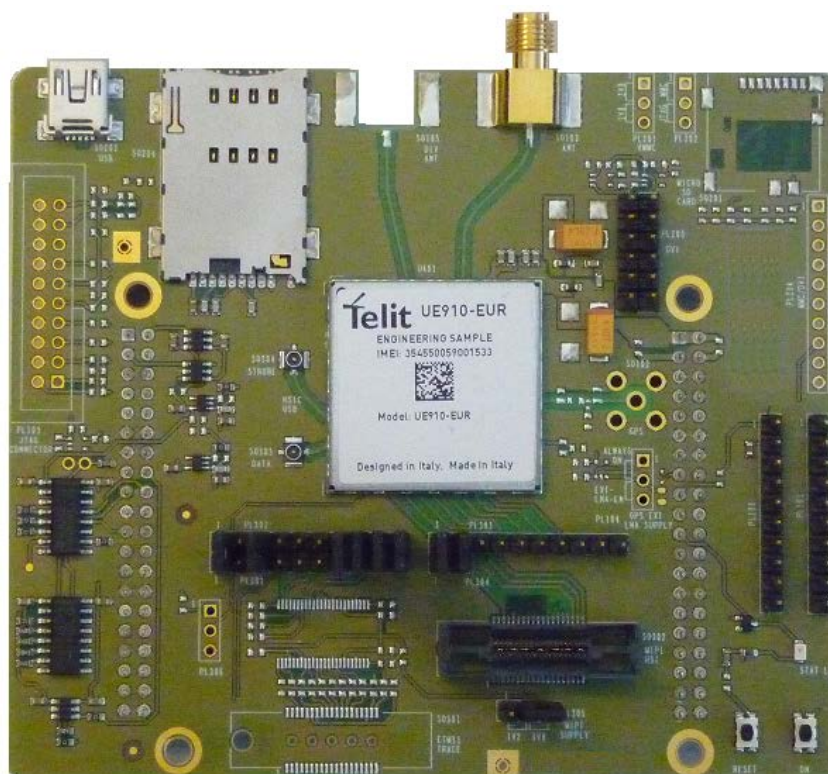

UE910 Interface Board



27.1. Stand-alone setup

The Jumper setting and the assembled components are ready permitting the standalone use.

27.2. Interface connectors

The following connectors are available:

2 female connectors (40 PTH pins each one: SO101, SO104), to connect the interface to the EVK2 mother board circuits (power supply lines, serial in/out lines, audio in/out lines);

1 USB connector (SO202) related to the UE910 USB 2.0 port.

1 RF connectors for GSM/UMTS Antenna (SO103)

1 SIM Holder (SO204)

A group of Male connectors (PL301, PL302, PL303, PL304) that provide the additional signals (i.e. GPIOs) and could select the functions by Jumper setting (see the related document section/schematic for this).

The following picture is showing the connector's positions and the default settings for the Jumpers. Antenna connectors

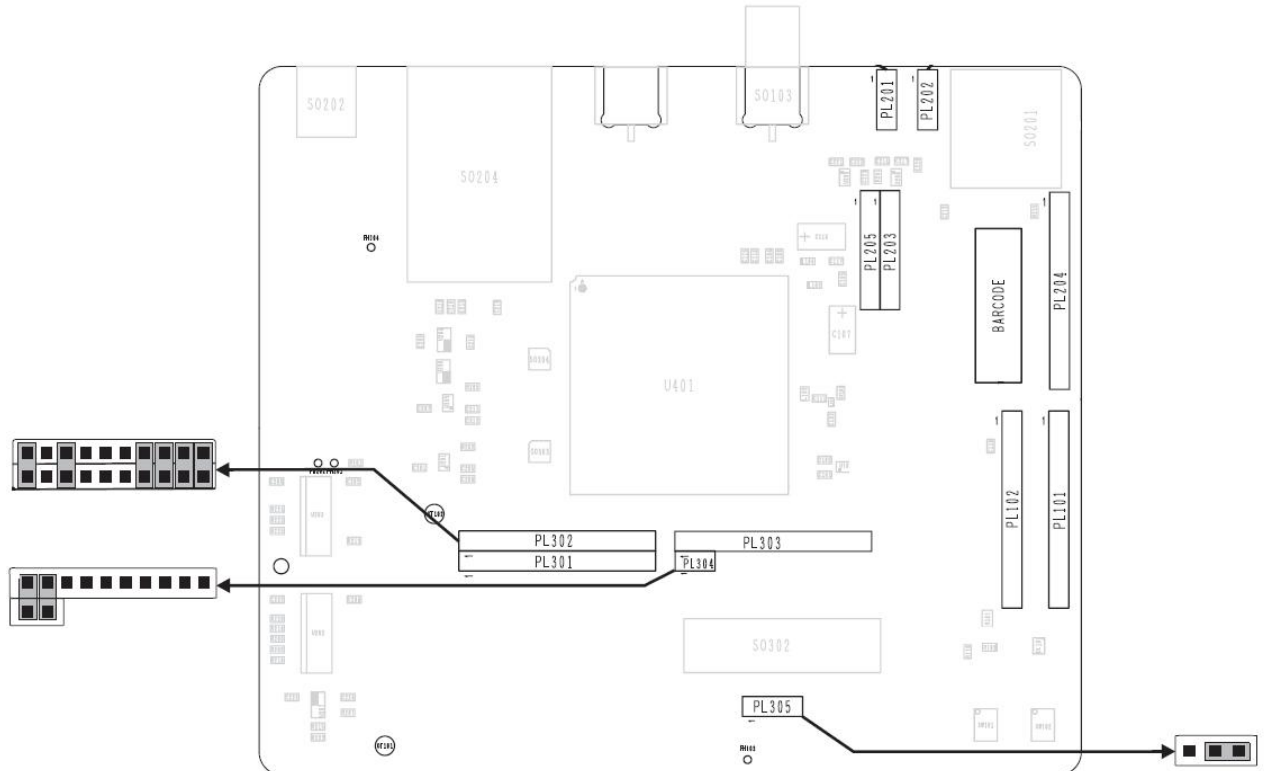

27.2.1. GSM/UMTS Antenna connector

A GSM/UMTS compatible antenna (Refer to the product’s HW user guide) antenna must be connected to SO103.

27.3. Expansion Connectors

27.3.1. PL301/PL302

The connectors are carrying the following signals:

PL301		
Pin#	Pin Name	Description
1	STAT_LED	Status Led
2	NC	
3	RESERVED	
4	NC	
5	NC	
6	NC	
7	C125/RING	
8	C107/DSR	
9	C109/DCD	
10	RESERVED	

PL302		
Pin#	Pin Name	Description
1	GPIO_01	Default function is Status Led
2	GPIO_02	
3	GPIO_03	
4	GPIO_04	
5	GPIO_06	
6	GPIO_07	
7	C125/RING	Jumper to EVK2
8	C107/DSR	Jumper to EVK2
9	C109/DCD	Jumper to EVK2
10	RESERVED	Jumper to EVK2



28. GE910 Interface

This board allows easily interfacing the GE910 module with the EVK2 and testing their functionalities;
No settings are needed.

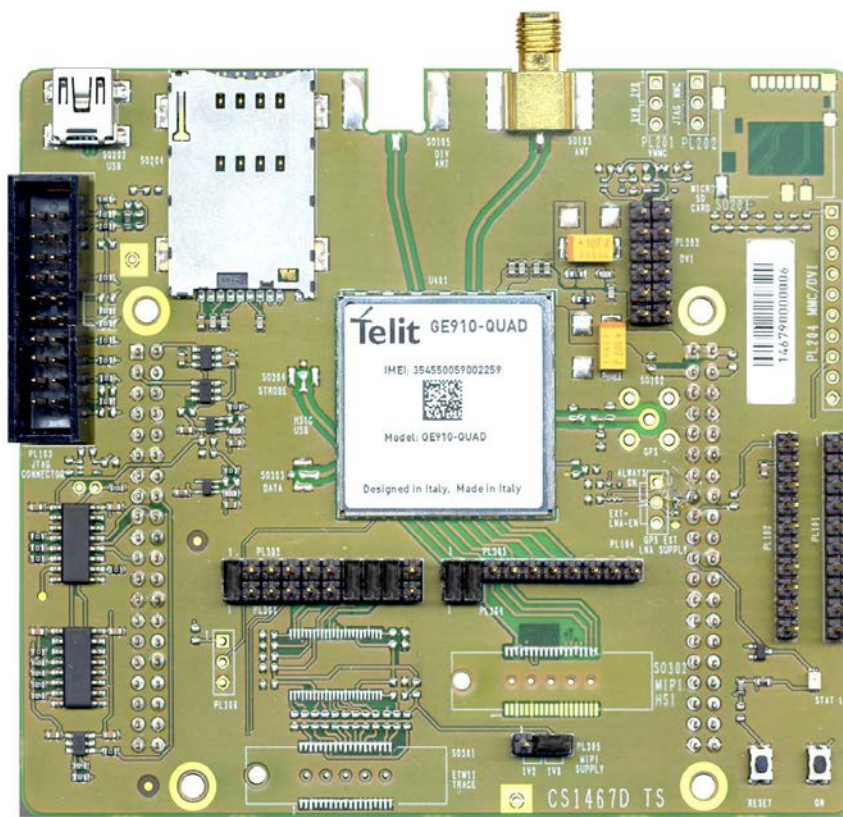

GE910 Interface Board



28.1. Stand-alone setup

The Jumper setting and the assembled components are ready permitting the standalone use.

28.2. Interface connectors

The following connectors are available:

2 female connectors (40 PTH pins each one: SO101, SO104), to connect the interface to the EVK2 mother board circuits (power supply lines, serial in/out lines, audio in/out lines);

1 USB connector (SO202) related to the GE910 USB 2.0 port.

1 RF connectors for GSM/GPRS Antenna (SO103),

1 SIM Holder (SO204)

A group of Male connectors (PL301, PL302, PL303, PL304, PL305, PL102, PL203) that provide the additional signals (i.e. GPIOs) and could select the functions by Jumper setting (see the related document section/schematic for this).

The following picture is showing the connector's positions and the default settings for the Jumpers.

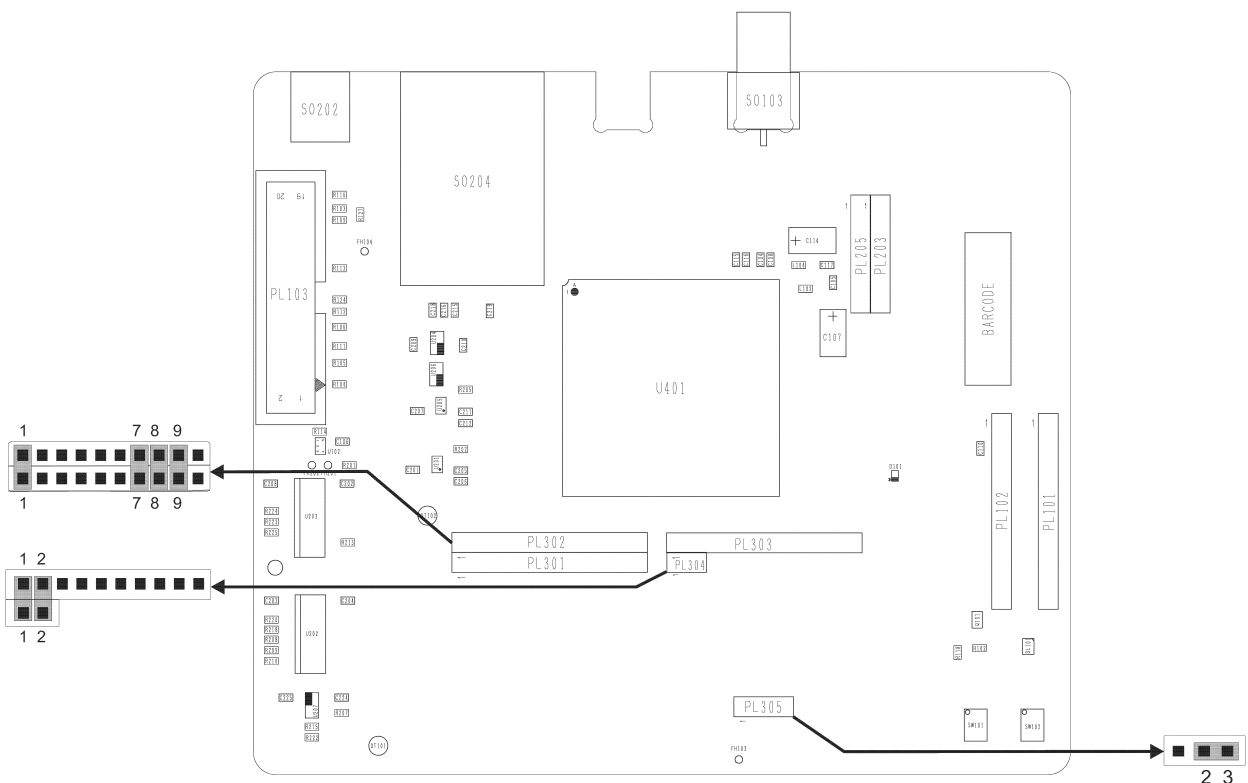

28.3. Antenna connectors

28.3.1. GSM/GPRS Antenna connector

A GSM/GPRS compatible antenna (Refer to the product’s HW user guide) antenna must be connected to SO103.

28.4. Expansion Connectors

28.4.1. PL301/PL302

The connectors are carrying the following signals:

PL301		
Pin#	Pin Name	Description
1	STAT_LED	Status Led
2	NC	
3	RESERVED	
4	NC	
5	NC	
6	NC	
7	C125/RING	
8	C107/DSR	
9	C109/DCD	
10	RESERVED	

PL302		
Pin#	Pin Name	Description
1	GPIO_01	Jumper to EVK2 Default function is Status Led
2	GPIO_02	
3	GPIO_03	
4	GPIO_04	
5	GPIO_06	
6	GPIO_07	
7	C125/RING	Jumper to EVK2
8	C107/DSR	Jumper to EVK2
9	C109/DCD	Jumper to EVK2
10	RESERVED	



28.4.2. PL303/PL304

The connectors are carrying the following signals:

PL303		
Pin#	Pin Name	Description
1	TX_AUX	Auxiliary serial port (TX)
2	RX_AUX	Auxiliary serial port (RX)
3	RESERVED	
4	RESERVED	
5	RESERVED	
6	GPIO_08	
7	GPIO_09	
8	GPIO_10	
9	RESERVED	
10	NC	

PL304		
Pin#	Pin Name	Description
1	TX_AUX	Jumper to EVK2
2	RX_AUX	Jumper to EVK2

28.4.3. PL102

The connector is providing the following signals:

PL102		
Pin#	Pin Name	Description
1	VAUX/PWRMON	Auxiliary supply / Power On Indicator
2	VRTC	RTC Backup
3	RESERVED	
4	RESERVED	
5	RESERVED	
6	GPIO_05	GPIO
7	RESERVED	
8	RESERVED	
9	RESERVED	
10	GND	



28.4.4. ON_OFF & UNCONDITIONAL SHUTDOWN BUTTONS

The 2 Buttons present on the Interface should be used to control the Power ON and UNCONDITIONAL SHUTDOWN lines of the module.

The 2 Buttons on the EVK2 could not be used with the GE910 Interface.

28.5. Content of the kit

Please check out the contents of your interface kit; if any of the items is missing, please contact your supplier.

Description	Quantity
GE910 INTERFACE	1
MINI USB CABLE	1



29. GE910-GNSS Interface

This board allows easily interfacing the GE910-GNSS module with the EVK2 and testing their functionalities;
No settings are needed.

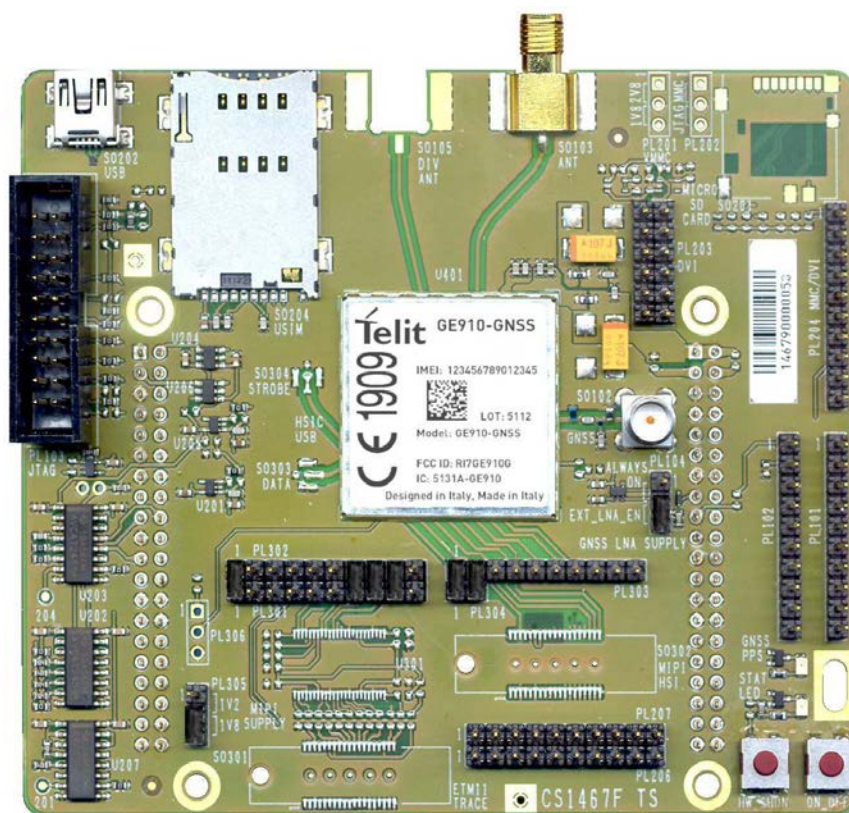

GE910-GNSS Interface Board



29.1. Stand-alone setup

The Jumper setting and the assembled components are ready permitting the standalone use.

29.2. Interface connectors

The following connectors are available:

2 female connectors (40 PTH pins each one: SO101, SO104), to connect the interface to the EVK2 mother board circuits (power supply lines, serial in/out lines, audio in/out lines);

1 USB connector (SO202) related to the GE910-GNSS USB 2.0 port.

2 RF connectors for GSM/GPRS Antenna (SO103) and GNSS antenna (SO102)

1 SIM Holder (SO204)

A group of Male connectors (PL301, PL302, PL303, PL304, PL305, PL102, PL104, PL203) that provide the additional signals (i.e. GPIOs) and could select the functions by Jumper setting (see the related document section/schematic for this).

The following picture is showing the connector's positions and the default settings for the Jumpers.

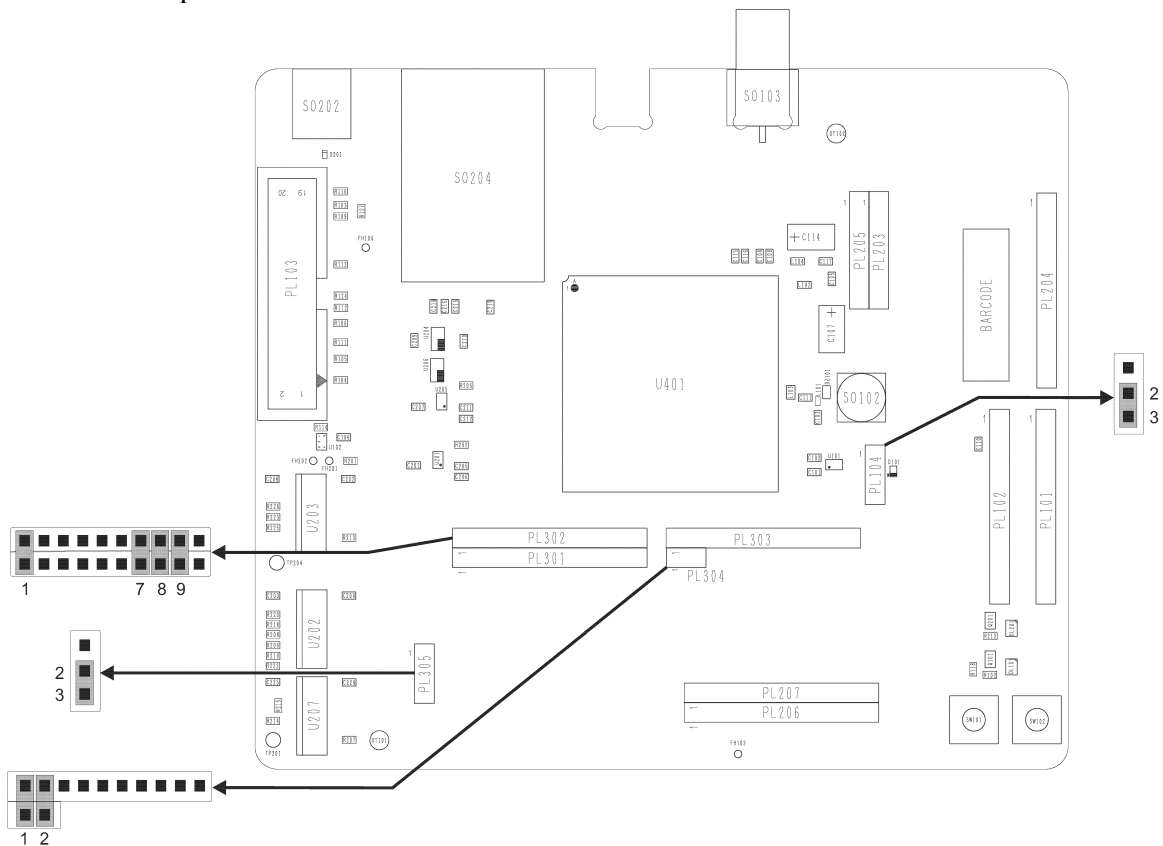

29.3. Antenna connectors

29.3.1. GSM/GPRS Antenna connector

A GSM/GPRS compatible antenna (Refer to the product's HW user guide) antenna must be connected to SO103.

29.3.2. GNSS antenna connector

A GNSS antenna could be connected to SO102. Please refer to the product's HW user guide for the proper type.

The GNSS Antenna (if an active type) could be supplied with a dedicated LDO (3V DC) that could be set in the following way using the Jumpers on PL104.

LDO Enabled by the HE910 Module.

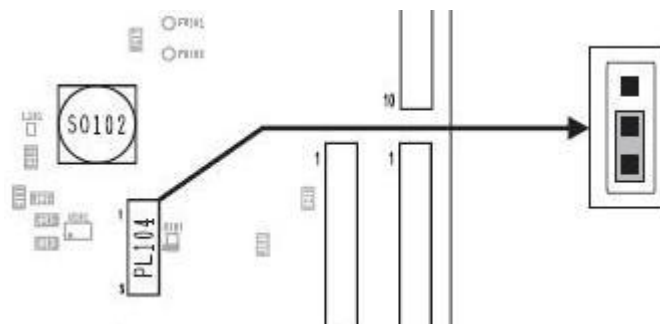

LDO Always Enabled

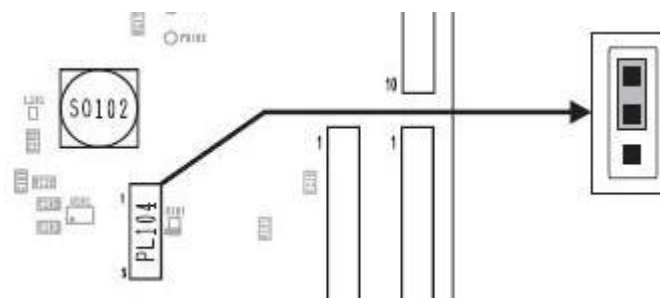

29.4. Expansion Connectors

29.4.1. PL301/PL302

The connectors are carrying the following signals:

PL301		
Pin#	Pin Name	Description
1	STAT_LED	Status Led
2	NC	
3	RESERVED	
4	NC	
5	NC	
6	NC	
7	C125/RING	
8	C107/DSR	
9	C109/DCD	
10	RESERVED	

PL302		
Pin#	Pin Name	Description
1	GPIO_01	Jumper to EVK2 Default function is Status Led
2	GPIO_02	
3	GPIO_03	
4	GPIO_04	
5	GPIO_06	
6	GPIO_07	
7	C125/RING	Jumper to EVK2
8	C107/DSR	Jumper to EVK2
9	C109/DCD	Jumper to EVK2
10	RESERVED	



29.4.2. PL303/PL304

The connectors are carrying the following signals:

PL303		
Pin#	Pin Name	Description
1	TX_AUX	Auxiliary serial port (TX)
2	RX_AUX	Auxiliary serial port (RX)
3	RESERVED	
4	RESERVED	
5	RESERVED	
6	GPIO_08	
7	GPIO_09	
8	GPIO_10	
9	RESERVED	
10	NC	

PL304		
Pin#	Pin Name	Description
1	TX_AUX	Jumper to EVK2
2	RX_AUX	Jumper to EVK2

29.4.3. PL102

The connector is providing the following signals:

PL102		
Pin#	Pin Name	Description
1	VAUX/PWRMON	Auxiliary supply / Power On Indicator
2	VRTC	RTC Backup
3	RESERVED	
4	RESERVED	
5	RESERVED	
6	GPIO_05	GPIO
7	RESERVED	
8	RESERVED	
9	RESERVED	
10	GND	



29.4.4. ON_OFF & UNCONDITIONAL SHUTDOWN BUTTONS

The 2 Buttons present on the Interface should be used to control the Power ON and UNCONDITIONAL SHUTDOWN lines of the module.

The 2 Buttons on the EVK2 could not be used with the GE910-GNSS Interface.
For the GNSS capabilities refer to GE910-GNSS Hardware User Guide.

29.5. Content of the kit

Please check out the contents of your interface kit; if any of the items is missing, please contact your supplier.

Description	Quantity
GE910-GNSS INTERFACE	1
MINI USB CABLE	1



30. GE910-QUAD V3 Interface

This board allows easily interfacing the GE910-QUAD V3 module with the EVK2 and testing their functionalities.

No settings are needed.

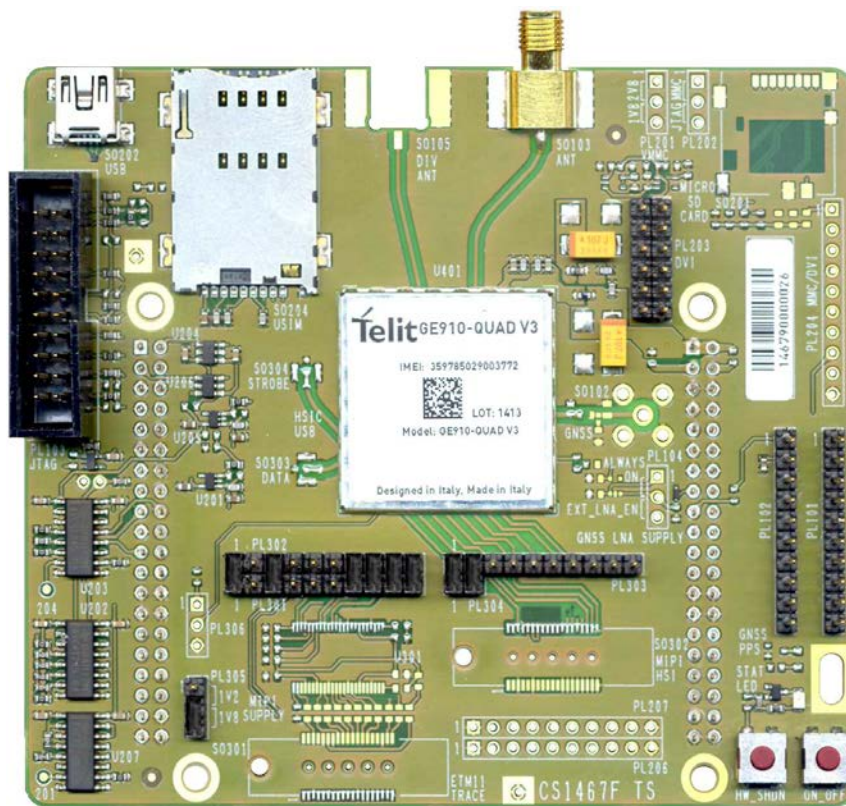

GE910 Interface Board



30.1. Stand-alone setup

The Jumper setting and the assembled components are ready permitting the standalone use.

30.2. Interface connectors

The following connectors are available:

2 female connectors (40 PTH pins each one: SO101, SO104), to connect the interface to the EVK2 mother board circuits (power supply lines, serial in/out lines, audio in/out lines);

1 USB connector (SO202) related to the GE910 USB 2.0 port.

1 RF connectors for GSM/GPRS Antenna (SO103),

1 SIM Holder (SO204)

A group of Male connectors (PL301, PL302, PL303, PL304, PL305, PL102, PL203) that provide the additional signals (i.e. GPIOs) and could select the functions by Jumper setting (see the related document section/schematic for this).

The following picture is showing the connector's positions and the default settings for the Jumpers.

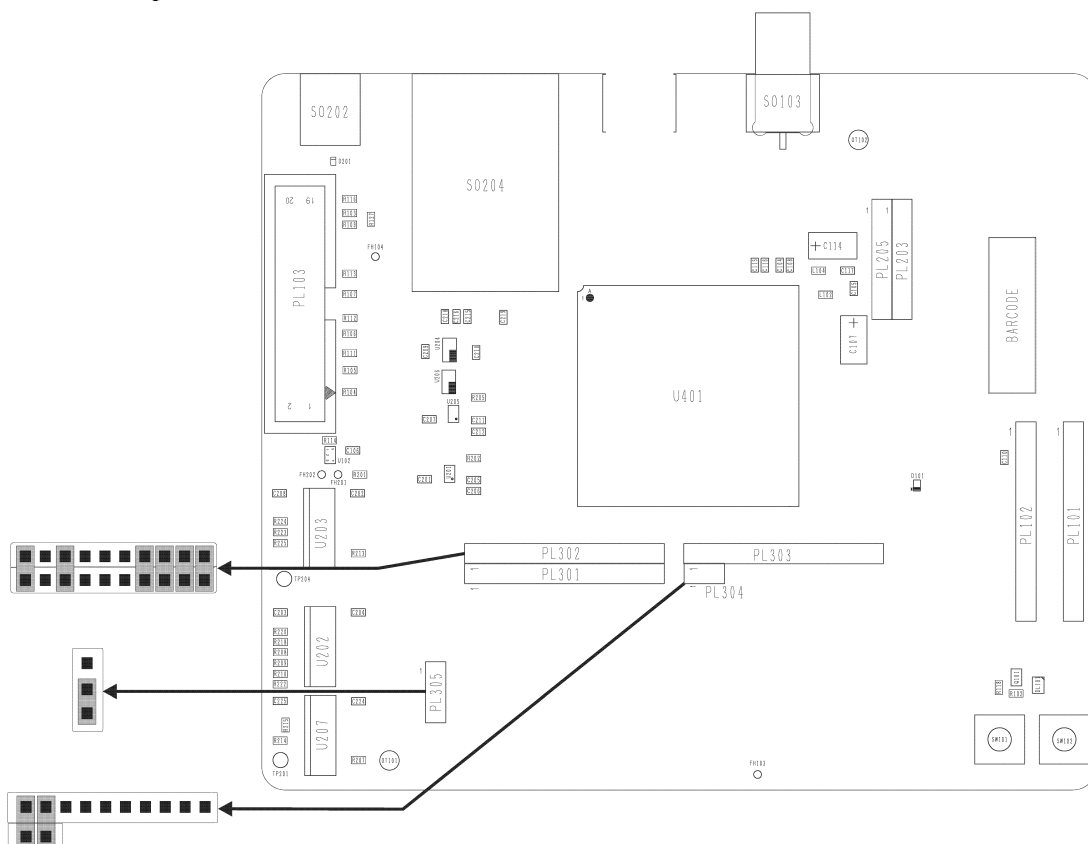

30.4.2. PL303/PL304

The connectors are carrying the following signals:

PL303		
Pin#	Pin Name	Description
1	TX_AUX	Auxiliary serial port (TX)
2	RX_AUX	Auxiliary serial port (RX)
3	RESERVED	
4	RESERVED	
5	RESERVED	
6	GPIO_08	
7	GPIO_09	
8	GPIO_10	
9	RESERVED	
10	NC	

PL304		
Pin#	Pin Name	Description
1	TX_AUX	Jumper to EVK2
2	RX_AUX	Jumper to EVK2

30.4.3. PL102

The connector is providing the following signals:

PL102		
Pin#	Pin Name	Description
1	VAUX/PWRMON	Auxiliary supply / Power On Indicator
2	VRTC	RTC Backup
3	RESERVED	
4	RESERVED	
5	RESERVED	
6	GPIO_05	GPIO
7	RESERVED	
8	RESERVED	
9	RESERVED	
10	GND	



30.4.4. ON_OFF & UNCONDITIONAL SHUTDOWN BUTTONS

The 2 Buttons present on the Interface should be used to control the Power ON and UNCONDITIONAL SHUTDOWN lines of the module.

The 2 Buttons on the EVK2 could not be used with the GE910 Interface.

30.5. Content of the kit

Please check out the contents of your interface kit; if any of the items is missing, please contact your supplier.

Description	Quantity
GE910 INTERFACE	1
MINI USB CABLE	1



31. DE910 family Interface

This board allows easily interfacing the DE910 modules with the EVK2 and testing their functionalities;
No settings are needed.



DE910 Interface Board



31.1. Stand-alone setup

The Jumper setting and the assembled components are ready permitting the standalone use.

31.2. Interface connectors

The following connectors are available:

2 female connectors (40 PTH pins each one: SO101, SO104), to connect the interface to the EVK2 mother board circuits (power supply lines, serial in/out lines, audio in/out lines);

1 USB connector (SO202) related to the DE910 USB 2.0 port.

3 RF connectors for CDMA Antenna (SO103), Receiver Diversity Antenna (SO105) and GPS Antenna (SO102)

1 RUIM Holder (SO204)

A group of Male connectors (PL301, PL302, PL303, PL304, PL102, PL203, PL204) that provide the additional signals (i.e. GPIOs) and could select the functions by Jumper setting (see the related document section/schematic for this).

The following picture is showing the connector's positions and the default settings for the Jumpers.

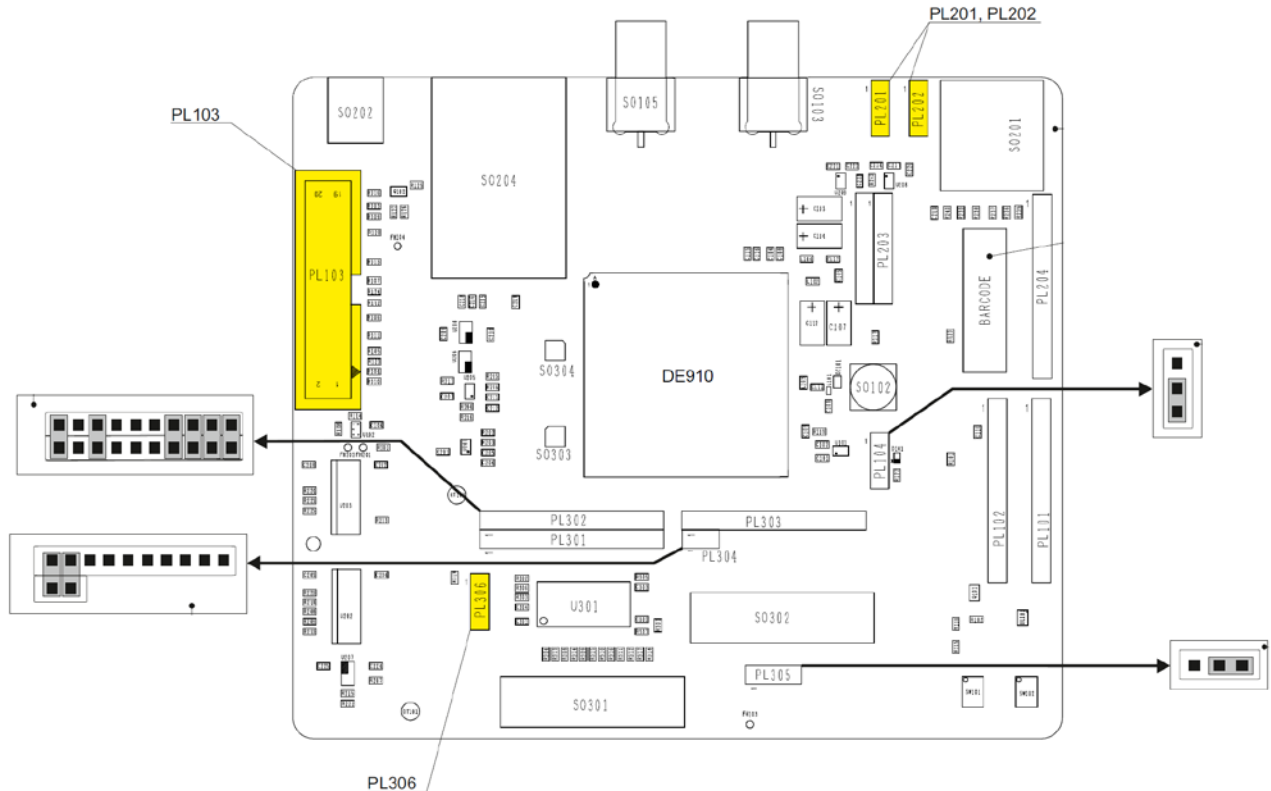

31.3. Antenna connectors

31.3.1. CDMA Antenna connector

A CDMA compatible antenna (Refer to the product's HW user guide) must be connected to SO103.

31.3.2. Receiver Diversity Antenna connector

A CDMA compatible antenna (Refer to the product's HW user guide) could be connected to SO105.

31.3.3. GPS antenna connector

A GPS antenna could be connected to SO102. Please refer to the product's HW user guide for the proper type.

The GPS Antenna (if an active type) could be supplied with a dedicated LDO (3V DC) that could be set in the following way using the Jumpers on PL104.

LDO Enabled by the DE910 Module.

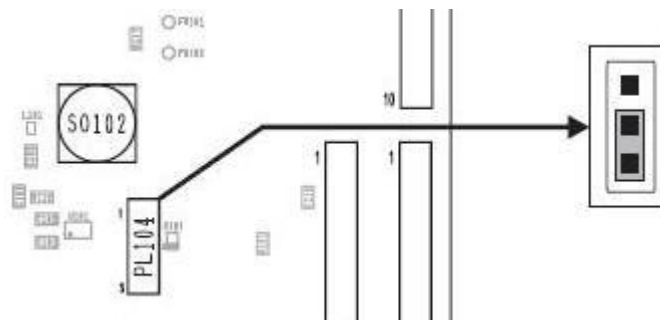

LDO Always Enabled

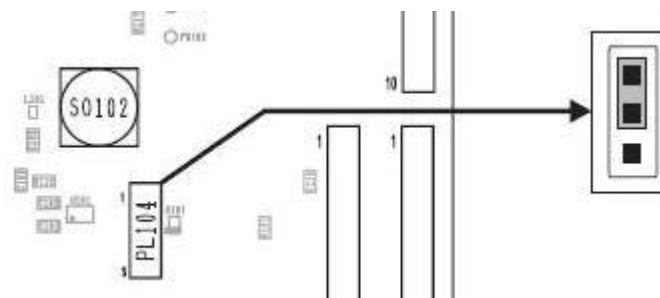

WARNING:

Don't connect a CDMA antenna on this connector



31.4. Expansion Connectors

31.4.1. PL301/PL302

The connectors are carrying the following signals:

PL301		
Pin#	Pin Name	Description
1	STAT_LED	Status Led
2	NC	
3	RESERVED	
4	NC	
5	NC	
6	NC	
7	C125/RING	
8	C107/DSR	
9	C109/DCD	
10	RESERVED	

PL302		
Pin#	Pin Name	Description
1	GPIO_01	Default function is Status Led
2	GPIO_02	
3	GPIO_03	
4	GPIO_04	
5	GPIO_06	
6	GPIO_07	
7	C125/RING	Jumper to EVK2
8	C107/DSR	Jumper to EVK2
9	C109/DCD	Jumper to EVK2
10	RESERVED	Jumper to EVK2



31.4.2. PL303/PL304/PL305

The connectors are carrying the following signals:

PL303		
Pin#	Pin Name	Description
1	TX_AUX	Auxiliary serial port (TX)
2	RX_AUX	Auxiliary serial port (RX)
3	RESERVED	
4	RESERVED	
5	RESERVED	
6	GPIO_08	
7	GPIO_09	
8	GPIO_10	
9	RESERVED	
10	NC	

PL304		
Pin#	Pin Name	Description
1	TX_AUX	Jumper to EVK2
2	RX_AUX	Jumper to EVK2

PL305		
Pin#	Pin Name	Description
1	RESERVED	-
2	VDD_IO	Input pin for the bus supply
3	VIO_1V8	VIO supply at 1.8V



32. CE910 family Interface

This board allows easily interfacing the CE910 modules with the EVK2 and testing their functionalities.

No settings are needed.



CE910 Interface Board



32.1. Stand-alone setup

The Jumper setting and the assembled components are ready permitting the standalone use.

32.2. Interface connectors

The following connectors are available:

- 2 female connectors (40 PTH pins each one: SO101, SO104), to connect the interface to the EVK2 mother board circuits (power supply lines, serial in/out lines, audio in/out lines);
- 1 USB connector (SO202) related to the CE910 USB 2.0 port.
- 1 RF connectors for CDMA Antenna (SO103)
- 1 RUIM Holder (SO204)

A group of Male connectors (PL301, PL302, PL303, PL304, PL102, PL203, PL204) that provide the additional signals (i.e. GPIOs) and could select the functions by Jumper setting (see the related document section/schematic for this).

The following picture is showing the connector's positions and the default settings for the Jumpers.

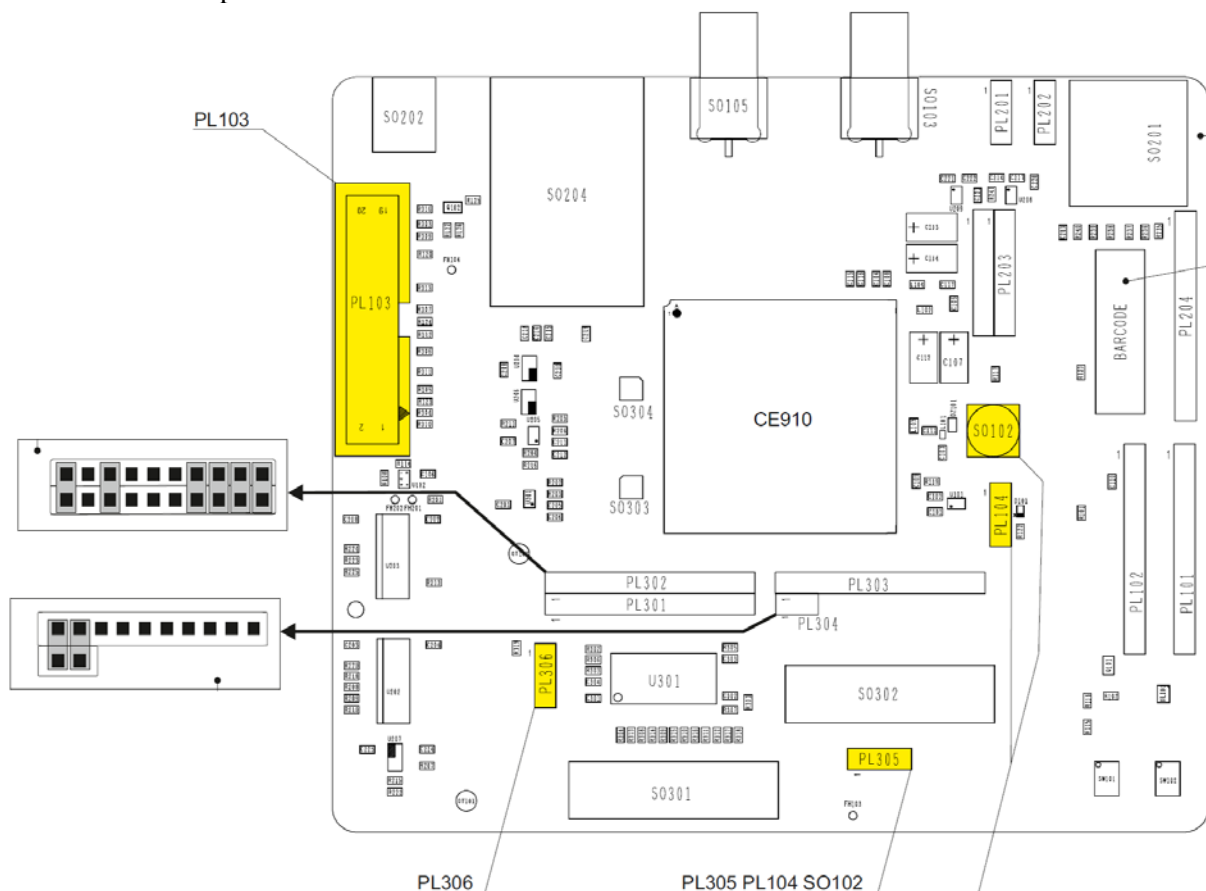

32.3. Antenna connectors

32.3.1. CDMA Antenna connector

A CDMA compatible antenna (Refer to the product’s HW user guide) must be connected to SO103.

32.4. Expansion Connectors

32.4.1. PL301/PL302

The connectors are carrying the following signals:

PL301		
Pin#	Pin Name	Description
1	STAT_LED	Status Led
2	NC	
3	RESERVED	
4	NC	
5	NC	
6	NC	
7	C125/RING	
8	C107/DSR	
9	C109/DCD	
10	RESERVED	

PL302		
Pin#	Pin Name	Description
1	GPIO_01	Default function is Status Led
2	GPIO_02	
3	GPIO_03	
4	GPIO_04	
5	GPIO_06	
6	GPIO_07	
7	C125/RING	Jumper to EVK2
8	C107/DSR	Jumper to EVK2
9	C109/DCD	Jumper to EVK2
10	RESERVED	Jumper to EVK2



32.4.2. PL303/PL304

The connectors are carrying the following signals:

PL303		
Pin#	Pin Name	Description
1	TX_AUX	Auxiliary serial port (TX)
2	RX_AUX	Auxiliary serial port (RX)
3	RESERVED	
4	RESERVED	
5	RESERVED	
6	GPIO_08	
7	GPIO_09	
8	GPIO_10	
9	RESERVED	
10	NC	

PL304		
Pin#	Pin Name	Description
1	TX_AUX	Jumper to EVK2
2	RX_AUX	Jumper to EVK2

32.4.3. PL102

The connector is providing the following signals:

PL102		
Pin#	Pin Name	Description
1	VAUX/PWRMON	Auxiliary supply / Power On Indicator
2	VRTC	RTC Backup
3	RESERVED	
4	RESERVED	
5	RESERVED	
6	GPIO_05	GPIO
7	RESERVED	
8	RESERVED	
9	RESERVED	
10	GND	



32.4.4. ON_OFF & UNCONDITIONAL SHUTDOWN BUTTONS

The 2 Buttons present on the Interface should be used to control the Power ON and UNCONDITIONAL SHUTDOWN lines of the module.

The 2 Buttons on the EVK2 could not be used with the CE910 Interface.

32.5. Content of the kit

Please check out the contents of your interface kit; if any of the items is missing, please contact your supplier.

Description	Quantity
CE910 INTERFACE	1
MINI USB CABLE	1



33. GL865 V3 Interface

This board allows easily interfacing the GL865-DUAL V3 modules with the EVK2 and testing their functionalities.

No settings are needed.

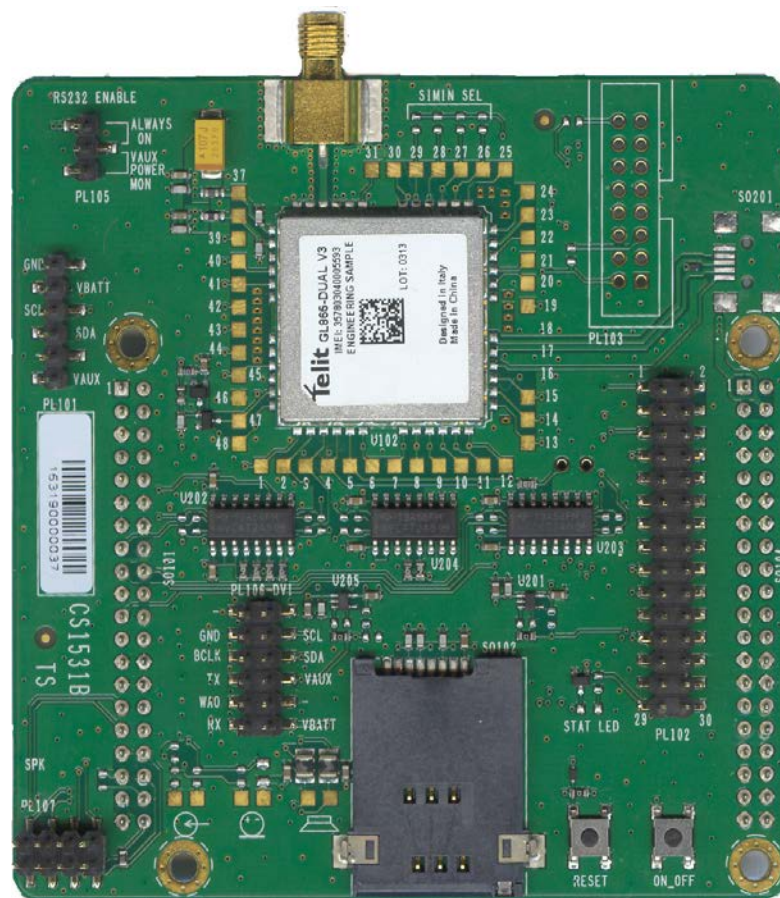

GL865 V3 Interface Board

33.1. Stand-alone setup

The Jumper setting and the assembled components are ready permitting the standalone use.



33.2. Interface connectors

The following connectors are available:

1 male connector (30 SMT pins each one: PL102), by which it is possible to connect external devices, user's application, Telit extension boards, measurements equipment or other tools;
2 female connectors (40 PTH pins each one: SO101, SO104), to connect the interface to the EVK2 mother board circuits (power supply lines, serial in/out lines, audio in/out lines);

1 RF connectors for GSM Antenna (SO103)

1 SIM Holder (SO102)

A group of Male connectors (PL101, PL105, PL106, PL107) that provide the additional signals (i.e. GPIOs) and could select the functions by Jumper setting (see the related document section/schematic for this).

The following picture is showing the connector's positions and the default settings for the Jumpers.

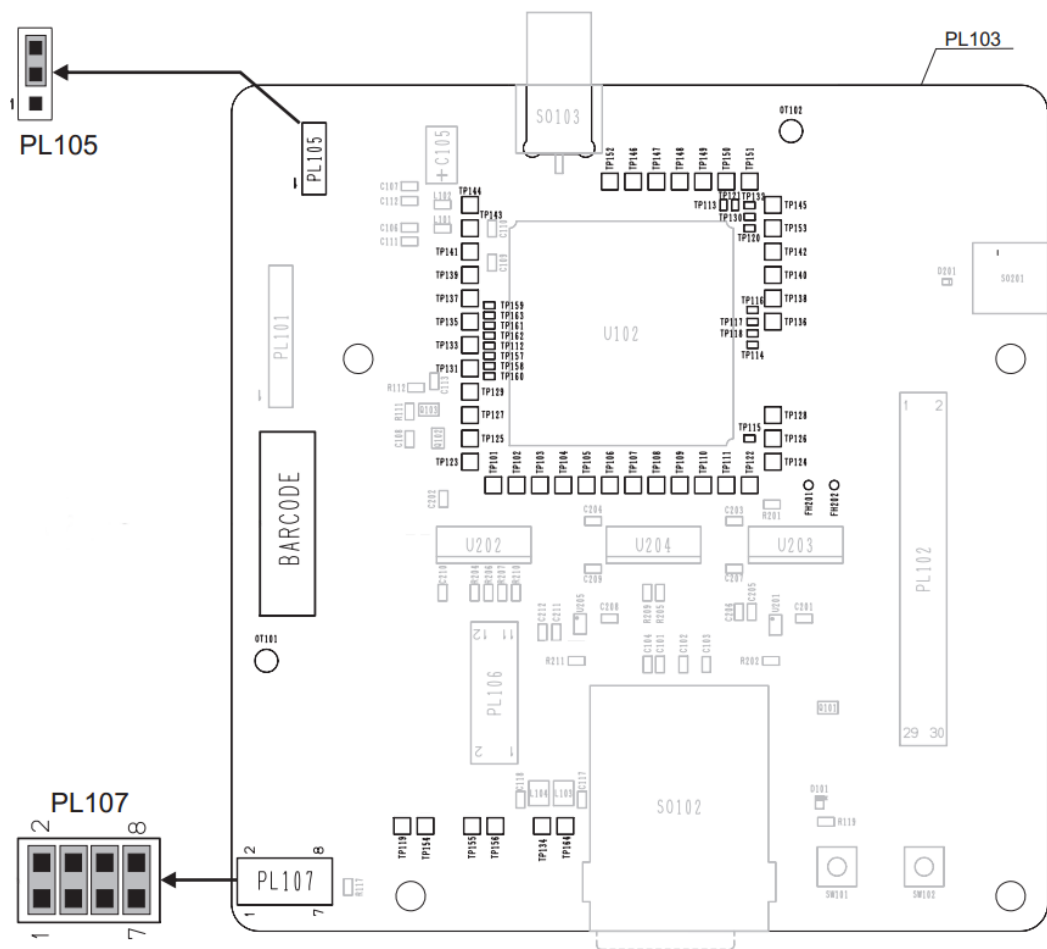

34. LE920 Interface

This board allows easily interfacing the LE920 module with the EVK2 and testing their functionalities.

No settings are needed.



LE920 Interface Board



34.1. Stand-alone setup

The Jumper setting and the assembled components are ready permitting the standalone use.

34.2. Interface connectors

The following connectors are available:

2 female connectors (40 PTH pins each one: SO101, SO104), to connect the interface to the EVK2 mother board circuits (power supply lines, serial in/out lines, audio in/out lines);

1 USB connector (SO202) related to the LE920 USB 2.0 port.

3 RF connectors for Main, Diversity, and GPS Antenna (SO105, SO107, SO108),

1 SIM Holder (SO204)

A group of Male connectors (PL102, PL104), that provide the additional signals

The following picture is showing the connector's positions and the default settings for the Jumpers.

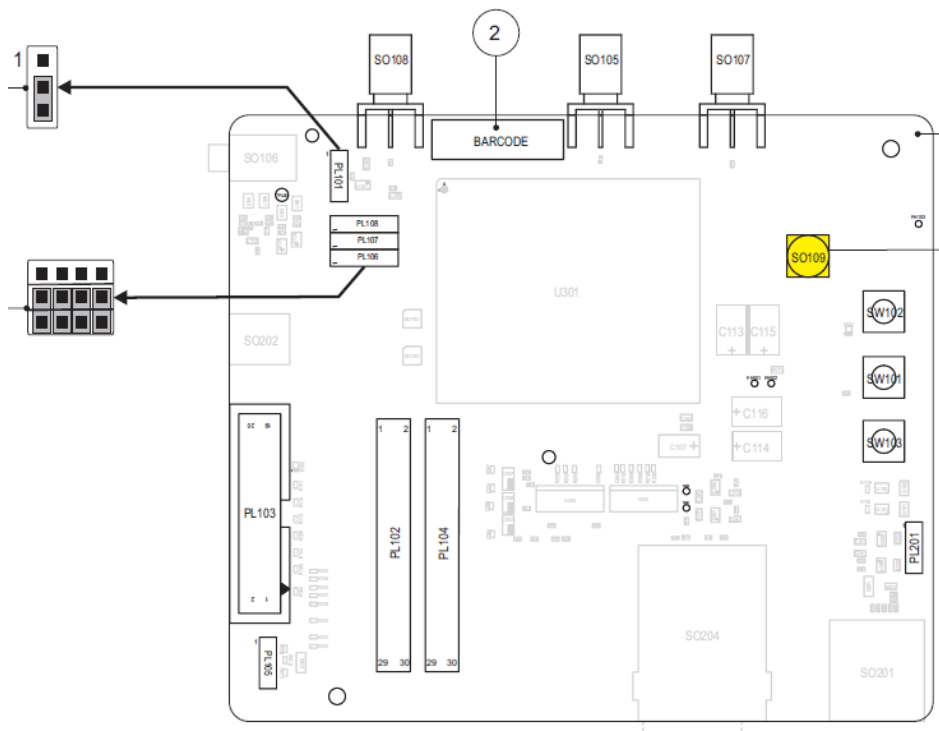

20	TGPIO_04	
21	RESERVED	
22	RESERVED	
23	RESERVED	
24	RESERVED	
25	TGPIO_01	
26	RESERVED	
27	RESERVED	
28	NC	
29	GND	
30	RESERVED	

PL104		
Pin#	Pin Name	Description
1	TGPIO_05	
2	TGPIO_07	
3	NC	
4	NC	
5	TGPIO_08	
6	TGPIO_09	
7	TGPIO_10	
8	TGPIO_03	
9	RESERVED	
10	RESERVED	
11	RESERVED	
12	TGPIO_06	
13	RESERVED	
14	RESERVED	
15	NC	
16	VAUX	1.8V
17	NC	
18	VRTC	
19	ADC1	
20	ADC2	
21	ADC3	
22	RESERVED	
23	TGPIO_02	
24	VBAT	
25	VBAT	
26	GND	
27	RESERVED	
28	RESERVED	
29	VBAT	
30	VBAT	



34.4.2. ON_OFF & UNCONDITIONAL SHUTDOWN, RESET BUTTONS

The 3 Buttons present on the Interface should be used to control the Power ON and UNCONDITIONAL SHUTDOWN, and RESET lines of the module.

34.5. Content of the kit

Please check out the contents of your interface kit; if any of the items is missing, please contact your supplier.

Description	Quantity
LE920 INTERFACE	1
MINI USB CABLE	1



35. HE920 Family Interface

This board allows easily interfacing the HE920 module with the EVK2 and testing their functionalities.

No settings are needed.

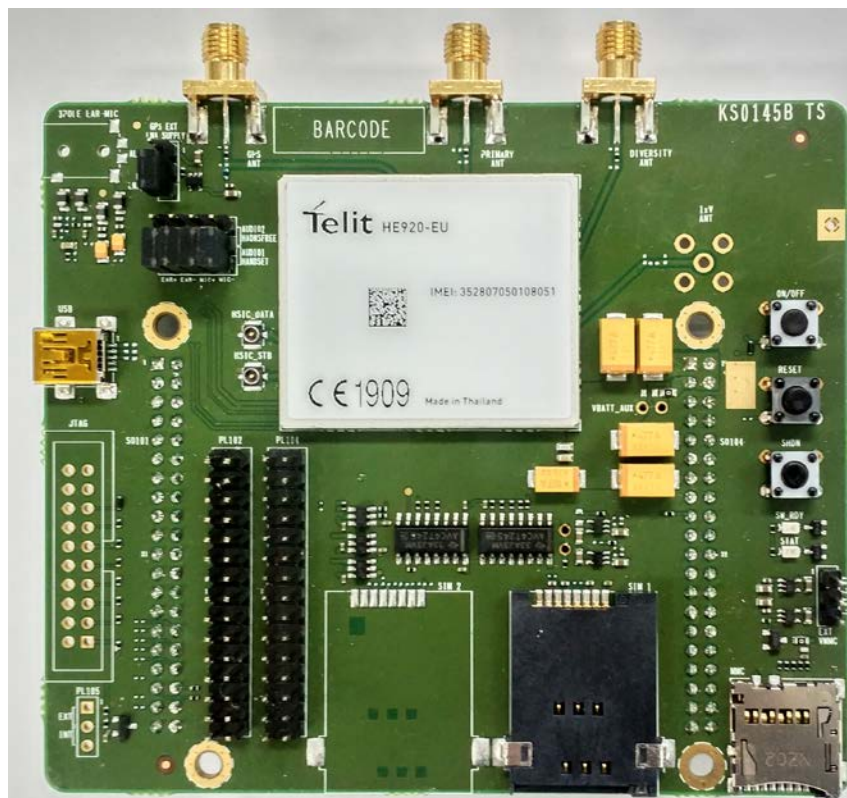

HE920 Interface Board



35.1. Stand-alone setup

The Jumper setting and the assembled components are ready permitting the standalone use.

35.2. Interface connectors

The following connectors are available:

2 female connectors (40 PTH pins each one: SO101, SO104), to connect the interface to the EVK2 mother board circuits (power supply lines, serial in/out lines, audio in/out lines);

1 USB connector (SO202) related to the LE920 USB 2.0 port.

3 RF connectors for Main, Diversity, and GPS Antenna (SO105, SO107, SO108),

1 SIM Holder (SO204)

A group of Male connectors (PL102, PL104), that provide the additional signals

The following picture is showing the connector's positions and the default settings for the Jumpers.

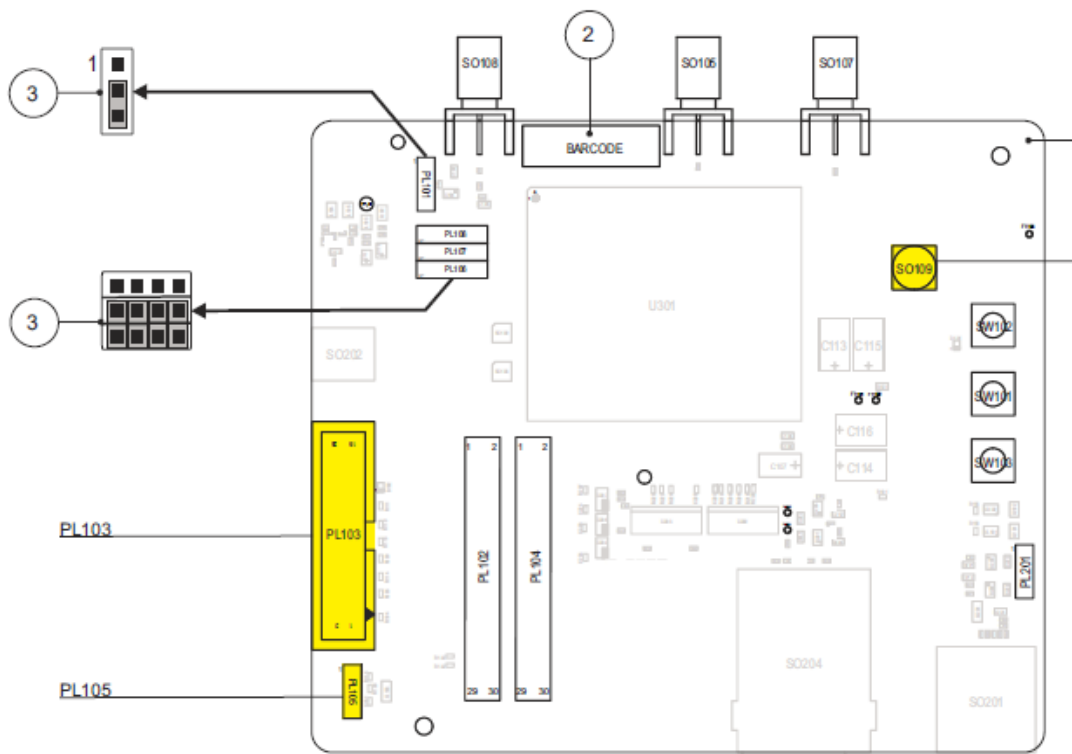

35.3. Antenna connectors

35.3.1. Main Antenna connector

A WCDMA/HsPA/GSM/GPRS compatible antenna (Refer to the product’s HW user guide) antenna must be connected to SO105.

35.3.2. Diversity Antenna connector

A WCDMA/HsPA diversity (secondary) compatible antenna (Refer to the product’s HW user guide) antenna must be connected to SO107.

35.3.3. GPS Antenna connector

A GPS compatible antenna (Refer to the product’s HW user guide) antenna must be connected to SO108.

35.4. Expansion Connectors

35.4.1. PL102/PL104

The connectors are carrying the following signals:

PL102		
Pin#	Pin Name	Description
1	DVI RX	Digital Audio
2	DVI TX	Digital Audio
3	DVI_WA0	Digital Audio
4	DVI_CLK	Digital Audio
5	GND	
6	REF_CLK	
7	GND	
8	RESERVED	
9	RESERVED	
10	RESERVED	
11	RESERVED	
12	GND	
13	NC	
14	NC	
15	GND	
16	GND	
17	RESERVED	
18	NC	
19	RESERVED	



20	TGPIO_04	
21	RESERVED	
22	RESERVED	
23	RESERVED	
24	RESERVED	
25	TGPIO_01	
26	RESERVED	
27	RESERVED	
28	NC	
29	GND	
30	RESERVED	

		PL104
Pin#	Pin Name	Description
1	TGPIO_05	
2	TGPIO_07	
3	NC	
4	NC	
5	TGPIO_08	
6	TGPIO_09	
7	TGPIO_10	
8	TGPIO_03	
9	RESERVED	
10	RESERVED	
11	RESERVED	
12	TGPIO_06	
13	RESERVED	
14	RESERVED	
15	NC	
16	VAUX	1.8V
17	NC	
18	VRTC	
19	ADC1	
20	ADC2	
21	ADC3	
22	RESERVED	
23	TGPIO_02	
24	VBAT	
25	VBAT	
26	GND	
27	RESERVED	
28	RESERVED	
29	VBAT	
30	VBAT	



36. HE910 V2 family Interface

This board allows easily interfacing the HE910 V2 modules with the EVK2 and testing their functionalities;

No settings are needed.

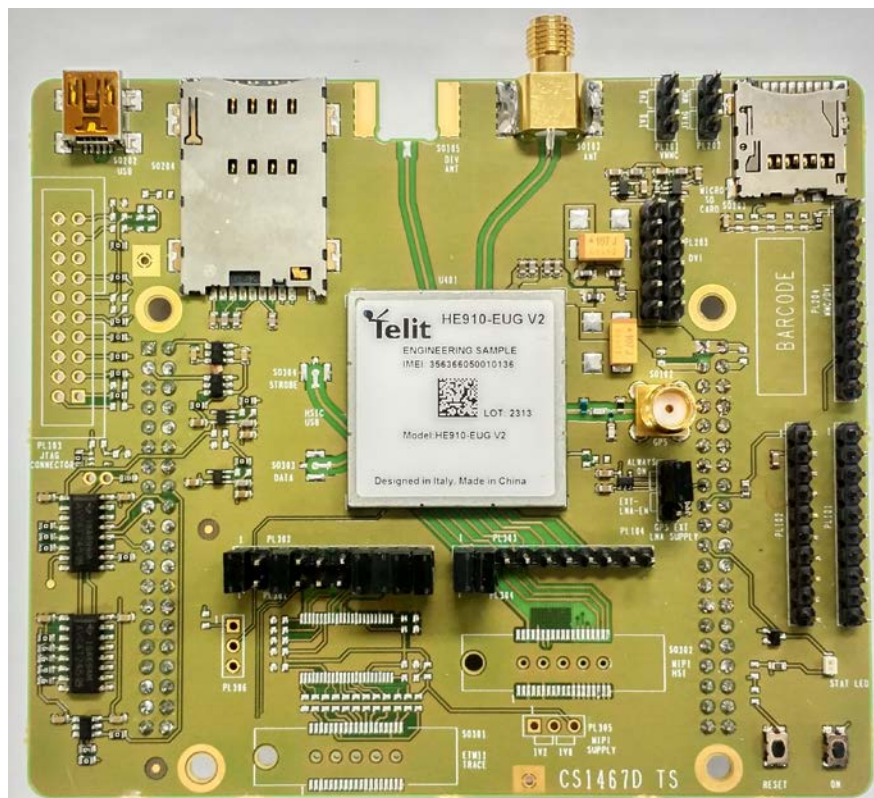

HE910 V2 Interface Board



36.1. Stand-alone setup

The Jumper setting and the assembled components are ready permitting the standalone use.

36.2. Interface connectors

The following connectors are available:

2 female connectors (40 PTH pins each one: SO101, SO104), to connect the interface to the EVK2 mother board circuits (power supply lines, serial in/out lines, audio in/out lines);

1 USB connector (SO202) related to the HE910 V2 USB 2.0 port.

2 RF connectors for GSM/UMTS Antenna (SO103) and GPS Antenna (SO102)

1 SIM Holder (SO204)

A group of Male connectors (PL301, PL302, PL303, PL304) that provide the additional signals (i.e. GPIOs) and could select the functions by Jumper setting (see the related document section/schematic for this).

The following picture is showing the connector's positions and the default settings for the Jumpers.

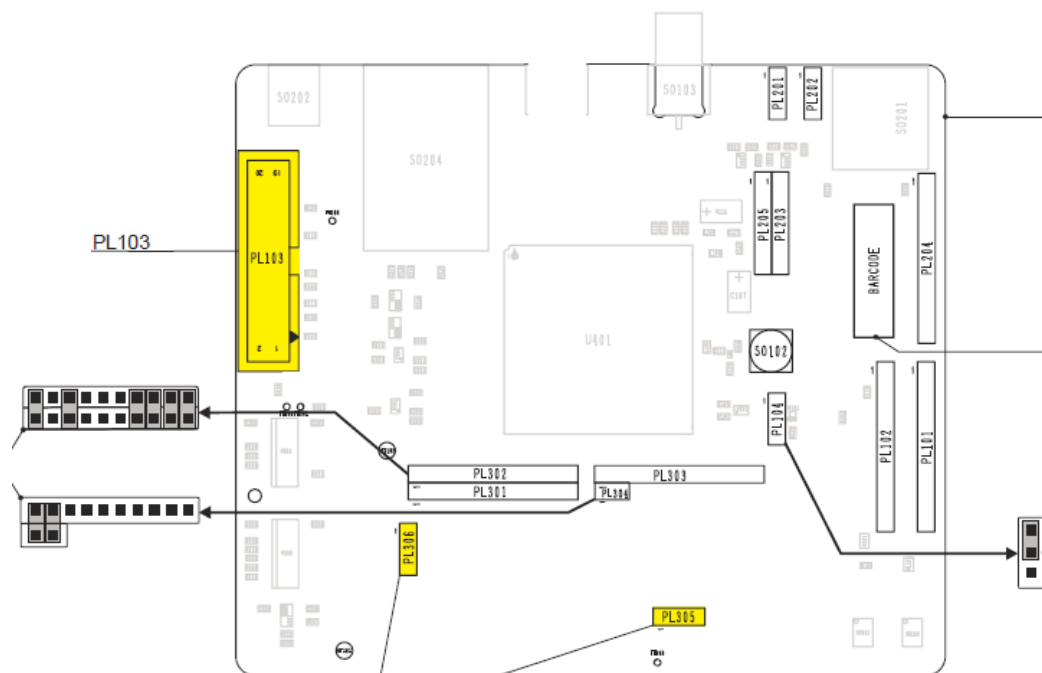

36.3. Antenna connectors

36.3.1. GSM/UMTS Antenna connector

A GSM/UMTS compatible antenna (Refer to the product’s HW user guide) antenna must be connected to SO103.

36.3.2. GPS antenna connector

A GPS antenna could be connected to SO102. Please refer to the product’s HW user guide for the proper type.

The GPS Antenna (if an active type) could be supplied with a dedicated LDO (3V DC) that could be set in the following way using the Jumpers on PL104.

LDO Enabled by the HE910 V2 Module.

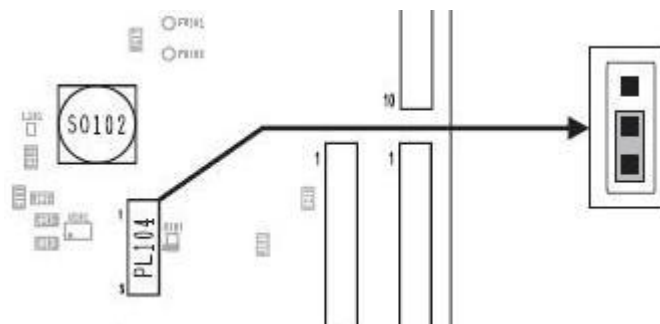

LDO Always Enabled

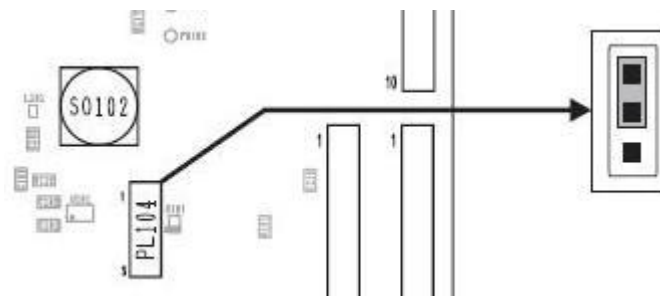

WARNING:

Don't connect a *GSM/UMTS* antenna on this connector



36.4. Expansion Connectors

36.4.1. PL301/PL302

The connectors are carrying the following signals:

PL301		
Pin#	Pin Name	Description
1	STAT_LED	Status Led
2	NC	
3	RESERVED	
4	NC	
5	NC	
6	NC	
7	C125/RING	
8	C107/DSR	
9	C109/DCD	
10	RESERVED	

PL302		
Pin#	Pin Name	Description
1	GPIO_01	Default function is Status Led
2	GPIO_02	
3	GPIO_03	
4	GPIO_04	
5	GPIO_06	
6	GPIO_07	
7	C125/RING	Jumper to EVK2
8	C107/DSR	Jumper to EVK2
9	C109/DCD	Jumper to EVK2
10	RESERVED	Jumper to EVK2



36.4.2. PL303/PL304/PL305

The connectors are carrying the following signals:

PL303		
Pin#	Pin Name	Description
1	TX_AUX	Auxiliary serial port (TX)
2	RX_AUX	Auxiliary serial port (RX)
3	SPI_CLK	SPI
4	SPI_MRDY	SPI
5	SPI_SRDY	SPI
6	GPIO_08	
7	GPIO_09	
8	GPIO_10	
9	RESERVED	
10	NC	

PL304		
Pin#	Pin Name	Description
1	TX_AUX	Jumper to EVK2
2	RX_AUX	Jumper to EVK2

PL305		
Pin#	Pin Name	Description
1	RESERVED	-
2	VDD_IO	Input pin for the bus supply
3	VIO_1V8	VIO supply at 1.8V



37. UE910 V2 family Interface

This board allows easily interfacing the UE910 V2 modules with the EVK2 and testing their functionalities;
No settings are needed.

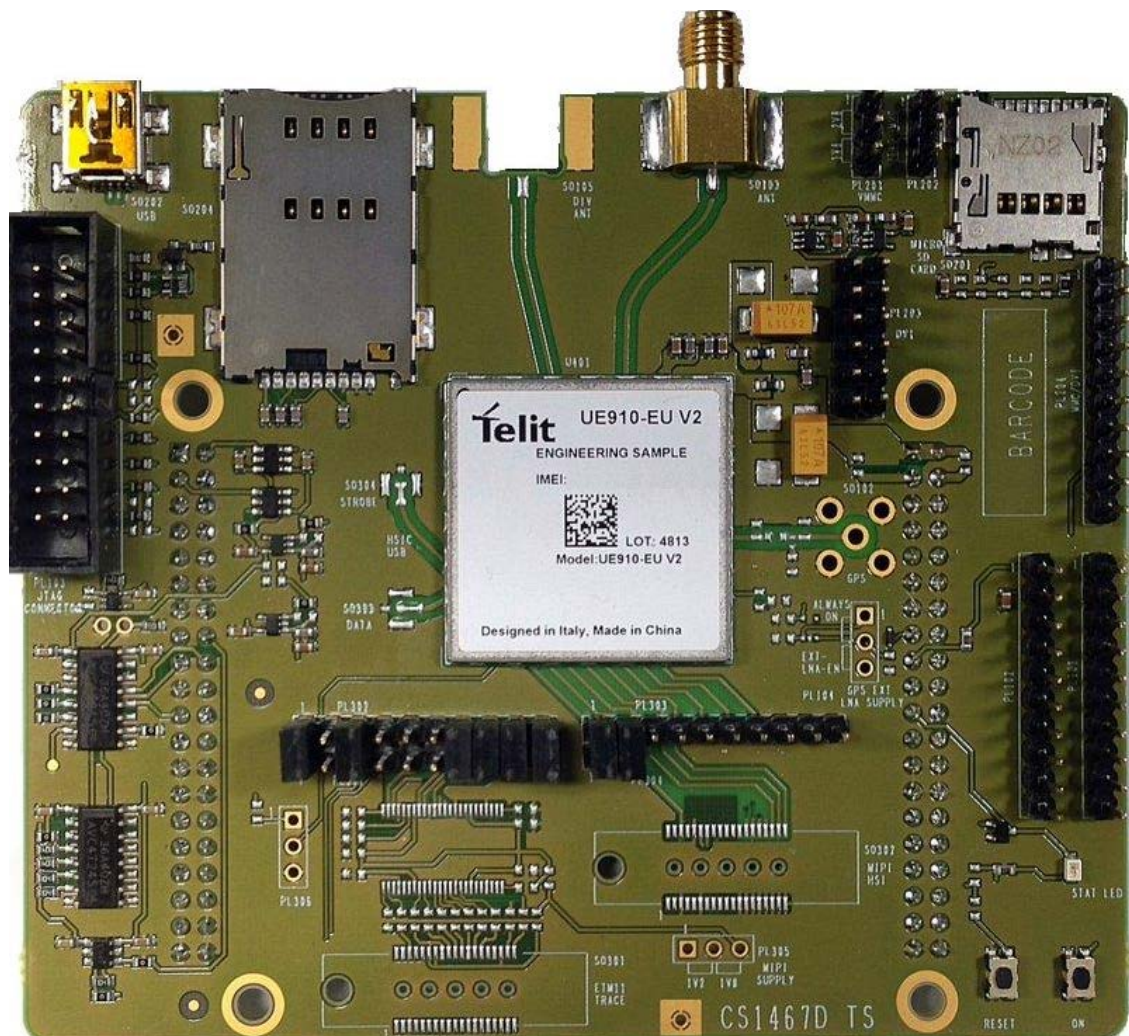

UE910 V2 Interface Board



37.1. Stand-alone setup

The Jumper setting and the assembled components are ready permitting the standalone use.

37.2. Interface connectors

The following connectors are available:

2 female connectors (40 PTH pins each one: SO101, SO104), to connect the interface to the EVK2 mother board circuits (power supply lines, serial in/out lines, audio in/out lines);

1 USB connector (SO202) related to the UE910 V2 USB 2.0 port.

2 RF connectors for GSM/UMTS Antenna (SO103) and GPS Antenna (SO102)

1 SIM Holder (SO204)

A group of Male connectors (PL301, PL302, PL303, PL304) that provide the additional signals (i.e. GPIOs) and could select the functions by Jumper setting (see the related document section/schematic for this).

The following picture is showing the connector's positions and the default settings for the Jumpers.

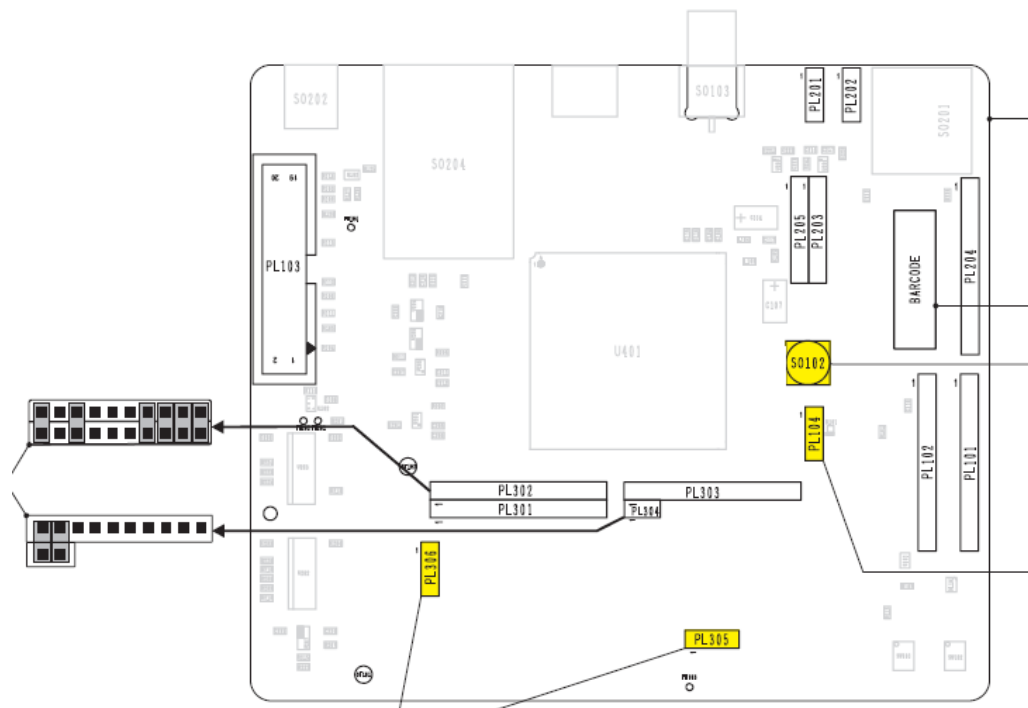

37.3. Antenna connectors

37.3.1. GSM/UMTS Antenna connector

A GSM/UMTS compatible antenna (Refer to the product’s HW user guide) antenna must be connected to SO103.

37.4. Expansion Connectors

37.4.1. PL301/PL302

The connectors are carrying the following signals:

PL301		
Pin#	Pin Name	Description
1	STAT_LED	Status Led
2	NC	
3	RESERVED	
4	NC	
5	NC	
6	NC	
7	C125/RING	
8	C107/DSR	
9	C109/DCD	
10	RESERVED	

PL302		
Pin#	Pin Name	Description
1	GPIO_01	Default function is Status Led
2	GPIO_02	
3	GPIO_03	
4	GPIO_04	
5	GPIO_06	
6	GPIO_07	
7	C125/RING	Jumper to EVK2
8	C107/DSR	Jumper to EVK2
9	C109/DCD	Jumper to EVK2
10	RESERVED	Jumper to EVK2



38. CL865 Interface

This board allows easily interfacing the CL865 modules with the EVK2 and testing their functionalities.

No settings are needed.



CL865 Interface Board

38.1. Stand-alone setup

The Jumper setting and the assembled components are ready permitting the standalone use.



38.2. Interface connectors

The following connectors are available:

1 male connector (30 SMT pins each one: PL102), by which it is possible to connect external devices, user's application, Telit extension boards, measurements equipment or other tools;
2 female connectors (40 PTH pins each one: SO101, SO104), to connect the interface to the EVK2 mother board circuits (power supply lines, serial in/out lines, audio in/out lines);

1 RF connectors for CDMA Antenna (SO103)

1 SIM Holder (SO102)

A group of Male connectors (PL101, PL105, PL106, PL107) that provide the additional signals (i.e. GPIOs) and could select the functions by Jumper setting (see the related document section/schematic for this).

The following picture is showing the connector's positions and the default settings for the Jumpers.

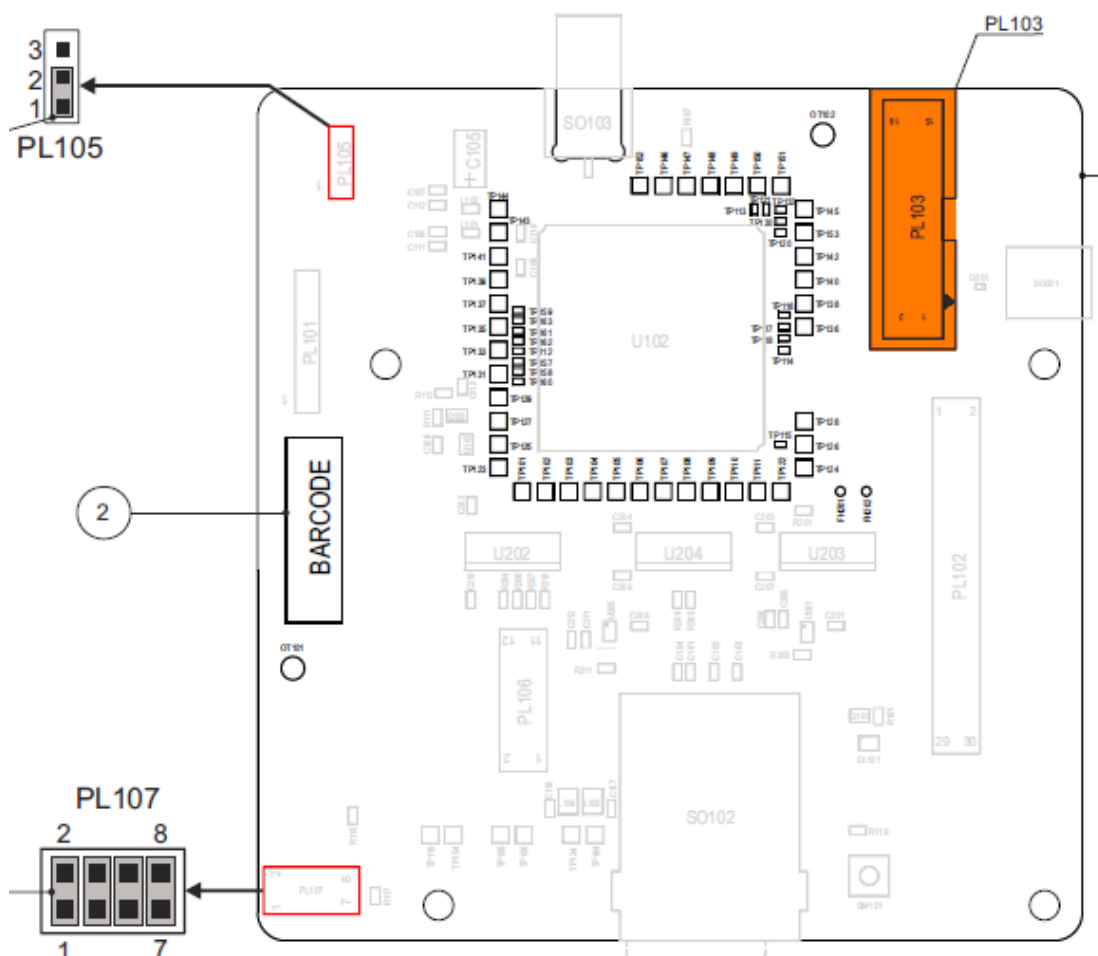

38.3. Antenna connectors

38.3.1. CDMA Antenna connector

A CDMA compatible antenna (Refer to the product’s HW user guide) antenna must be connected to SO103.

38.4. Expansion Connectors

38.4.1. PL101

The connector is carrying the following signals:

PL301		
Pin#	Pin Name	Description
1	VAUX	VAUX/PWRMON
2	NC	
3	SDA	GPIO07 Configurable GPIO (I2C SDA)
4	SCL	GPIO08 Configurable GPIO (I2C SCL)
5	VBATT	
6	GND	

38.4.2. PL106

The connector is carrying the following signals:

PL303		
Pin#	Pin Name	Description
1	VBATT	
2	DVI_RX	Digital Audio Interface (RX)
3	NC	
4	DVI_WA0	Digital Audio Interface (WA0)
5	VAUX	VAUX/PWRMON
6	DVI_TX	Digital Audio Interface (TX)
7	BUZZER	GPIO07 Configurable GPIO
8	DVI_CLK	Digital Audio Interface (CLK)
9	STAT_LED	GPIO08 Configurable GPIO
10	GND	
11	NC	
12	NC	



38.4.3. PL107

The connector is providing the following signals:

PL102		
Pin#	Pin Name	Description
1	EAR_HF+	Audio output path
2	EAR+	Audio output path
3	EAR_HF-	Audio output path
4	EAR-	Audio output path
5	MIC_HF+	Audio input path
6	MIC_HF-	Audio input path
7	MIC-	Audio input path
8	MIC+	Audio input path

The connector allows to isolate audio path going to EVK in order to permit to use the dedicated audio test points on the interface.

38.5. Content of the kit

Please check out the contents of your interface kit; if any of the items is missing, please contact your supplier.

Description	Quantity
CL865 INTERFACE	1



39. GE866-QUAD Interface

This board allows easily interfacing the GE866-QUAD modules with the EVK2 and testing their functionalities.

No settings are needed.

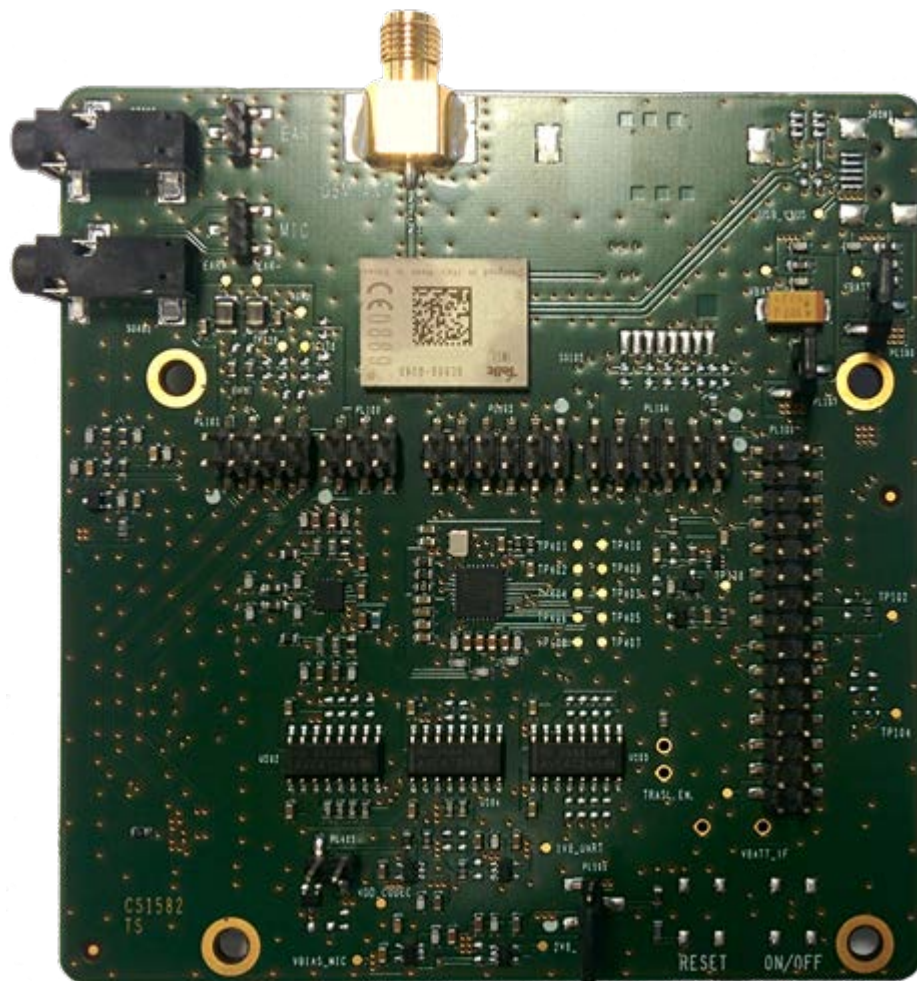

GE866-QUAD Interface Board

39.1. Stand-alone setup

The jumper setting is ready, permitting the standalone use.



39.2. Interface connectors

The following connectors are available:

1 male connector (30 SMT pins each one: PL102), by which it is possible to connect external devices, user's application, Telit extension boards, measurements equipment or other tools;

2 female connectors (40 SMT pins each one: SO101, SO104), to connect the interface to the EVK2 mother board circuits (power supply lines, serial in/out lines, audio in/out lines);

- 1 RF connectors for GSM Antenna (SO103)
- a group of Male connectors (PL101, PL103, PL104, PL108) that provide the additional signals (i.e. GPIOs) and could select the functions by Jumper setting (see the related document section/schematic for this).
- 1 male connector (3 SMT pins, 2 mm pitch: PL105). Jumper on pins 1-2 enables the serial interface only when the GE866-DUAL is powered on. Otherwise, jumper on pin 2-3 will set the serial interface always on.
- 2 3.5mm stereo audio jacks (SO401 and SO402) for connection of microphone and earphones.
- 2 male connectors (3 SMT pins, 2 mm pitch: PL401 and PL402) to provide additional audio input/output interfaces.
- 1 male connector (2 SMT pins, PL403) which enables the supply for the audio codec.

The following picture shows connector's positions and the default setting for the jumpers.

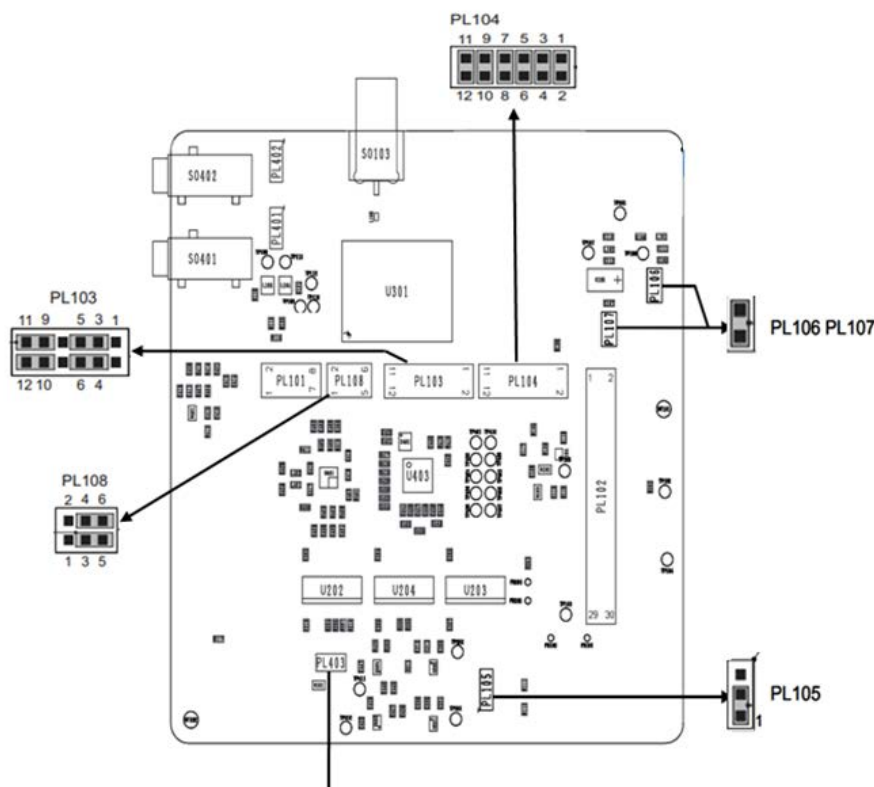

39.3. Antenna connectors

39.3.1. GSM Antenna connector

A GSM compatible antenna (Refer to the product’s HW user guide) antenna must be connected to SO103.

39.4. Expansion Connectors

39.4.1. PL102

The connector carries the following signals:

PL102		
Pin#	Pin Name	Description
1	GPIO_05/RFTXMON	RF transmission monitor
2	GPIO_06/ALARM/BUZZER	Alarm or buzzer output
3	NC	
4	NC	
5	GPIO_07/STAT_LED	Status pin
6	GPIO_01/I2S_WA0	Digital audio interface WA0
7	GPIO_04/I2S_CLK	Digital audio interface Clock
8	GPIO_03/I2S_TX	Digital audio interface TX
9	NC	
10	NC	
11	NC	
12	GPIO_06/ALARM/BUZZER	Alarm or buzzer output
13	NC	
14	NC	
15	NC	
16	V_AUX/PWRMON	Pull-up reference or ON monitor
17	DAC_OUT	10 bit DAC output, 1.8V max
18	VRTC	Real Time Clock supply
19	ADC_IN	11 bit ADC converter, 0-1.2
20	NC	
21	NC	
22	NC	
23	GPIO_02/I2S_RX	Digital audio interface RX
24	NC	
25	NC	
26	NC	
27	NC	
28	NC	
29	VBATT_IF	3.8V supply
30	GND	



39.4.2. PL101

The connector reroutes the balanced audio interfaces of GE866-QUAD (earphone and microphone) to the EVK2 jack connector. The connection is enabled by placing the respective jumpers.

Note that use of PL101 makes sense only when the analog audio is selected.

PL101		
Jumpers on pins#	Connection name	Description
1-2	EAR_HF+	Balanced + earphone output
3-4	EAR_HF-	Balanced - earphone output
5-6	MIC_HF-	Balanced - microphone input
7-8	MIC_HF+	Balanced + microphone input

39.4.3. PL103

PL103 allows rerouting the stereo balanced audio signals to the earphones connectors (PL404 and SO402). The source that can be chosen is either the analog or the digital audio output of the GE866-QUAD.

PL103		
Jumpers on pins#	Signal Name	Description
1-3	Left Out +	Analog audio
2-4	Right Out +	
7-9	Left Out -	
8-10	Right Out -	
3-5	Left Out +	Digital audio
4-6	Right Out +	
9-11	Left Out -	
10-12	Right Out -	

The connector allows isolating audio path going to EVK2 in order to use the dedicated audio test points/connectors on the GE866-QUAD interface.



39.4.7. PL401 and 402

These connectors provide an additional input/output for interfacing an earphone and a microphone to the GE866-QUAD.

Pin 1 is, for both the connectors, the one closest to the upper side of the board (i.e. the side where the GSM antenna connector is mounted).

Pin#	PL401	PL402
1	Microphone right	Earphone right
2	GND	GND
3	Microphone left	Earphone left

39.5. Audio selection

The GE866-QUAD Interface allows choosing between digital or analog audio, as both are supported by the module.

Digital audio has been configured as default

Use the following table as quick reference for the desired setting.

Connector	Analog audio	Digital audio
PL105		1-2
PL106		1-2
PL107		1-2
PL101	Only for EVK2 audio 1-2 3-4 5-6 7-8	no jumpers
PL108	1-3 2-4	3-5 4-6
PL103	1-3 2-4 7-9 8-10	3-5 4-6 9-11 10-12
PL104	no jumpers	1-2 3-4 5-6 7-8 9-10 11-12
PL403	no jumpers	1-2

39.6. Content of the kit

Please check out the contents of your interface kit; if any of the items is missing, please contact your supplier.

Description	Quantity
GE866-QUAD Interface	1
Jumpers	16



40. UL865 Interface

This board allows easily interfacing the UL865 modules with the EVK2 and testing their functionalities.

No settings are needed.

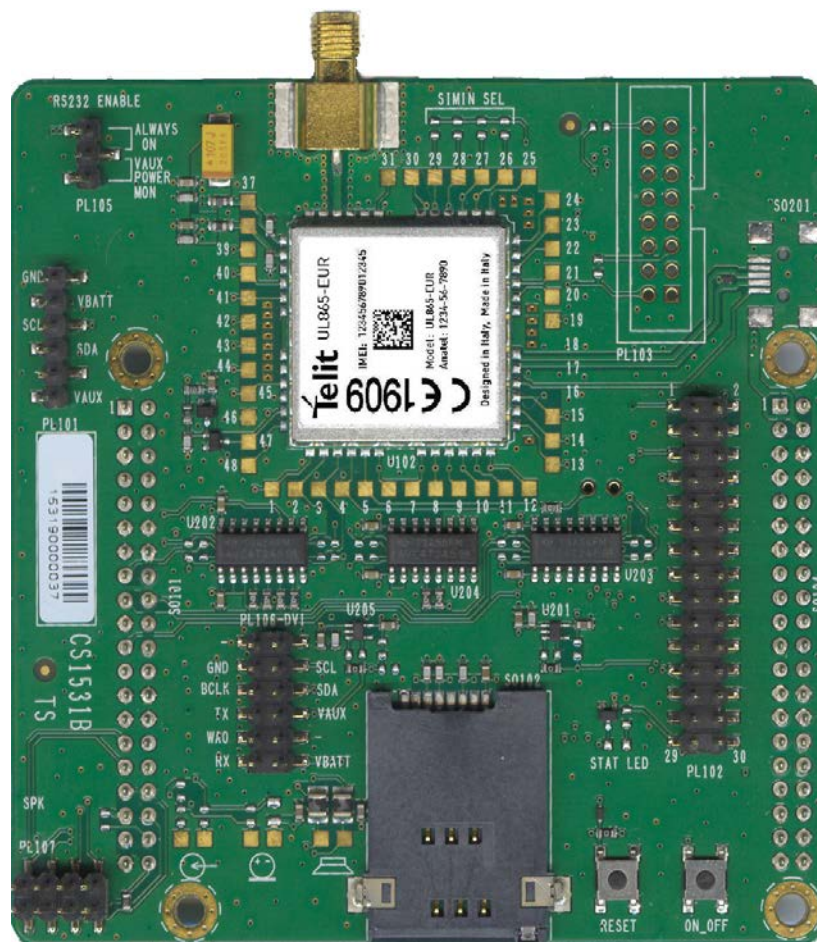

UL865 Interface Board

40.1. Stand-alone setup

The Jumper setting and the assembled components are ready permitting the standalone use.



40.2. Interface connectors

The following connectors are available:

1 male connector (30 SMT pins each one: PL102), by which it is possible to connect external devices, user's application, Telit extension boards, measurements equipment or other tools;
2 female connectors (40 PTH pins each one: SO101, SO104), to connect the interface to the EVK2 mother board circuits (power supply lines, serial in/out lines, audio in/out lines);

1 RF connectors for GSM Antenna (SO103)

1 SIM Holder (SO102)

A group of Male connectors (PL101, PL105, PL106) that provide the additional signals (i.e. GPIOs) and could select the functions by Jumper setting (see the related document section/schematic for this).

The following picture is showing the connector's positions and the default settings for the Jumpers.

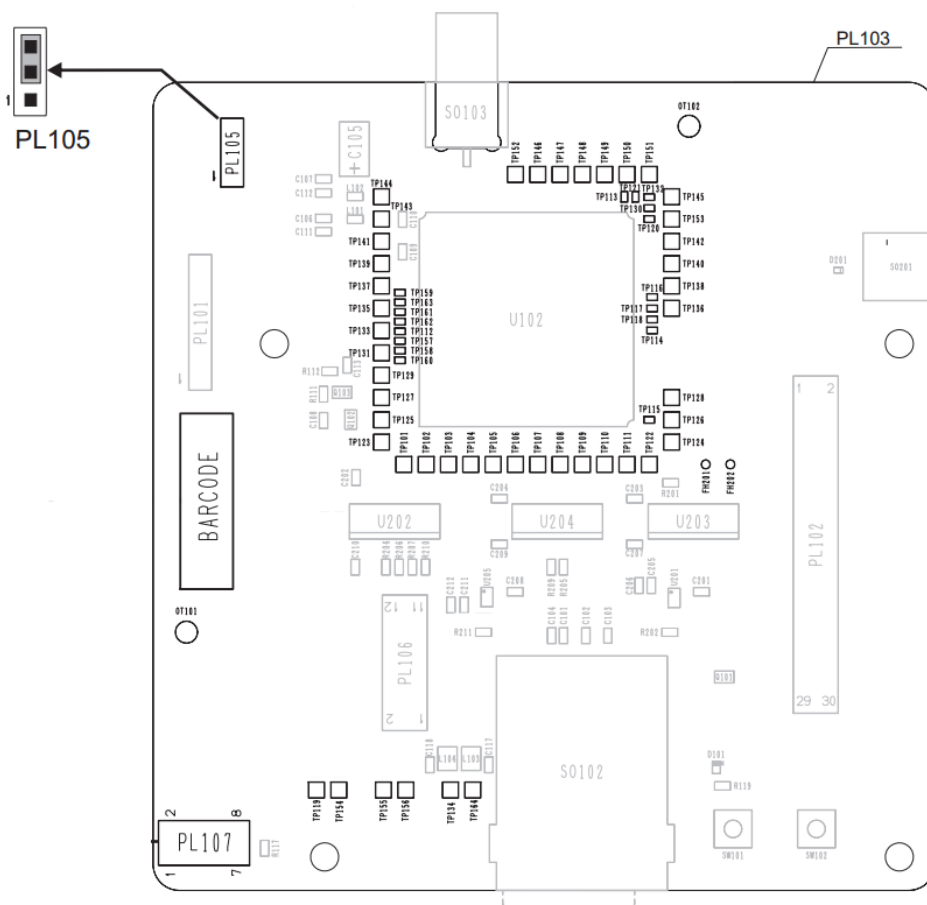

40.3. Antenna connectors

40.3.1. GSM Antenna connector

A GSM compatible antenna (Refer to the product’s HW user guide) antenna must be connected to SO103.

40.4. Expansion Connectors

40.4.1. PL101

The connector is carrying the following signals:

PL301		
Pin#	Pin Name	Description
1	VAUX	VAUX/PWRMON
2	NC	
3	GPIO07	GPIO07 Configurable GPIO
4	GPIO08	GPIO08 Configurable GPIO
5	VBATT	
6	GND	

40.4.2. PL106

The connector is carrying the following signals:

PL303		
Pin#	Pin Name	Description
1	VBATT	
2	DVI_RX	Digital Audio Interface (RX)
3	NC	
4	DVI_WA0	Digital Audio Interface (WA0)
5	VAUX	VAUX/PWRMON
6	DVI_TX	Digital Audio Interface (TX)
7	GPIO7	GPIO07 Configurable GPIO
8	DVI_CLK	Digital Audio Interface (CLK)
9	STAT_LED	GPIO08 Configurable GPIO
10	GND	
11	NC	
12	NC	



40.5. Content of the kit

Please check out the contents of your interface kit; if any of the items is missing, please contact your supplier.

Description	Quantity
UL865 INTERFACE	1



41. LE910 Interface

This board allows easily interfacing the LE910 modules with the EVK2 and testing their functionalities;
No settings are needed.

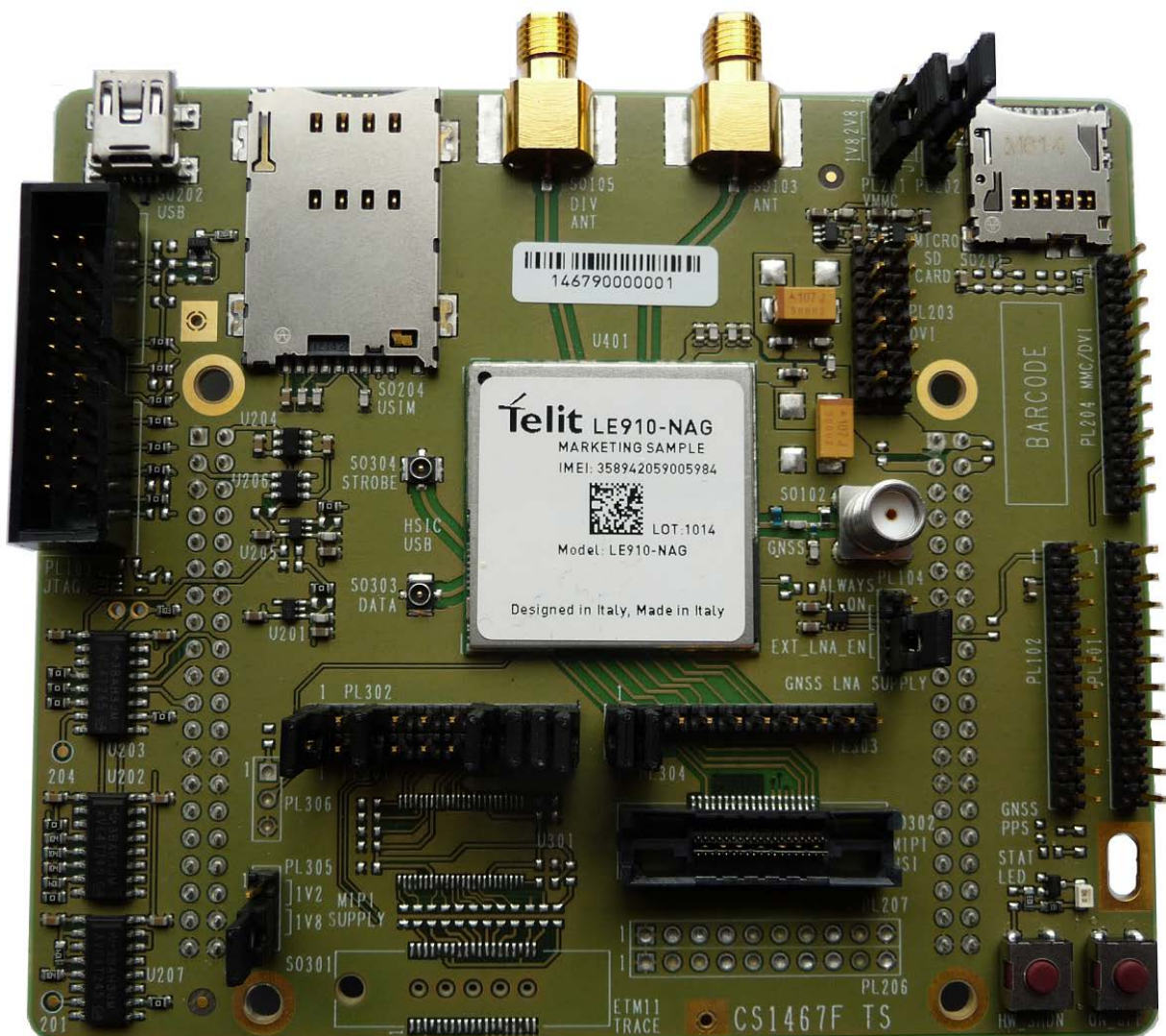

LE910 Interface Board



41.1. Stand-alone setup

The Jumper setting and the assembled components are ready permitting the standalone use.

41.2. Interface connectors

The following connectors are available:

2 female connectors (40 PTH pins each one: SO101, SO104), to connect the interface to the EVK2 mother board circuits (power supply lines, serial in/out lines, audio in/out lines);

1 USB connector (SO202) related to the LE910 USB 2.0 port.

3 RF connectors for Main Antenna (SO103) , Diversity Antenna (SO105) and GNSS antenna (SO102)

1 SIM Holder (SO204)

A group of Male connectors (PL301, PL302, PL303, PL304, PL305, PL102, PL104, PL203) that provide the additional signals (i.e. GPIOs) and could select the functions by Jumper setting (see the related document section/schematic for this).

The following picture is showing the connector's positions and the default settings for the Jumpers.

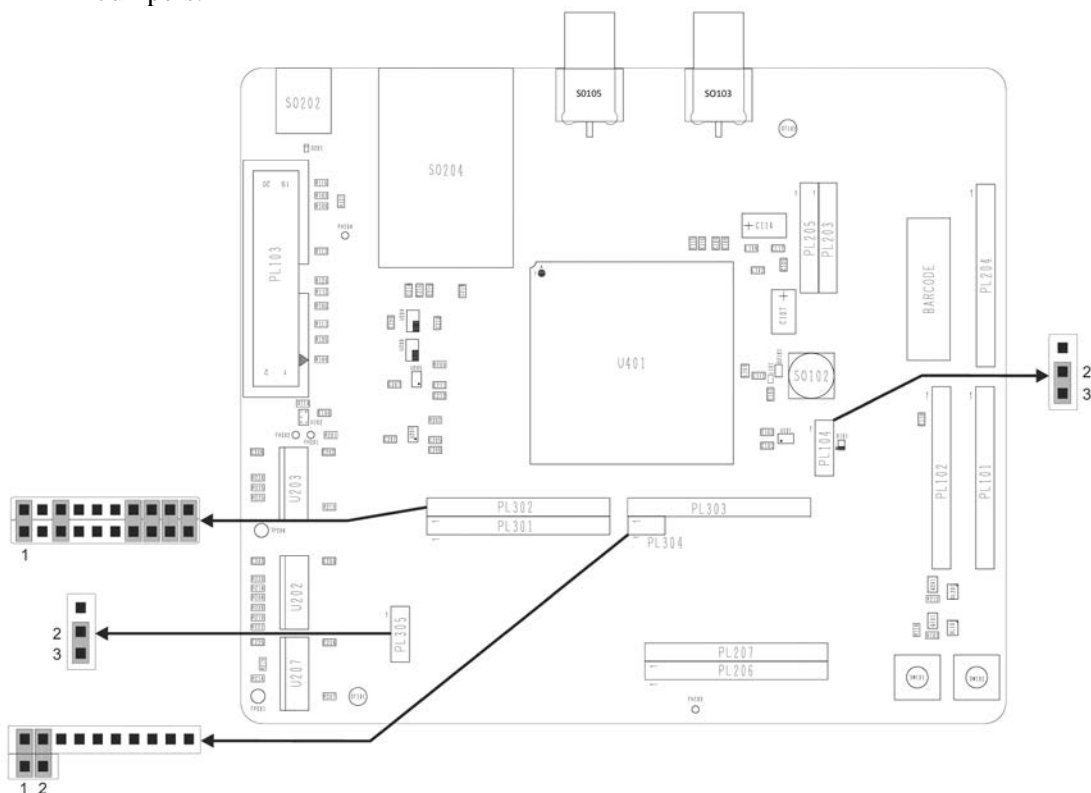

41.4. Expansion Connectors

41.4.1. PL301/PL302

The connectors are carrying the following signals:

PL301		
Pin#	Pin Name	Description
1	STAT_LED	Status Led
2	NC	
3	RESERVED	
4	NC	
5	NC	
6	NC	
7	C125/RING	
8	C107/DSR	
9	C109/DCD	
10	RESERVED	

PL302		
Pin#	Pin Name	Description
1	GPIO_01	Jumper to EVK2 Default function is Status Led
2	GPIO_02	
3	GPIO_03	
4	GPIO_04	
5	GPIO_06	
6	GPIO_07	
7	C125/RING	Jumper to EVK2
8	C107/DSR	Jumper to EVK2
9	C109/DCD	Jumper to EVK2
10	RESERVED	



41.4.2. PL303/PL304

The connectors are carrying the following signals:

PL303		
Pin#	Pin Name	Description
1	TX_AUX	Auxiliary serial port (TX)
2	RX_AUX	Auxiliary serial port (RX)
3	RESERVED	
4	RESERVED	
5	RESERVED	
6	GPIO_08	
7	GPIO_09	
8	GPIO_10	
9	RESERVED	
10	NC	

PL304		
Pin#	Pin Name	Description
1	TX_AUX	Jumper to EVK2
2	RX_AUX	Jumper to EVK2

41.4.3. PL102

The connector is providing the following signals:

PL102		
Pin#	Pin Name	Description
1	VAUX/PWRMON	Auxiliary supply / Power On Indicator
2	VRTC	RTC Backup
3	RESERVED	
4	RESERVED	
5	RESERVED	
6	GPIO_05	GPIO
7	RESERVED	
8	RESERVED	
9	RESERVED	
10	GND	



41.4.4. ON_OFF & UNCONDITIONAL SHUTDOWN BUTTONS

The 2 Buttons present on the Interface should be used to control the Power ON and UNCONDITIONAL SHUTDOWN lines of the module.

The 2 Buttons on the EVK2 could not be used with the LE910 Interface.
For the GNSS capabilities refer to LE910 Hardware User Guide.

41.5. Content of the kit

Please check out the contents of your interface kit; if any of the items is missing, please contact your supplier.

Description	Quantity
LE910 INTERFACE	1
MINI USB CABLE	1



42. GPIO ports

A certain number of GPIO ports (General Purpose Input/Output) are available on every Telit Module Interface Board, giving you the possibility to drive digital devices and report their own status.

Some of these ports are dedicated. Refer to *Telit Product Description* and *Telit Hardware User Guide* to have all information about characteristics of every GPIO port.

You can consult the following paragraphs to see the displacement of GPIO on every Interface Board.



42.1. GPIO location

42.1.1. GM862 Interface

(Refer to schematic diagram 30276SE11150B)

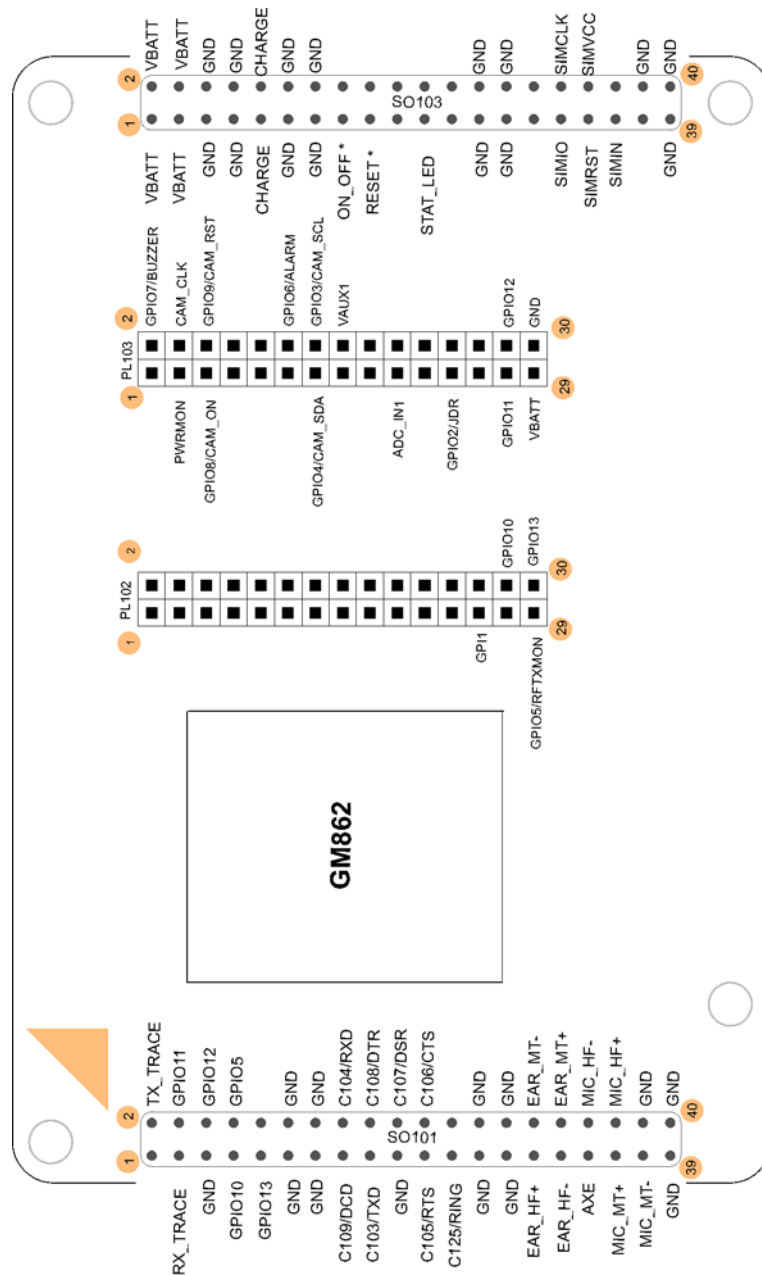

Position of GPIO ports on GM862 interface



Note on GM862-GPS version

If you use this interface in conjunction with GM862-GPS version *be careful* that the following two pins of SO101 connector assume different functions, and precisely:

Pin 2 = TX_GPS

Pin 3 = RX_GPS



42.1.2. GE863-GPS Interface

(Refer to schematic diagram 30276SE11151A)

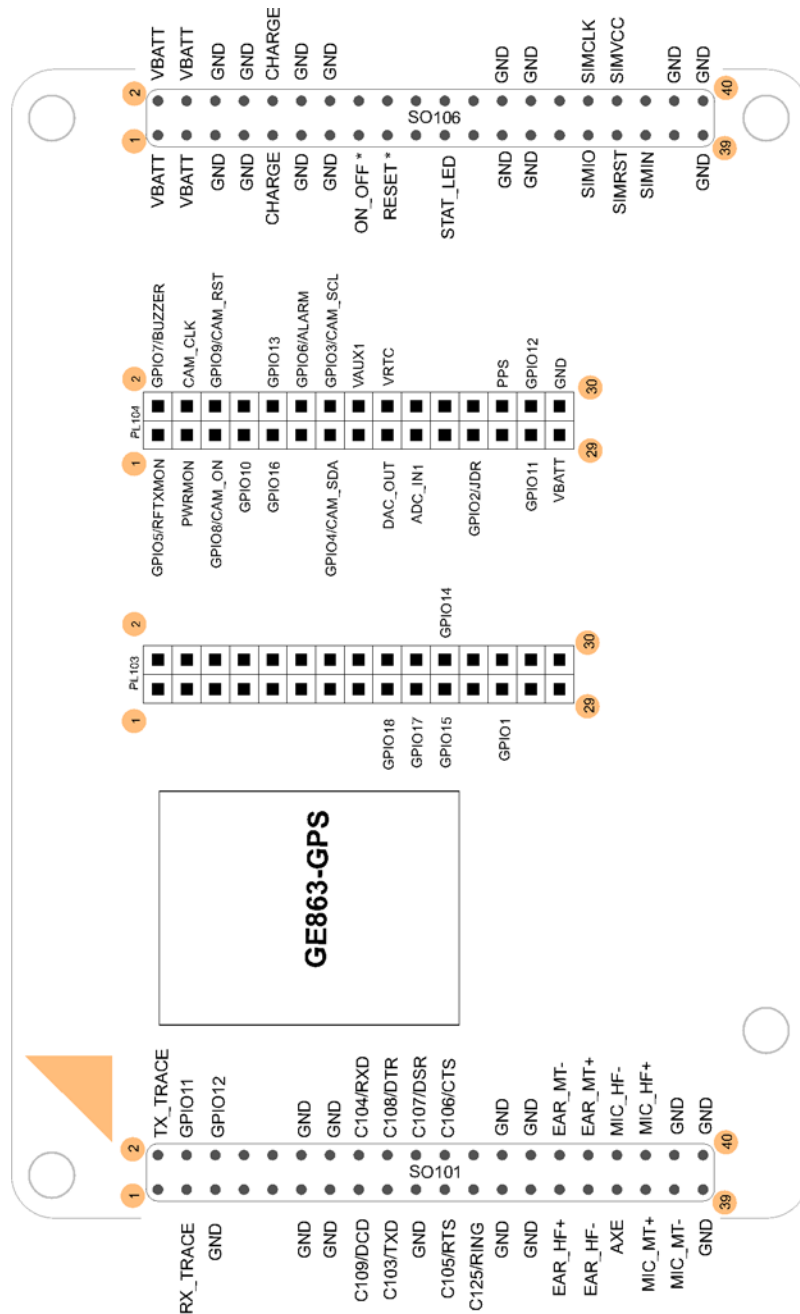

Position of GPIO ports on GE863-GPS interface



Note on p/n 3990250684 and p/n 3990250685 GE863
(Refer to schematic diagrams *30276SE11151A-C*, *30276SE11151A-D*)

If you use these interfaces the following two pins of PL104 connector assume different functions, and precisely:

Pin 20 = ADC_IN2
Pin 21 = ADC_IN3
Pin 26 = N.C



42.1.3. GE863 Interfaces (p/n 3990250684 -3990250685-3990250703)

Refer to schematic diagrams 3\0276SE11151A-C; 30276SE11151A-D; 30276SE11151A-G

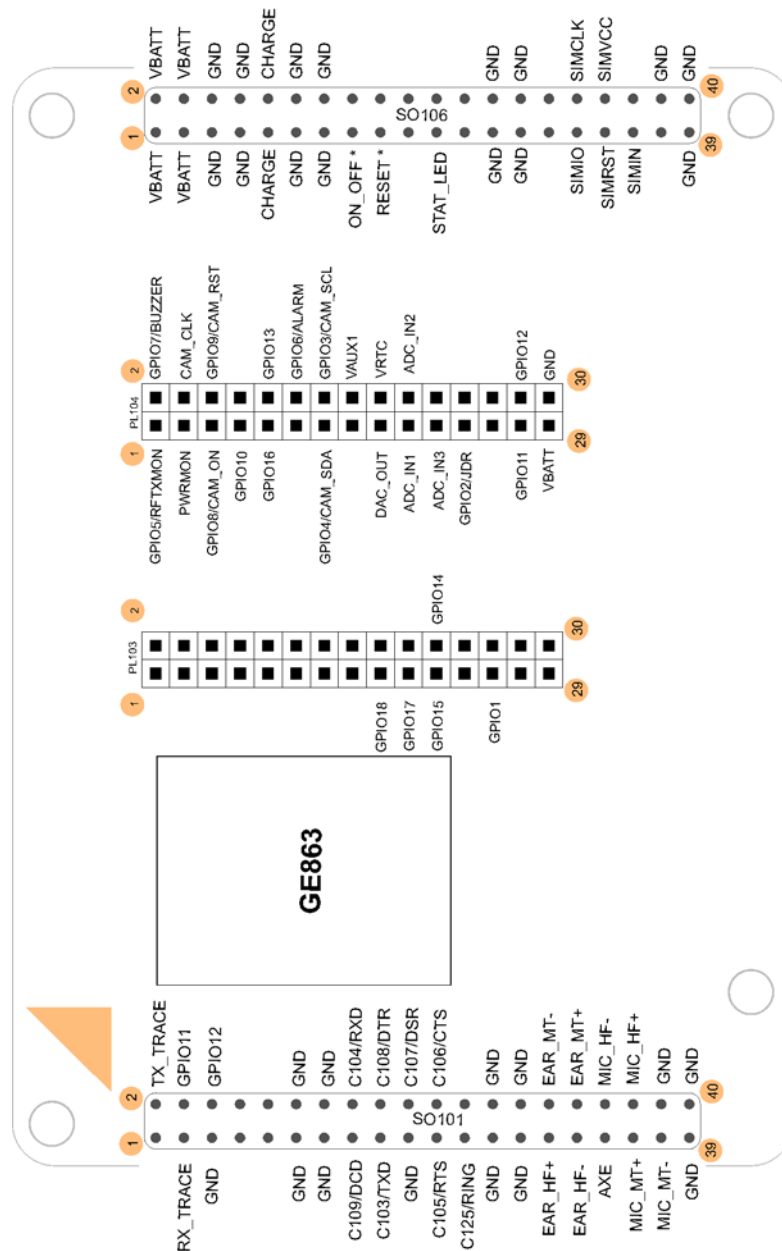

Position of GPIO ports on GE863 interfaces



42.1.4. GE864 Interface (p/n 3990250672)

(Refer to schematic diagram 30276SE1152B)

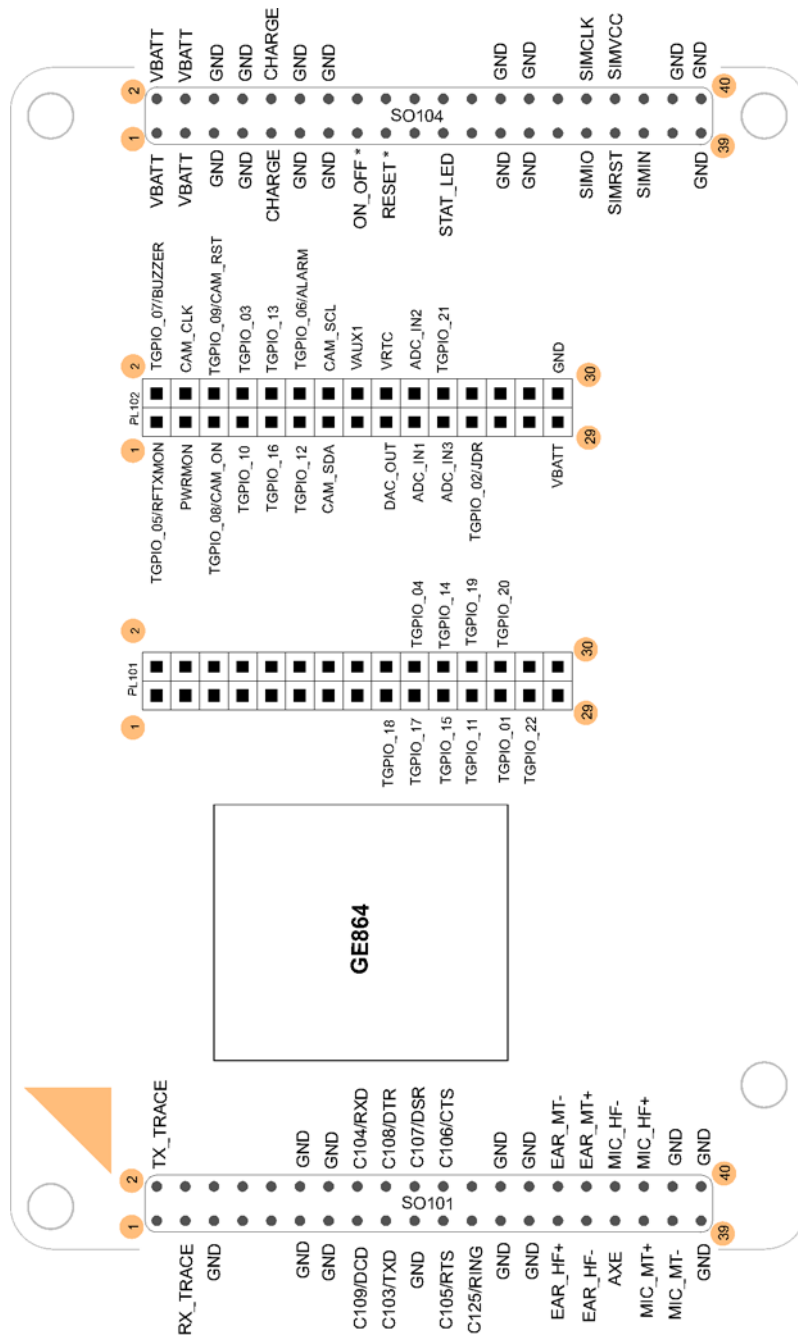

Position of GPIO ports on GE864 interface



42.1.5. GE864-GPS Interface (p/n 3990250822)

(Refer to schematic diagram 30373SE11439b)

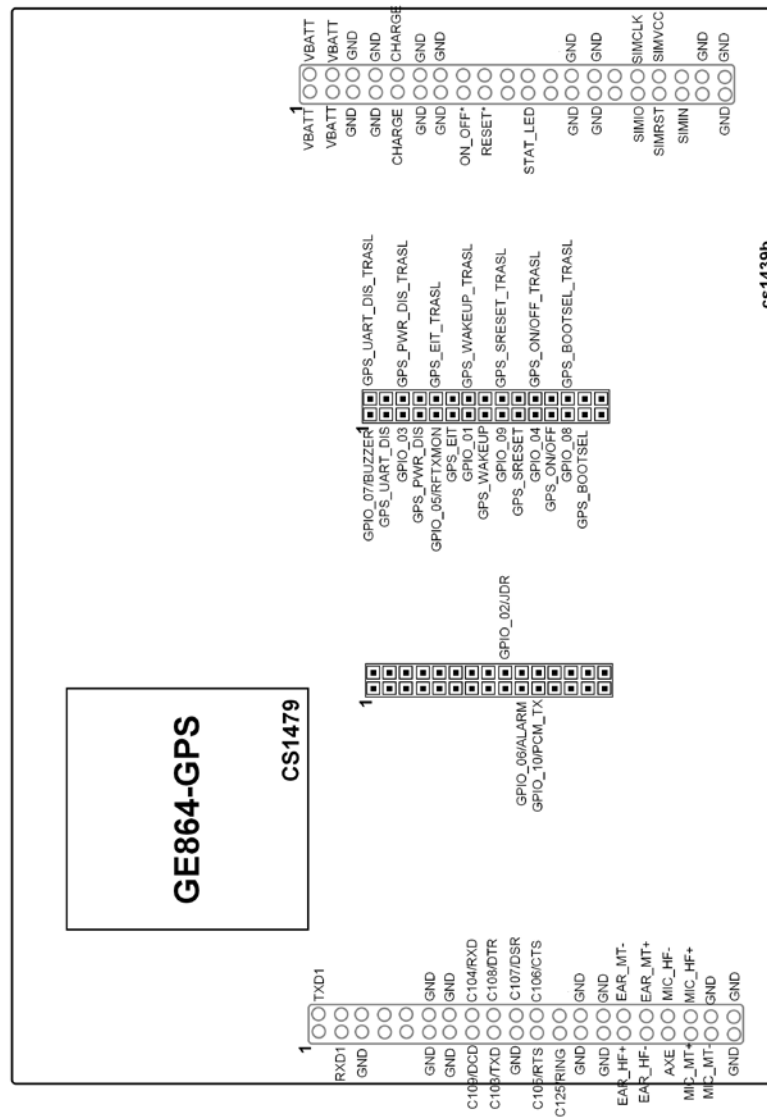

Position of GPIO ports on GE864-GPS interface



42.1.6. GE865/SE867-AGPS Interface (p/n 3990250814)

(Refer to schematic diagram 30311SE11433)

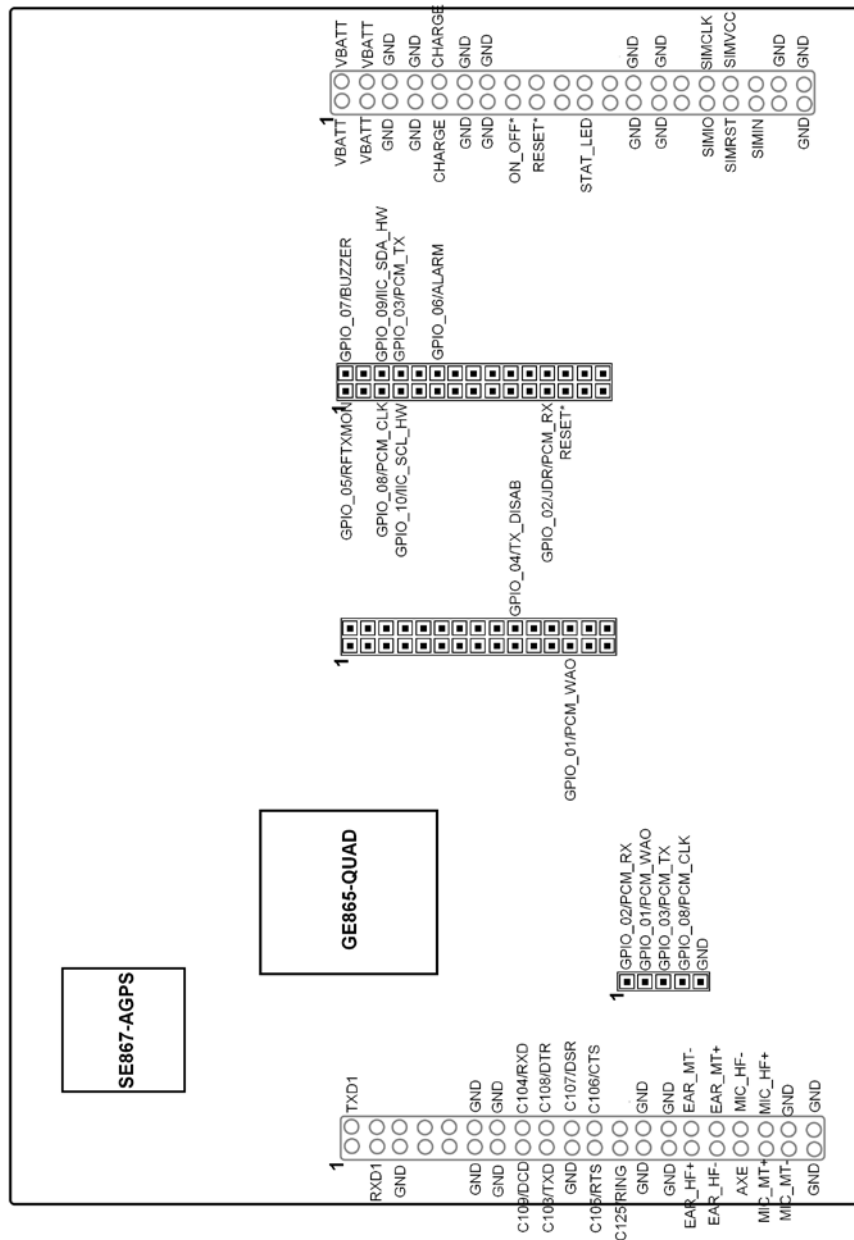

Position of GPIO ports on GE865/SE867-AGPS interface



42.1.7. GC864 Interface

(Refer to schematic diagram 30276SE111203B)

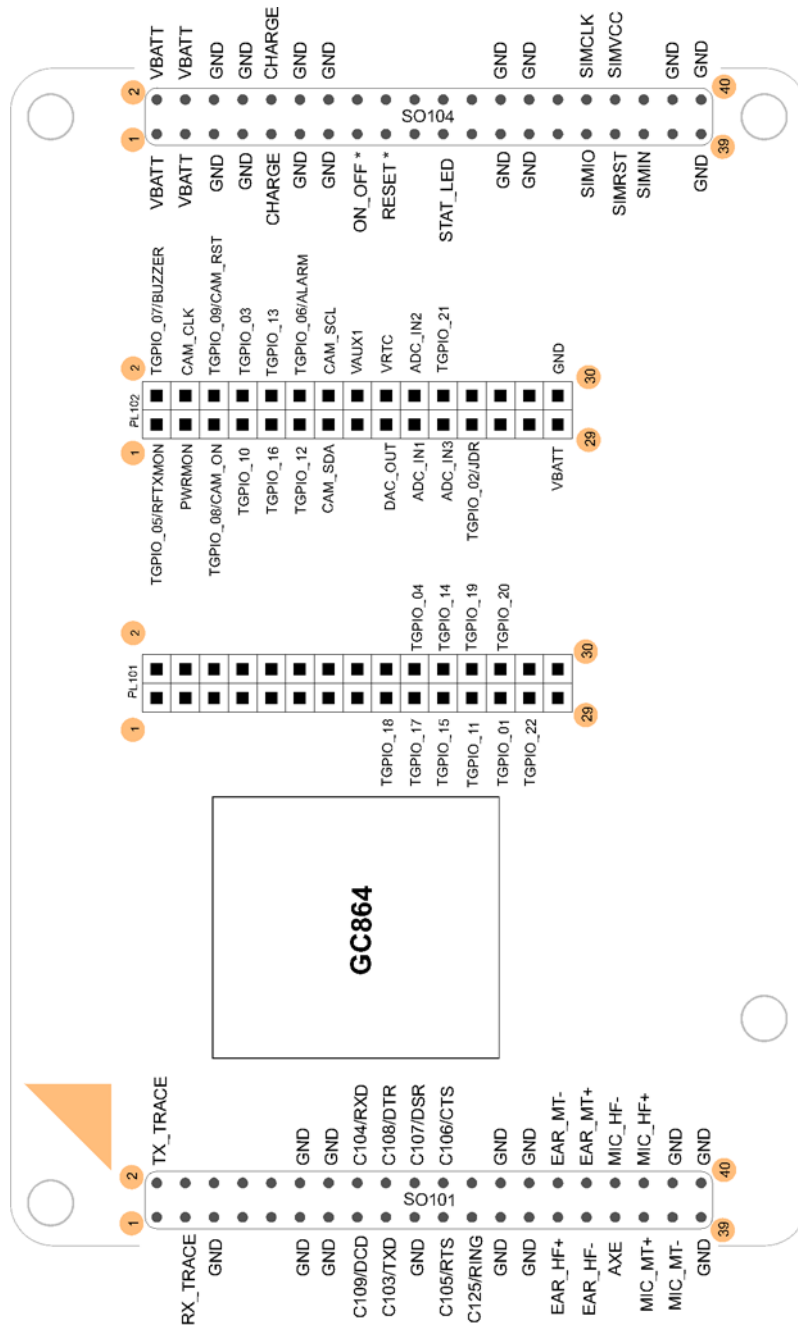

Position of GPIO ports on GC864 interface



42.1.8. GC864-C2 Interface (p/n 3990250683)

(Refer to schematic diagram 30276SE11231X)

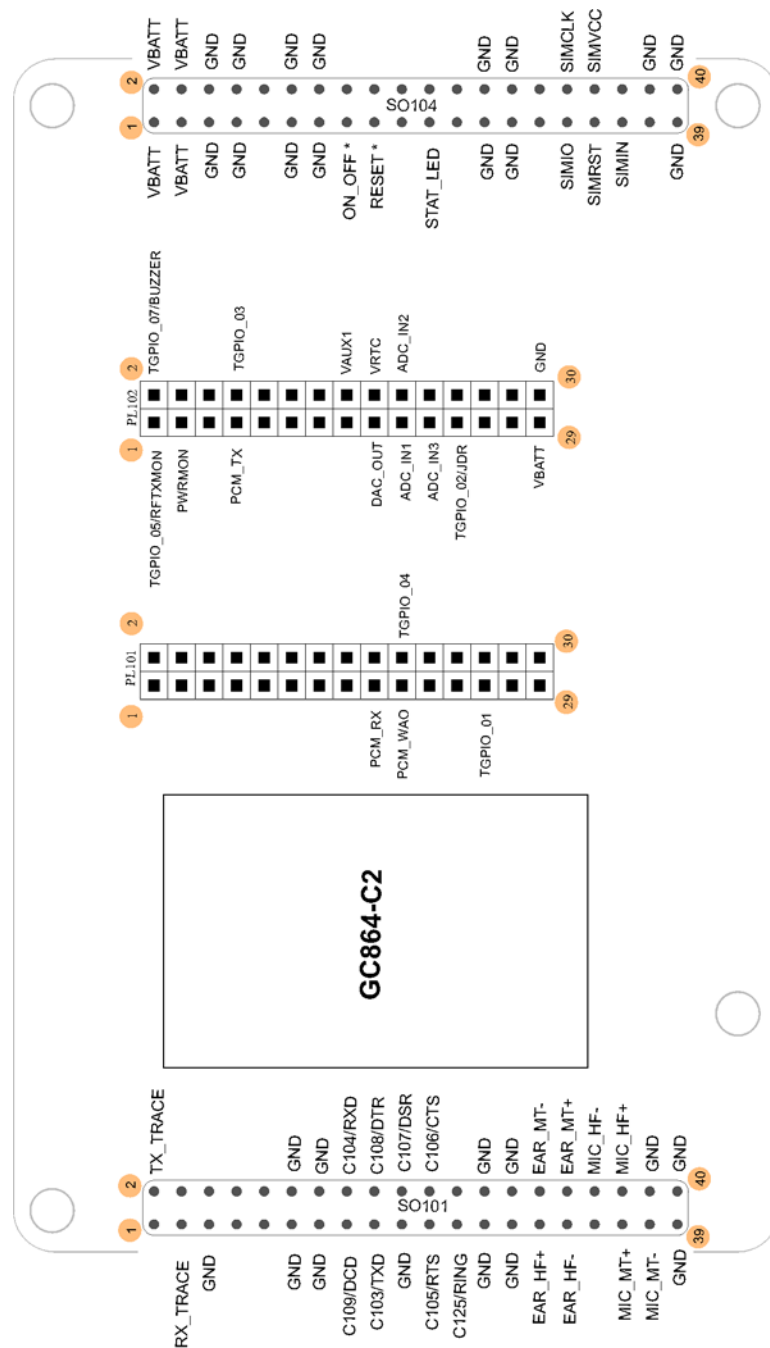

Position of GPIO ports on GC864-C2 interface



42.1.9. UC864 Interface

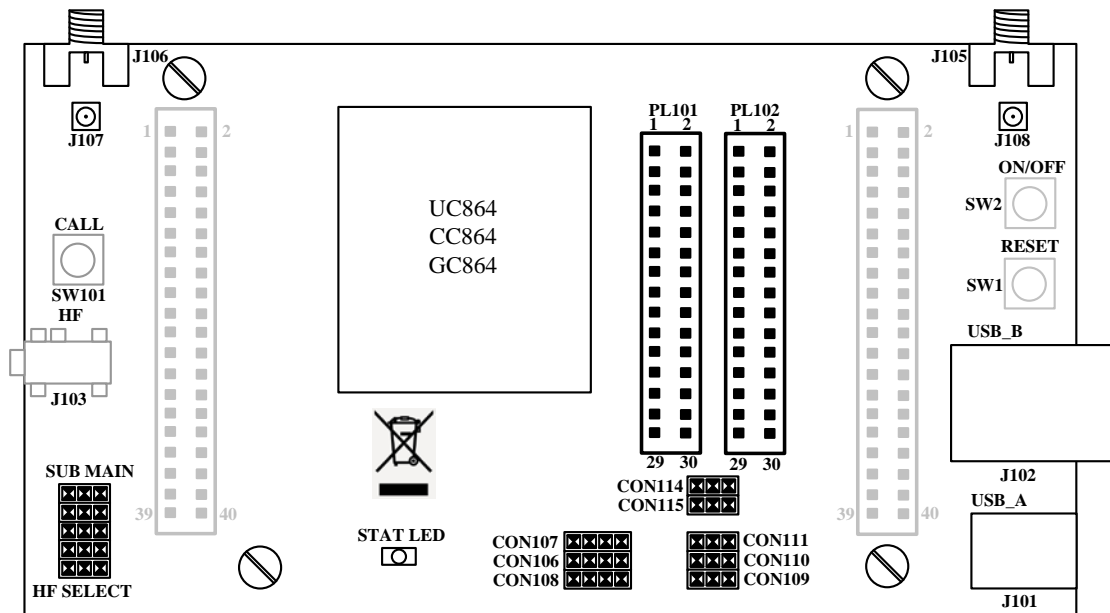

Position of GPIO on connectors of UC864 interface

PL101				PL102			
N.C	1	2	N.C	TGPIO_05/ RTXMON	1	2	TGPIO_07/ BUZZER
N.C	3	4	N.C	PWRMON	3	4	RESERVED
N.C	5	6	N.C	TGPIO_08	5	6	TGPIO_09
N.C	7	8	N.C	TGPIO_10/ PCM_TX	7	8	TGPIO_03
N.C	9	10	N.C	TGPIO_16	9	10	TGPIO_13
N.C	11	12	N.C	TGPIO_12	11	12	TGPIO_06/ ALARM
N.C	13	14	N.C	PCM_CLOCK	13	14	USB_ID
N.C	15	16	N.C	N.C.	15	16	VAUX1
TGPIO_18/ PCM_RX	17	18	N.C	DAC_OUT	17	18	VRTC
TGPIO_17/ PCM_SYNC	19	20	TGPIO_04	ADC_IN1	19	20	ADC_IN2
TGPIO_15	21	22	TGPIO_14	ADC_IN3	21	22	TGPIO_21
TGPIO_11	23	24	TGPIO_19	TGPIO_02/JDR	23	24	N.C
TGPIO_01	25	26	TGPIO_20	N.C	25	26	N.C
TGPIO_22	27	28	N.C	RESERVED	27	28	RESERVED
N.C	29	30	N.C	VBATT	29	30	GND

GPIO pin positioning



42.1.10. HE910 Interface

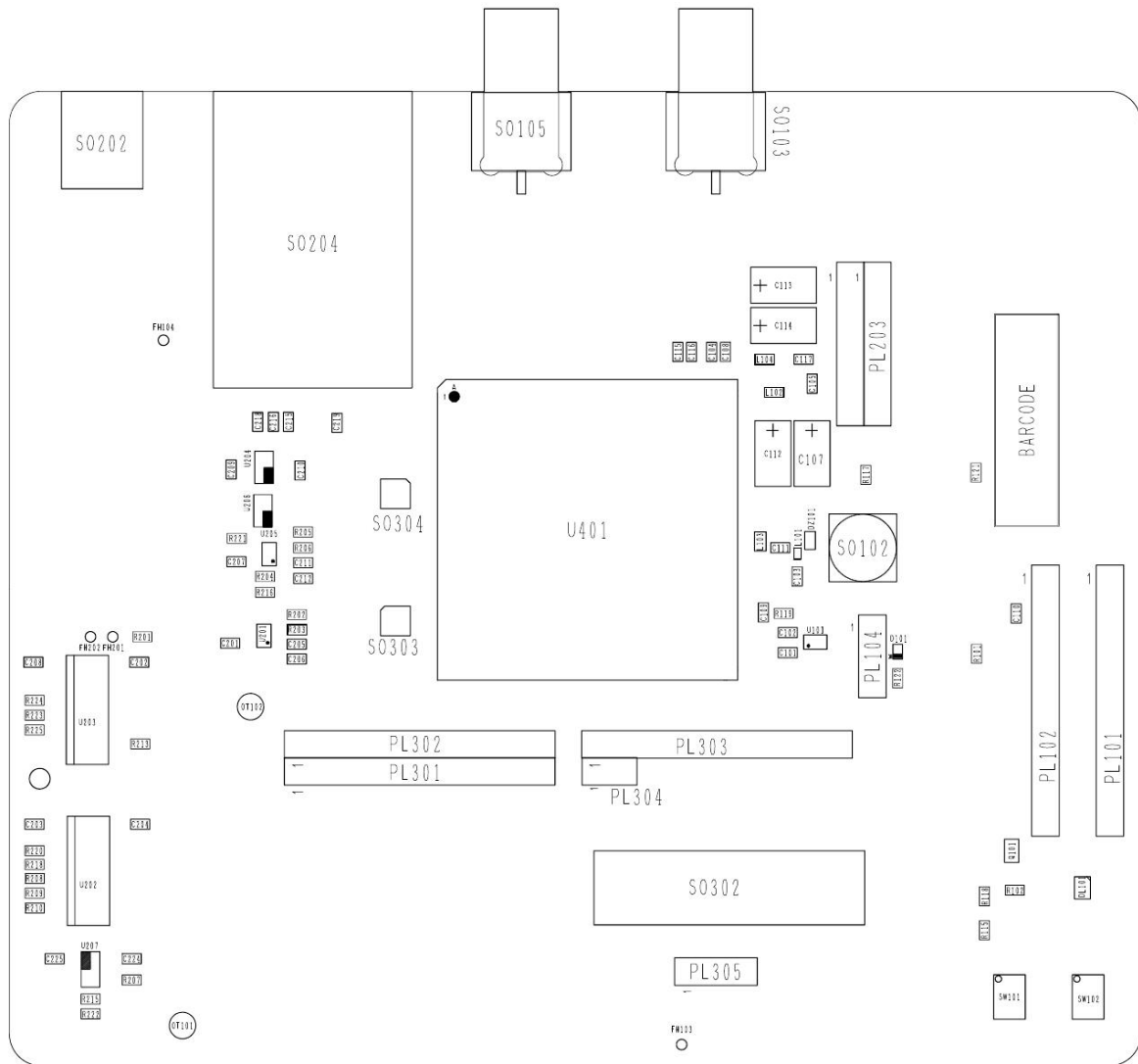

Position of GPIO on connectors of HE910 interface



42.1.11. GE910 Interface

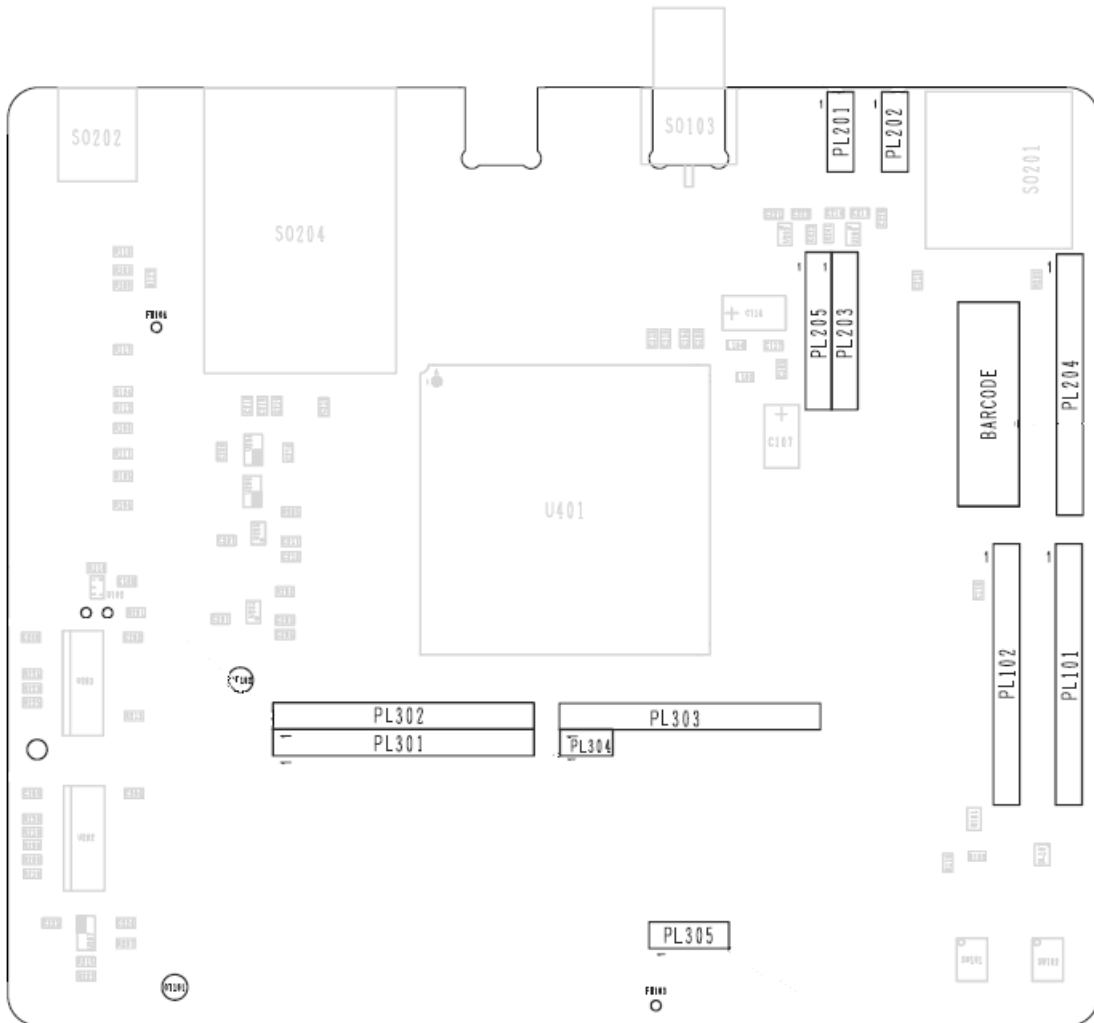

Position of GPIO on connectors of GE910 interface



The connectors are carrying the following signals:

Pin Name	Pin/Connector
GPIO_01	Pin 1 (PL302)
GPIO_02	Pin 2 (PL302)
GPIO_03	Pin 3 (PL302)
GPIO_04	Pin 4 (PL302)
GPIO_05	Pin 6 (PL102)
GPIO_06	Pin 5 (PL302)
GPIO_07	Pin 6 (PL302)
GPIO_08	Pin 6 (PL303)
GPIO_09	Pin 7 (PL303)
GPIO_10	Pin 8 (PL303)

PL305		
Pin#	Pin Name	Description
1	-	Reserved
2	VDD_IO	Input pin for the bus supply
3	VIO_1V8	VIO supply at 1.8V



42.1.12. DE910 Interface

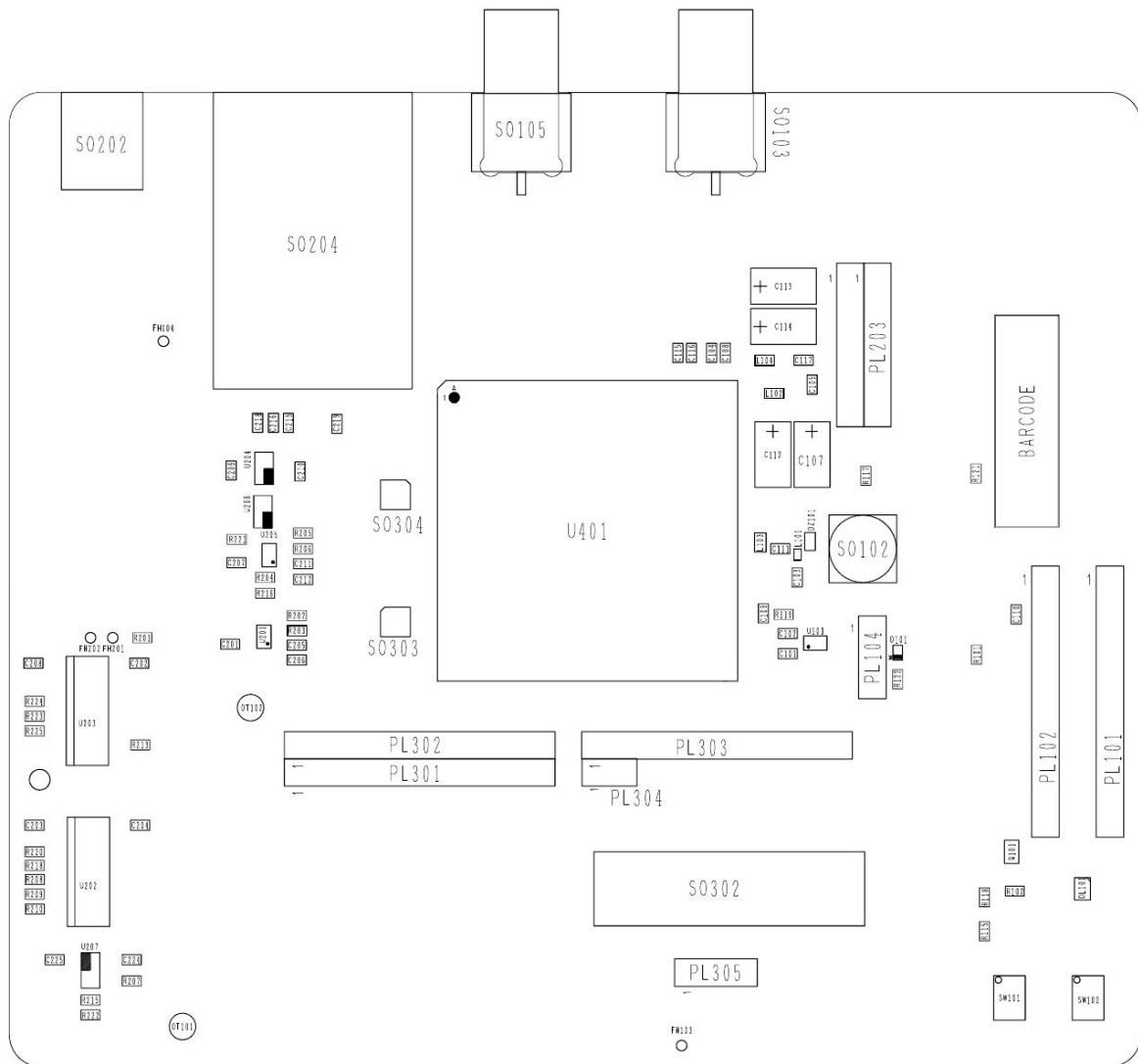

Position of GPIO on connectors of DE910 interface



The connectors are carrying the following signals:

Pin Name	Pin/Connector
GPIO_01	Pin 1 (PL302)
GPIO_02	Pin 2 (PL302)
GPIO_03	Pin 3 (PL302)
GPIO_04	Pin 4 (PL302)
GPIO_05	Pin 6 (PL102)
GPIO_06	Pin 5 (PL302)
GPIO_07	Pin 6 (PL302)
GPIO_08	Pin 6 (PL303)
GPIO_09	Pin 7 (PL303)
GPIO_10	Pin 8 (PL303)

PL305		
Pin#	Pin Name	Description
1	-	Reserved
2	VDD_IO	Input pin for the bus supply
3	VIO_1V8	VIO supply at 1.8V



42.1.13. CE910 Interface

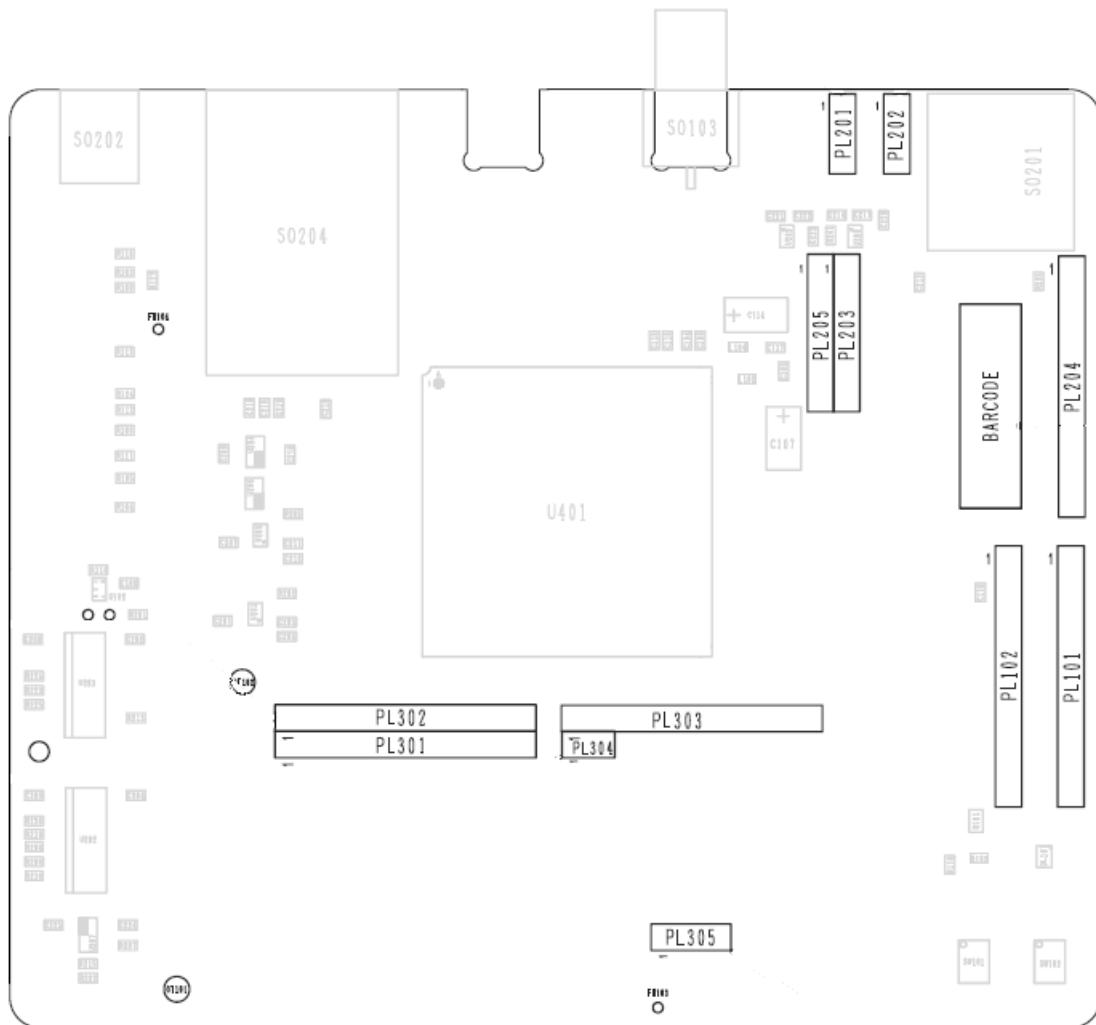

Position of GPIO on connectors of CE910 interface



The connectors are carrying the following signals:

Pin Name	Pin/Connector
GPIO_01	Pin 1 (PL302)
GPIO_02	Pin 2 (PL302)
GPIO_03	Pin 3 (PL302)
GPIO_04	Pin 4 (PL302)
GPIO_05	Pin 6 (PL102)
GPIO_06	Pin 5 (PL302)
GPIO_07	Pin 6 (PL302)
GPIO_08	Pin 6 (PL303)
GPIO_09	Pin 7 (PL303)
GPIO_10	Pin 8 (PL303)



42.1.14. GL865 V3 Interface

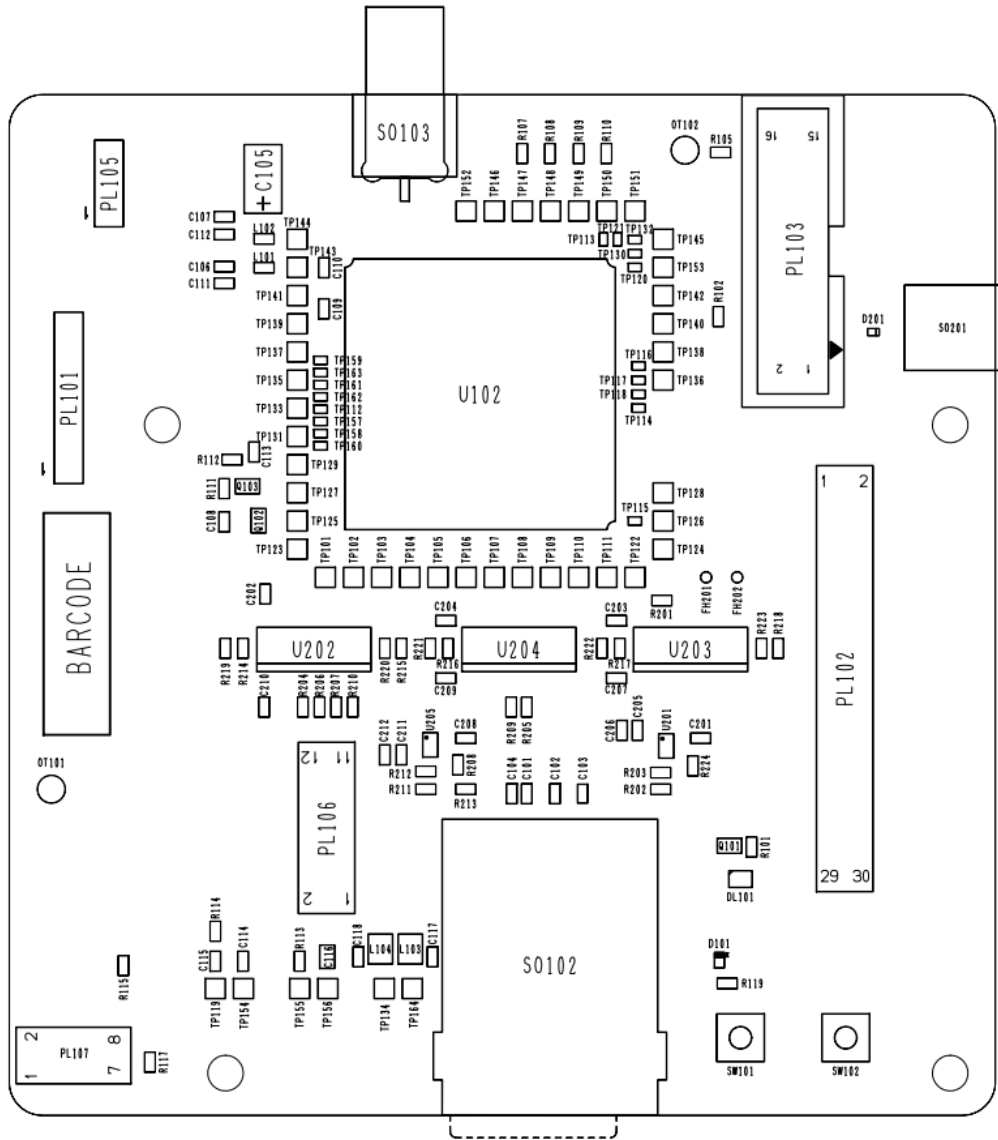

Position of GPIO on connectors of GL865 V3 interface



The connectors are carrying the following signals:

Pin Name	Pin/Connector
GPIO_01	Pin 6 (PL102) / Pin 4 (PL106)
GPIO_02	Pin 23 (PL102) / Pin 2 (PL106)
GPIO_03	Pin 8 (PL102) / Pin 6 (PL106)
GPIO_04	Pin 7 (PL102) / Pin 8 (PL106)
GPIO_05	Pin 1 (PL102)
GPIO_06	Pin 12 (PL102)
GPIO_07	Pin 2 (PL102) / Pin 7 (PL106) / Pin 3 (PL101)
GPIO_08	Pin 5 (PL102) / Pin 9 (PL106) / Pin 4 (PL101)



42.1.15. UL865 Interface

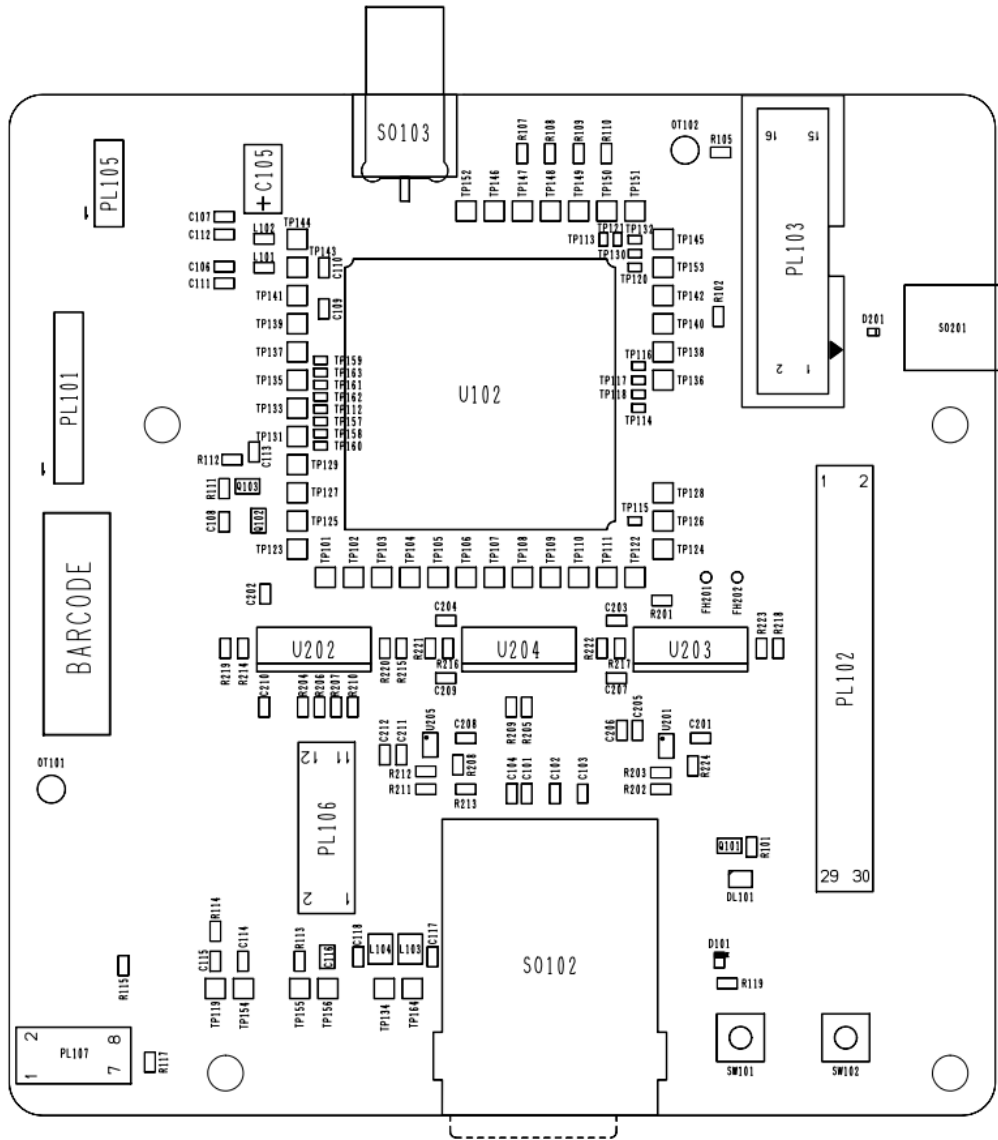

Position of GPIO on connectors of UL865 interface



The connectors are carrying the following signals:

Pin Name	Pin/Connector
GPIO_01	Pin 6 (PL102) / Pin 4 (PL106)
GPIO_02	Pin 23 (PL102) / Pin 2 (PL106)
GPIO_03	Pin 8 (PL102) / Pin 6 (PL106)
GPIO_04	Pin 7 (PL102) / Pin 8 (PL106)
GPIO_05	Pin 1 (PL102)
GPIO_06	Pin 12 (PL102)
GPIO_07	Pin 2 (PL102) / Pin 7 (PL106) / Pin 3 (PL101)
GPIO_08	Pin 5 (PL102) / Pin 9 (PL106) / Pin 4 (PL101)



42.1.16. HE920 Family Interface

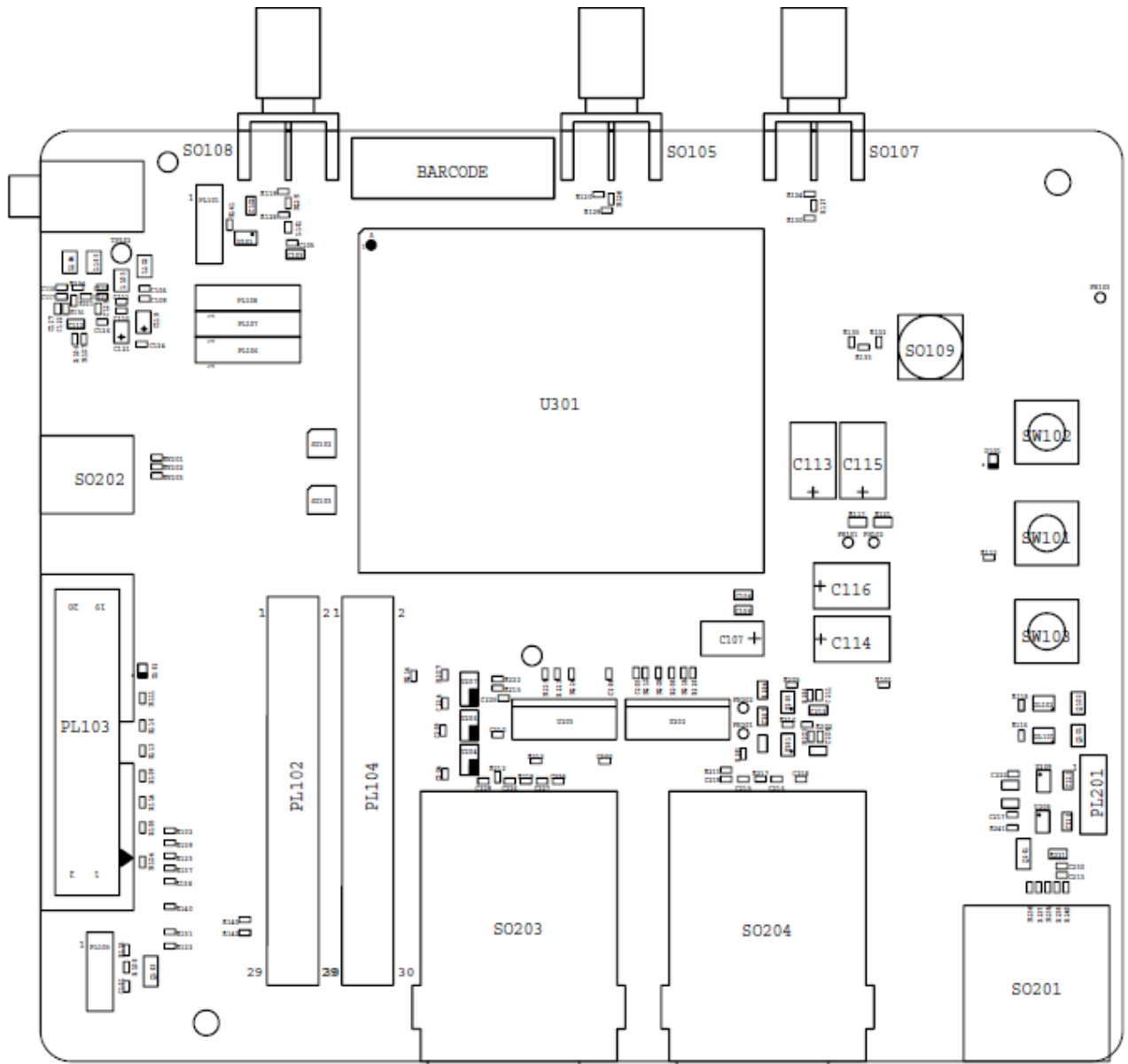

Position of GPIO on connectors of HE920 interface



The connectors are carrying the following signals:

Pin Name	Pin/Connector
GPIO_01	Pin 25 (PL102)
GPIO_02	Pin 23 (PL104)
GPIO_03	Pin 8 (PL104)
GPIO_04	Pin 20 (PL102)
GPIO_05	Pin 1 (PL104)
GPIO_06	Pin 12 (PL104)
GPIO_07	Pin 2 (PL104)
GPIO_08	Pin 5 (PL104)
GPIO_09	Pin 6 (PL104)
GPIO_10	Pin 7 (PL104)



42.1.17. HE910 V2 Interface

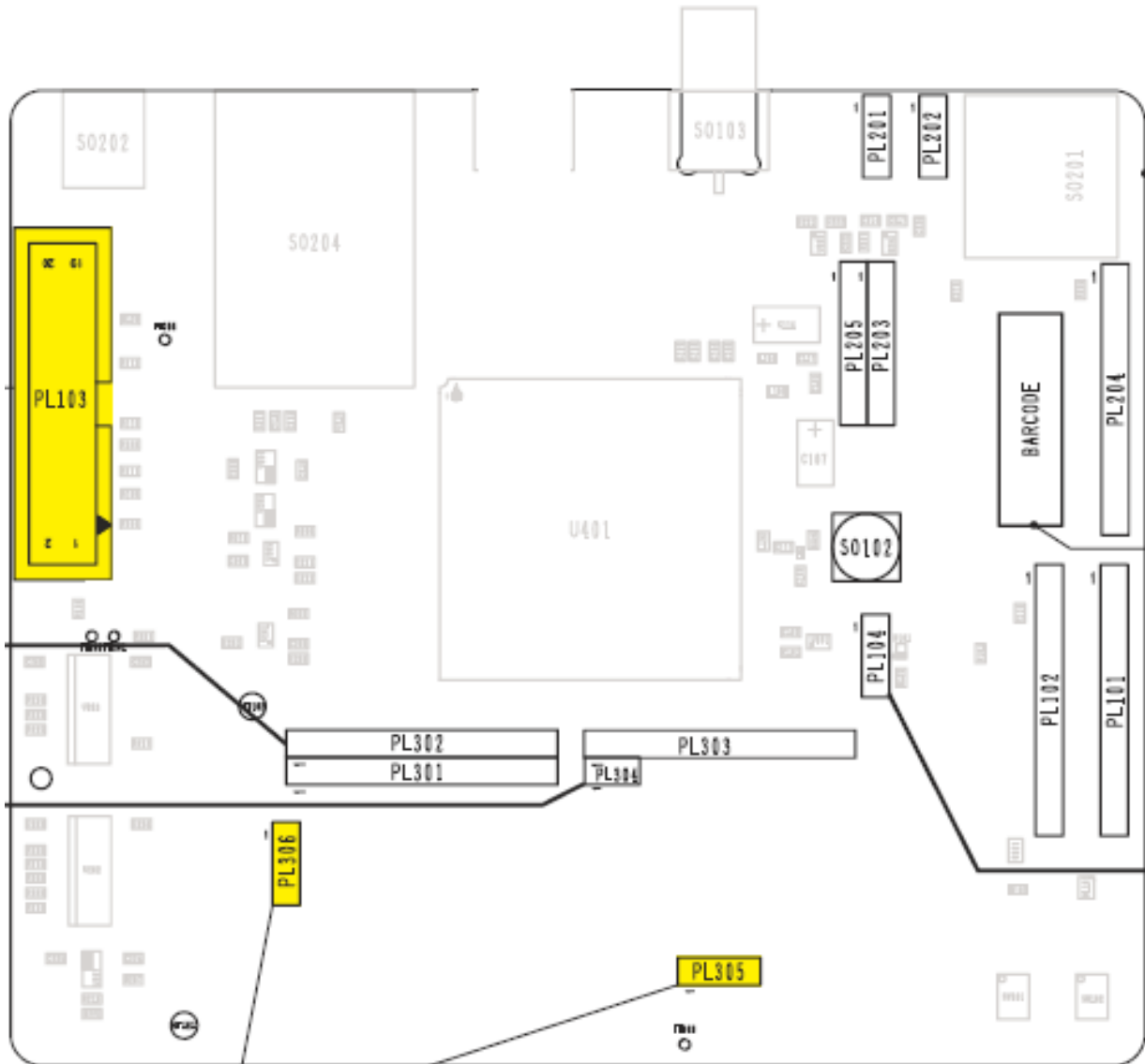

Position of GPIO on connectors of HE910 V2 interface



42.1.18. UE910 V2 Interface

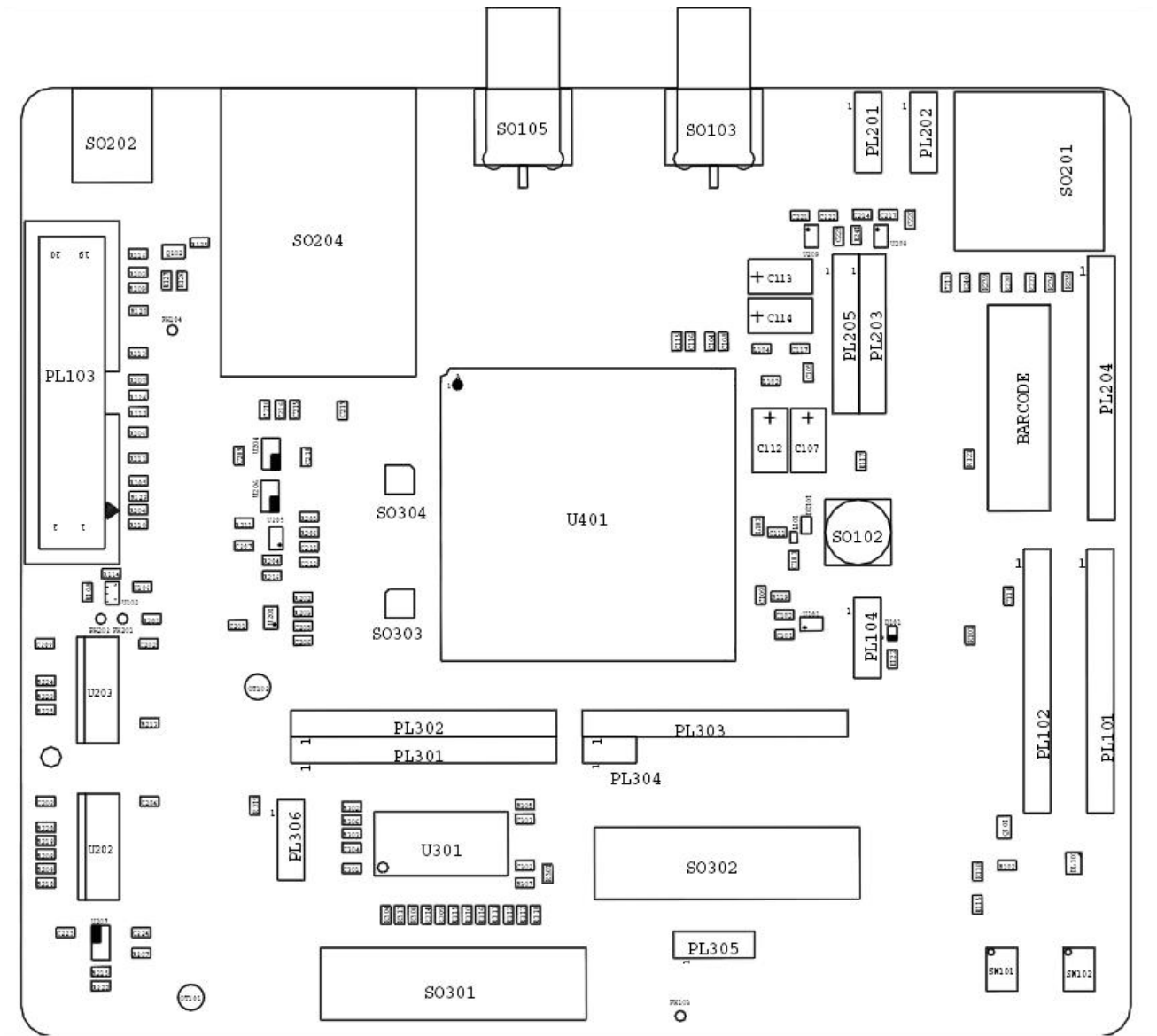

Position of GPIO on connectors of UE910 V2 interface



The connectors are carrying the following signals:

Pin Name	Pin/Connector
GPIO_01	Pin 1 (PL302)
GPIO_02	Pin 2 (PL302)
GPIO_03	Pin 3 (PL302)
GPIO_04	Pin 4 (PL302)
GPIO_05	Pin 6 (PL102)
GPIO_06	Pin 5 (PL302)
GPIO_07	Pin 6 (PL302)
GPIO_08	Pin 6 (PL303)
GPIO_09	Pin 7 (PL303)
GPIO_10	Pin 8 (PL303)

PL305		
Pin#	Pin Name	Description
1	-	Reserved
2	VDD_IO	Input pin for the bus supply
3	VIO_1V8	VIO supply at 1.8V



42.1.19. CL865 Interface

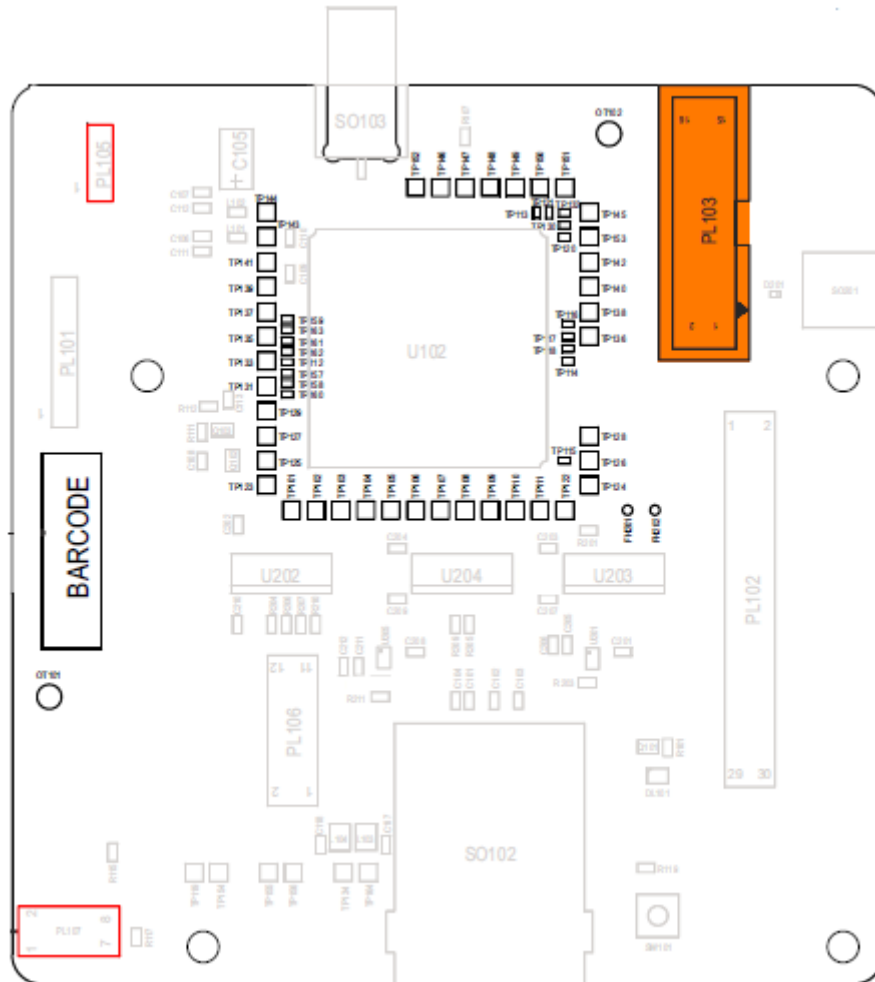

Position of GPIO on connectors of CL865 interface



42.1.20. GE866-QUAD Interface

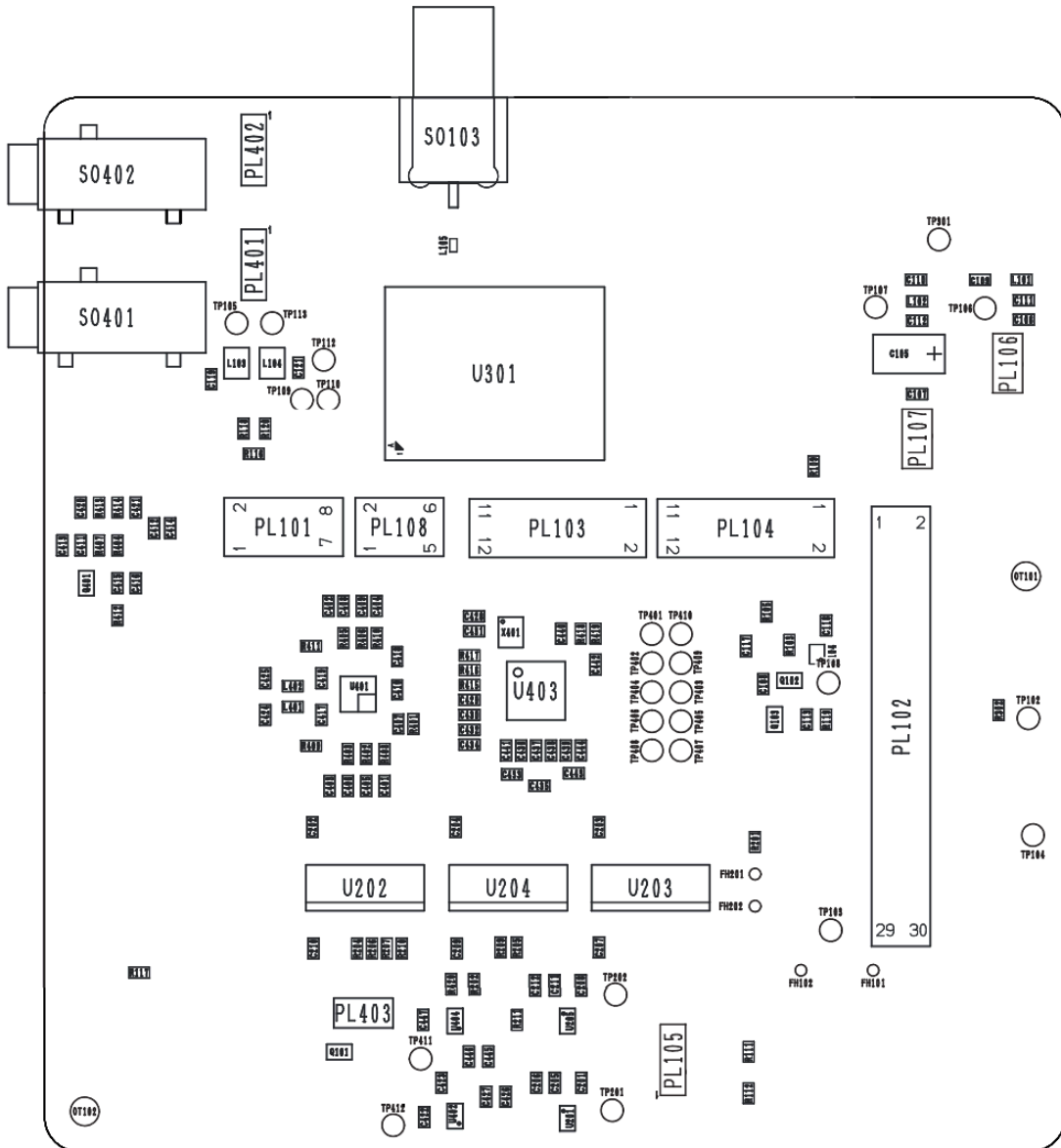

Layout of GE866-QUAD Interface



Pin Name	Pin/Connector
GPIO_01	Pin 6 (PL102) / Pin 3 (PL104)
GPIO_02	Pin 23 (PL102) / Pin 1 (PL104)
GPIO_03	Pin 8 (PL102) / Pin 5 (PL104)
GPIO_04	Pin 7 (PL102) / Pin 7 (PL104)
GPIO_05	Pin 1 (PL102)
GPIO_06	Pin 12 (PL102) / Pin 9 (PL104)
GPIO_07	Pin 5 (PL102) / Pin 11 (PL104)



42.1.21. LE910 Interface

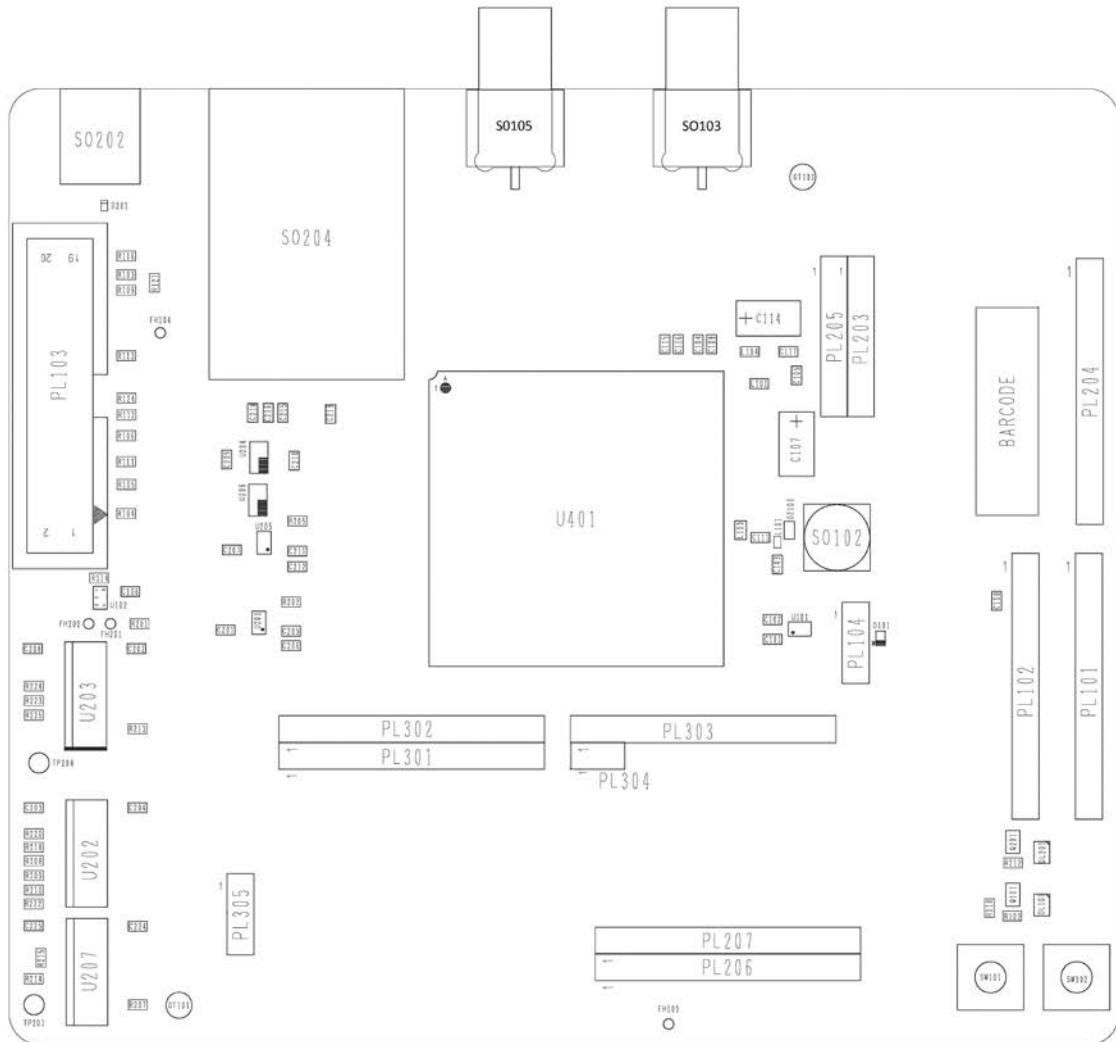

Position of GPIO on connectors of LE910 interface



The connectors are carrying the following signals:

Pin Name	Pin/Connector
GPIO_01	Pin 1 (PL302)
GPIO_02	Pin 2 (PL302)
GPIO_03	Pin 3 (PL302)
GPIO_04	Pin 4 (PL302)
GPIO_05	Pin 6 (PL102)
GPIO_06	Pin 5 (PL302)
GPIO_07	Pin 6 (PL302)
GPIO_08	Pin 6 (PL303)
GPIO_09	Pin 7 (PL303)
GPIO_10	Pin 8 (PL303)



43. SCHEMATICS

In the following paragraphs the user can find the schematics related to all EVK2 boards, therefore to the Mother Board, to the Interface Boards and to the Extension Boards.



43.1. EVK2 Mother Board

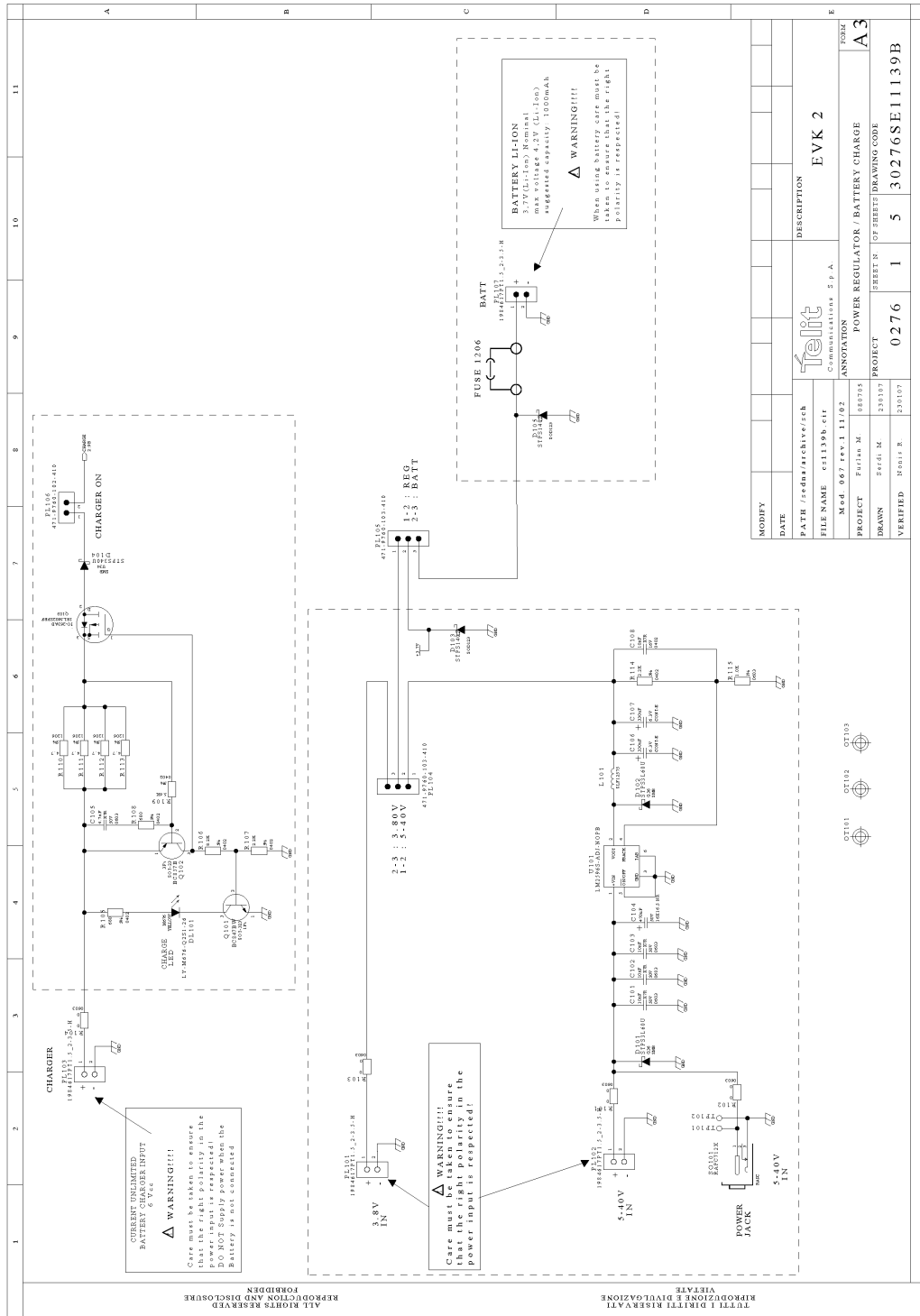

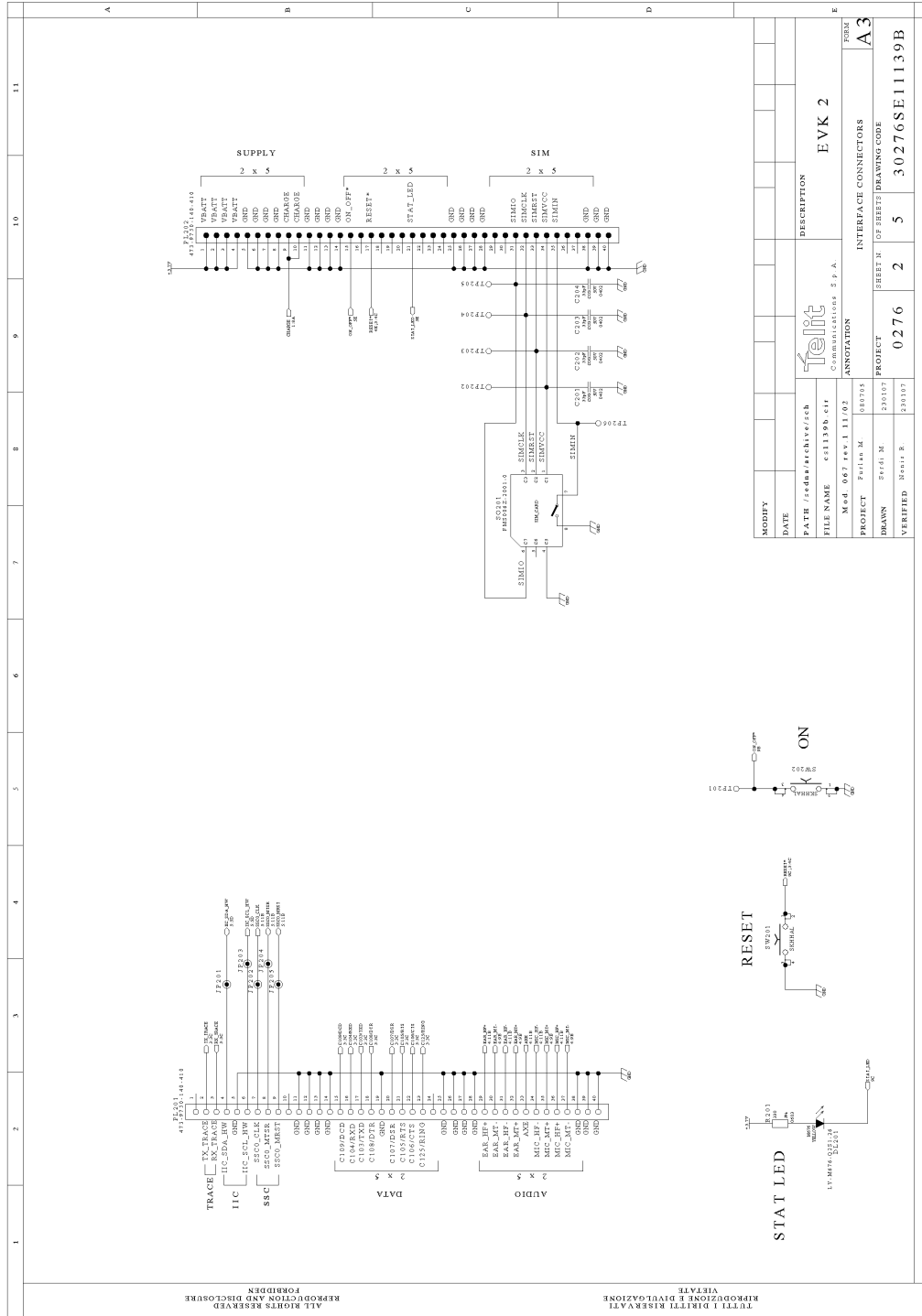

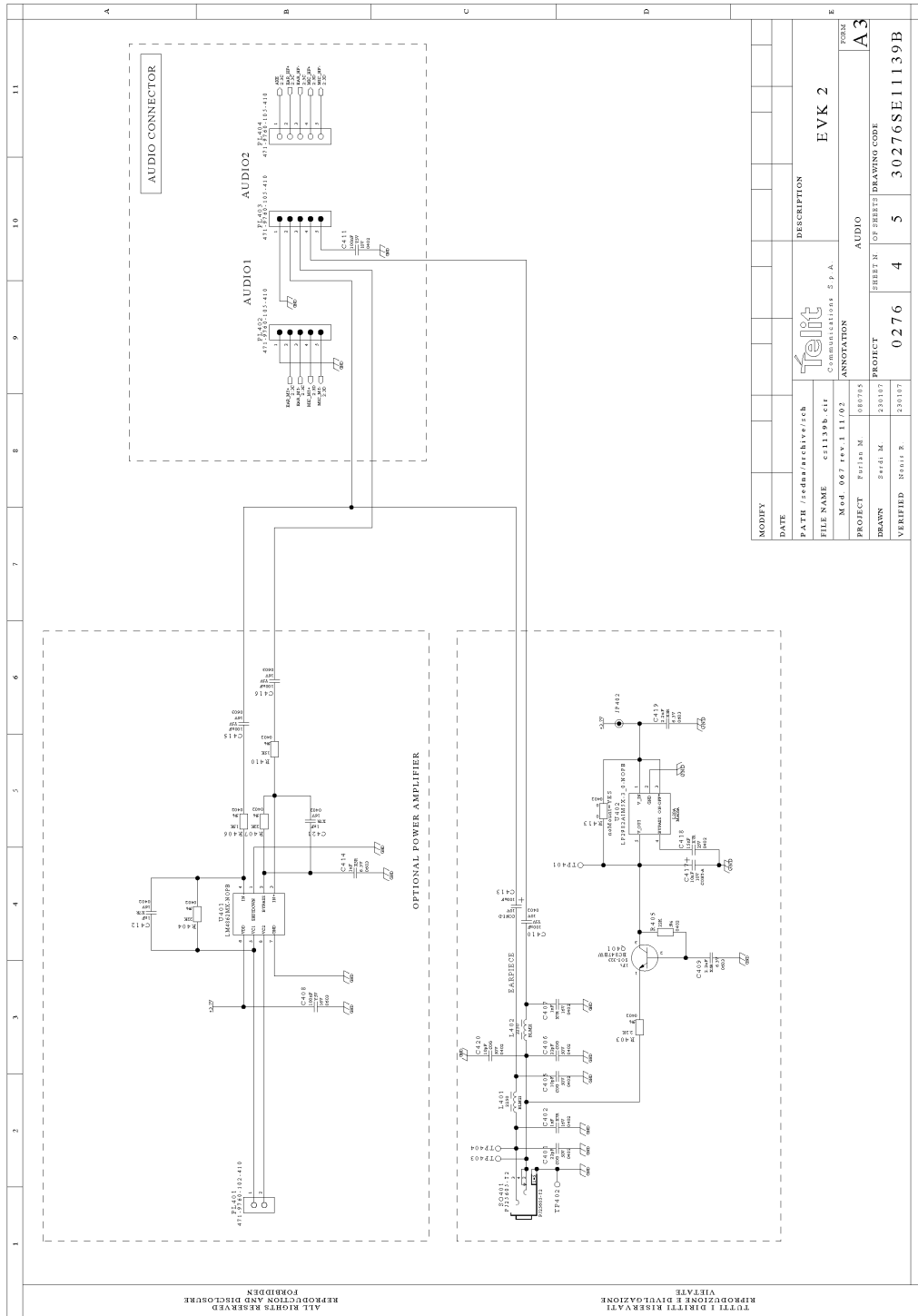

MODIFY	DATE	DESCRIPTION
		EVK 2

FILE NAME	evk139b.cir
Mod.	067 rev.1.11.02
PROJECT	Fullin M
DRAWN	Peri M
VERIFIED	Reali R

PROJECT	0276	SHEET N.	4	SHEET	5	DRAWING CODE	30276SE11139B
ANNOTATION	AUDIO						
FORN.	A3						



Telit EVK2 User Guide
1w0300704 Rev.18 – 2014/06/30

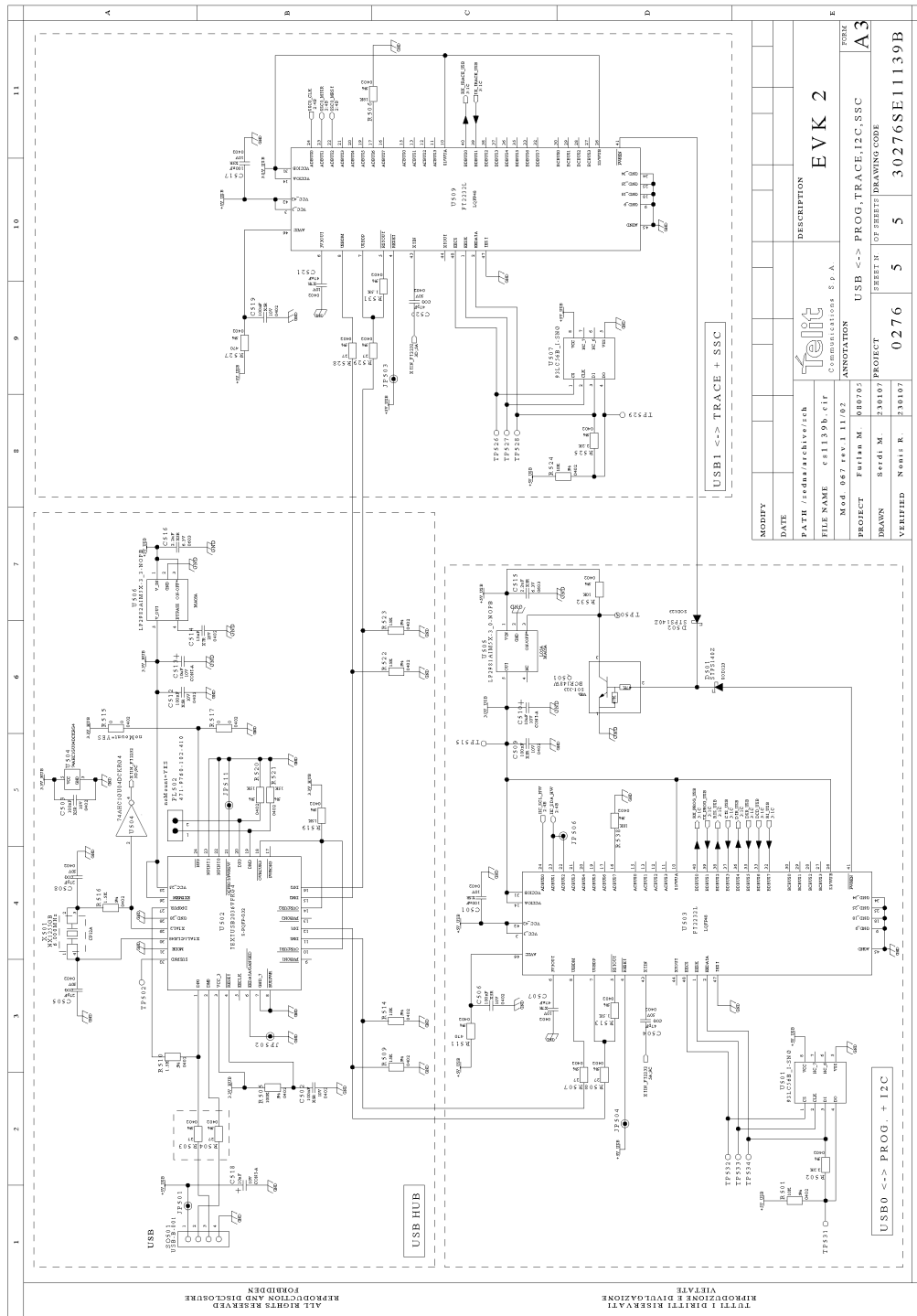

43.2. GM862 Interface Board

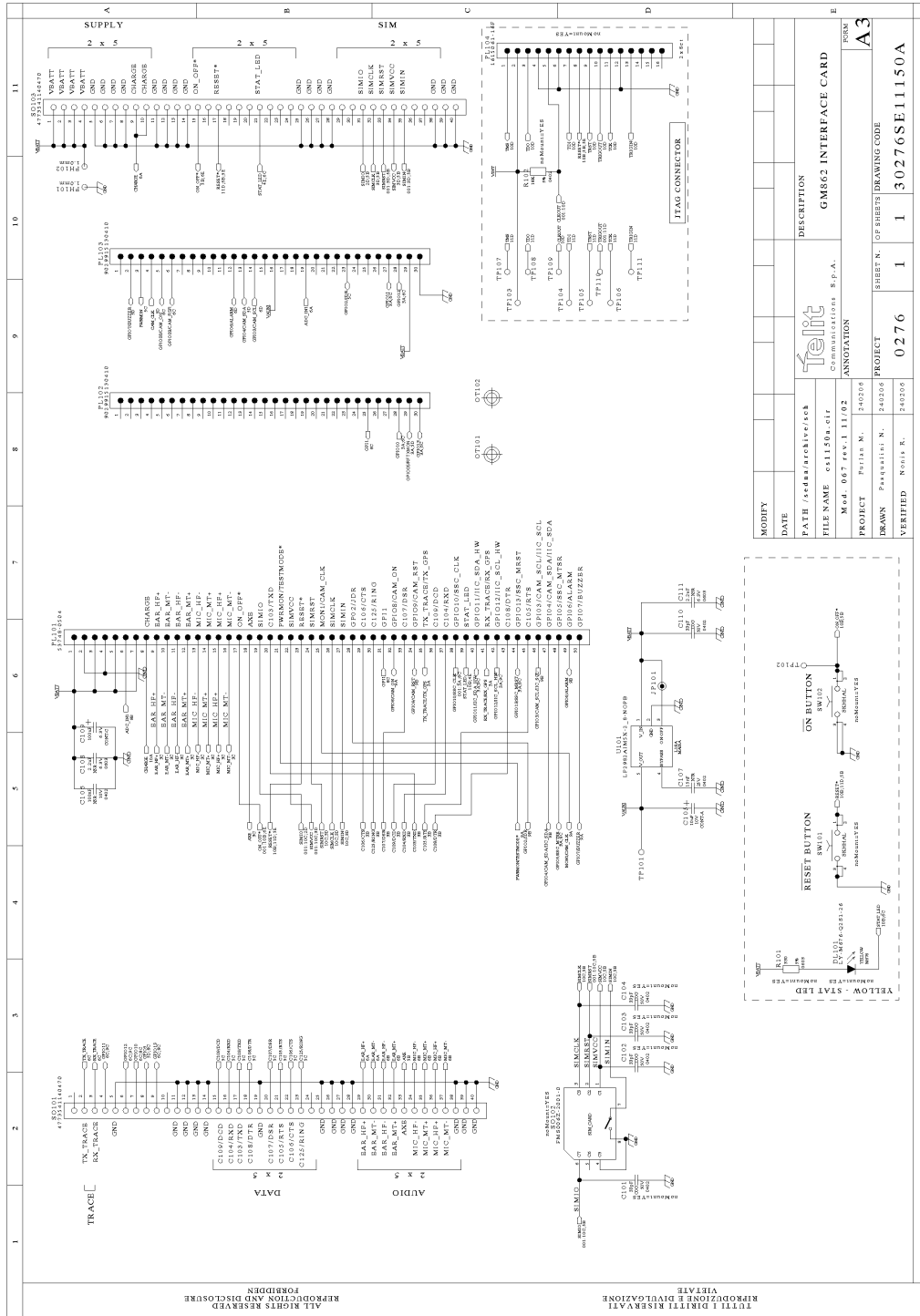

43.3. GE863 Interface Board

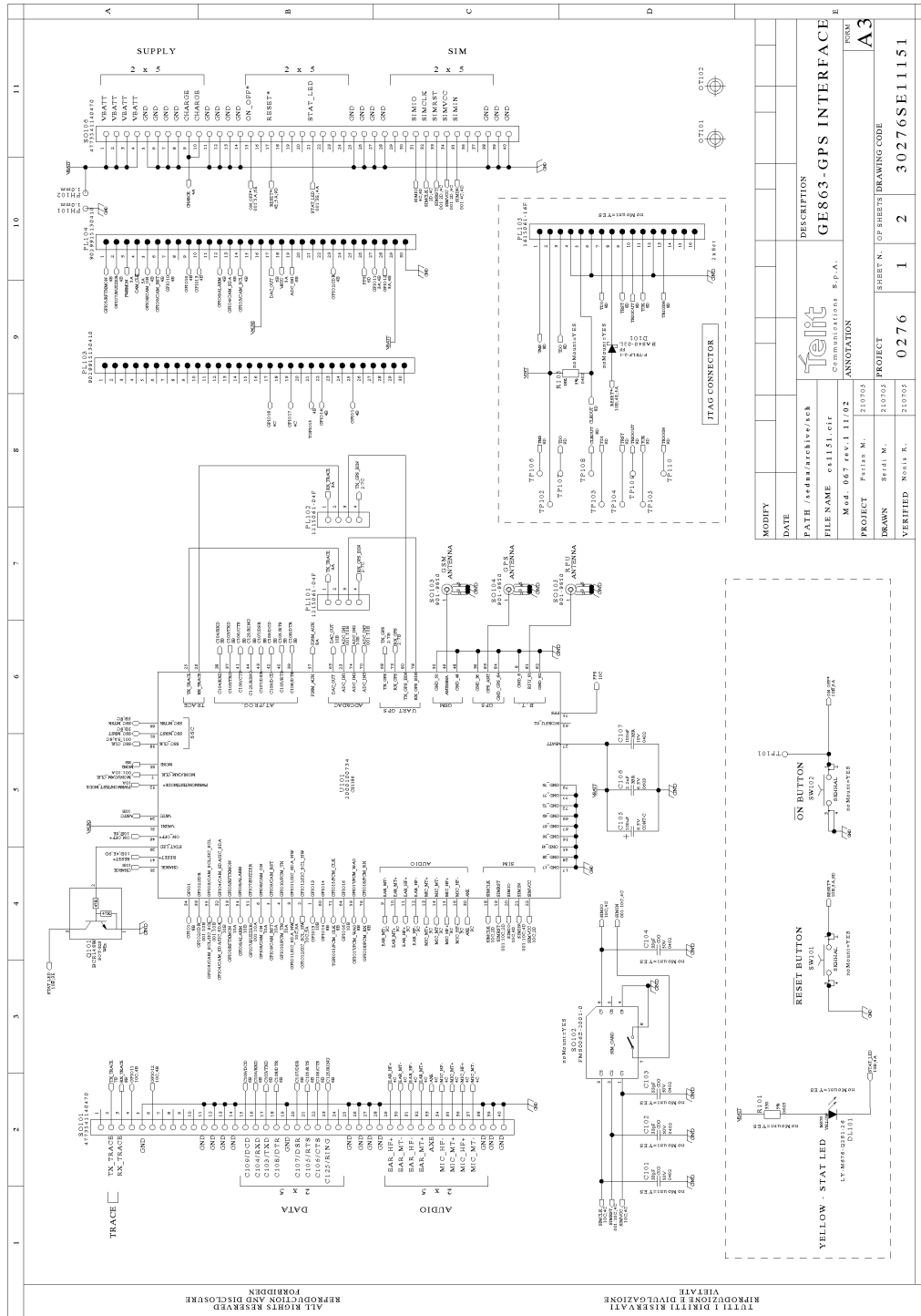

43.4. GE864 Interface board

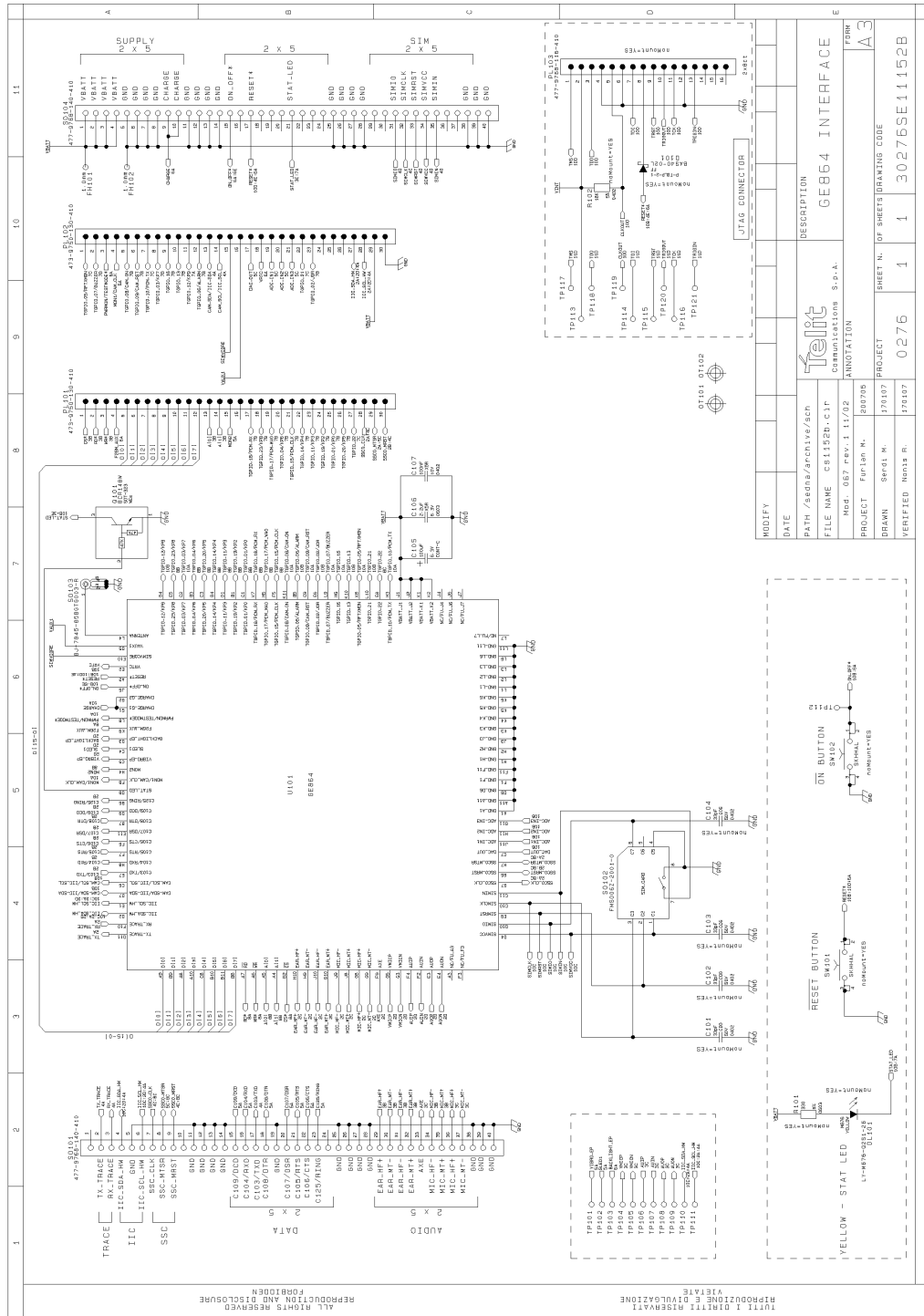

43.5. GE864 Interface board – Automotive

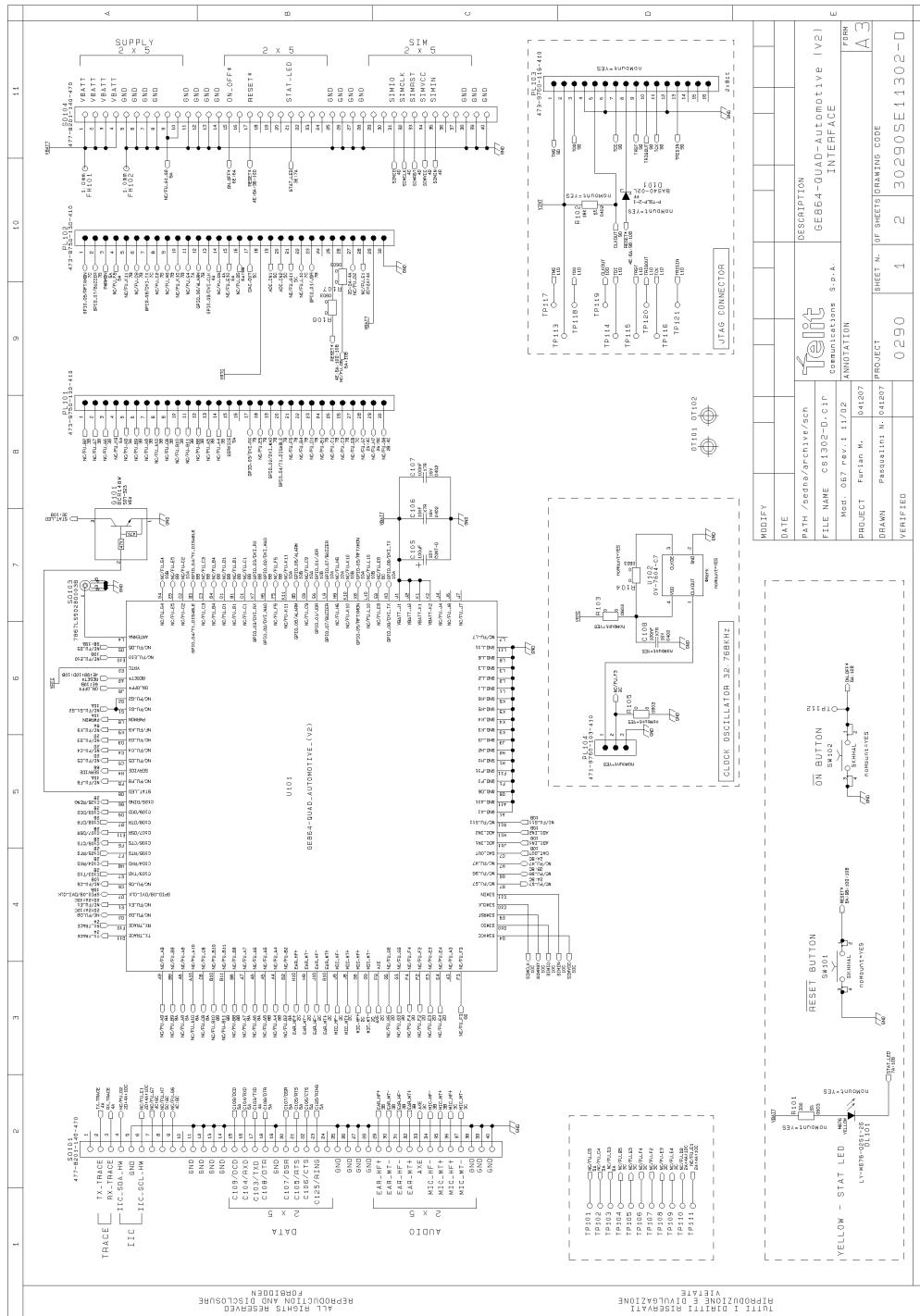

43.6. GE864 Interface board – V2

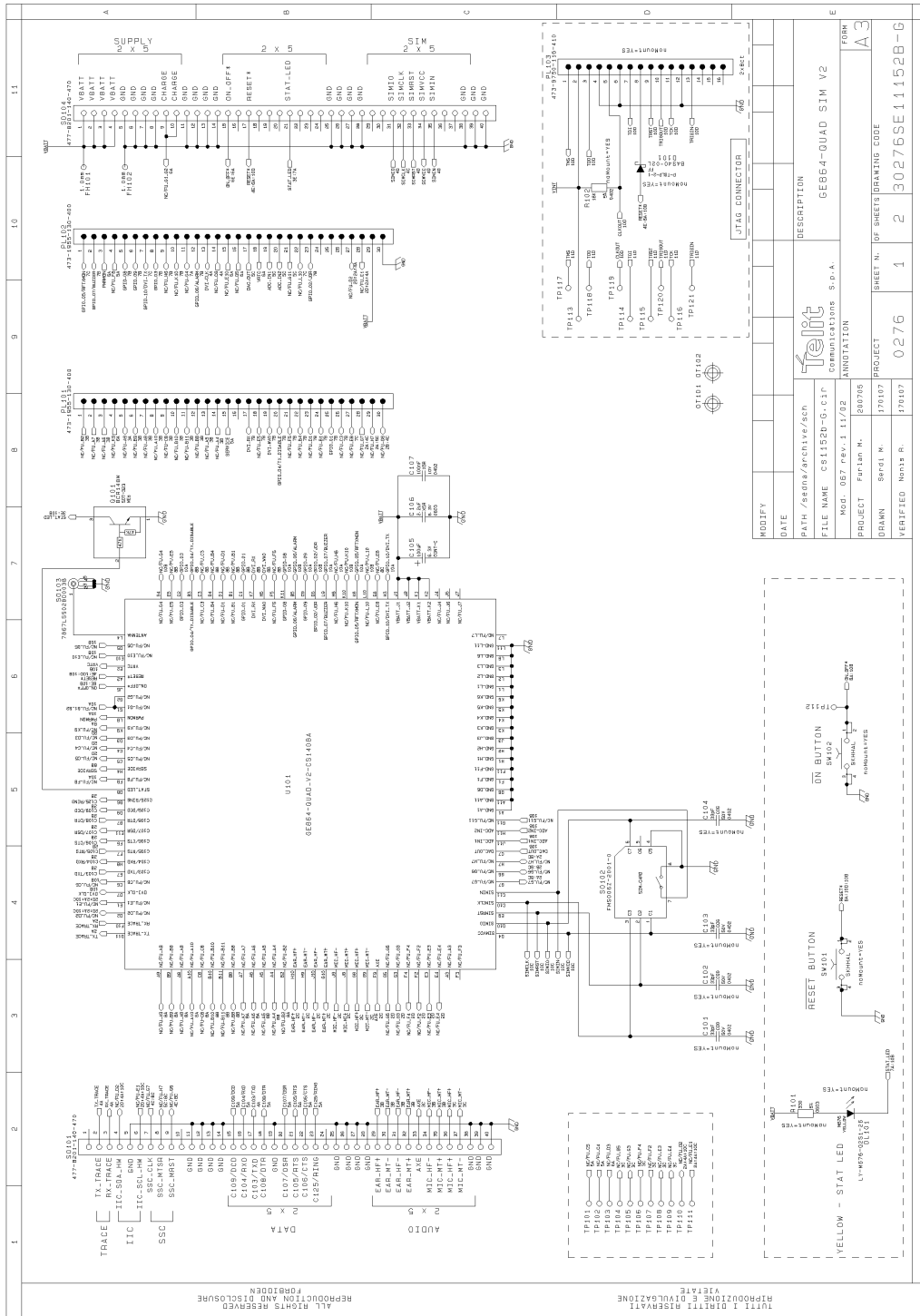

43.8. GE865/SE867-AGPS Interface board

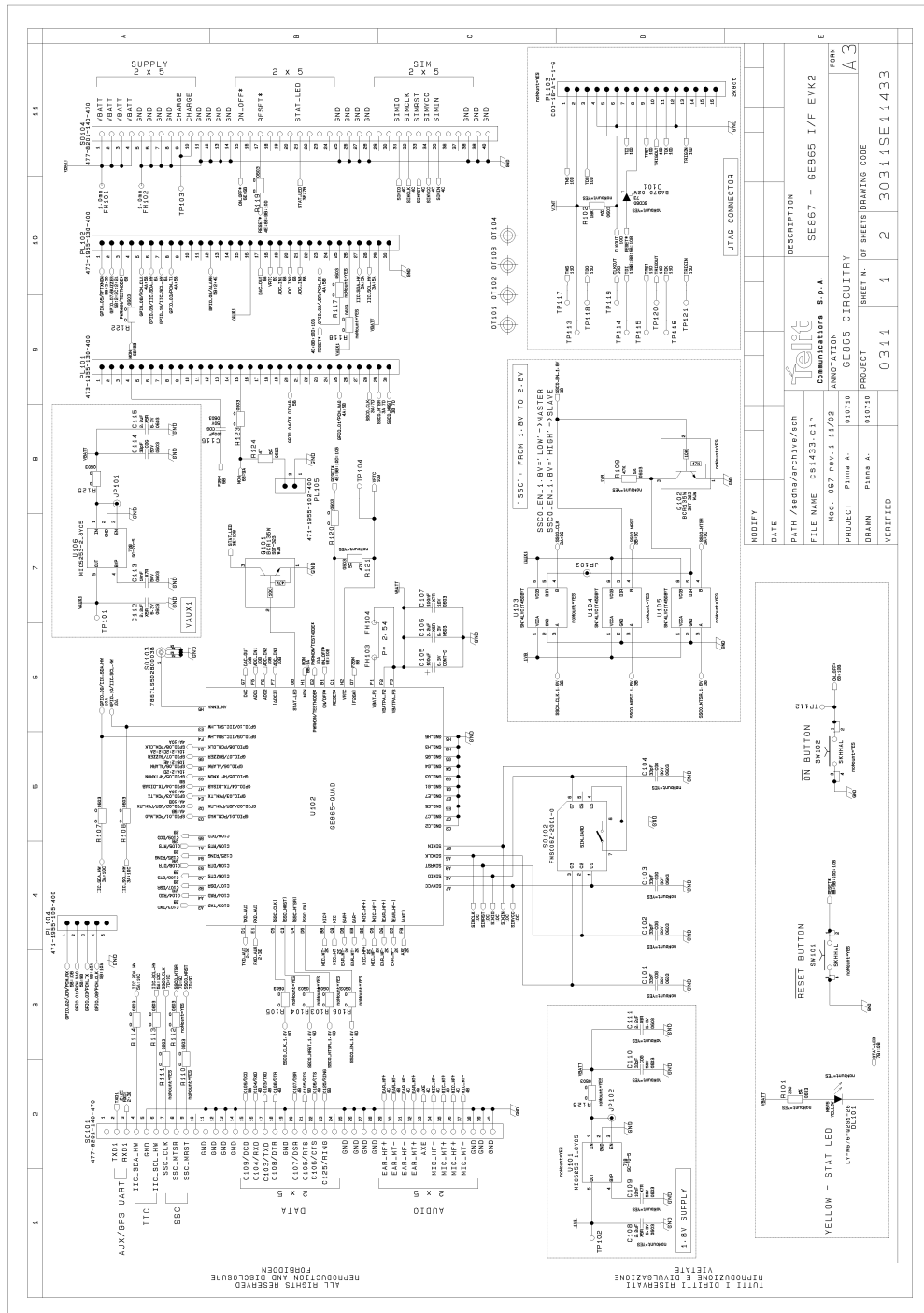

43.9. GE865 Interface board

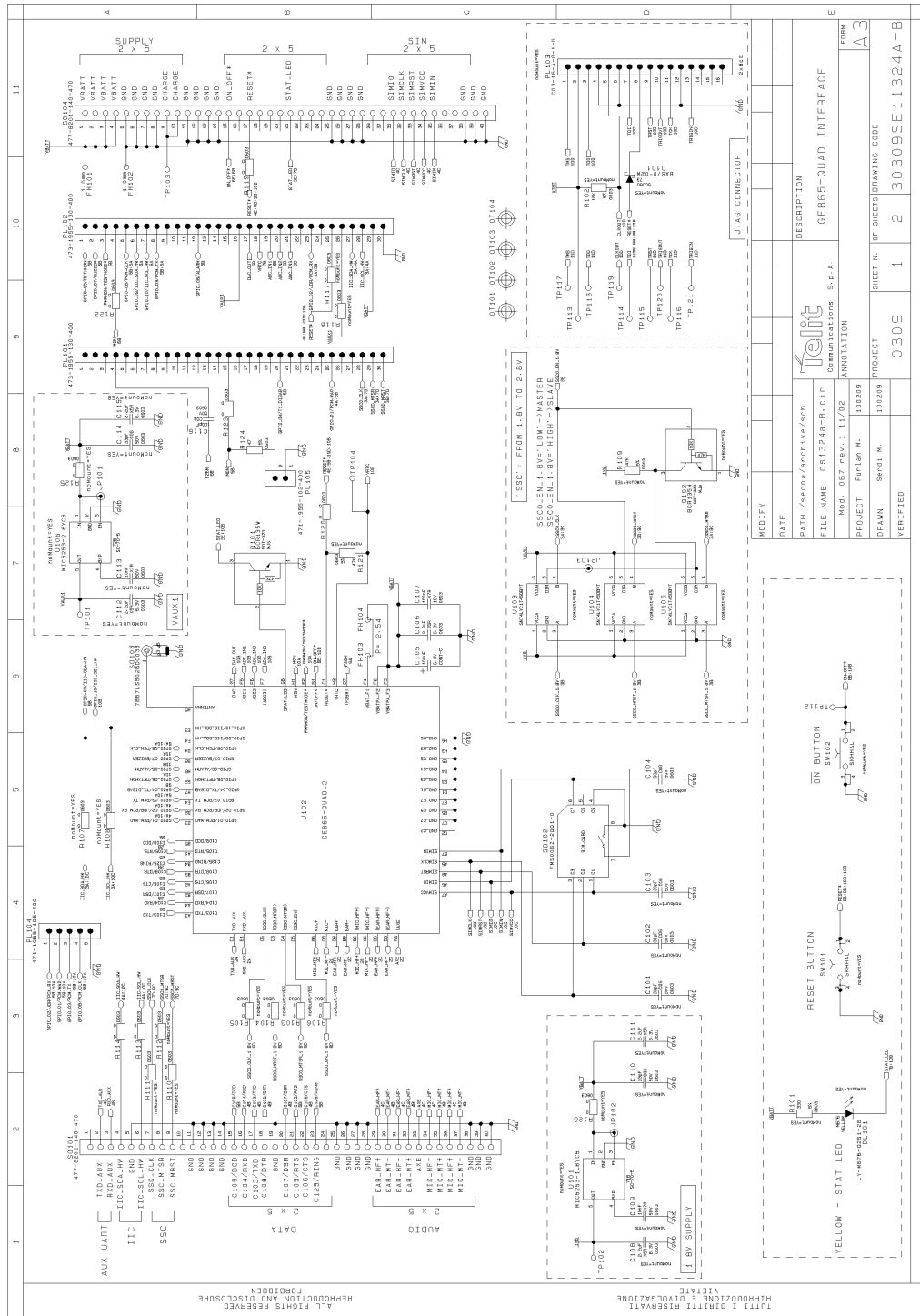

43.10. GL865 Interface board

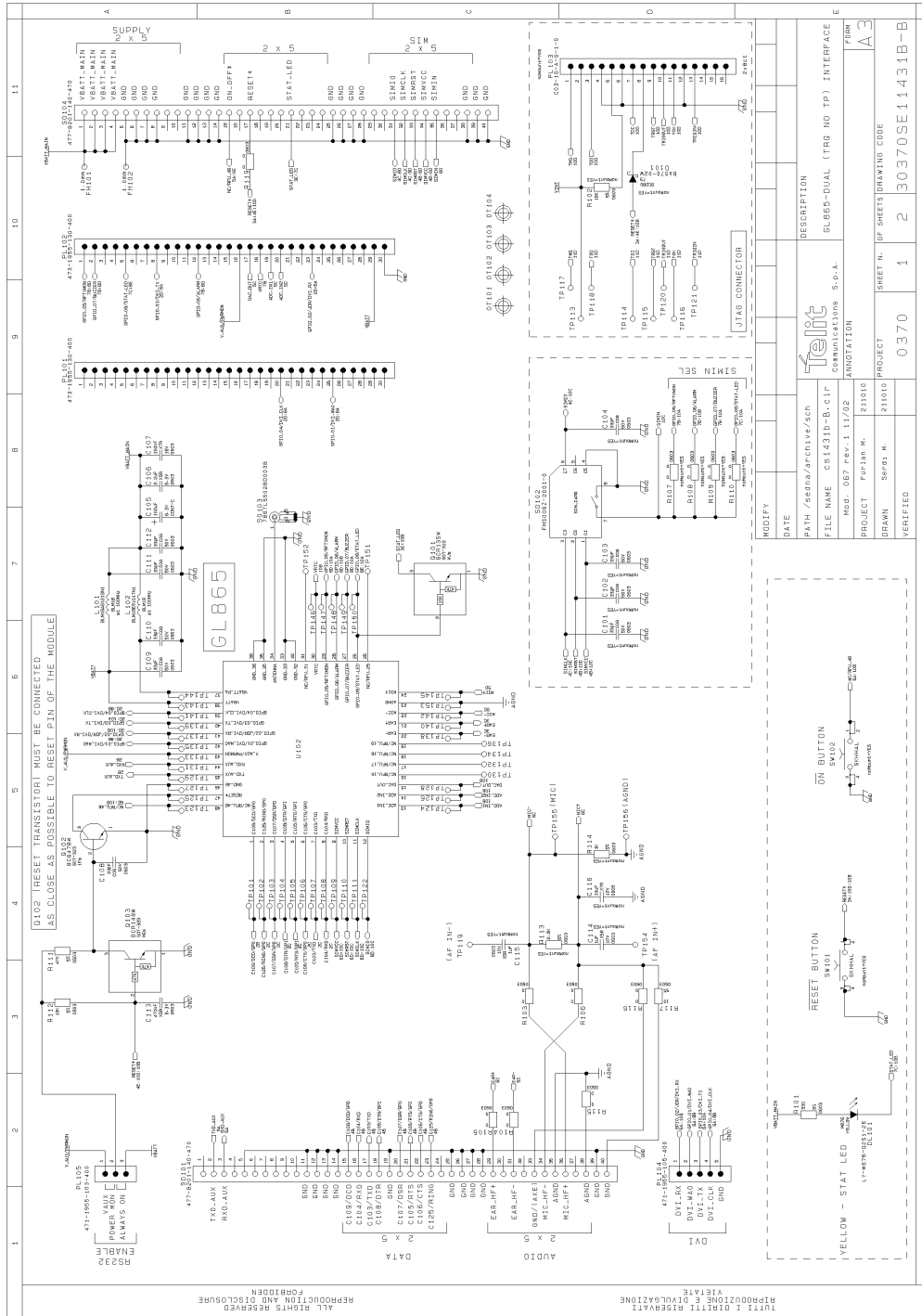

43.11. GC864 Interface board

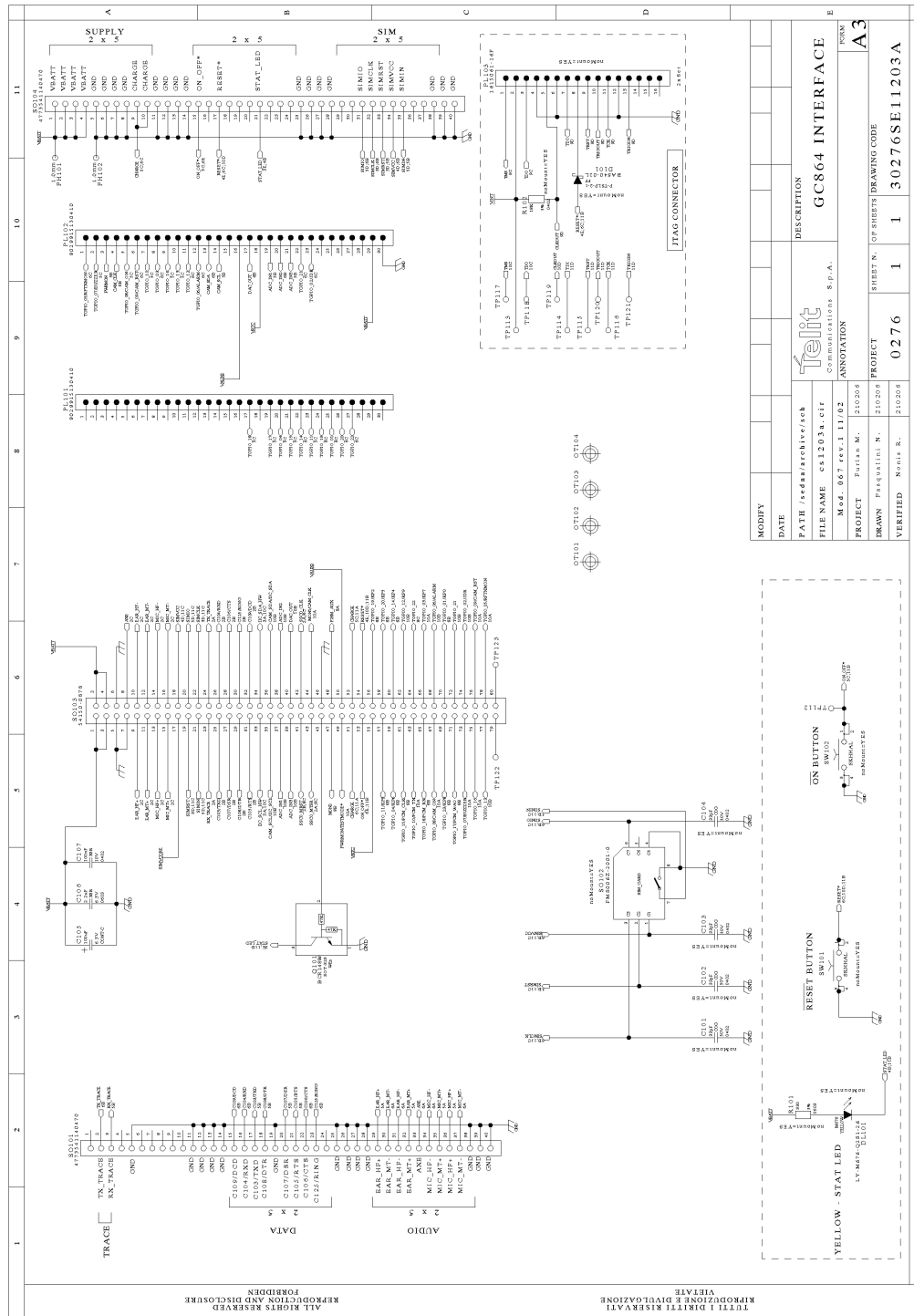

43.12. GC864-C2 Interface board

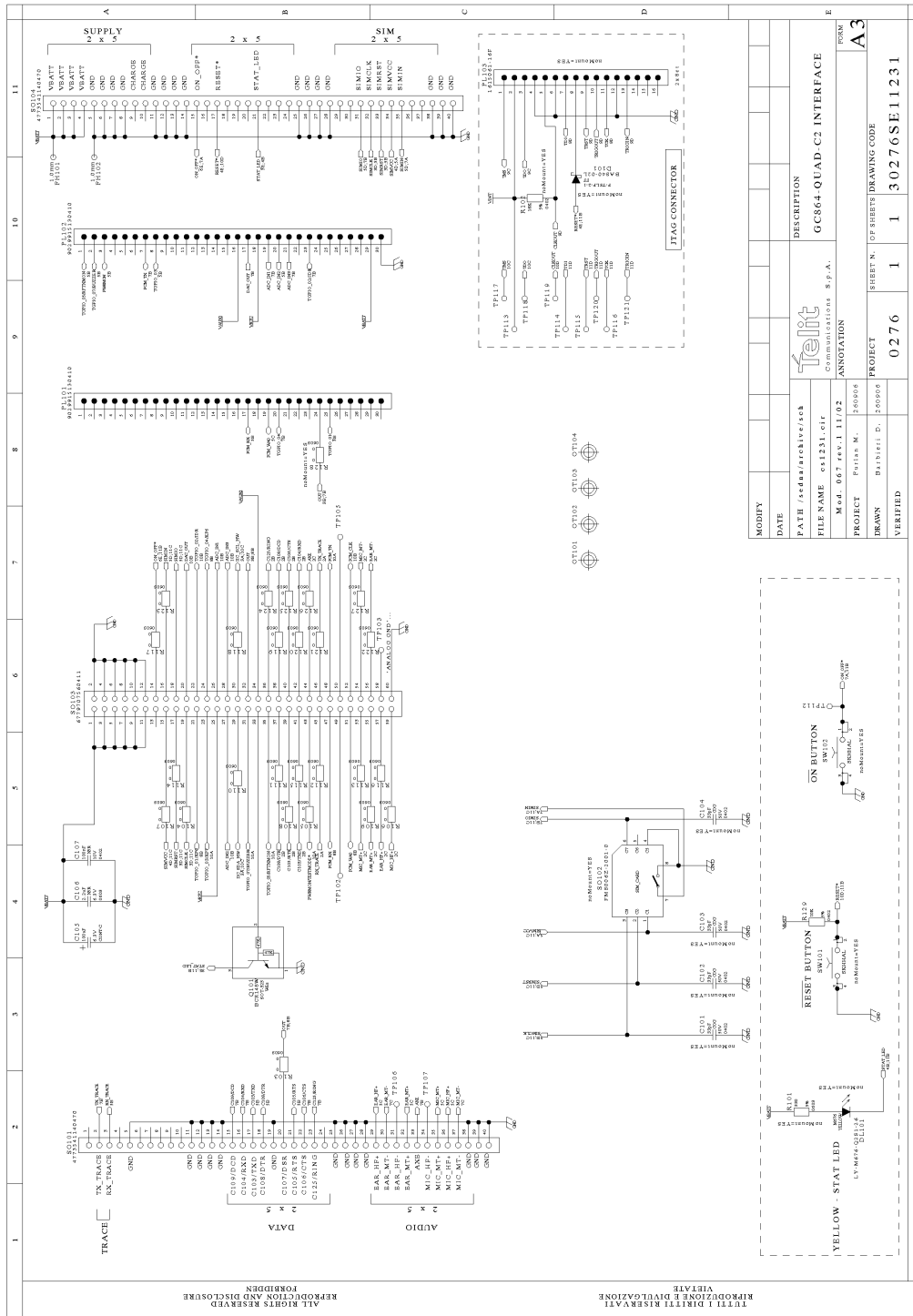

43.13. UC864 Interface board

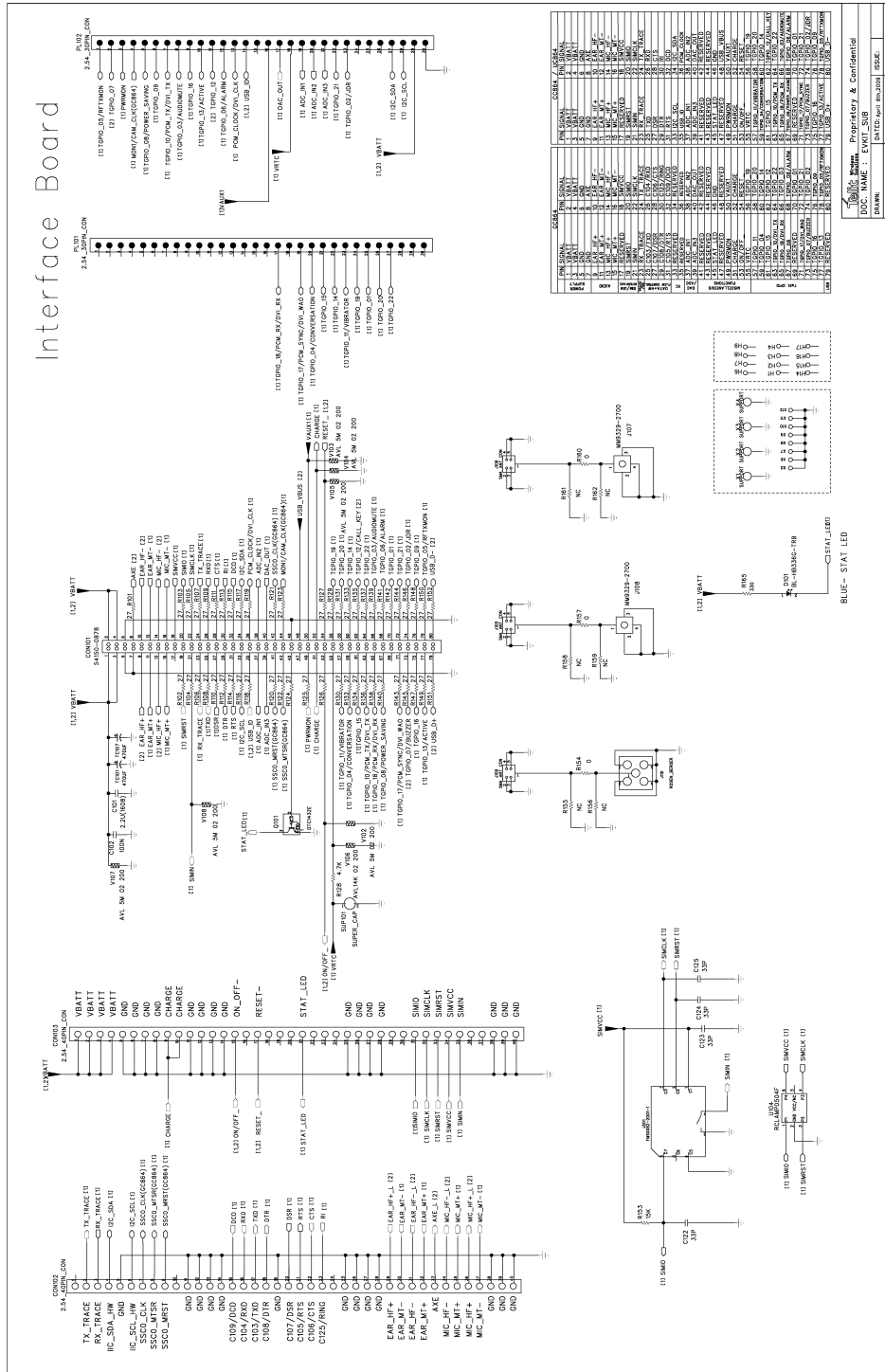

43.14. HE910/UE910 Interface board

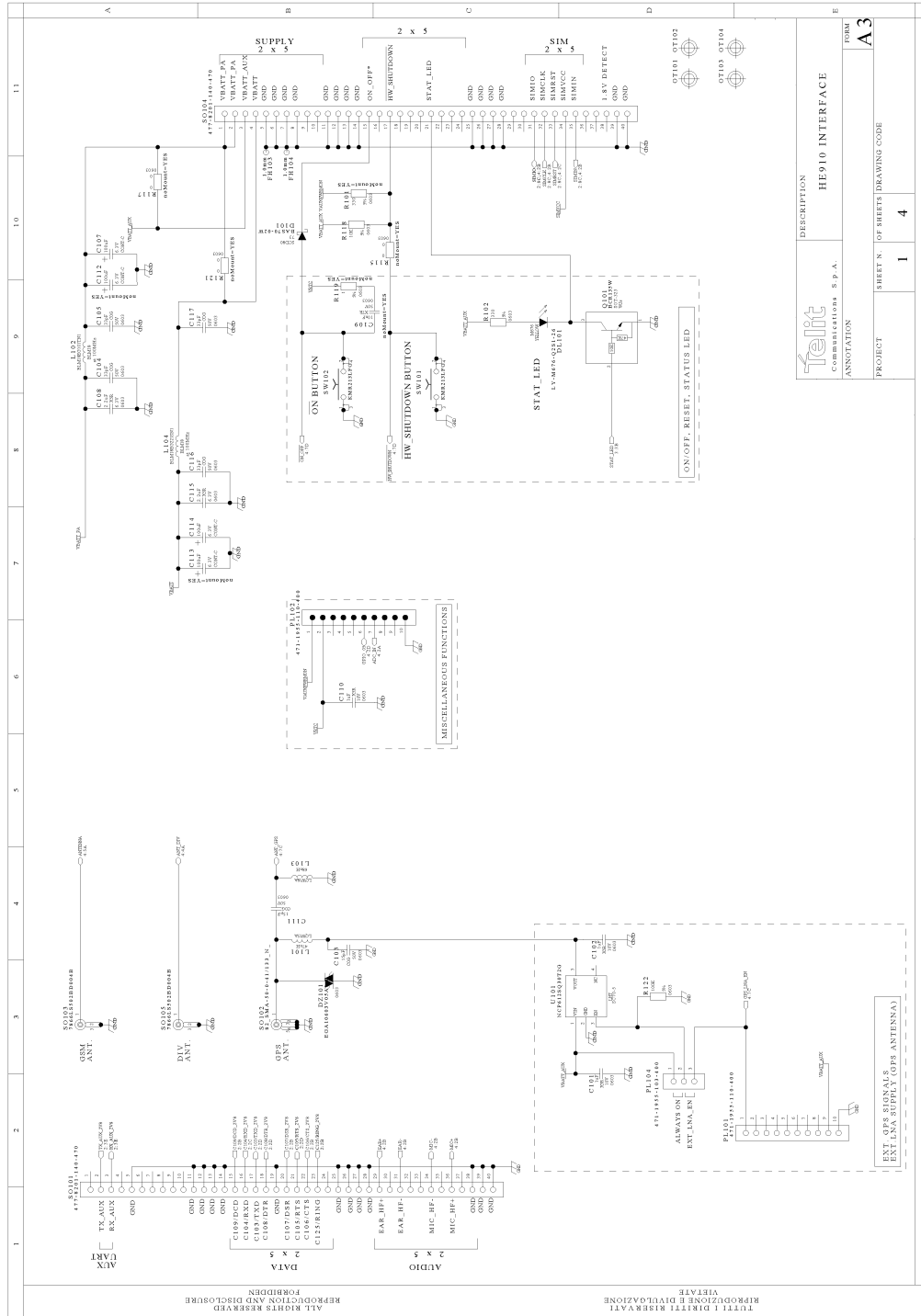

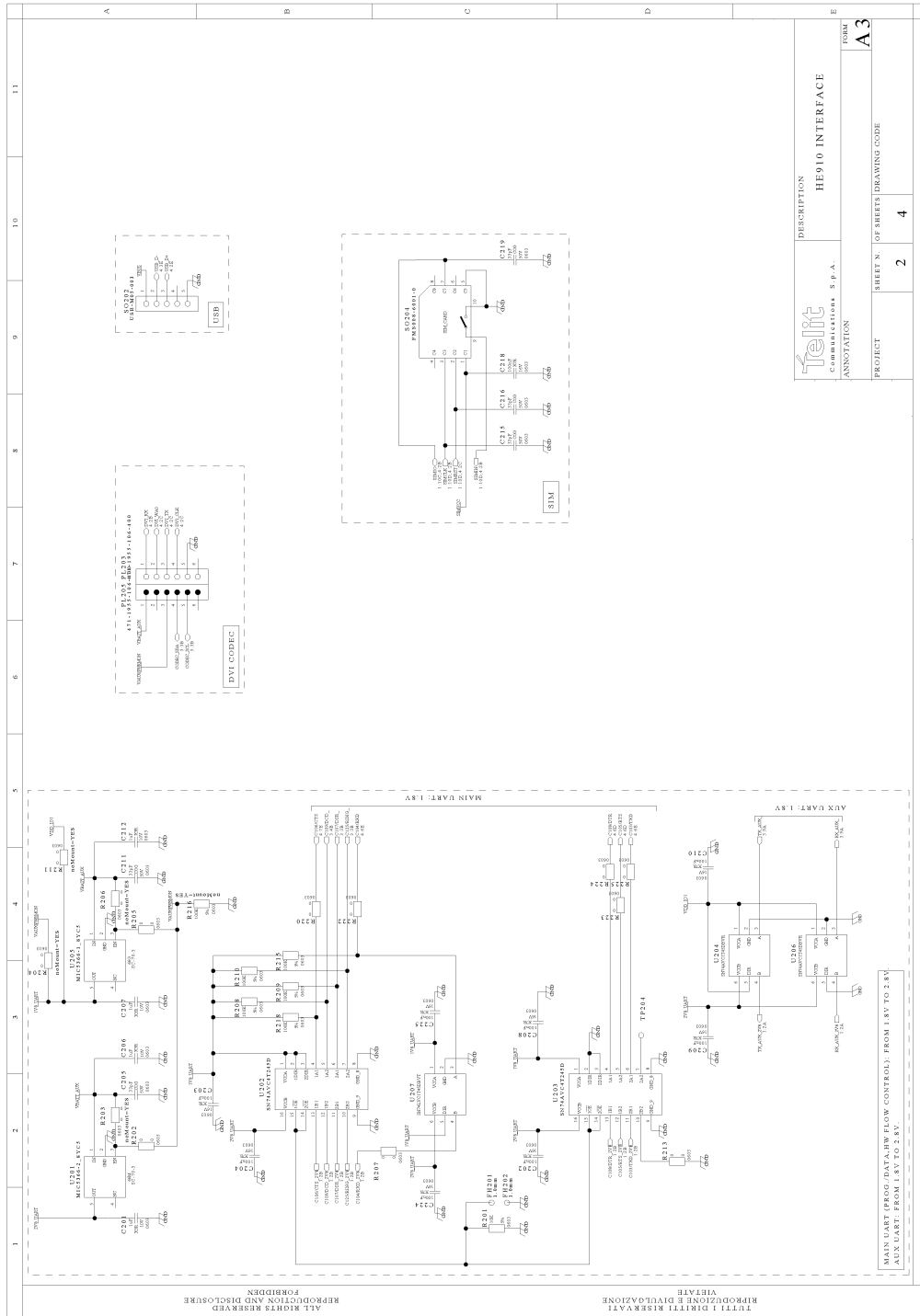

 COMMUNICATIONS S.p.A.	DESCRIPTION	HE910 INTERFACE
	ANNOTATION	
PROJECT	SHEET N.	OF SHEETS DRAWING CODE
	2	4
		A3



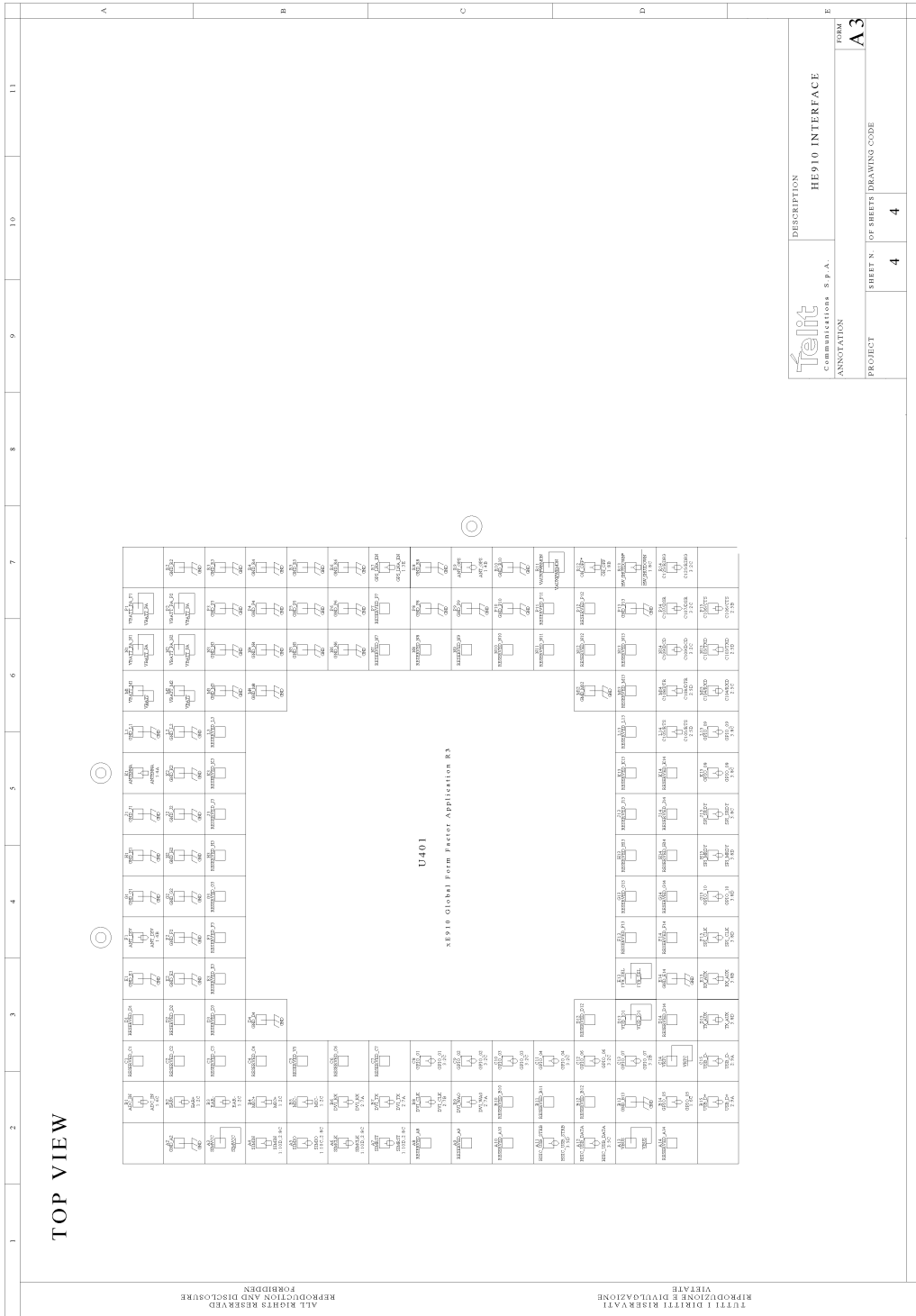

43.15. GE910 Interface board

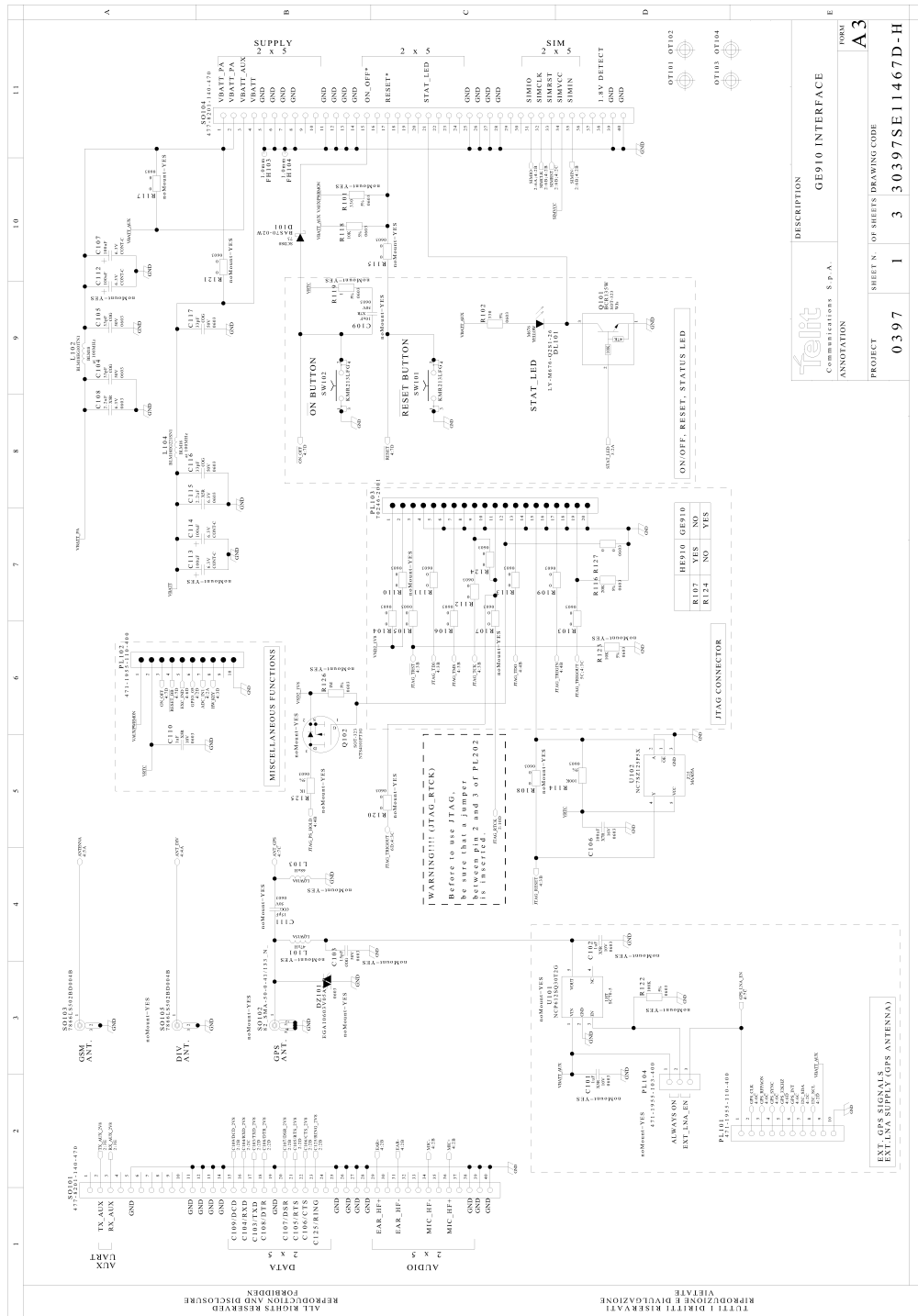

DESCRIPTION	GE910 INTERFACE		
ANNOTATION	COMMUNICATIONS S.p.A.	SHEET N.	OF SHEETS DRAWING CODE
		0397	1 3 30397SE111467D-H
			REV. A3



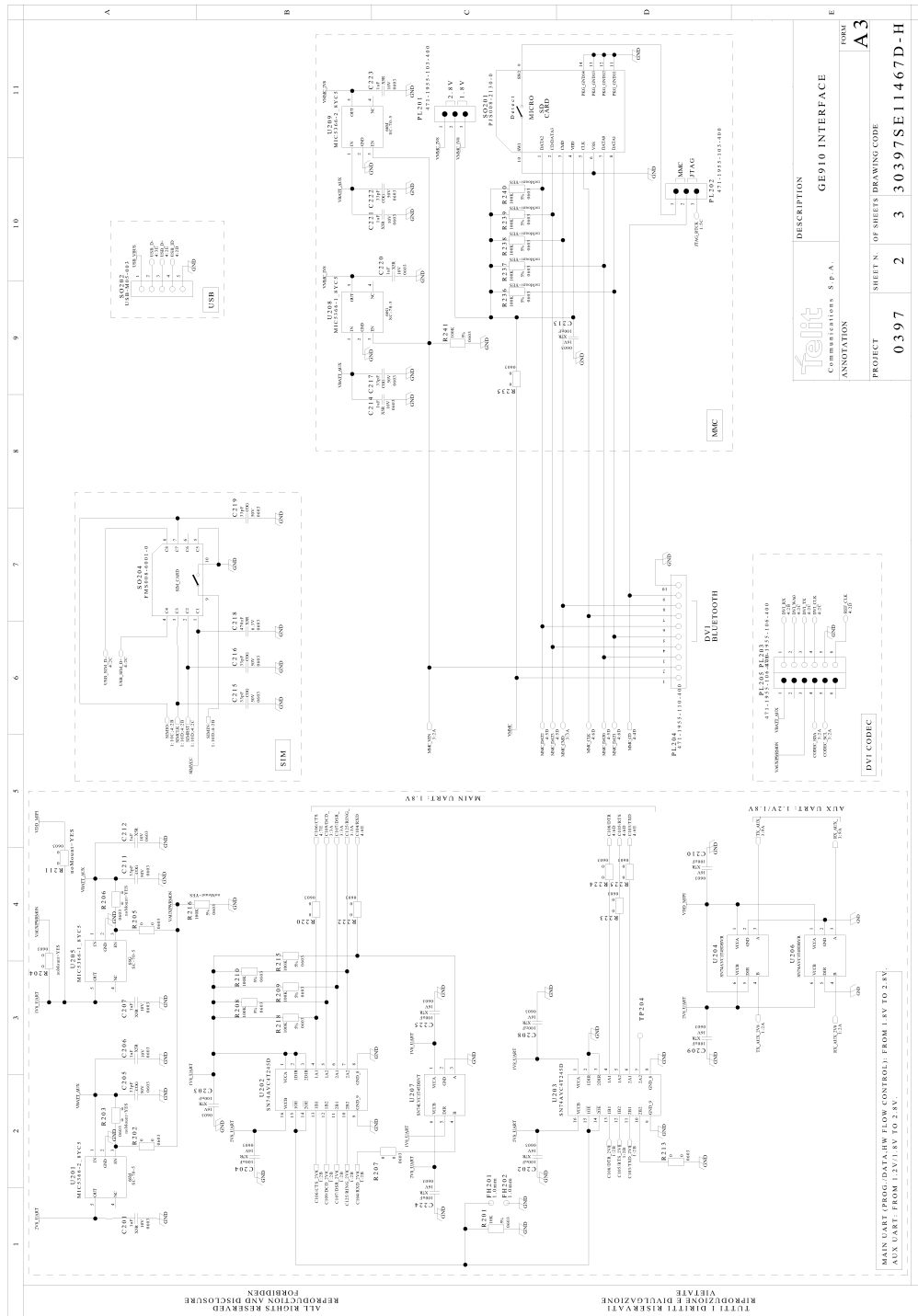

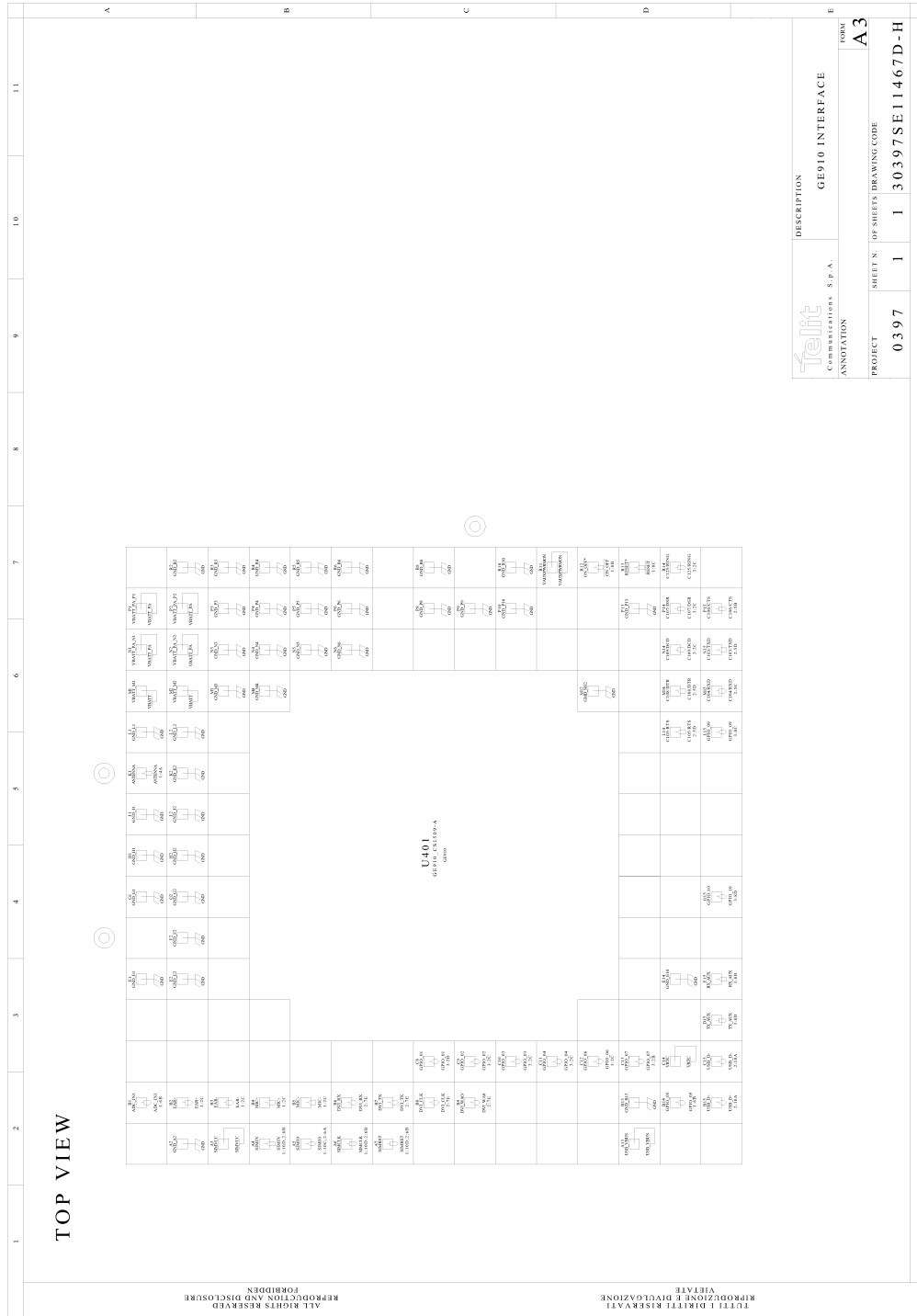

43.16. GE910-GNSS Interface board

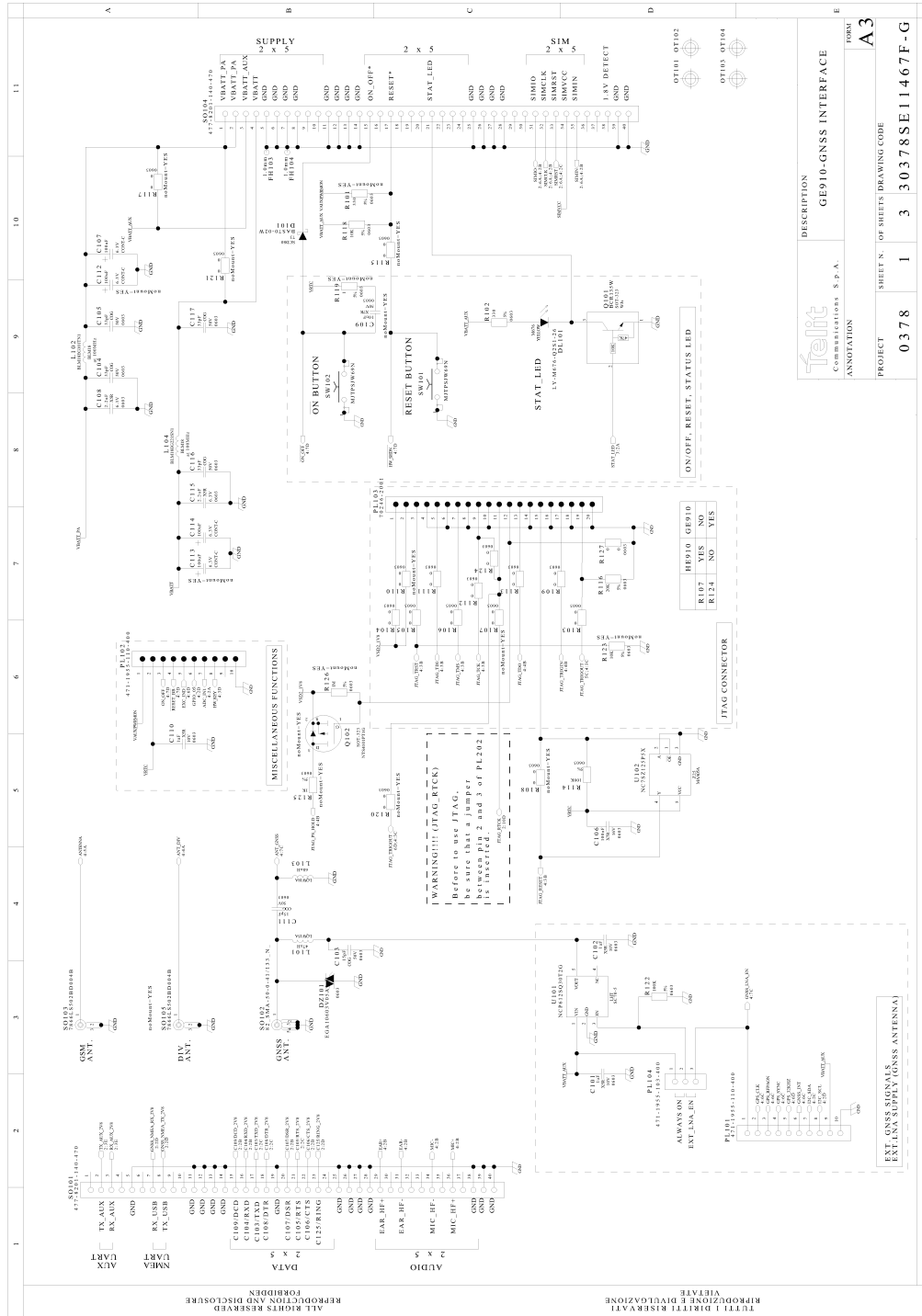

DESCRIPTION		FORM	
GE910-GNSS INTERFACE		A3	
COMMUNICATIONS S.p.A.		PROJECT	
ANNOTATION		SHEET N. OF SHEETS DRAWING CODE	
0378		1 3 30378SE11467F-G	



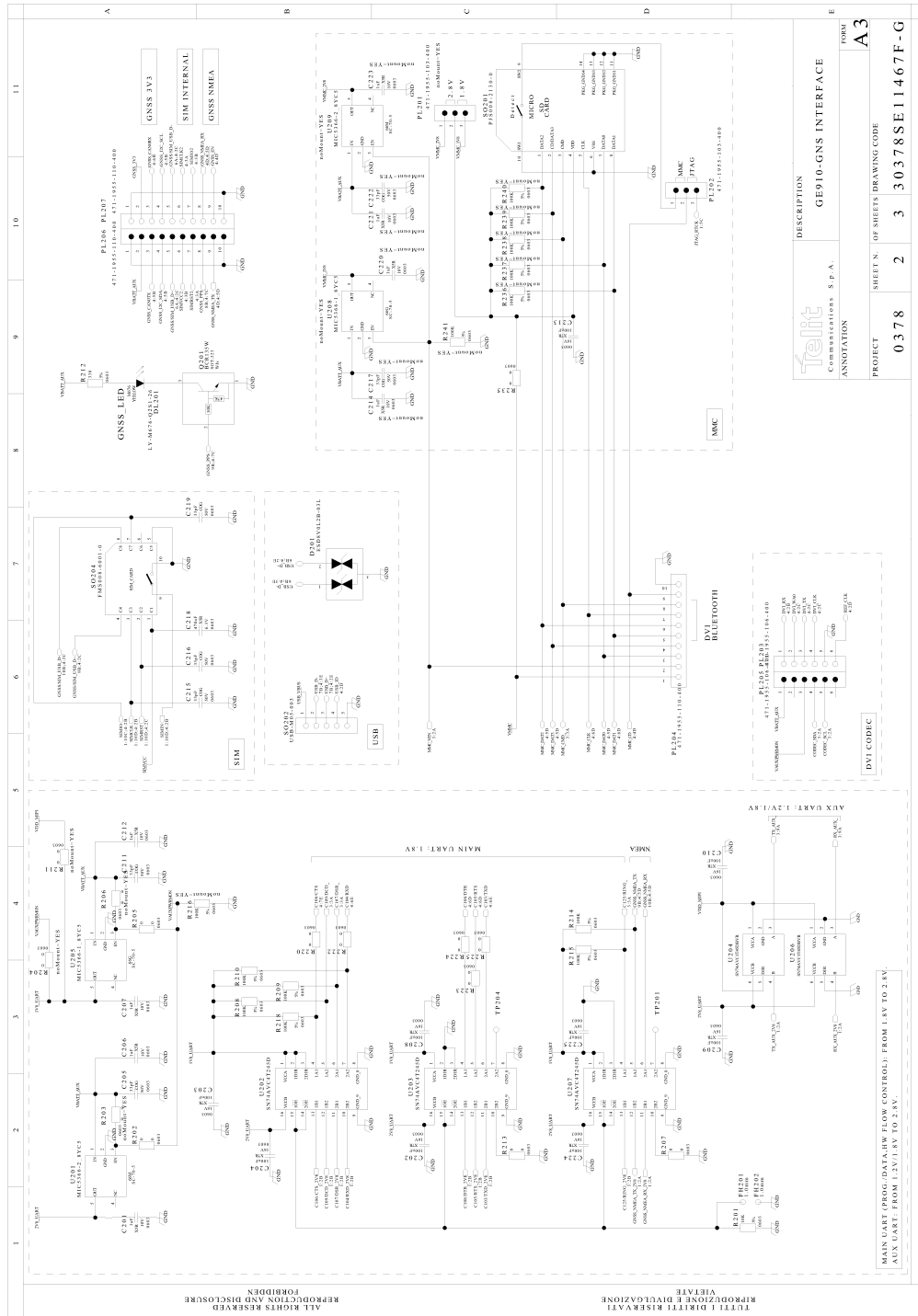

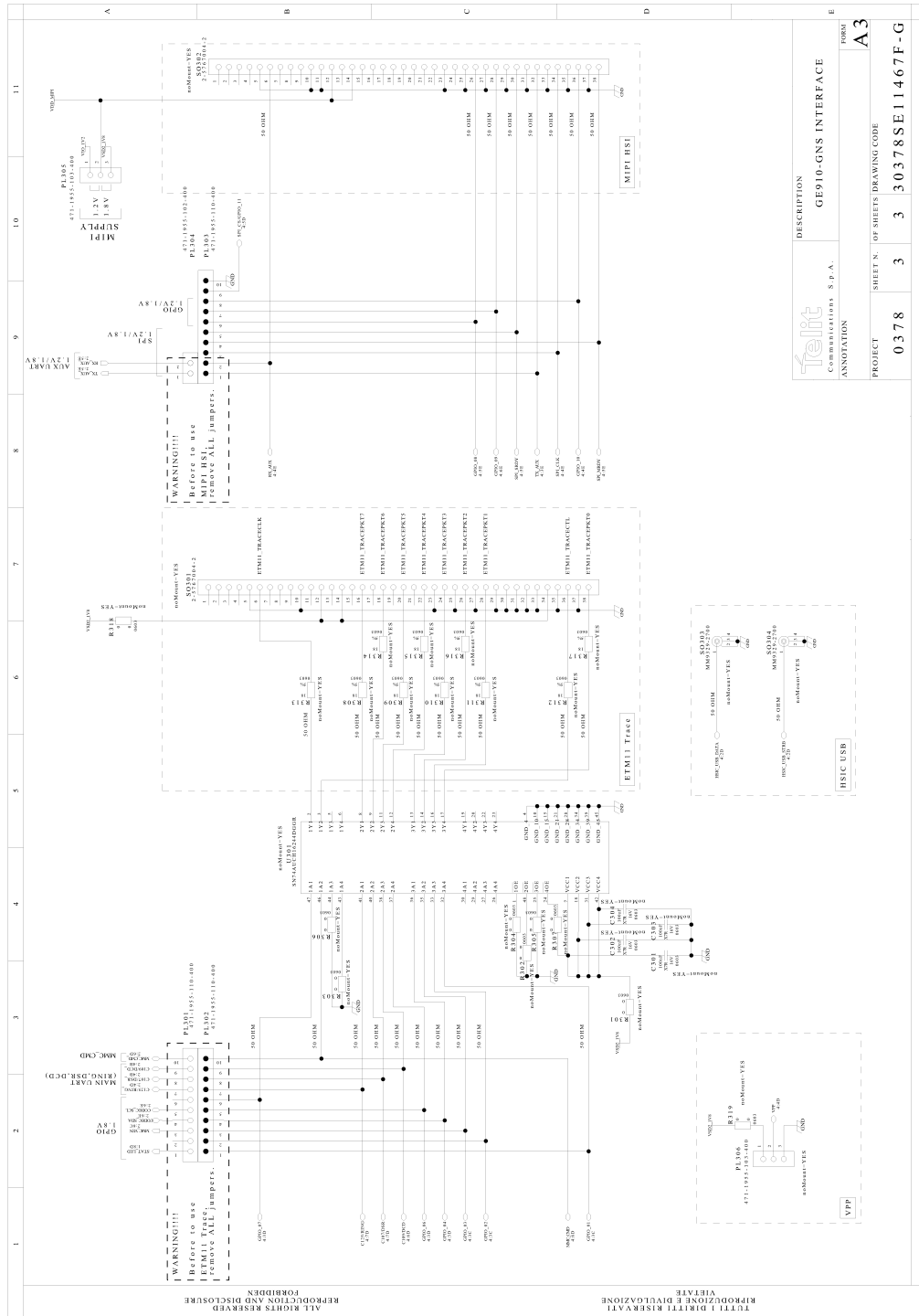

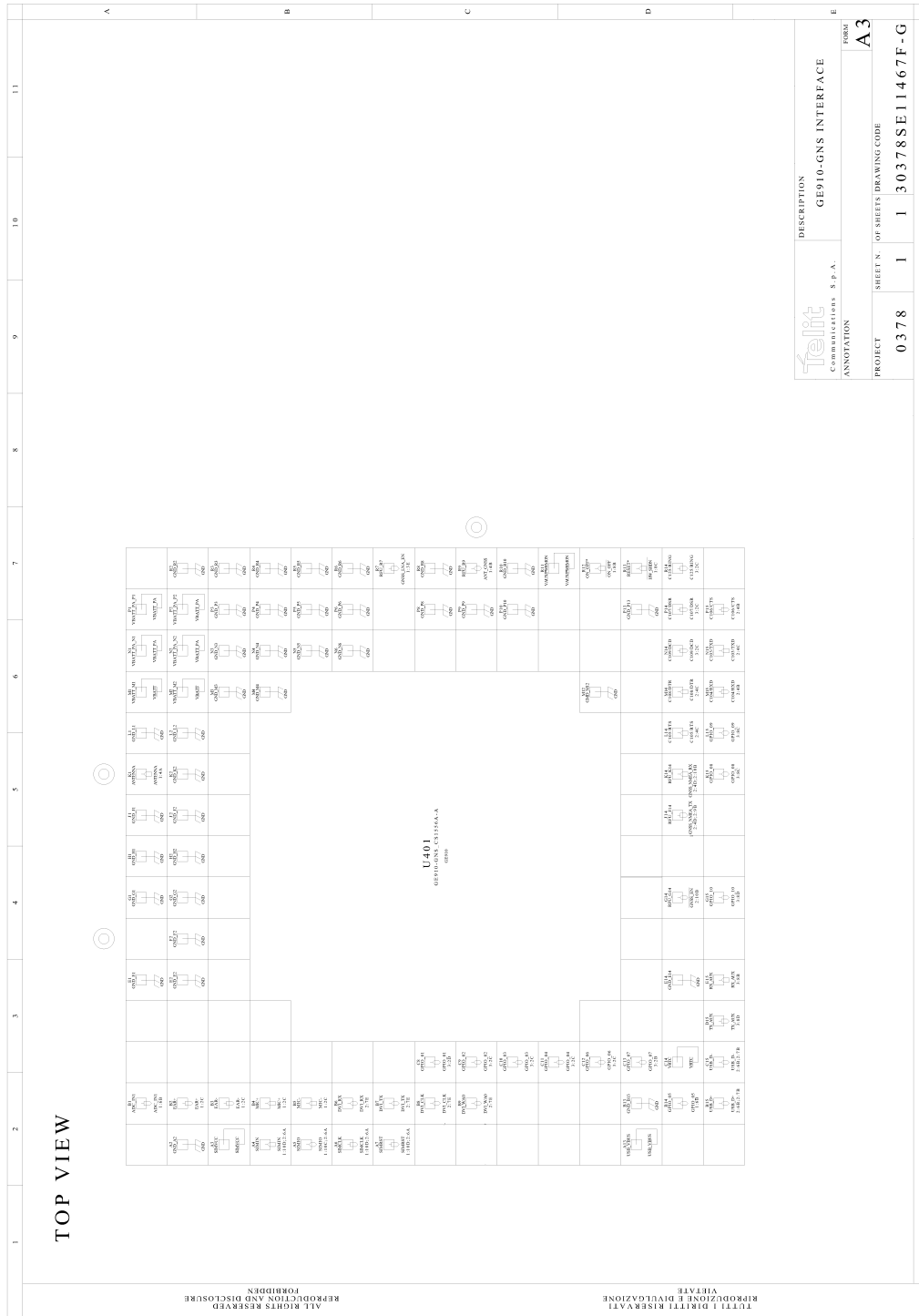

43.17. GE910-QUAD V3 Interface board

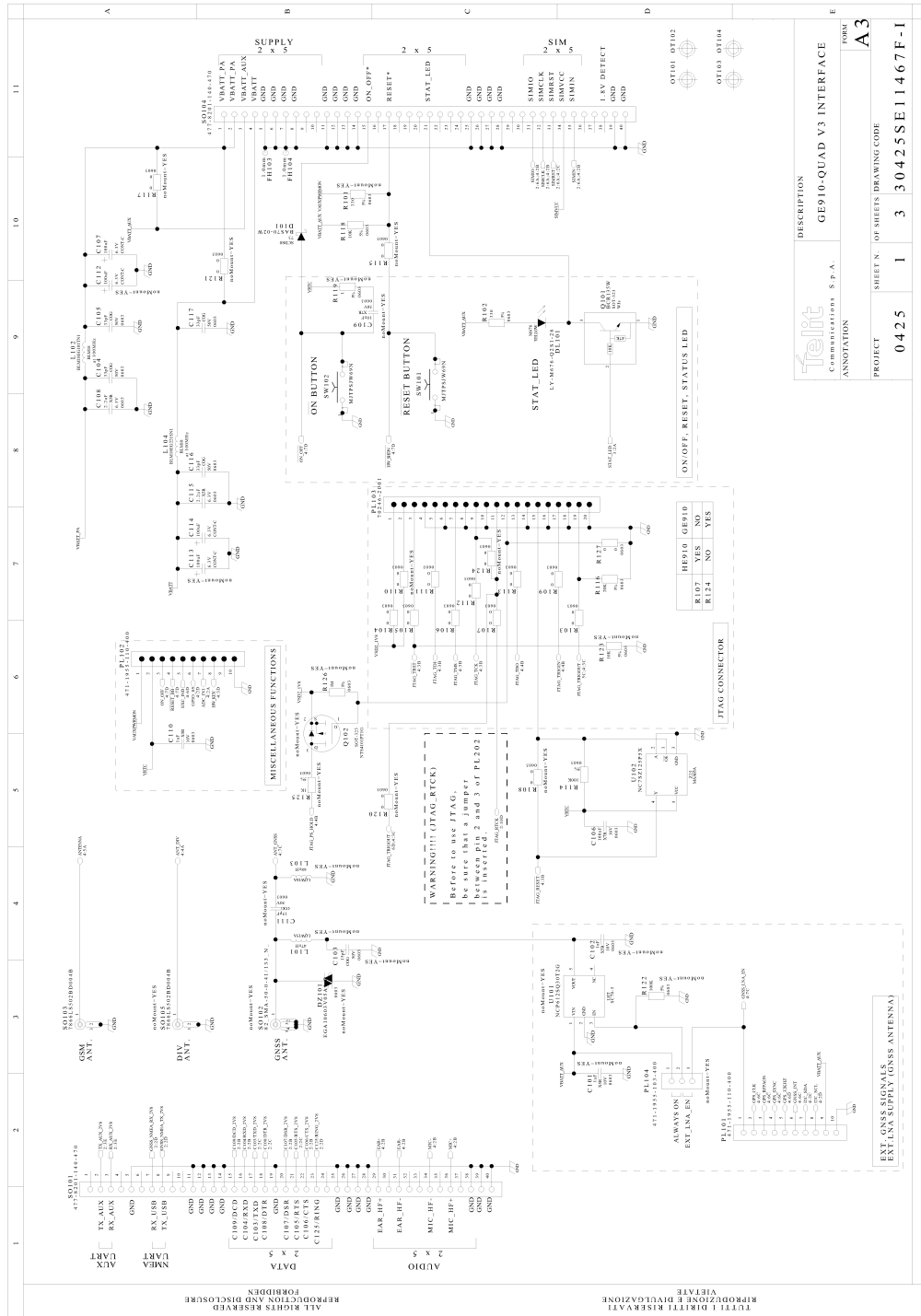

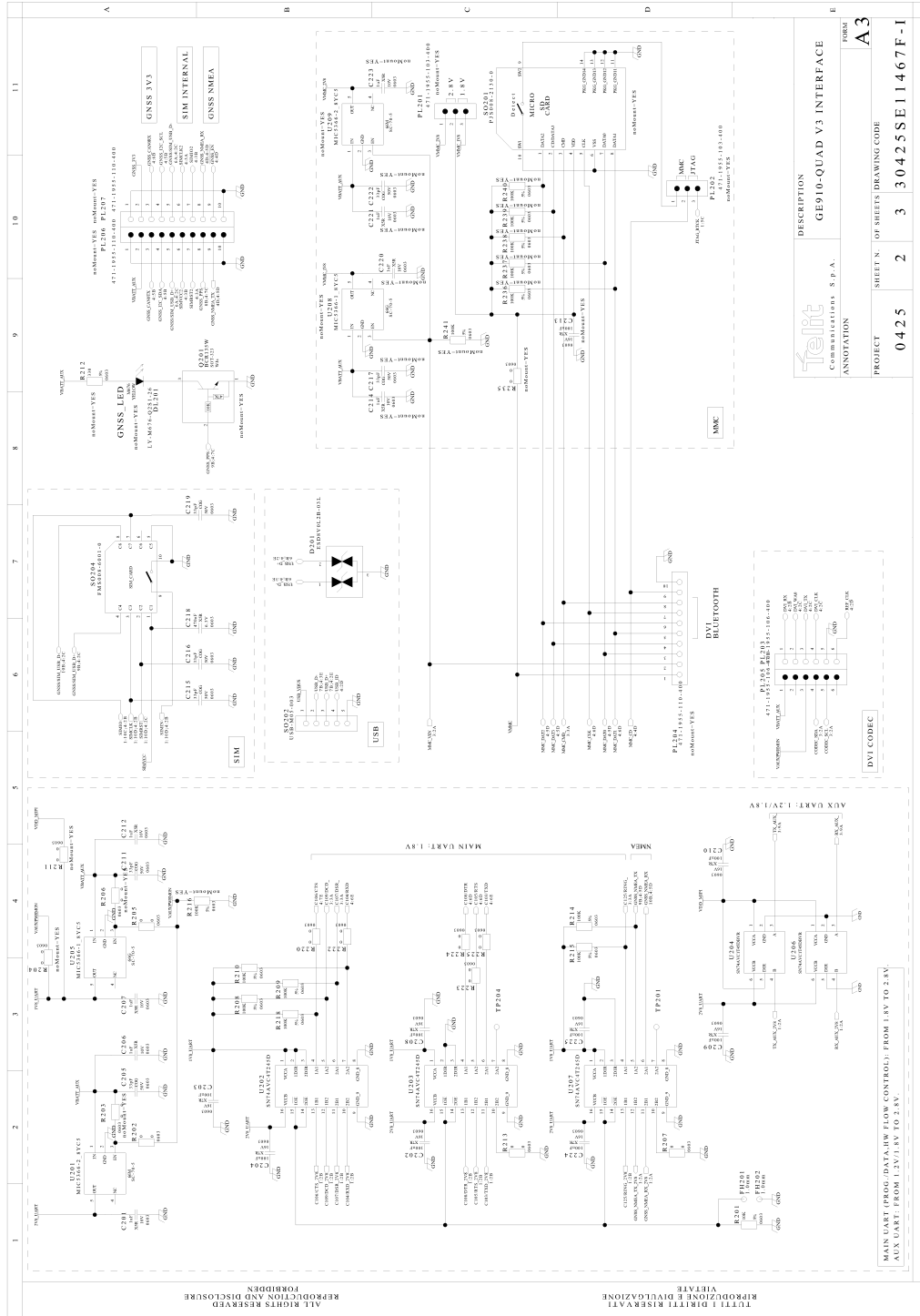

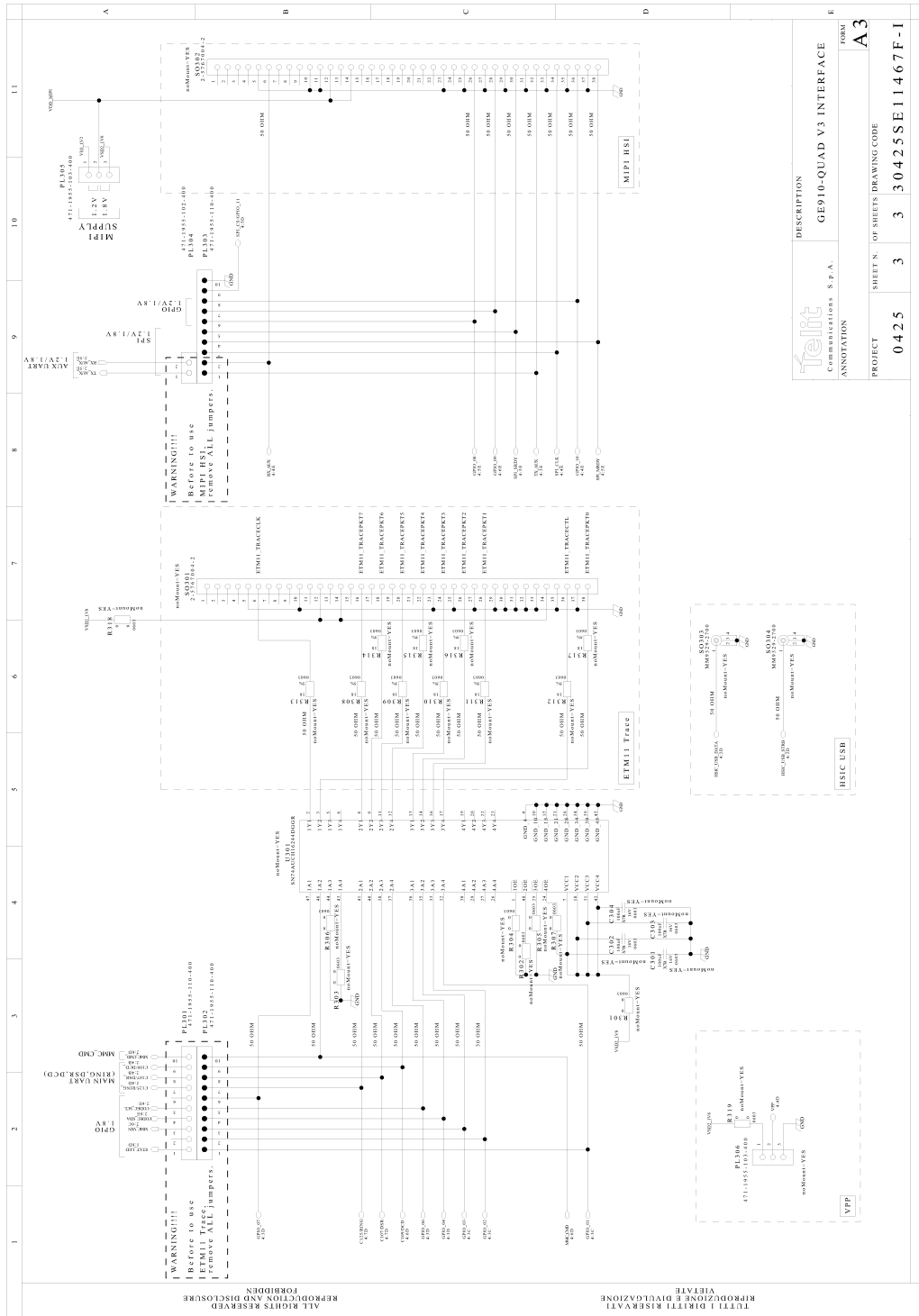

 COMMUNICATIONS S.P.A.	DESCRIPTION	GE910-QUAD V3 INTERFACE	FORMA
	ANNOTATION		A3
PROJECT	0425	SHEET N. 3	101 SHEETS
		DRAWING CODE	30425SE11467F-1



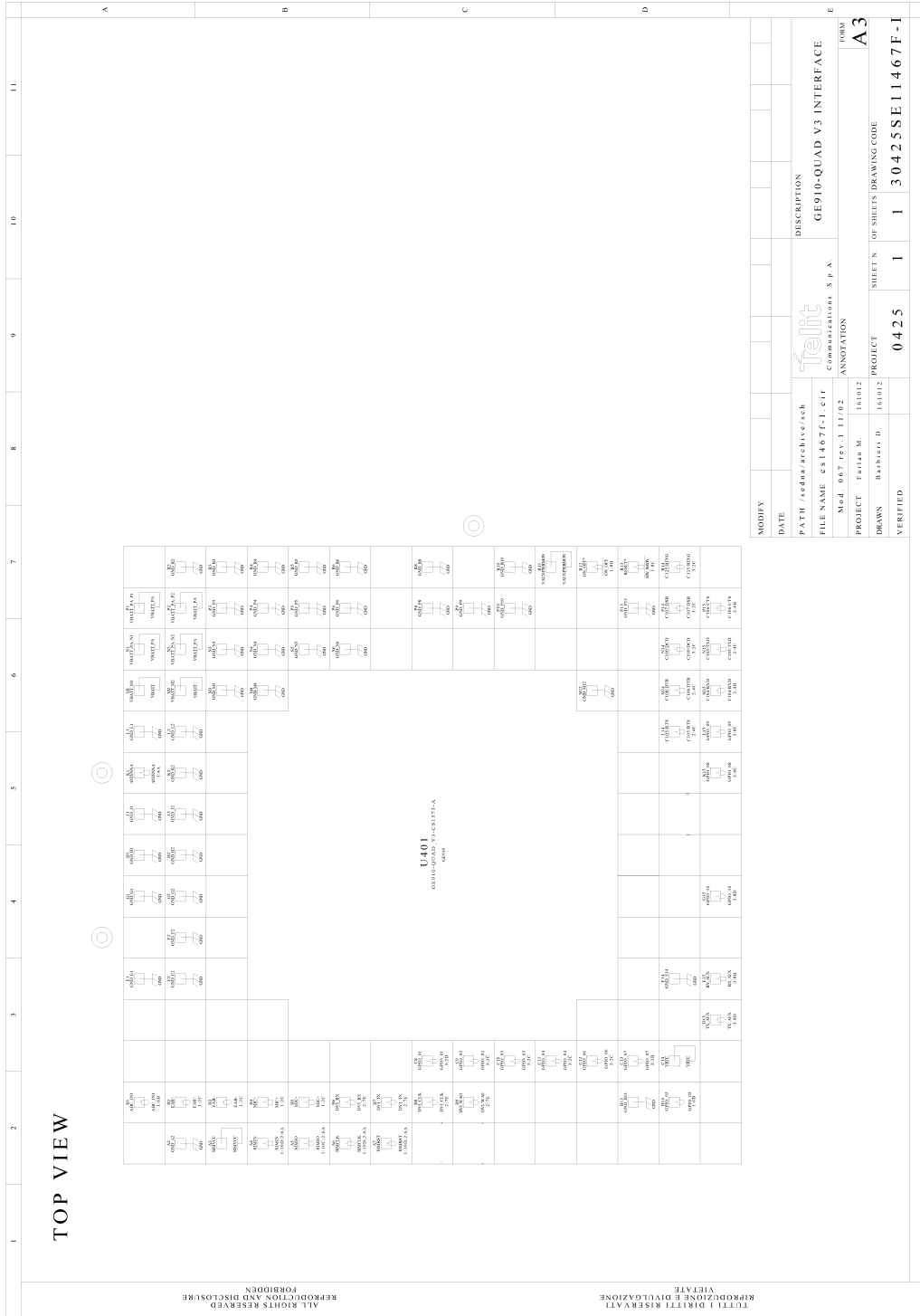

43.18. GE865 – JF2 Interface board

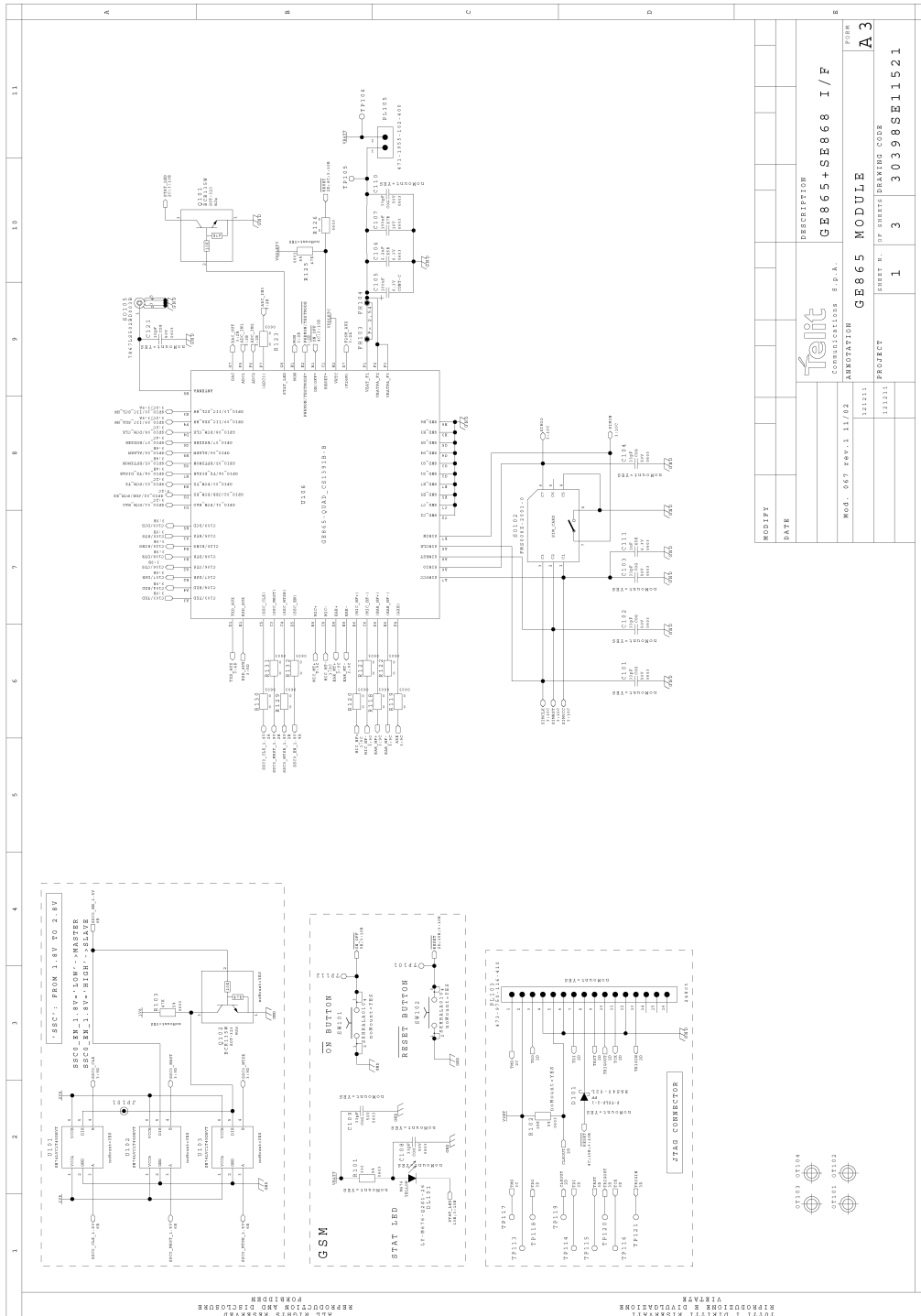

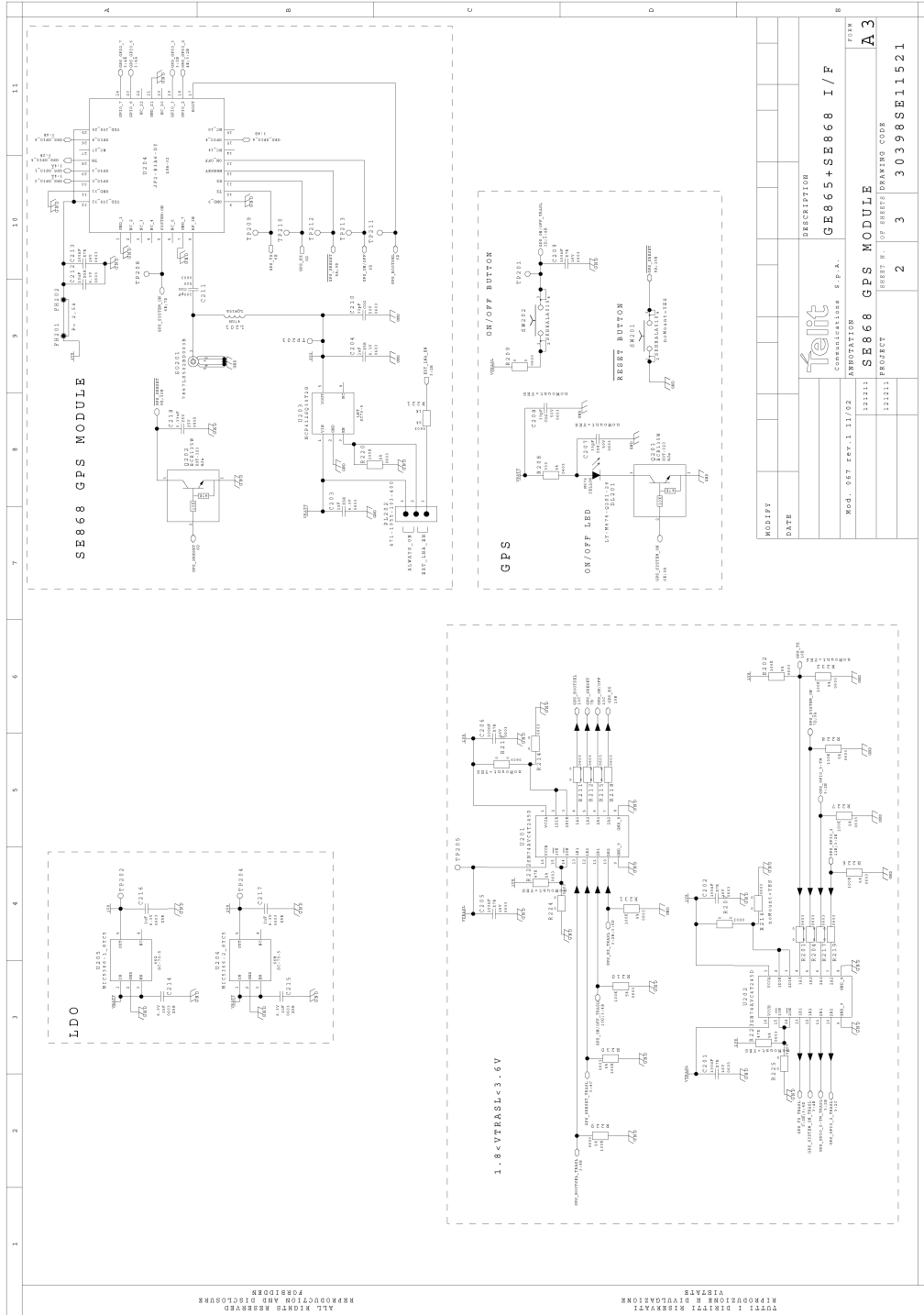

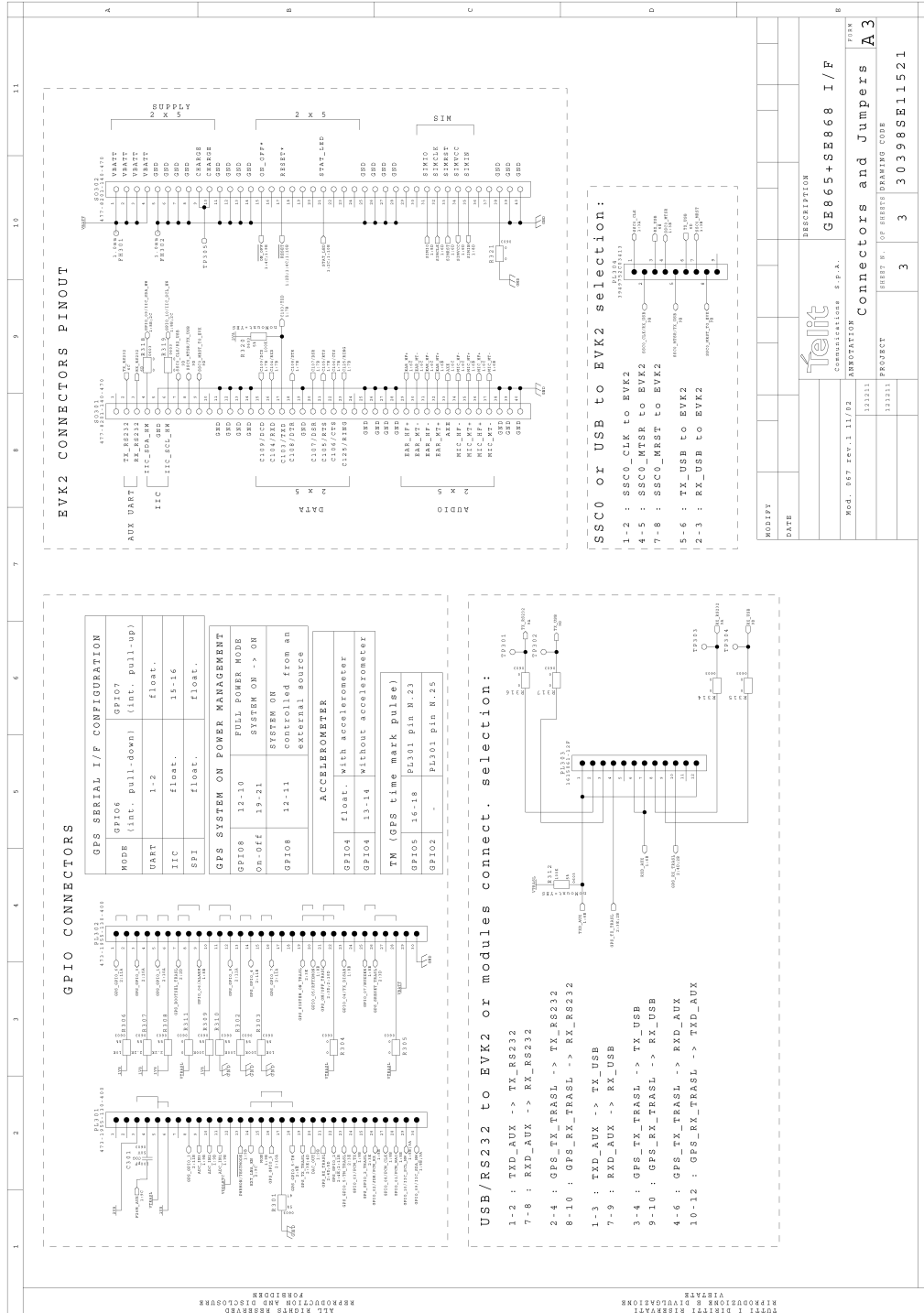

43.19. GL865 – SL869/JN3 Interface board

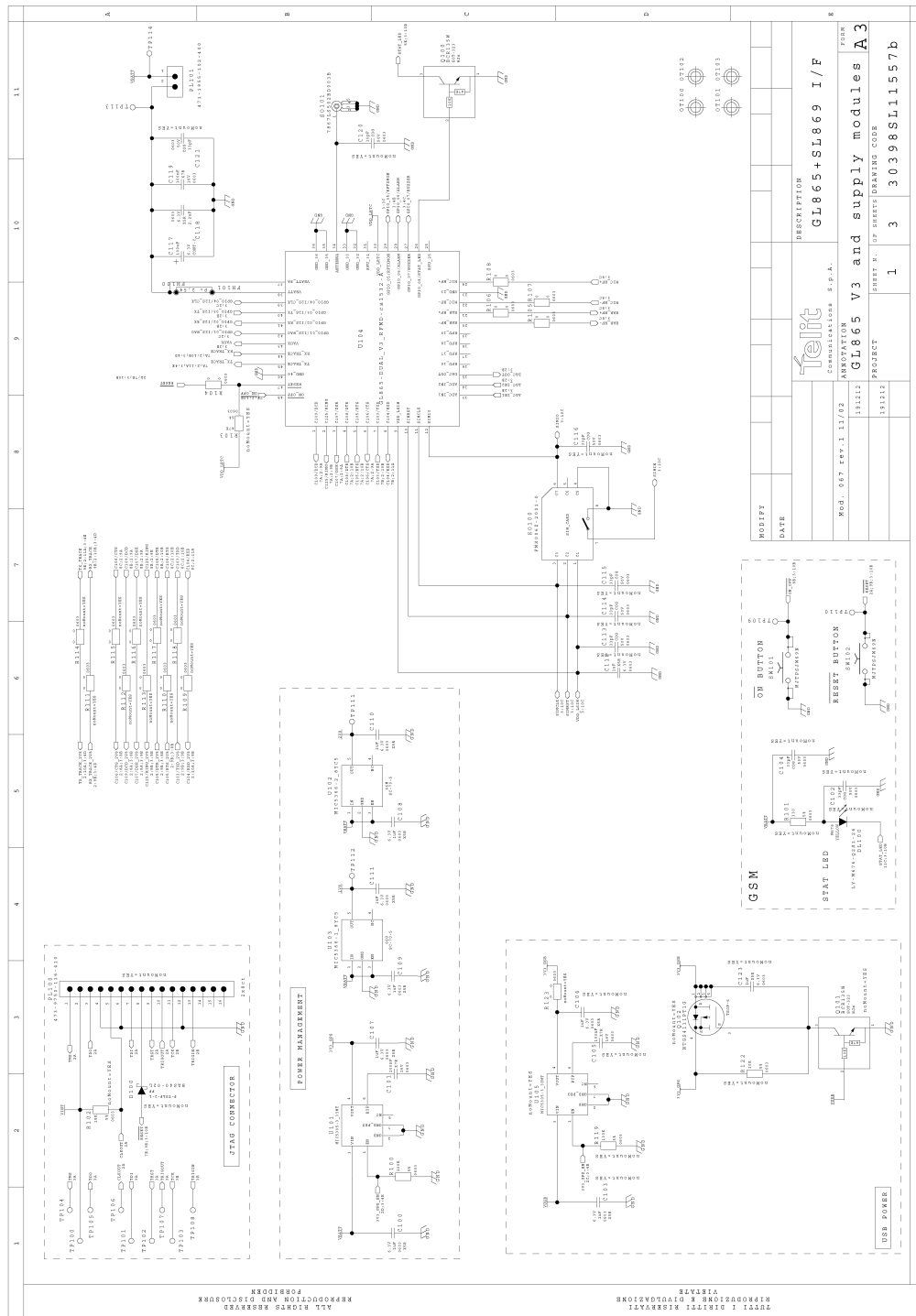

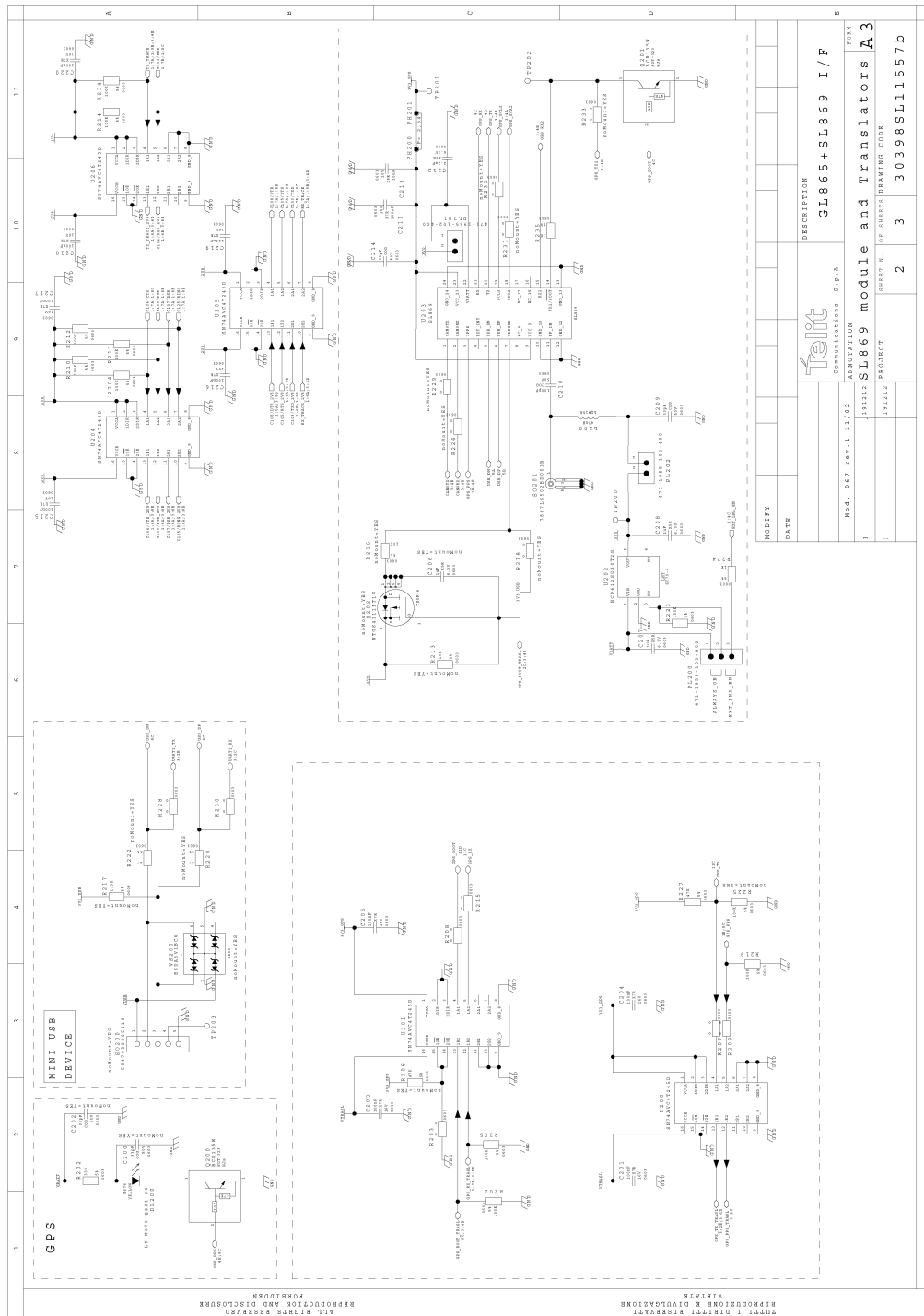

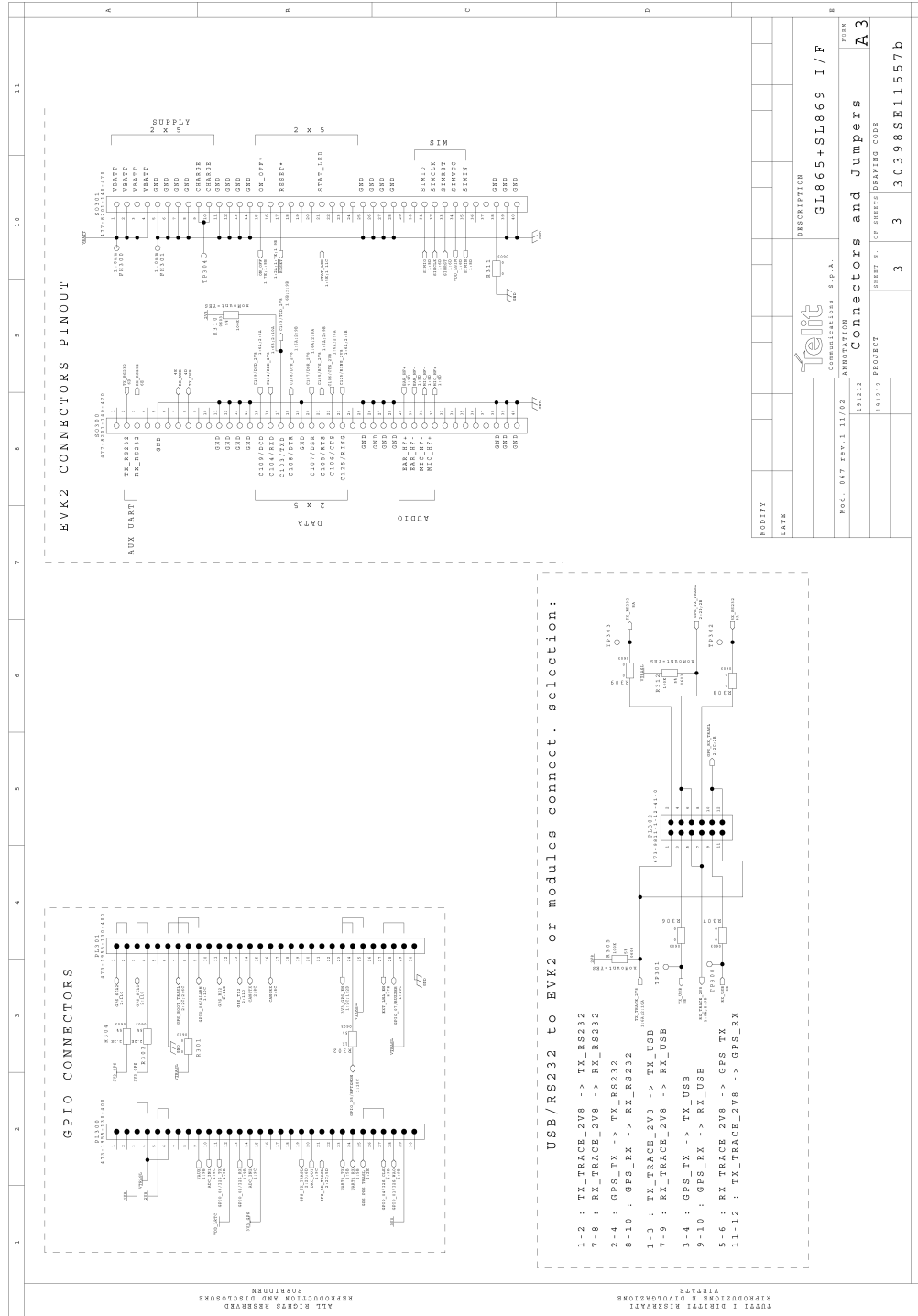

43.20. DE910 Interface board

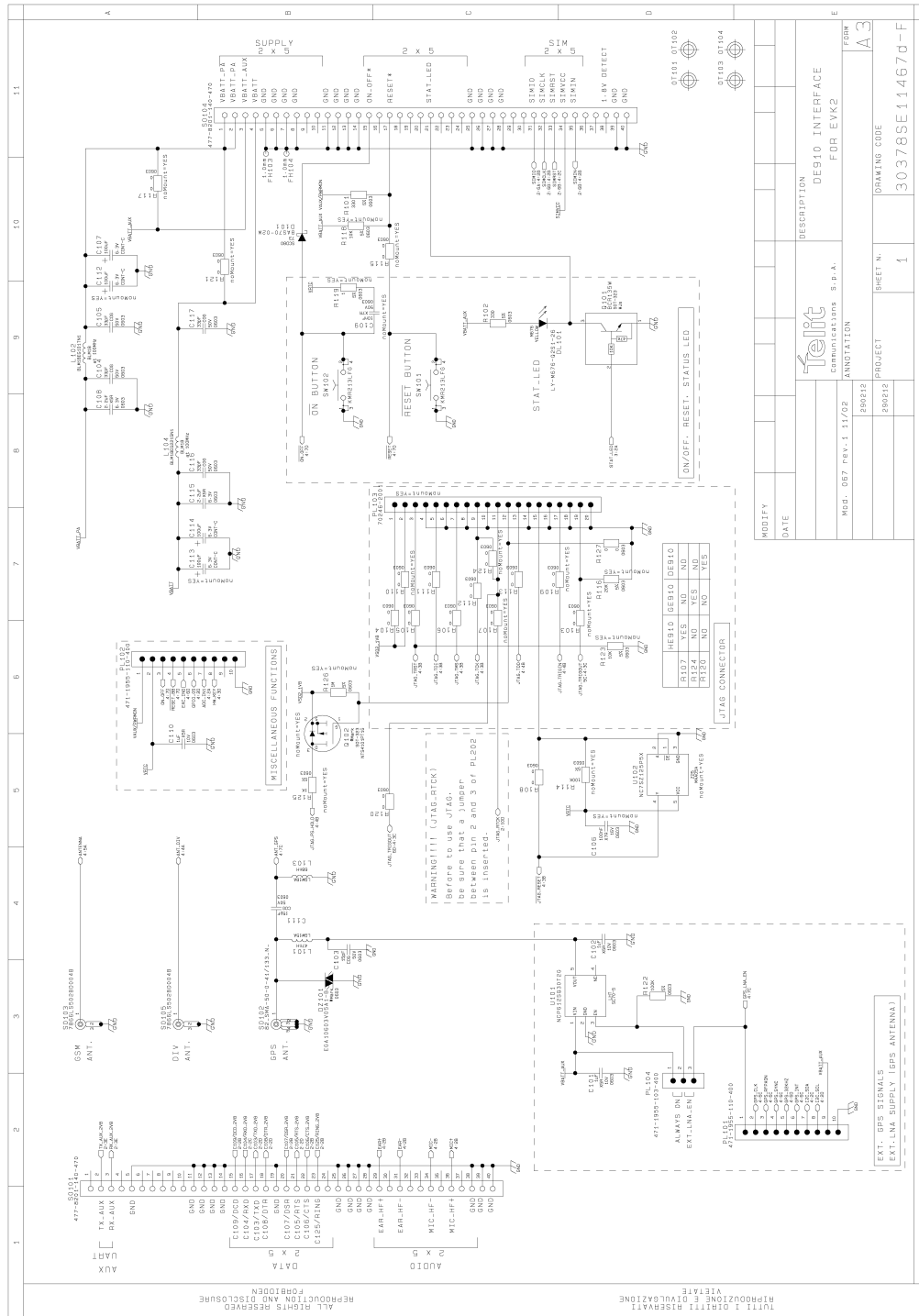

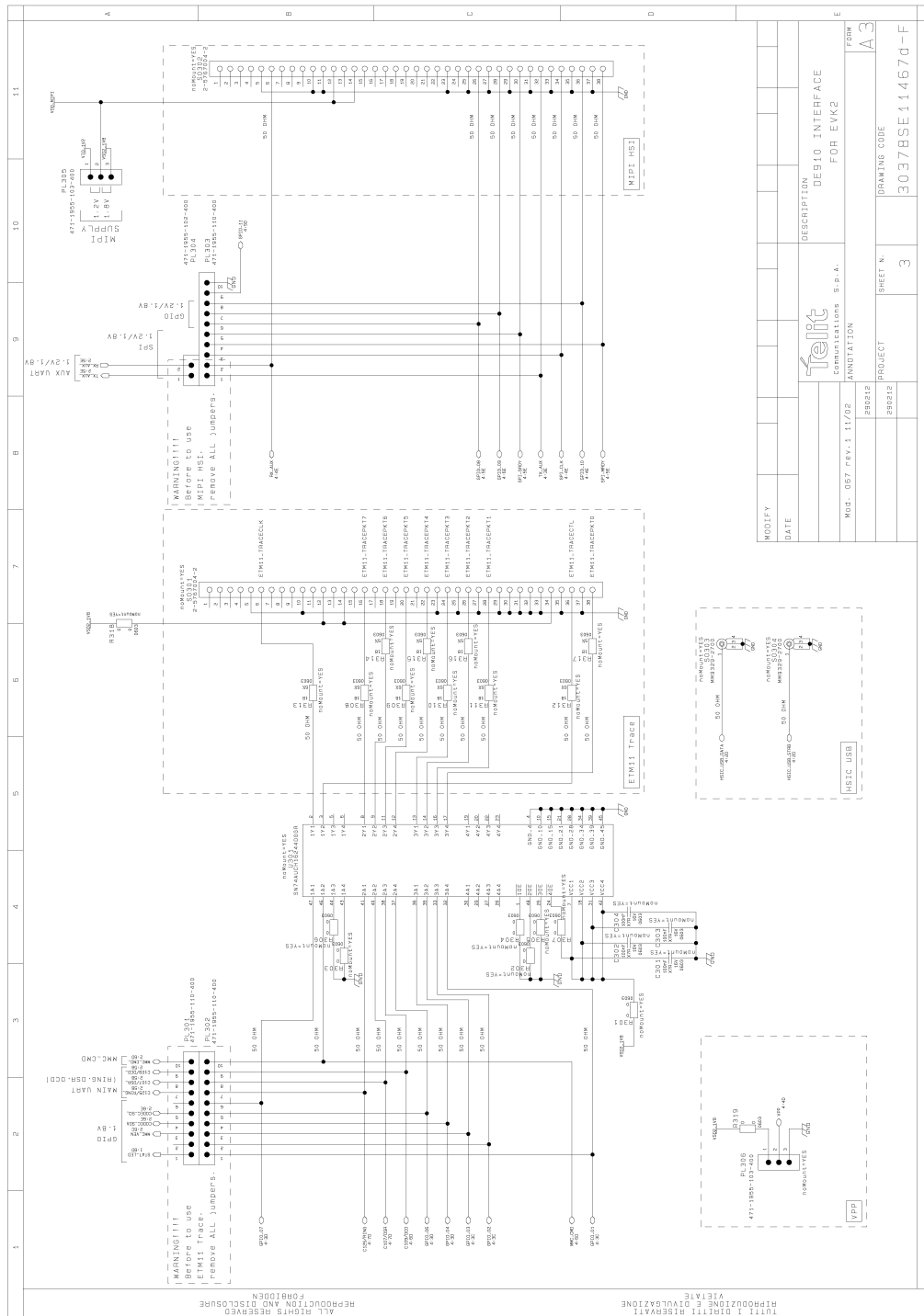

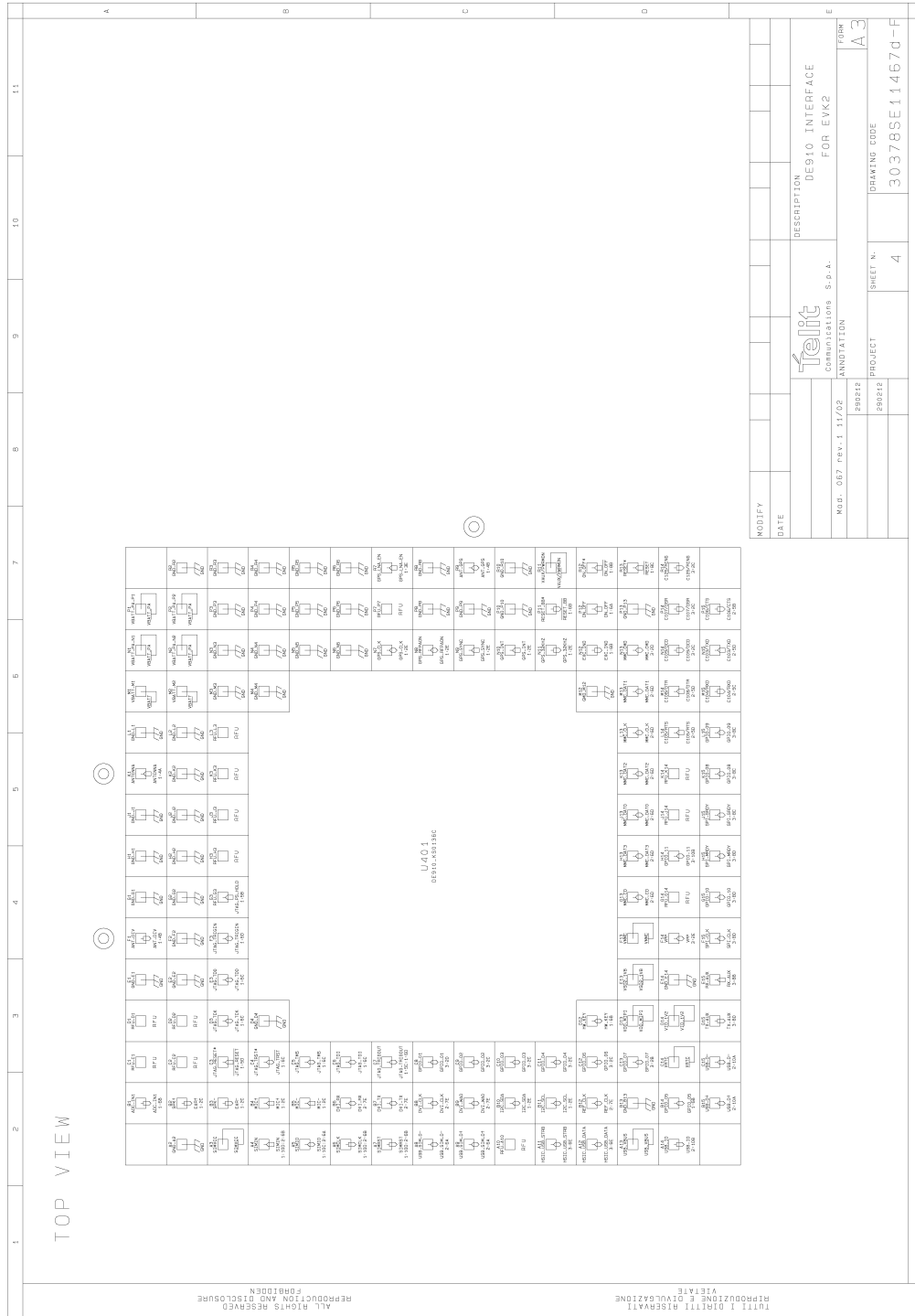

43.21. CE910 Interface board

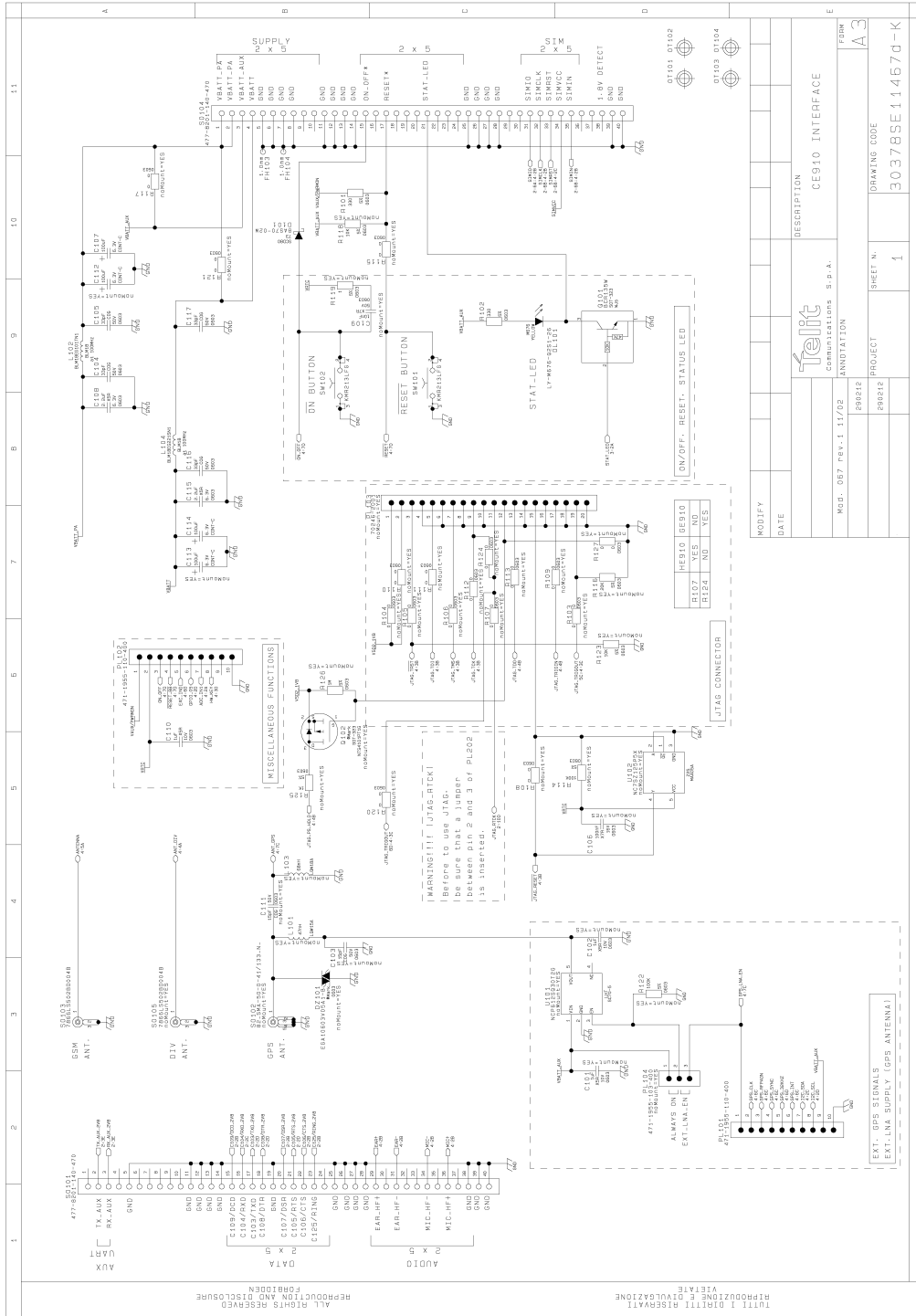

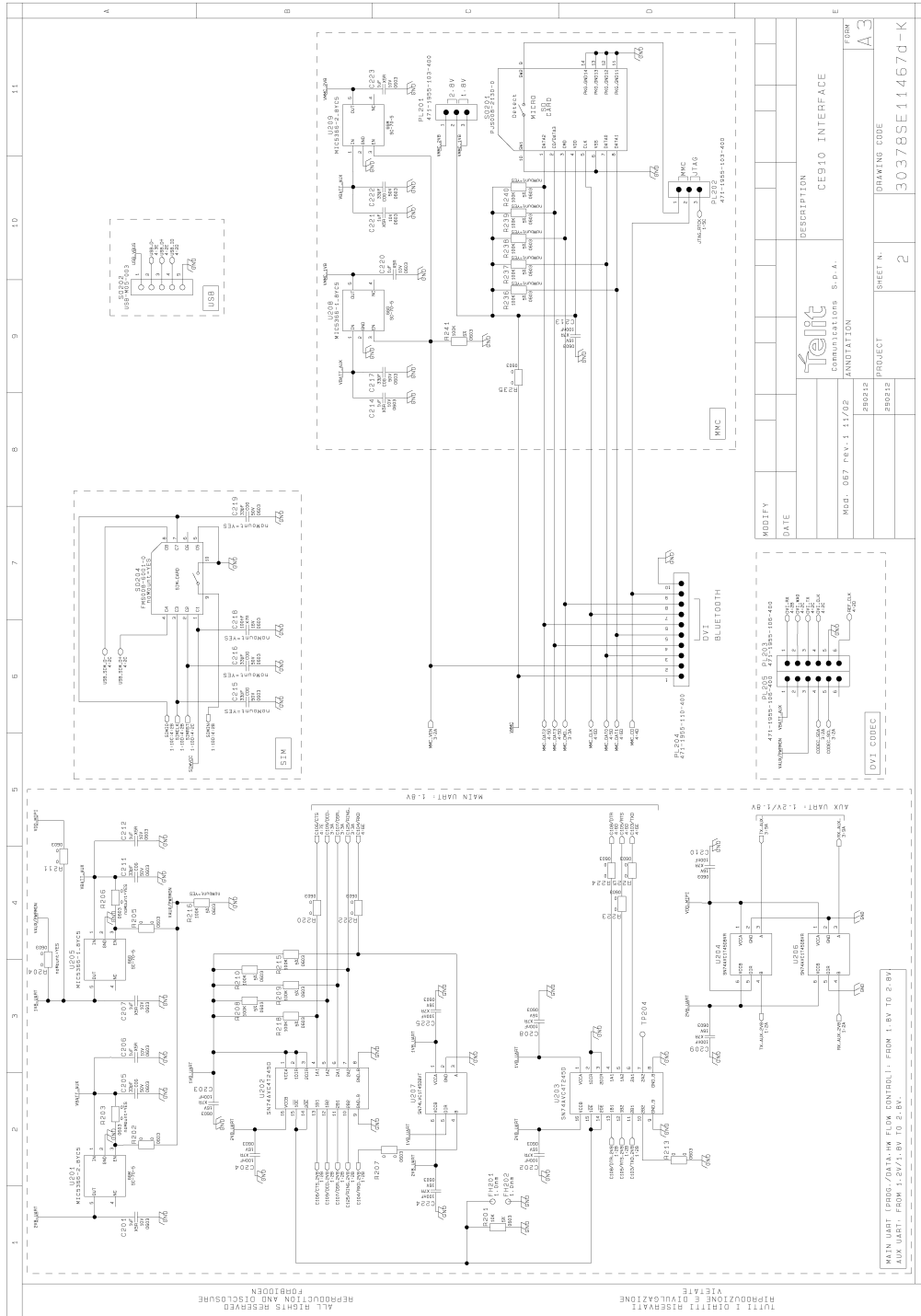

43.22. GL865 V3 Interface board

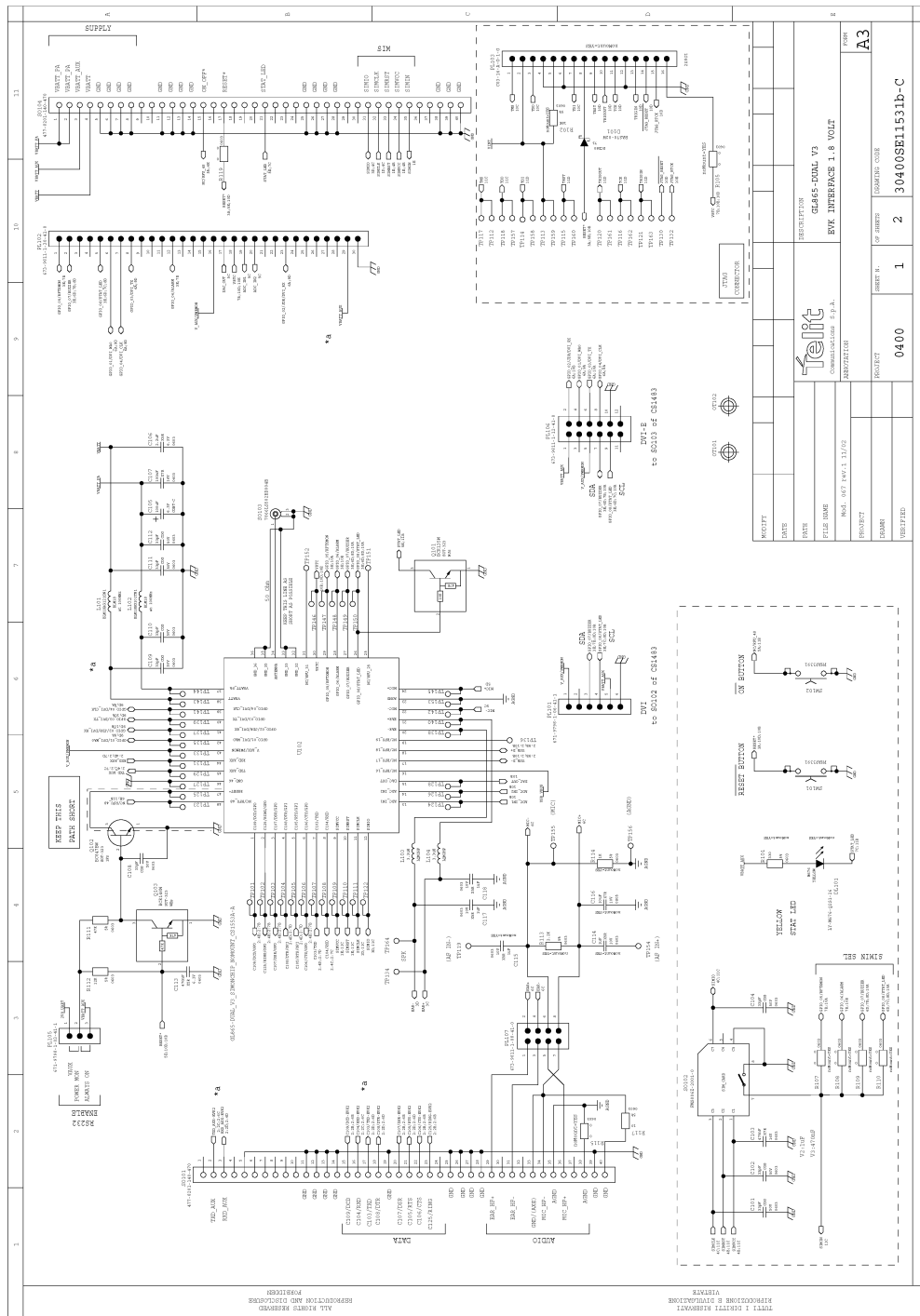

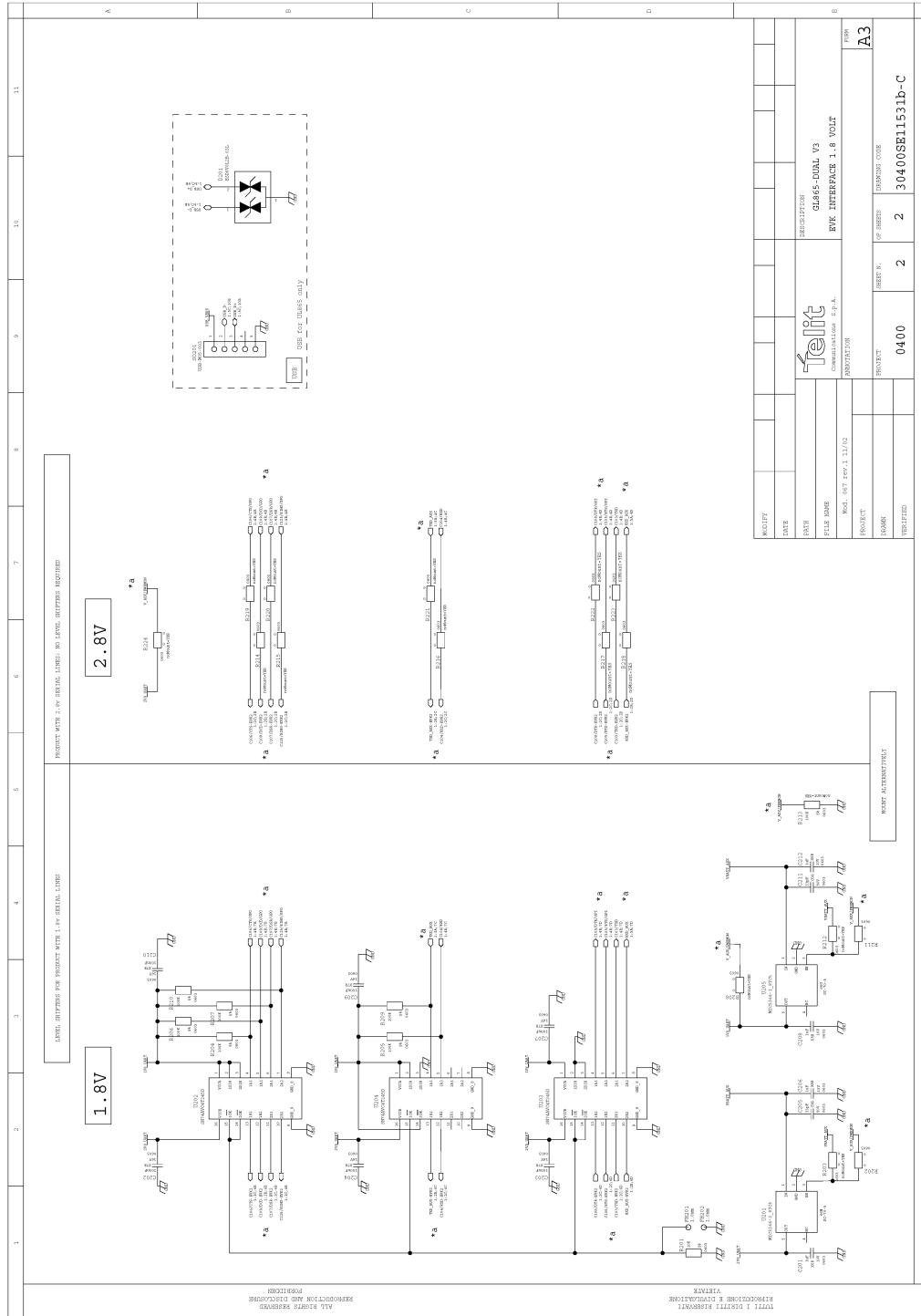

43.23. LE920 Interface board

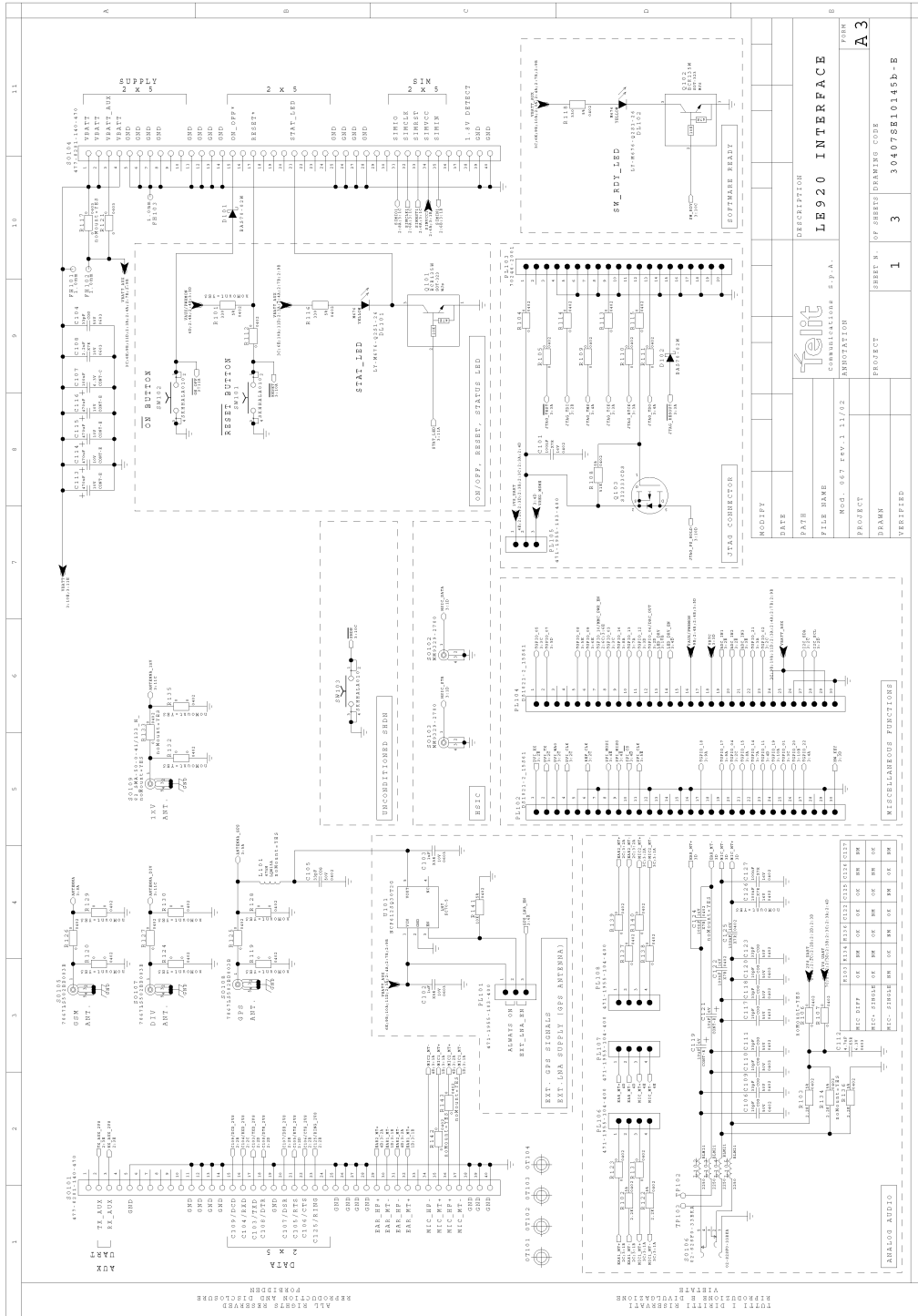

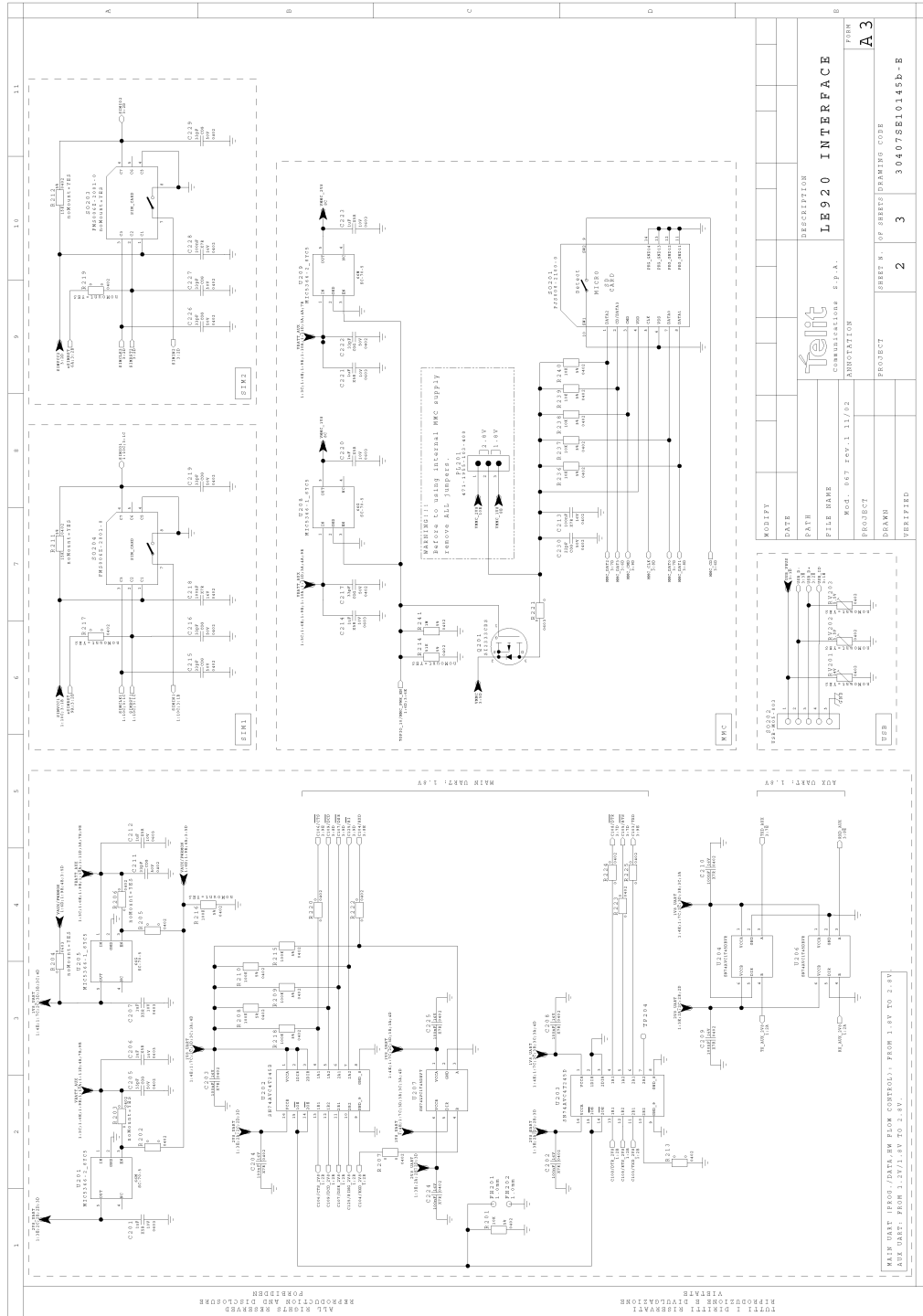

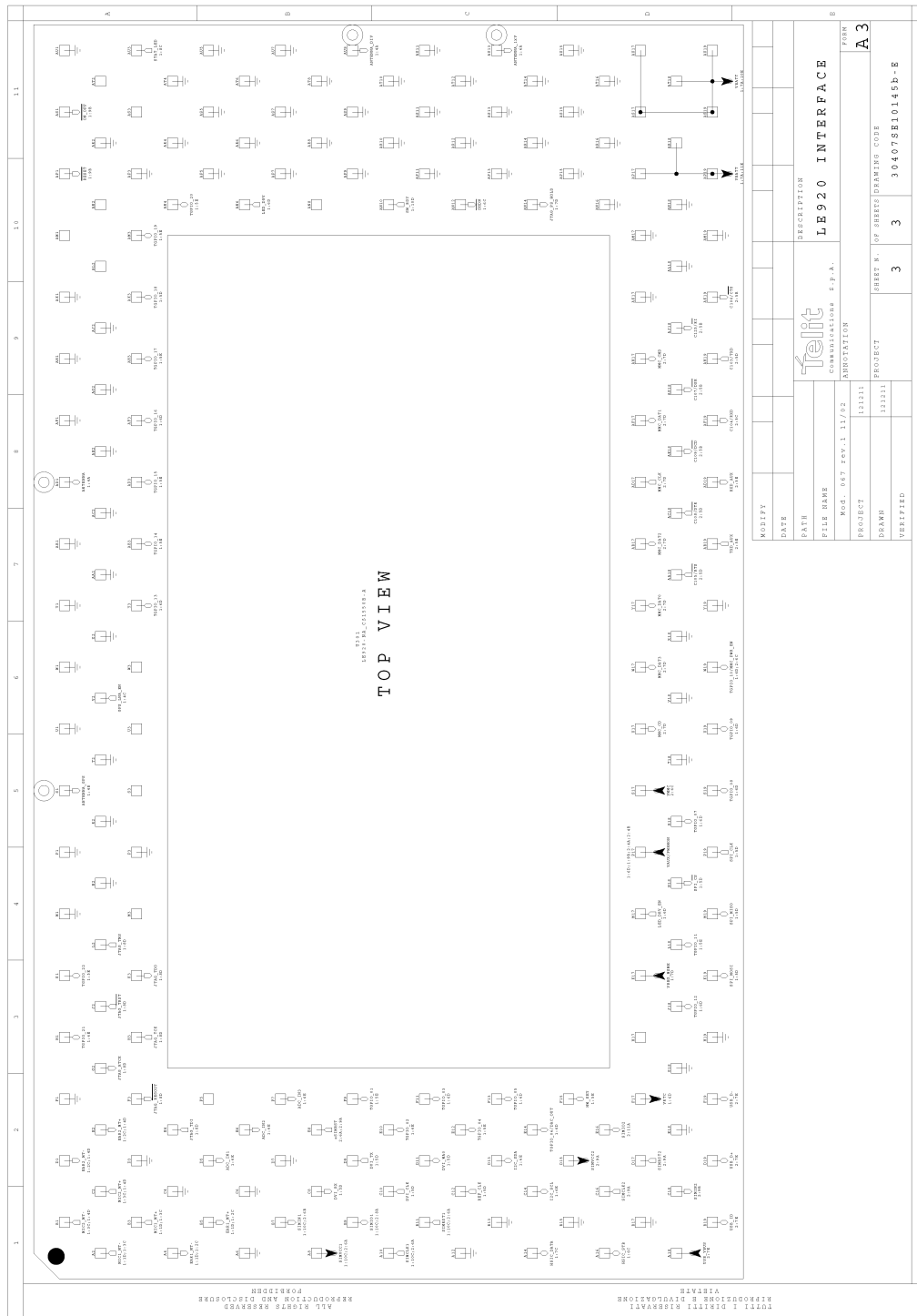

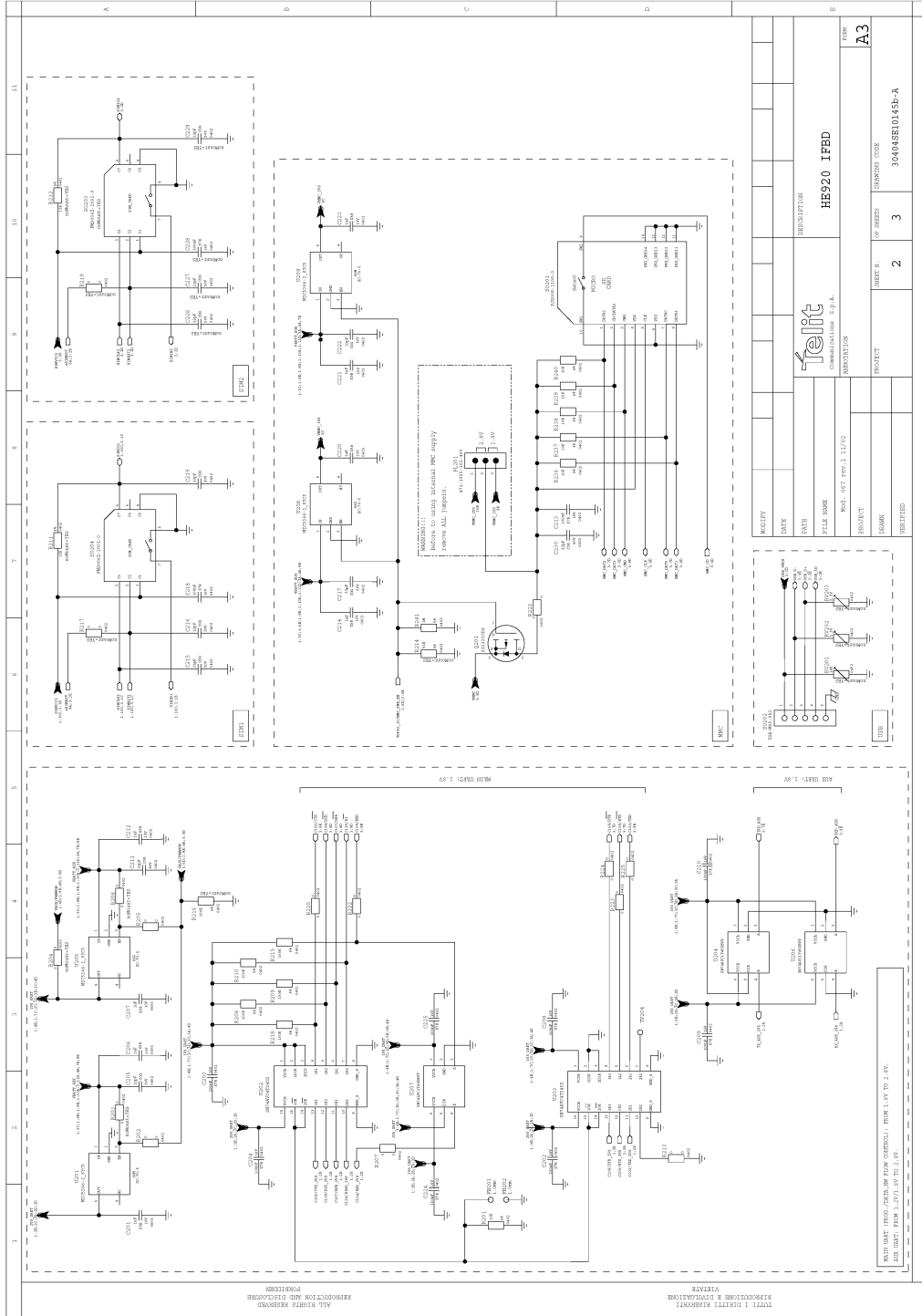

MODIFY	DESCRIPTION	DATE	BY	HE920 IPED
FILE NAME	COMPILATION	PROJECT	300408E0145B-A	
PROJECT	REV. 001	REV. 001	REV. 001	REV. 001
DATE	DATE	DATE	DATE	DATE
TIME	TIME	TIME	TIME	TIME



Telit EVK2 User Guide
1w0300704 Rev.18 – 2014/06/30

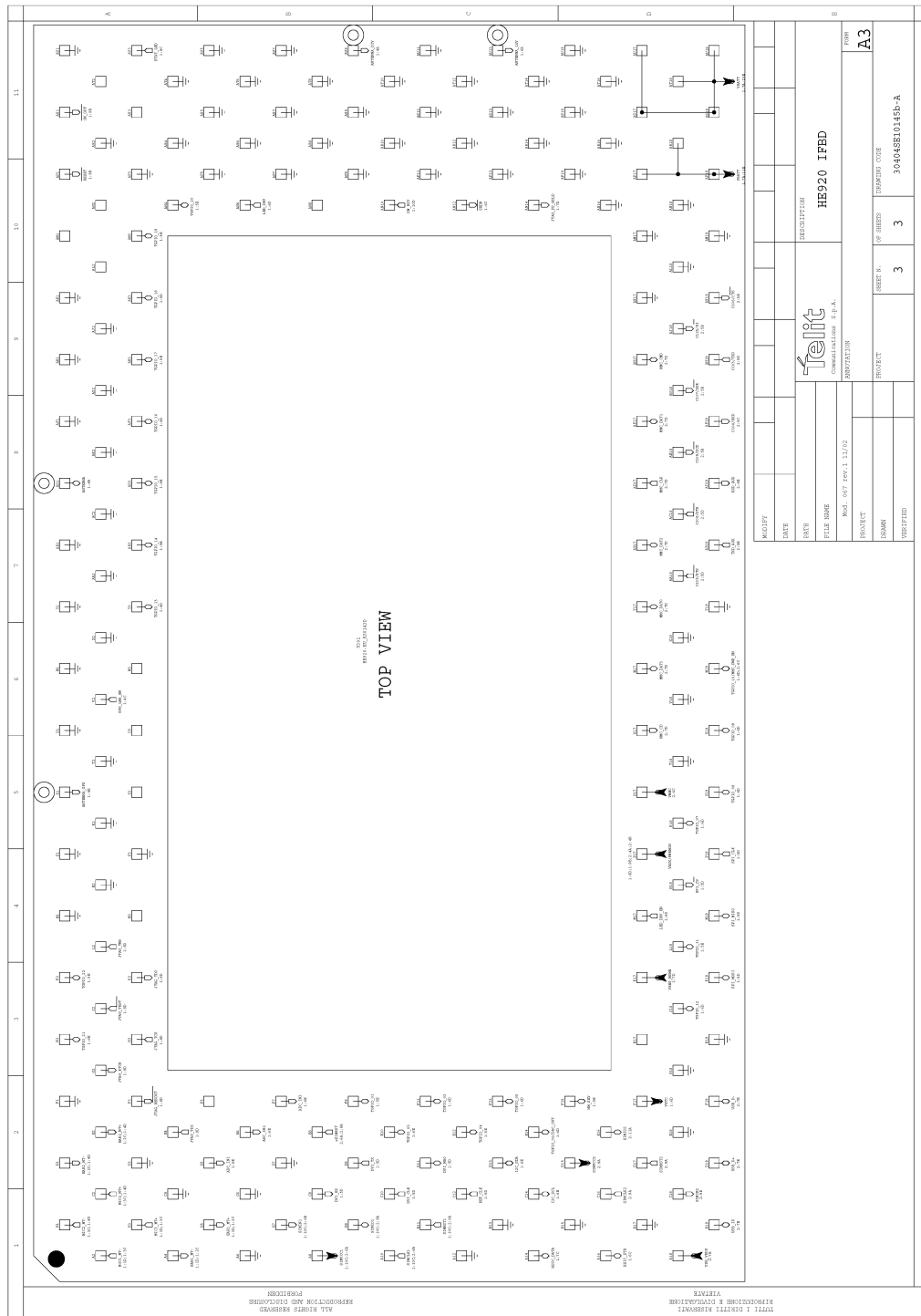

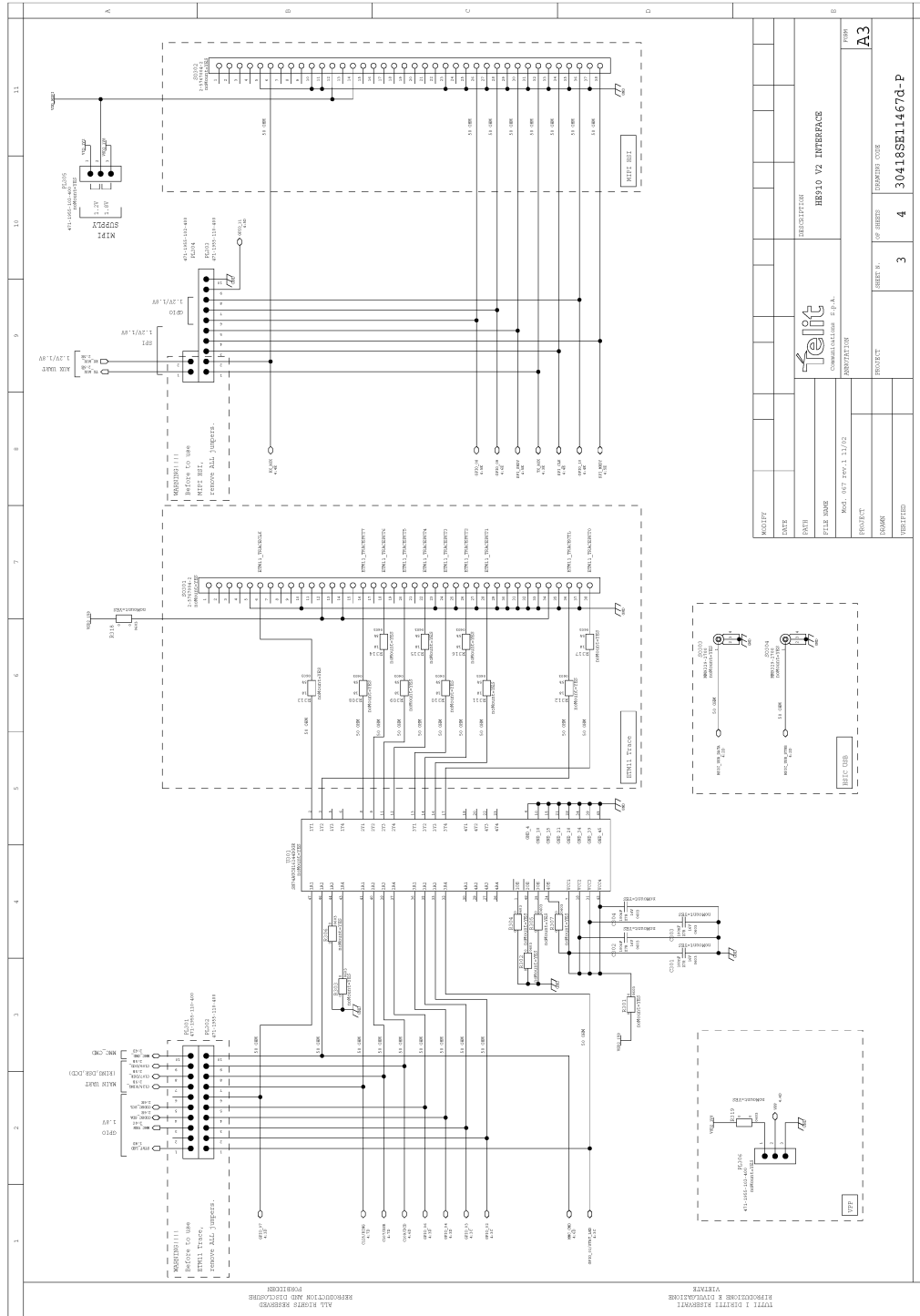

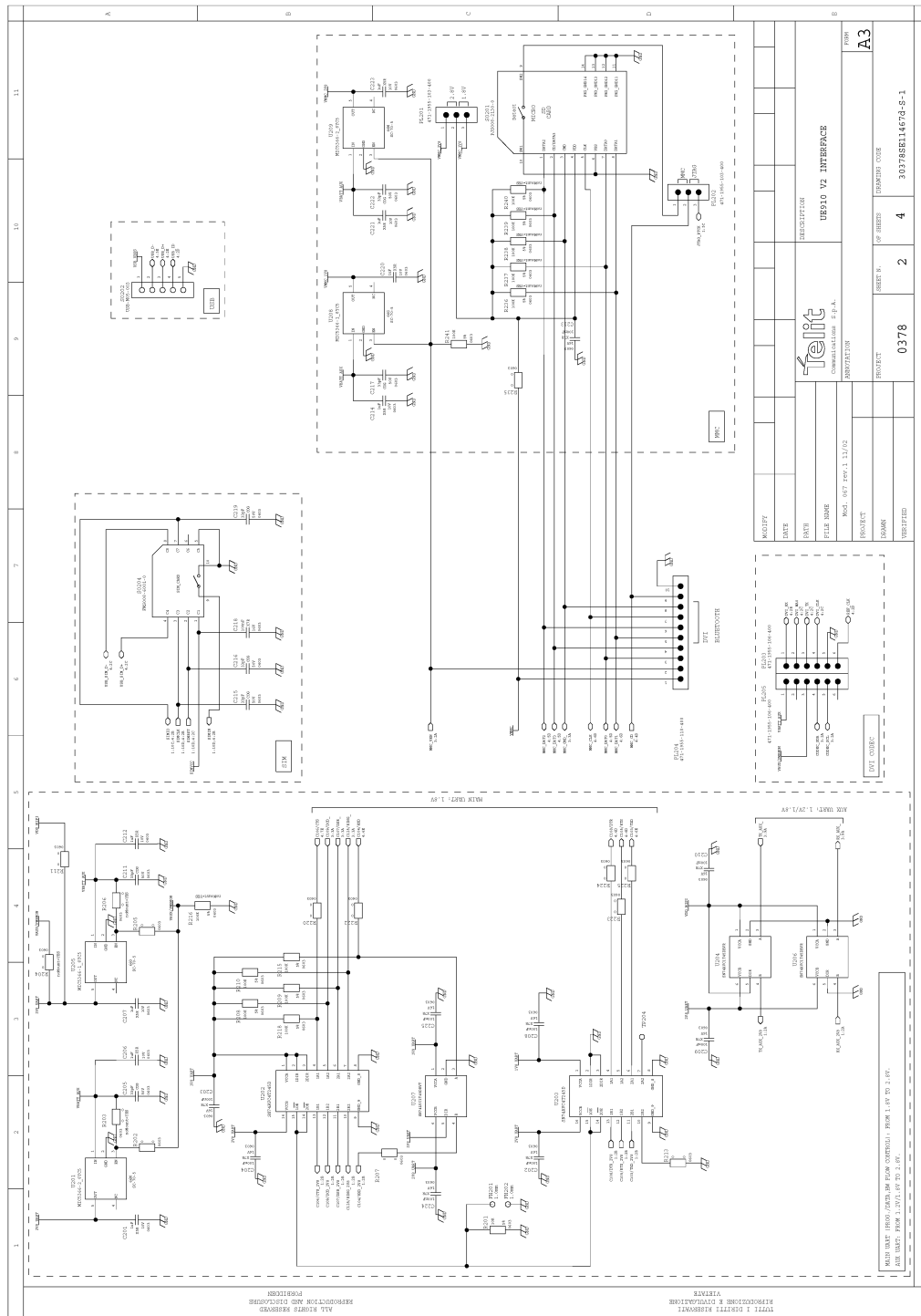

Telit EVK2 User Guide
1w0300704 Rev.18 – 2014/06/30

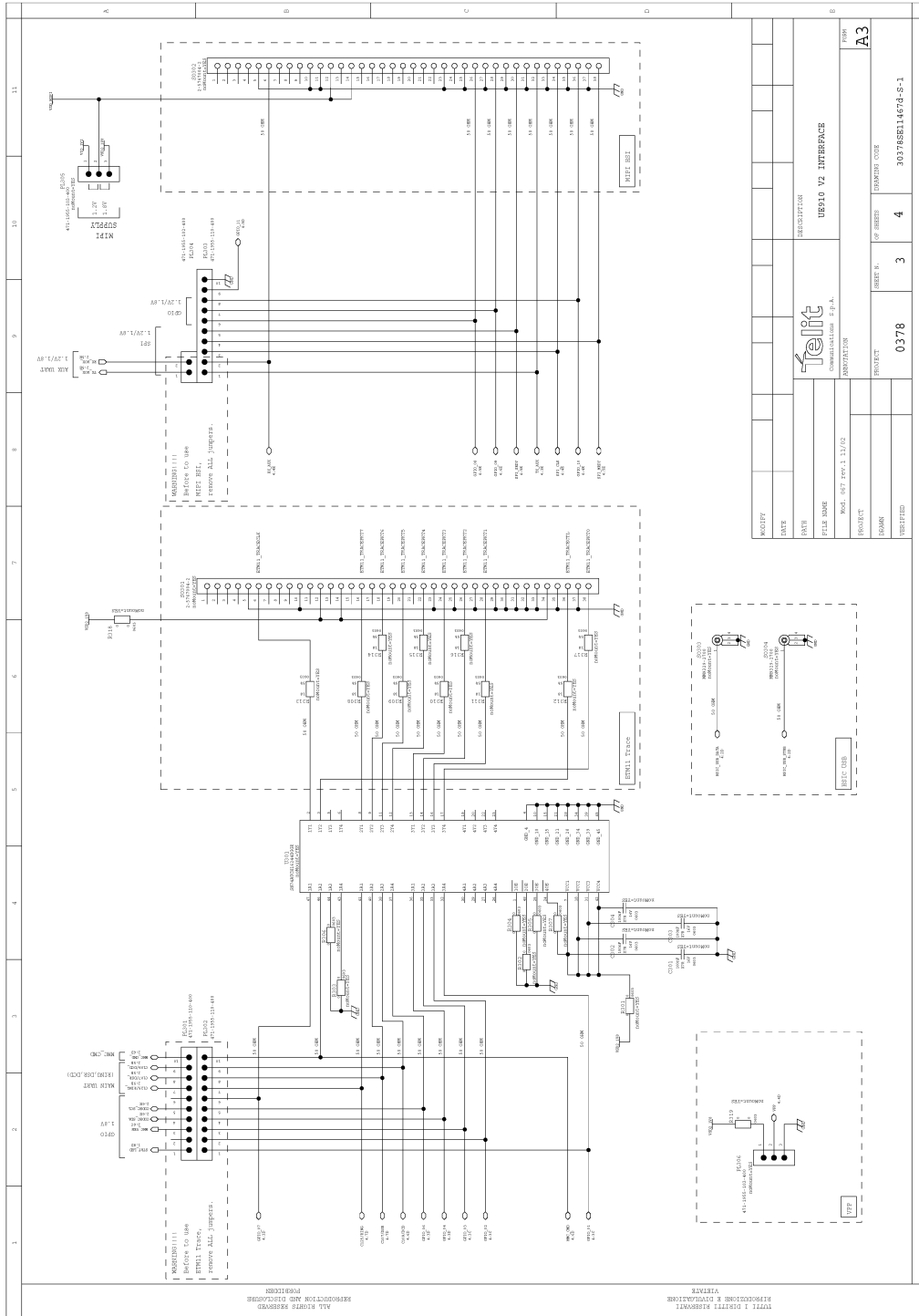

43.28. GE866-QUAD Interface board

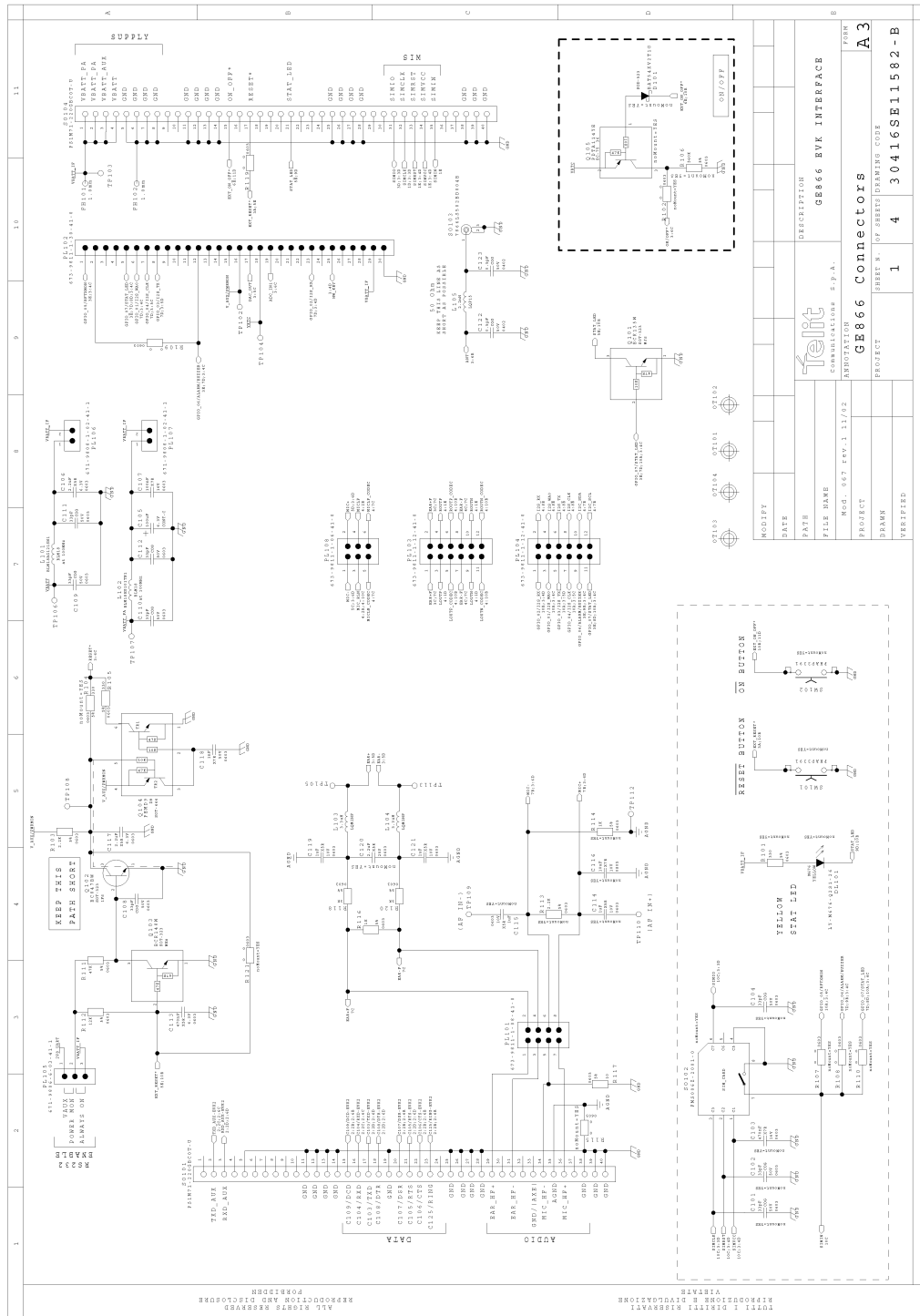

43.29. LE910 Interface board

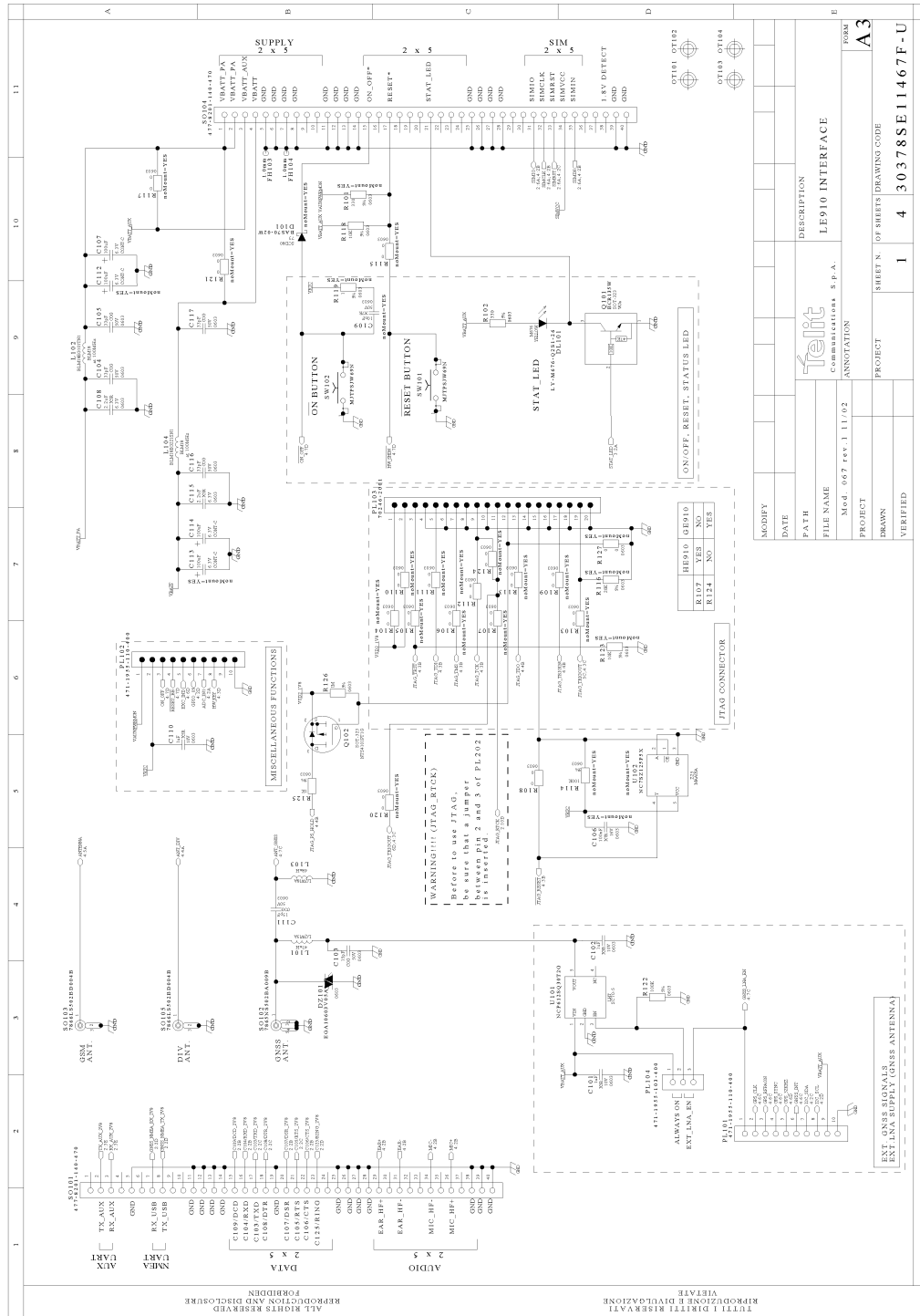

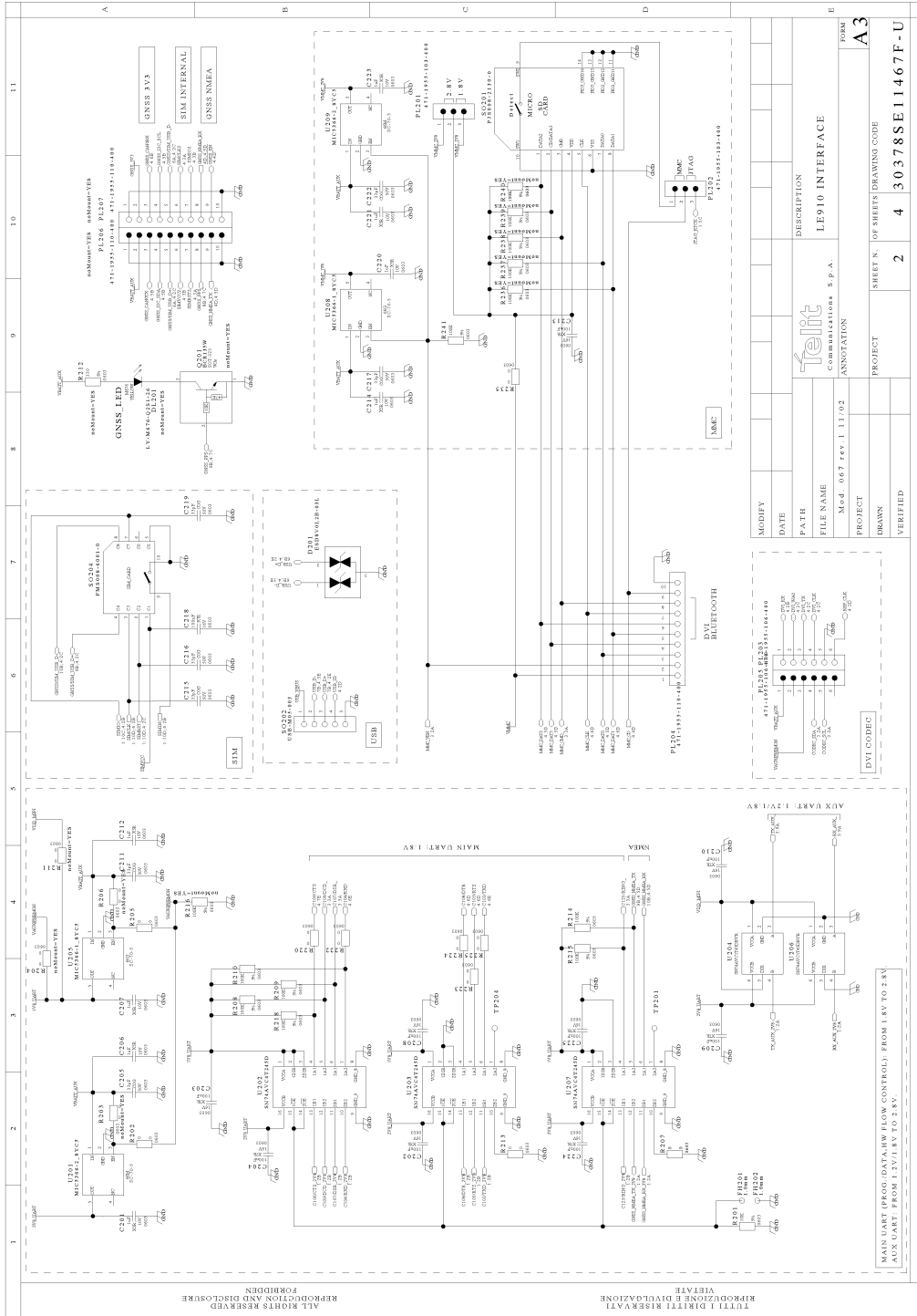

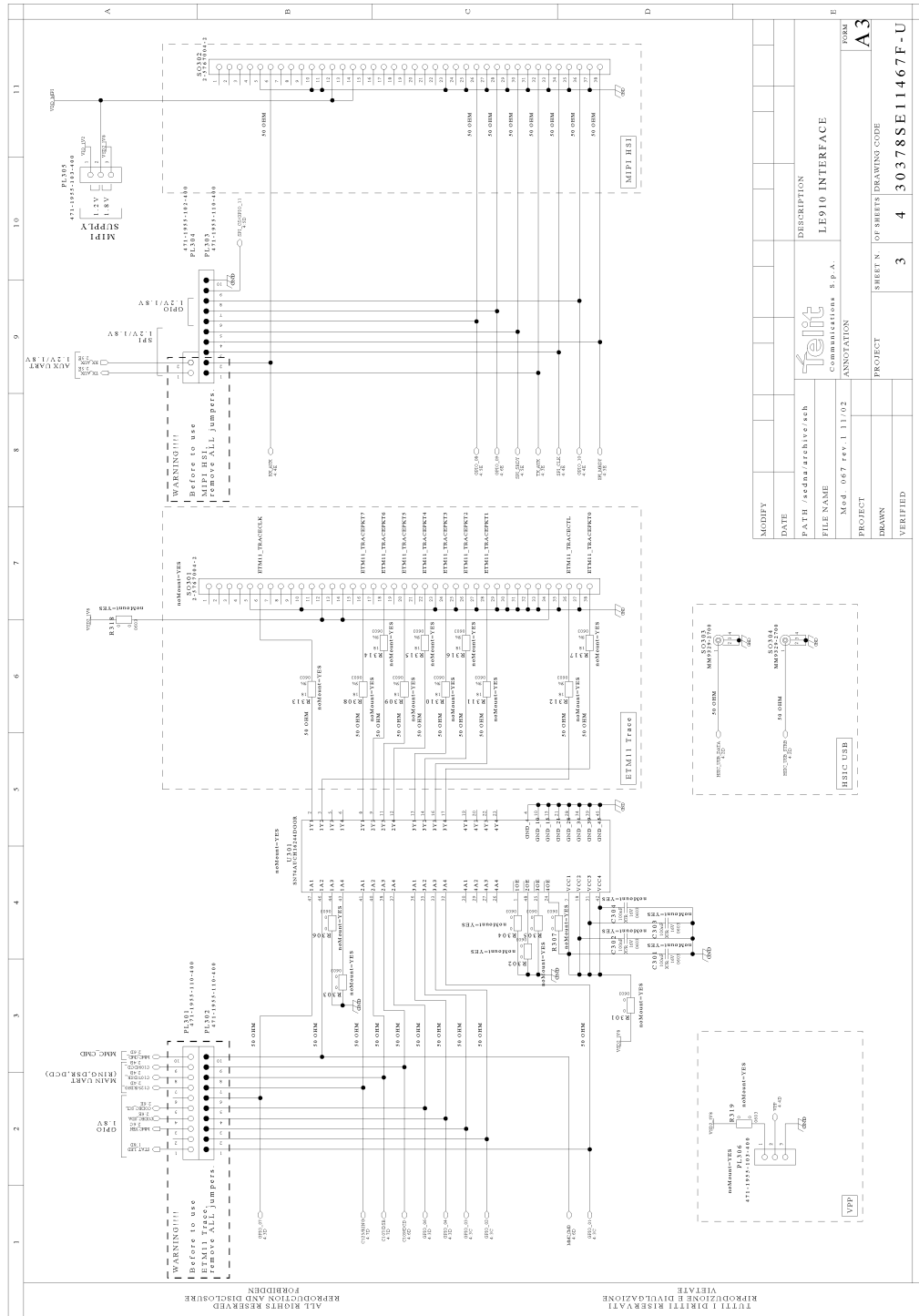

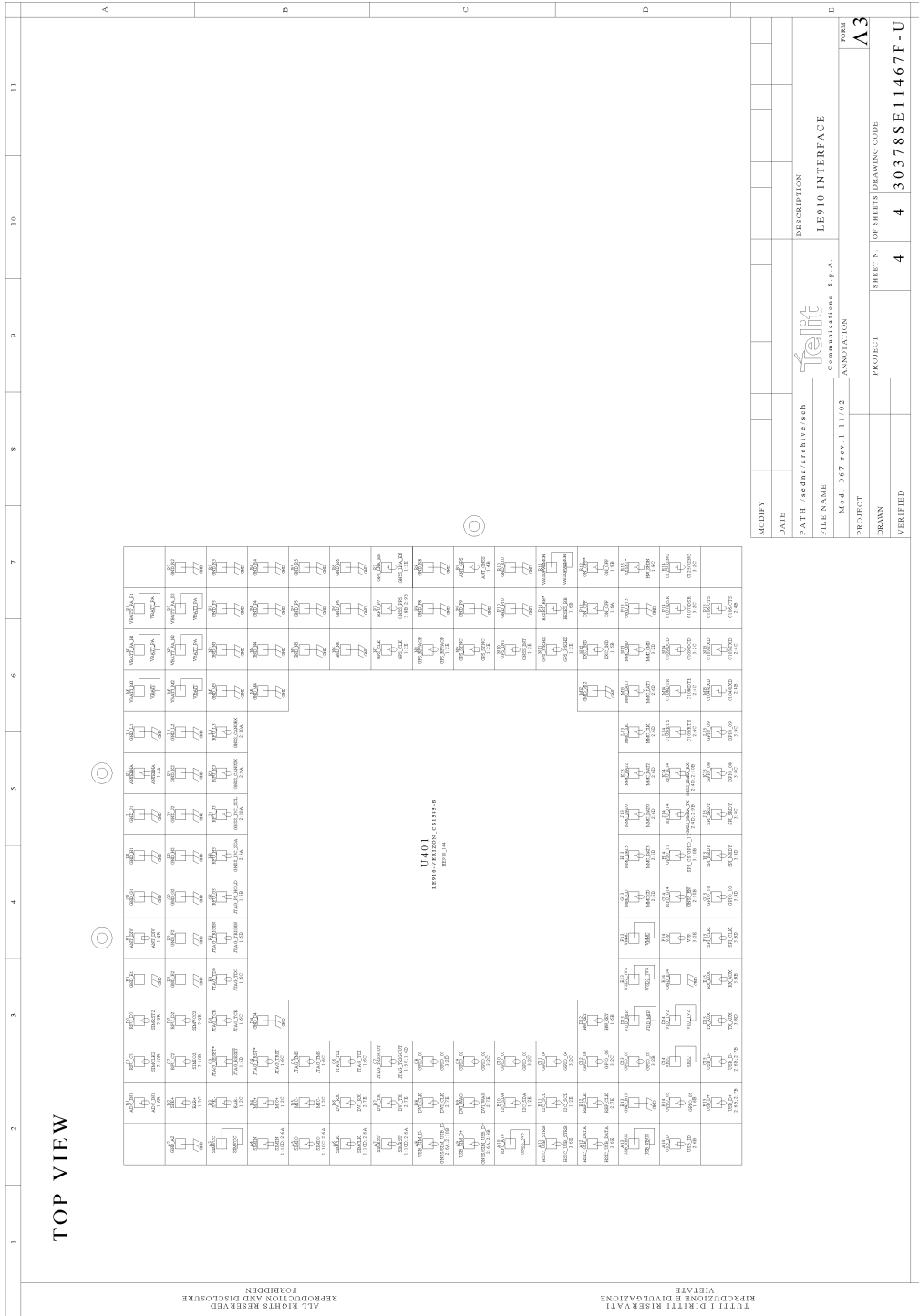

43.30. UL865 Interface board

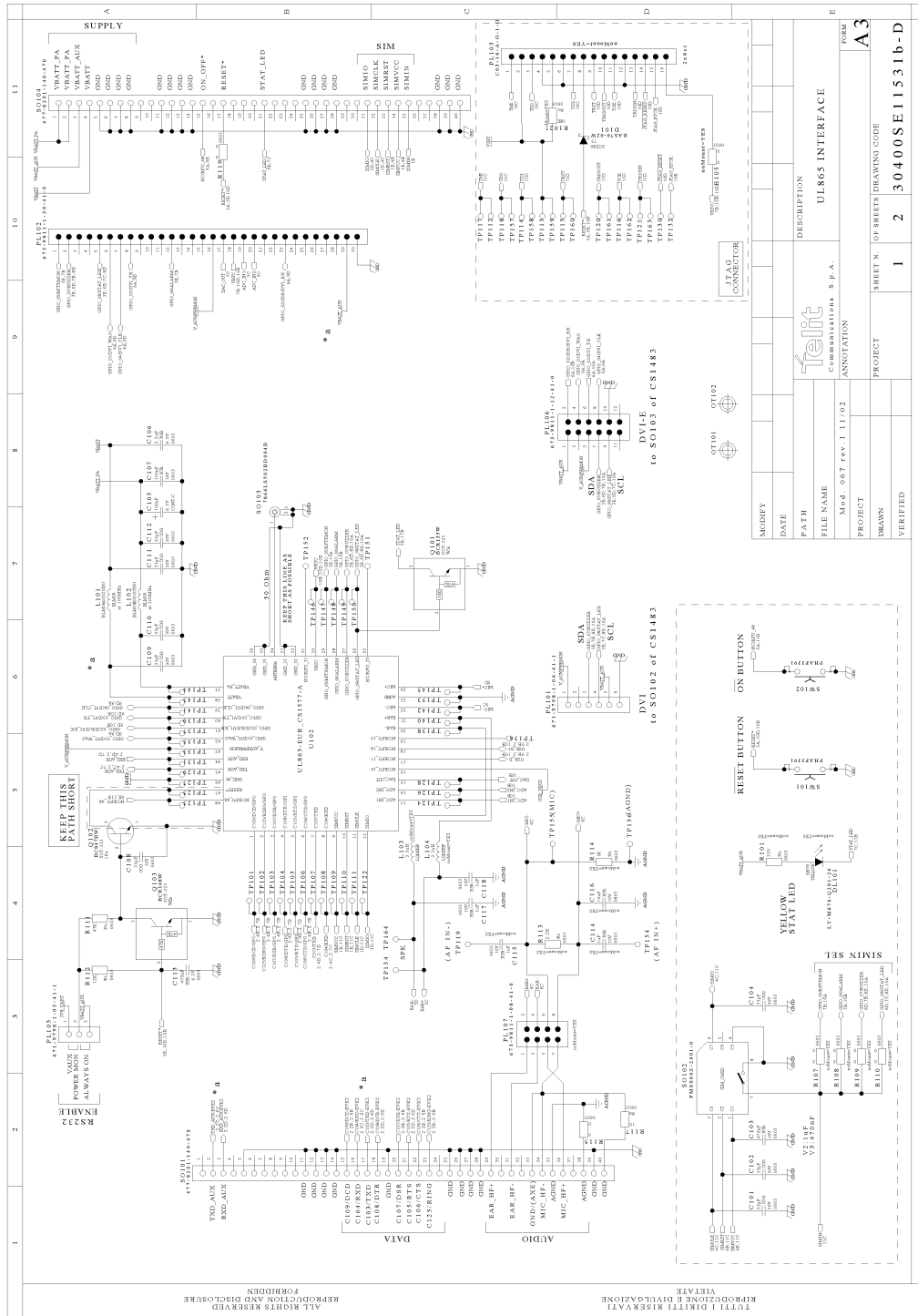

44. Service and firmware update

You can update the Telit Module firmware through the serial cables (RS232 or USB depending on module's characteristics) used for the communication with a PC. The firmware update can be done with a specific software tool provided by Telit that runs on windows based PCs.

All levels are conformed to RS232 and V.24 standard and a PC serial port can be directly connected to this connector.



45.1. Disposal of this product in the European Union

According to the WEEE Directive 2012/19/EU, the crossed-out wheeled bin symbol on the product or on its packaging indicates that the product must not be disposed of with your other household waste.



For equipment in private household, it's user's responsibility to dispose of his waste equipment by handing it over to a designated collection point for the recycling of waste electrical and electronic equipment. For more information about where you can drop off your waste equipment from private household for recycling, please contact your local city office, your household waste disposal service or the retailer where you purchased the product. As a producer of electronic devices, TELIT provides for the financing of the treatment and recycling of waste returned through the designated collection points in accordance with local requirements. If you have professional electronic equipment that you purchased directly from TELIT that you wish to have picked up for recycling, please contact us to receive necessary information and instructions. The separate collection and recycling of your waste equipment at the time of disposal will help to conserve natural resources and ensure that it is recycled in a manner that protects human health and the environment.

Reference Directives:

2012/19/EU	Directive of the European Parliament and of the Council of 4 July 2012 on waste electrical and electronic equipment (WEEE).
------------	---

45.2. Disposal of this product in other countries outside the European Union

Please dispose of this product in accordance with local requirements; contact your local authorities or dealer and ask for the correct method of disposal.



Rev.5	13/10/2006	<p>Renamed figure from 38 to 42</p> <p>Pag.2 Added products name and P/N for GE863-PY/QUAD interface and GC864-C2 interface</p> <p>3.2.6 Added mechanical characteristics GC864-C2 interface</p> <p>5.0 Correct Optically Positioning Guide system description</p> <p>7.1 Correct the line selection description</p> <p>6.5.2 Updated Current Charger footnote</p> <p>Generality: added note for the VGA camera</p> <p>Added in the Cross List GE864-PY/QUAD interface and GC864-C2 interface</p> <p>15.2.1 Inserted P/N of GE863-GPS version</p> <p>Added GC864-C2 interface description</p> <p>20.1 Corrected GPIO location and added p/n of GM862 interface</p> <p>20.2 Corrected GPIO location and added p/n of GE863-GPS interface</p> <p>Corrected GPIO location and added p/n of GE863 interface</p> <p>Corrected GPIO location and added p/n of GE864 interface</p> <p>Corrected GPIO location and added p/n of GC864 interface</p> <p>Corrected GPIO location and added p/n of GC864-C2 interface</p> <p>Added GC864-C2 interface Schematic</p> <p>GM862 Interface p/n 3990250670: added RoHS certification</p> <p>GE863-PY Interface p/n 3990250669: added RoHS certification</p> <p>GE863-GPS Interface p/n 3990250671: added RoHS certification</p> <p>GE863-PY Interface p/n 3990250684: added RoHS certification</p> <p>GC864-QUAD Interface p/n 3990250685: added RoHS certification</p> <p>GE864-PY Interface p/n 3990250672: added RoHS certification</p> <p>GC864-PY Interface p/n 3990250680: added RoHS certification</p>
Rev.6	24/05/2007	<p>Pag. 2 Product Table updated</p> <p>Pag. 10 Table 1 updated</p> <p>Pag.24 Modified the formula</p> <p>Pag.22 Inserted the Audio Section chapter</p> <p>Pag.39 Table 10 modified</p> <p>PCB release updating</p> <p>Erased all Dual Camera paragraph</p> <p>Figures and table updated</p> <p>Paragraph 15.3 16.2 17.3 18.3 19.3 inserted</p> <p>24.1 EVK2 SYS p/n 3990150463: added RoHS certification</p> <p>24.9 GE864-QUAD Interface p/n 3990250688: added RoHS certification</p> <p>24.11 GE864-QUAD-C2 Interface p/n 3990250683: added RoHS certification</p>



X-ON Electronics

Largest Supplier of Electrical and Electronic Components

Click to view similar products for [telit](#) manufacturer:

Other Similar products are found below :

[3990251013](#) [700-0084](#) [700-0088](#) [HEPCHDAT204T701](#) [LE910C1N506T0S1000](#) [HE910NAR206T701](#) [HE910GPS206T701](#)
[LEPCIC1N502T7A6000](#) [HE910NAD206T701](#)