

# Telit EVK2 User Guide

1w0300704 Rev.19 – 2015/01/26



**APPLICABILITY LIST:**



Model	Part Number	Engine
EVK2	3990150474	Mother Board
EVK2-M2MAIR	3990150502	Mother Board + m2mAIR SIM
GM862 INTERFACE	3990250670	GM862
GE863-PY INTERFACE	3990250684	GE863-PY
GE863-GPS INTERFACE	3990250696	GE863-GPS
GE863-SIM INTERFACE	3990250703	GE863-SIM
GE864-PY INTERFACE	3990250672	GE864-PY
GE864-QUAD V2 INTERFACE	3990250777	GE864-QUAD V2
GE864-DUAL V2 INTERFACE	3990250778	GE864-DUAL V2
GE864-QUAD AUTOMOTIVE V2 INTERFACE	3990250773	GE864-QUAD AUTOMOTIVE V2
GE864-QUAD ATEX V2 INTERFACE	3990250772	GE864-QUAD ATEX V2
GE864-QUAD SIM V2 INTERFACE	3990250771	GE864-QUAD SIM V2
GE864-GPS INTERFACE	3990250820	
	3990250821	GE864-GPS
	3990250822	
GC864 INTERFACE	3990250680	GC864
GC864-QUAD-C2 INTERFACE	3990250683	GC864-QUAD-C2
GE865-QUAD INTERFACE	3990250766	GE865-QUAD
GE865/SE867-AGPS INTERFACE	3990250814	GE865-QUAD
GE865/JF2 INTERFACE	3990250868	GE865-QUAD
GL865/JN3 INTERFACE	3990250954	GL865-QUAD
GL865-QUAD INTERFACE	3990250812	GL865-QUAD
GL865-DUAL INTERFACE	3990250783	GL865-DUAL
GL868-DUAL INTERFACE	3990250790	GL868-DUAL
UC864 INTERFACE	4990150470	UC864
HE863-EUR INTERFACE	3990250797	HE863
HE863-EUG INTERFACE	3990250798	HE863





HE863-NAD INTERFACE	3990250799	HE863
HE863-NAR INTERFACE	3990250800	HE863
HE863-NAG INTERFACE	3990250801	HE863
HE863-AUR INTERFACE	3990250803	HE863
HE863-AUG INTERFACE	3990250804	HE863
HE910 INTERFACE	3990250845	HE910
UE910-EUR INTERFACE	3990250918	UE910-EUR
UE910-NAR INTERFACE	3990250919	UE910-NAR
UE910-N3G INTERFACE	3990251140	UE910-N3G
GE910 INTERFACE	3990250882	GE910
GE910-GNSS INTERFACE	3990250941	GE910-GNSS
GE910-QUAD V3 INTERFACE	3990251006	GE910-QUAD V3
DE910 INTERFACE	3990250886	DE910
CE910 INTERFACE	3990250887	CE910
GL865-DUAL V3 1.8V INTERFACE	3990250948	GL865-DUAL V3
LE920-EU INTERFACE	3990251000	LE920-EU
LE920-NA INTERFACE	3990250999	LE920-NA
HE920-EU INTERFACE	3990250966	HE920-EU
HE920-NA INTERFACE	3990250967	HE920-NA
HE910 V2-EUG INTERFACE	3990250977	HE910 V2-EUG
HE910 V2-NAG INTERFACE	3990250978	HE910 V2-NAG
UE910-EU V2 INTERFACE	3990250989	UE910-EU V2
UE910-NA V2 INTERFACE	3990250988	UE910_NA V2
CL865-DUAL INTERFACE	3990251051	CL865-DUAL
GE866-QUAD INTERFACE	3990251119	GE866-QUAD
UE866-N3G INTERFACE	3990251092	UE866-N3G
UL865-EUR INTERFACE	3990250961	UL865-EUR
UL865-NAR INTERFACE	3990250962	UL865-NAR
LE910-NAG INTERFACE	3990251036	LE910-NAG
LE910-NVG INTERFACE	3990251037	LE910-NVG
LE910-SVG INTERFACE	3990251087	LE910-SVG
LE910-EUG INTERFACE	3990251061	LE910-EUG



***SPECIFICATIONS SUBJECT TO CHANGE WITHOUT NOTICE***

**Notice**

While reasonable efforts have been made to assure the accuracy of this document, Telit assumes no liability resulting from any inaccuracies or omissions in this document, or from use of the information obtained herein. The information in this document has been carefully checked and is believed to be entirely reliable. However, no responsibility is assumed for inaccuracies or omissions. Telit reserves the right to make changes to any products described herein and reserves the right to revise this document and to make changes from time to time in content hereof with no obligation to notify any person of revisions or changes. Telit does not assume any liability arising out of the application or use of any product, software, or circuit described herein; neither does it convey license under its patent rights or the rights of others.

It is possible that this publication may contain references to, or information about Telit products (machines and programs), programming, or services that are not announced in your country. Such references or information must not be construed to mean that Telit intends to announce such Telit products, programming, or services in your country.

**Copyrights**

This instruction manual and the Telit products described in this instruction manual may be, include or describe copyrighted Telit material, such as computer programs stored in semiconductor memories or other media. Laws in the Italy and other countries preserve for Telit and its licensors certain exclusive rights for copyrighted material, including the exclusive right to copy, reproduce in any form, distribute and make derivative works of the copyrighted material. Accordingly, any copyrighted material of Telit and its licensors contained herein or in the Telit products described in this instruction manual may not be copied, reproduced, distributed, merged or modified in any manner without the express written permission of Telit. Furthermore, the purchase of Telit products shall not be deemed to grant either directly or by implication, estoppel, or otherwise, any license under the copyrights, patents or patent applications of Telit, as arises by operation of law in the sale of a product.

**Computer Software Copyrights**

The Telit and 3<sup>rd</sup> Party supplied Software (SW) products described in this instruction manual may include copyrighted Telit and other 3<sup>rd</sup> Party supplied computer programs stored in semiconductor memories or other media. Laws in the Italy and other countries preserve for Telit and other 3<sup>rd</sup> Party supplied SW certain exclusive rights for copyrighted computer programs, including the exclusive right to copy or reproduce in any form the copyrighted computer program. Accordingly, any copyrighted Telit or other 3<sup>rd</sup> Party supplied SW computer programs contained in the Telit products described in this instruction manual may not be copied (reverse engineered) or reproduced in any manner without the express written permission of Telit or the 3<sup>rd</sup> Party SW supplier. Furthermore, the purchase of Telit products shall not be deemed to grant either directly or by implication, estoppel, or otherwise, any license under the copyrights, patents or patent applications of Telit or other 3<sup>rd</sup> Party



supplied SW, except for the normal non-exclusive, royalty free license to use that arises by operation of law in the sale of a product.

## **Usage and Disclosure Restrictions**

### **License Agreements**

The software described in this document is the property of Telit and its licensors. It is furnished by express license agreement only and may be used only in accordance with the terms of such an agreement.

### **Copyrighted Materials**

Software and documentation are copyrighted materials. Making unauthorized copies is prohibited by law. No part of the software or documentation may be reproduced, transmitted, transcribed, stored in a retrieval system, or translated into any language or computer language, in any form or by any means, without prior written permission of Telit

### **High Risk Materials**

Components, units, or third-party products used in the product described herein are NOT fault-tolerant and are NOT designed, manufactured, or intended for use as on-line control equipment in the following hazardous environments requiring fail-safe controls: the operation of Nuclear Facilities, Aircraft Navigation or Aircraft Communication Systems, Air Traffic Control, Life Support, or Weapons Systems (High Risk Activities<sup>TM</sup>). Telit and its supplier(s) specifically disclaim any expressed or implied warranty of fitness for such High Risk Activities.

### **Trademarks**

TELIT and the Stylized T Logo are registered in Trademark Office. All other product or service names are the property of their respective owners.

Copyright © Telit Communications S.p.A.



## Contents

<b>1. Introduction.....</b>	<b>18</b>
1.1. Scope.....	18
1.2. Audience.....	18
1.3. Contact Information, Support.....	18
1.4. Text Conventions.....	19
1.5. Related Documents.....	19
1.6. Content of the kit.....	20
<b>2. Description.....</b>	<b>21</b>
2.1. PCB characteristics .....	22
2.2. Mechanical characteristics of the assembled PCBs.....	23
2.2.1. Mother Board CS1139B .....	23
2.2.2. GM862 Interface CS1150B .....	23
2.2.3. GE863 Interface CS1151A .....	23
2.2.4. GE864 Interface CS1152B .....	23
2.2.5. GE864-GPS Interface CS1439B.....	23
2.2.6. GC864 Interface CS1203B .....	24
2.2.7. GC864-C2 Interface CS1231X.....	24
2.2.8. GE865 Interface CS1324A .....	24
2.2.9. GE865/SE867-AGPS Interface CS1433 .....	24
2.2.10. GE865/JF2 Interface CS1521 .....	24
2.2.11. GL865 Interface CS1431A .....	24
2.2.12. UC864-CC864 Interface KS0101C .....	25
2.2.13. HE910 Interface CS1467C .....	25
2.2.14. UE910 Interface CS1467D .....	25
2.2.15. GE910 Interface CS1467D .....	25
2.2.16. GE910-GNSS Interface CS1467F .....	25
2.2.17. GE910-QUAD V3 Interface CS1467F .....	25
2.2.18. DE910 Interface CS1467D .....	25
2.2.19. CE910 Interface CS1467D .....	25
2.2.20. GL865 V3 Interface CS1531B.....	26
2.2.21. LE920 Interface KS0145B.....	26
2.2.22. HE920 Interface KS0145B .....	26
2.2.23. HE910 V2 Interface CS1467D .....	26
2.2.24. UE910 V2 Interface CS1467D .....	26
2.2.25. CL865 Interface CS1531B.....	26
2.2.26. GE866-QUAD Interface CS1634 .....	26
2.2.27. UE866 Interface CS1634 .....	26
2.2.28. UL865 Interface CS1531B .....	27
2.2.29. LE910 Interface CS1467F .....	27
<b>3. Startup procedure.....</b>	<b>28</b>
<b>4. Insertion of the Interface Boards.....</b>	<b>29</b>
<b>5. Power supply setting .....</b>	<b>30</b>



<b>5.1.</b>	<b>Fixed DC source</b> .....	<b>30</b>
<b>5.2.</b>	<b>Variable DC source</b> .....	<b>31</b>
5.2.1.	Coaxial Plug.....	32
<b>5.3.</b>	<b>Li-Ion Battery pack and Charger</b> .....	<b>32</b>
<b>5.4.</b>	<b>Application Notes</b> .....	<b>33</b>
5.4.1.	Li-Ion Battery Pack.....	33
5.4.2.	About Current Charger .....	33
<b>6.</b>	<b>Serial interface</b> .....	<b>34</b>
<b>6.1.</b>	<b>Serial Port Setup</b> .....	<b>35</b>
<b>7.</b>	<b>Audio Section</b> .....	<b>36</b>
<b>7.1.</b>	<b>Overview</b> .....	<b>36</b>
7.1.1.	History .....	36
<b>7.2.</b>	<b>Actual</b> .....	<b>37</b>
7.2.1.	The choice.....	37
<b>7.3.</b>	<b>Differential and Single Ended</b> .....	<b>37</b>
7.3.1.	Concepts .....	37
7.3.2.	Benefits and disadvantages .....	38
7.3.3.	Settings .....	39
<b>8.</b>	<b>AF Amplifiers Setting</b> .....	<b>40</b>
<b>9.</b>	<b>Audio outputs</b> .....	<b>41</b>
<b>9.1.</b>	<b>Low AF Power Mode</b> .....	<b>41</b>
<b>9.2.</b>	<b>High AF Power Mode</b> .....	<b>42</b>
9.2.1.	Speaker and Stand-alone Microphone .....	43
9.2.2.	Speaker plus Headset .....	44
<b>10.</b>	<b>Audio Accessories</b> .....	<b>45</b>
<b>10.1.</b>	<b>Headset</b> .....	<b>45</b>
<b>10.2.</b>	<b>Stand-alone microphone</b> .....	<b>46</b>
<b>10.3.</b>	<b>Speaker</b> .....	<b>46</b>
<b>11.</b>	<b>Indication and services</b> .....	<b>47</b>
<b>11.1.</b>	<b>Optical Indicators</b> .....	<b>47</b>
11.1.1.	Status Led .....	47
11.1.2.	CHARGE Led.....	48
<b>11.2.</b>	<b>Switches</b> .....	<b>49</b>
11.2.1.	POWER ON Switch.....	49
11.2.2.	RESET Switch .....	49
<b>12.</b>	<b>Connectors pinout</b> .....	<b>50</b>
<b>12.1.</b>	<b>Motherboard to Module</b> .....	<b>50</b>





<b>13.</b>	<b>Module Interface Boards .....</b>	<b>53</b>
<b>13.1.</b>	<b>Generality .....</b>	<b>53</b>
<b>13.2.</b>	<b>Short Description.....</b>	<b>53</b>
<b>13.3.</b>	<b>Further Accessories for GPS version.....</b>	<b>53</b>
<b>14.</b>	<b>GM862 Interface .....</b>	<b>54</b>
<b>14.1.</b>	<b>Stand-alone setup .....</b>	<b>54</b>
<b>14.2.</b>	<b>Interface connectors .....</b>	<b>55</b>
<b>14.3.</b>	<b>Content of the kit.....</b>	<b>55</b>
<b>15.</b>	<b>GE863 Interface.....</b>	<b>56</b>
<b>15.1.</b>	<b>Stand-alone setup .....</b>	<b>56</b>
<b>15.2.</b>	<b>Content of the kits .....</b>	<b>57</b>
15.2.1.	GE863-PY/QUAD version .....	57
15.2.2.	GE863-GPS version.....	57
15.2.3.	GE863-SIM version.....	57
<b>15.3.</b>	<b>Interface connectors .....</b>	<b>57</b>
<b>15.4.</b>	<b>Additional components for GPS version .....</b>	<b>57</b>
<b>15.5.</b>	<b>USB connector .....</b>	<b>58</b>
<b>15.6.</b>	<b>Serial port configuration.....</b>	<b>59</b>
15.6.1.	GE863-PY/QUAD .....	60
15.6.2.	GE863 – GPS.....	60
<b>15.7.</b>	<b>ANTENNA connectors.....</b>	<b>62</b>
15.7.1.	GPS ANTENNA connector .....	62
15.7.2.	GSM ANTENNA connector.....	62
15.7.3.	RFU ANTENNA connector.....	62
<b>16.</b>	<b>GE864 Interface.....</b>	<b>63</b>
<b>16.1.</b>	<b>Stand-alone setup .....</b>	<b>63</b>
<b>16.2.</b>	<b>Interface connectors .....</b>	<b>64</b>
<b>16.3.</b>	<b>Content of the kit.....</b>	<b>64</b>
<b>17.</b>	<b>GE864-GPS Interface .....</b>	<b>65</b>
<b>17.1.</b>	<b>Part numbering.....</b>	<b>65</b>
<b>17.2.</b>	<b>Stand-alone setup .....</b>	<b>66</b>
<b>17.3.</b>	<b>Interface connectors .....</b>	<b>66</b>
<b>17.4.</b>	<b>Contents of the kit .....</b>	<b>66</b>
<b>17.5.</b>	<b>Power supply.....</b>	<b>67</b>
<b>17.6.</b>	<b>GPS external LNA enable signal.....</b>	<b>67</b>



- 17.7. Serial port configuration.....68**
  - 17.7.1. ASC1 to RS-232 .....69
  - 17.7.2. GPS to ASC1 (internal host controlling configuration) .....69
  - 17.7.3. GPS to RS-232 (external host controlling configuration) .....70
  - 17.7.4. GPS to USB .....70
- 17.8. GPIO settings.....71**
  - 17.8.1. Internal host controlling configuration .....71
  - 17.8.2. External host controlling configuration .....72
- 17.9. Antenna connectors.....74**
  - 17.9.1. GSM antenna connector.....74
  - 17.9.2. GPS antenna connector .....74
- 18. GE865 – SE867 AGPS Interface .....75**
  - 18.1. Stand-alone setup .....75**
  - 18.2. Interface connectors .....76**
  - 18.3. Contents of the kit .....76**
  - 18.4. Serial connections .....77**
    - 18.4.1. GSM to GPS (GSM controlling configuration) .....77
    - 18.4.2. GSM to Trace .....78
    - 18.4.3. GPS to Trace(external host controlling configuration) .....79
  - 18.5. Antenna connectors.....79**
    - 18.5.1. GSM antenna connector.....79
    - 18.5.2. GPS antenna connector .....79
- 19. GE865 – JF2 Interface .....80**
  - 19.1. Stand-alone setup .....80**
  - 19.2. Interface connectors .....81**
  - 19.3. Contents of the kit .....81**
  - 19.4. Power supply.....81**
  - 19.5. GPS external LNA enable signal.....82**
  - 19.6. Serial port configuration.....84**
  - 19.7. GSM to Trace.....85**
  - 19.8. GPS to Trace.....85**
  - 19.9. GSM to USB.....86**
  - 19.10. GPS to USB .....86**
  - 19.11. GPS to GSM (internal host controlling configuration).....87**
  - 19.12. GPIO settings.....87**
    - 19.12.1. Internal host controlling configuration .....88
    - 19.12.2. External host controlling configuration .....89
  - 19.13. GPS serial interface setting .....90**



<b>19.14. MEMS Sensor/EEPROM Interface</b> .....	<b>90</b>
<b>19.15. GPS power-on management</b> .....	<b>90</b>
<b>19.16. Antenna connectors</b> .....	<b>91</b>
19.16.1. GSM antenna connector.....	91
19.16.2. GPS antenna connector.....	91
<b>20. GL865 – SL869/JN3 Interface</b> .....	<b>92</b>
<b>20.1. Stand-alone setup</b> .....	<b>93</b>
<b>20.2. Interface connectors</b> .....	<b>93</b>
<b>20.3. Contents of the kit</b> .....	<b>93</b>
<b>20.1. Power supply</b> .....	<b>94</b>
<b>20.2. GPS external LNA enable signal</b> .....	<b>95</b>
<b>20.3. Serial port configuration</b> .....	<b>96</b>
<b>20.4. GSM to Trace</b> .....	<b>97</b>
<b>20.5. GPS to Trace</b> .....	<b>97</b>
<b>20.6. GSM to USB</b> .....	<b>98</b>
<b>20.7. GPS to USB</b> .....	<b>98</b>
<b>20.8. GPS to GSM (internal host controlling configuration)</b> .....	<b>99</b>
<b>20.9. GPIO settings</b> .....	<b>100</b>
20.9.1. Internal host controlling configuration.....	100
20.9.2. External host controlling configuration.....	101
<b>20.10. Antenna connectors</b> .....	<b>102</b>
20.10.1. GSM antenna connector.....	102
20.10.2. GPS antenna connector.....	102
<b>21. GC864 Interface</b> .....	<b>103</b>
<b>21.1. Stand-alone setup</b> .....	<b>103</b>
<b>21.2. Interface connectors</b> .....	<b>104</b>
<b>21.3. Content of the kit</b> .....	<b>104</b>
<b>22. GC864-C2 family Interface</b> .....	<b>105</b>
<b>22.1. Stand-alone setup</b> .....	<b>105</b>
<b>22.2. Interface connectors</b> .....	<b>106</b>
<b>22.3. Content of the kit</b> .....	<b>106</b>
<b>23. GE865 Interface</b> .....	<b>107</b>
<b>23.1. Stand-alone setup</b> .....	<b>107</b>
<b>23.2. Interface connectors</b> .....	<b>108</b>



<b>23.3.</b>	<b>Content of the kit.....</b>	<b>108</b>
<b>24.</b>	<b>GL865 Interface.....</b>	<b>109</b>
<b>24.1.</b>	<b>Stand-alone setup .....</b>	<b>109</b>
<b>24.2.</b>	<b>Interface connectors .....</b>	<b>110</b>
<b>24.3.</b>	<b>Content of the kit.....</b>	<b>110</b>
<b>25.</b>	<b>UC864 family Interface.....</b>	<b>111</b>
<b>25.1.</b>	<b>Stand-alone setup .....</b>	<b>111</b>
<b>25.2.</b>	<b>Interface connectors .....</b>	<b>112</b>
<b>25.3.</b>	<b>Content of the kit.....</b>	<b>112</b>
<b>26.</b>	<b>HE910 family Interface.....</b>	<b>113</b>
<b>26.1.</b>	<b>Stand-alone setup .....</b>	<b>114</b>
<b>26.2.</b>	<b>Interface connectors .....</b>	<b>114</b>
<b>26.3.</b>	<b>Antenna connectors.....</b>	<b>115</b>
26.3.1.	GSM/UMTS Antenna connector .....	115
26.3.2.	Receiver Diversity Antenna connector .....	115
26.3.3.	GPS antenna connector .....	115
<b>26.4.</b>	<b>Expansion Connectors .....</b>	<b>116</b>
26.4.1.	PL301/PL302.....	116
26.4.2.	PL303/PL304/PL305 .....	117
26.4.3.	PL102.....	118
26.4.4.	ON_OFF & UNCONDITIONAL SHUTDOWN BUTTONS .....	118
<b>26.5.</b>	<b>Content of the kit.....</b>	<b>118</b>
<b>27.</b>	<b>UE910 family Interface.....</b>	<b>119</b>
<b>27.1.</b>	<b>Stand-alone setup .....</b>	<b>120</b>
<b>27.2.</b>	<b>Interface connectors .....</b>	<b>120</b>
27.2.1.	GSM/UMTS Antenna connector .....	121
<b>27.3.</b>	<b>Expansion Connectors .....</b>	<b>121</b>
27.3.1.	PL301/PL302.....	121
27.3.2.	PL303/PL304/PL305 .....	122
27.3.3.	PL102.....	123
27.3.4.	ON_OFF & UNCONDITIONAL SHUTDOWN BUTTONS .....	123
<b>27.4.</b>	<b>Content of the kit.....</b>	<b>123</b>
<b>28.</b>	<b>GE910 Interface.....</b>	<b>124</b>
<b>28.1.</b>	<b>Stand-alone setup .....</b>	<b>125</b>
<b>28.2.</b>	<b>Interface connectors .....</b>	<b>125</b>
<b>28.3.</b>	<b>Antenna connectors.....</b>	<b>126</b>
28.3.1.	GSM/GPRS Antenna connector.....	126



- 28.4. Expansion Connectors .....126**
  - 28.4.1. PL301/PL302 ..... 126
  - 28.4.2. PL303/PL304 ..... 127
  - 28.4.3. PL102..... 127
  - 28.4.4. ON\_OFF & UNCONDITIONAL SHUTDOWN BUTTONS ..... 128
- 28.5. Content of the kit.....128**
- 29. GE910-GNSS Interface..... 129**
  - 29.1. Stand-alone setup .....130**
  - 29.2. Interface connectors .....130**
  - 29.3. Antenna connectors.....131**
    - 29.3.1. GSM/GPRS Antenna connector..... 131
    - 29.3.2. GNSS antenna connector ..... 131
  - 29.4. Expansion Connectors .....132**
    - 29.4.1. PL301/PL302..... 132
    - 29.4.2. PL303/PL304 ..... 133
    - 29.4.3. PL102..... 133
    - 29.4.4. ON\_OFF & UNCONDITIONAL SHUTDOWN BUTTONS ..... 134
  - 29.5. Content of the kit.....134**
- 30. GE910-QUAD V3 Interface..... 135**
  - 30.1. Stand-alone setup .....136**
  - 30.2. Interface connectors .....136**
  - 30.3. Antenna connectors.....137**
    - 30.3.1. GSM/GPRS Antenna connector..... 137
  - 30.4. Expansion Connectors .....137**
    - 30.4.1. PL301/PL302..... 137
    - 30.4.2. PL303/PL304 ..... 138
    - 30.4.3. PL102..... 138
    - 30.4.4. ON\_OFF & UNCONDITIONAL SHUTDOWN BUTTONS ..... 139
  - 30.5. Content of the kit.....139**
- 31. DE910 family Interface ..... 140**
  - 31.1. Stand-alone setup .....141**
  - 31.2. Interface connectors .....141**
  - 31.3. Antenna connectors.....142**
    - 31.3.1. CDMA Antenna connector ..... 142
    - 31.3.2. Receiver Diversity Antenna connector ..... 142
    - 31.3.3. GPS antenna connector ..... 142
  - 31.4. Expansion Connectors .....143**
    - 31.4.1. PL301/PL302..... 143
    - 31.4.2. PL303/PL304/PL305 ..... 144
    - 31.4.3. PL102..... 145
    - 31.4.4. ON\_OFF & UNCONDITIONAL SHUTDOWN BUTTONS ..... 145









<b>39.5. Audio configuration .....</b>	<b>182</b>
39.5.1. PL301.....	182
39.5.2. PL302.....	182
39.5.3. PL304 & PL305 .....	182
39.5.4. PL306 and PL307 .....	184
<b>39.6. Other interface connectors .....</b>	<b>185</b>
39.6.1. PL104 & PL105 (POWER) .....	185
39.6.2. PL103 (SIMIN).....	185
39.6.3. PL202 (AUX UART).....	185
<b>39.7. Content of the kit.....</b>	<b>185</b>
<b>40. UE866 Interface.....</b>	<b>186</b>
<b>40.1. Stand-alone setup .....</b>	<b>187</b>
<b>40.2. Interface connectors .....</b>	<b>187</b>
<b>40.3. Antenna connectors.....</b>	<b>189</b>
40.3.1. Main Antenna connector.....	189
<b>40.4. Expansion Connectors .....</b>	<b>189</b>
40.4.1. PL101.....	189
<b>40.5. Audio configuration .....</b>	<b>190</b>
40.5.1. PL301.....	190
40.5.2. PL302.....	190
40.5.3. PL304 & PL305 .....	191
40.5.4. PL306 and PL307 .....	192
<b>40.6. Other interface connectors .....</b>	<b>193</b>
40.6.1. PL104 & PL105 (POWER) .....	193
40.6.2. PL103 (SIMIN).....	193
40.6.3. PL202 (AUX UART).....	193
<b>40.7. Content of the kit.....</b>	<b>193</b>
<b>41. UL865 Interface.....</b>	<b>194</b>
<b>41.1. Stand-alone setup .....</b>	<b>194</b>
<b>41.2. Interface connectors .....</b>	<b>195</b>
<b>41.3. Antenna connectors.....</b>	<b>196</b>
41.3.1. GSM Antenna connector.....	196
<b>41.4. Expansion Connectors .....</b>	<b>196</b>
41.4.1. PL101.....	196
41.4.2. PL106.....	196
<b>41.5. Content of the kit.....</b>	<b>197</b>
<b>42. LE910 Interface .....</b>	<b>198</b>
<b>42.1. Stand-alone setup .....</b>	<b>199</b>
<b>42.2. Interface connectors .....</b>	<b>199</b>



<b>42.3. Antenna connectors</b> .....	<b>200</b>
42.3.1. GSM/GPRS Antenna connector.....	200
42.3.2. GNSS antenna connector .....	200
<b>42.4. Expansion Connectors</b> .....	<b>201</b>
42.4.1. PL301/PL302.....	201
42.4.2. PL303/PL304.....	202
42.4.3. PL102.....	202
42.4.4. ON_OFF & UNCONDITIONAL SHUTDOWN BUTTONS .....	203
<b>42.5. Content of the kit</b> .....	<b>203</b>
<b>43. GPIO ports</b> .....	<b>204</b>
<b>43.1. GPIO location</b> .....	<b>205</b>
43.1.1. GM862 Interface.....	205
43.1.2. GE863-GPS Interface .....	207
43.1.3. GE863 Interfaces (p/n 3990250684 -3990250685-3990250703) .....	209
43.1.4. GE864 Interface (p/n 3990250672) .....	210
43.1.5. GE864-GPS Interface (p/n 3990250822).....	211
43.1.6. GE865/SE867-AGPS Interface (p/n 3990250814) .....	212
43.1.7. GC864 Interface.....	213
43.1.8. GC864-C2 Interface (p/n 3990250683) .....	214
43.1.9. UC864 Interface.....	215
43.1.10. HE910 Interface .....	216
43.1.11. GE910 Interface .....	218
43.1.12. DE910 Interface .....	220
43.1.13. CE910 Interface .....	222
43.1.14. GL865 V3 Interface .....	224
43.1.15. UL865 Interface .....	226
43.1.16. HE920 Family Interface.....	228
43.1.17. HE910 V2 Interface .....	230
43.1.18. UE910 V2 Interface .....	232
43.1.19. CL865 Interface .....	234
43.1.20. GE866-QUAD Interface .....	235
43.1.21. UE866 Interface.....	236
43.1.22. LE910 Interface .....	237
<b>44. SCHEMATICS</b> .....	<b>239</b>
<b>44.1. EVK2 Mother Board</b> .....	<b>240</b>
<b>44.2. GM862 Interface Board</b> .....	<b>245</b>
<b>44.3. GE863 Interface Board</b> .....	<b>246</b>
<b>44.4. GE864 Interface board</b> .....	<b>248</b>
<b>44.5. GE864 Interface board – Automotive</b> .....	<b>249</b>
<b>44.6. GE864 Interface board – V2</b> .....	<b>250</b>
<b>44.7. GE864-GPS Interface board</b> .....	<b>251</b>
<b>44.8. GE865/SE867-AGPS Interface board</b> .....	<b>253</b>
<b>44.9. GE865 Interface board</b> .....	<b>255</b>



<b>44.10. GL865 Interface board .....</b>	<b>256</b>
<b>44.11. GC864 Interface board .....</b>	<b>257</b>
<b>44.12. GC864-C2 Interface board .....</b>	<b>258</b>
<b>44.13. UC864 Interface board .....</b>	<b>259</b>
<b>44.14. HE910/UE910 Interface board .....</b>	<b>261</b>
<b>44.15. GE910 Interface board .....</b>	<b>265</b>
<b>44.16. GE910-GNSS Interface board.....</b>	<b>269</b>
<b>44.17. GE910-QUAD V3 Interface board.....</b>	<b>273</b>
<b>44.18. GE865 – JF2 Interface board .....</b>	<b>277</b>
<b>44.19. GL865 – SL869/JN3 Interface board.....</b>	<b>280</b>
<b>44.20. DE910 Interface board.....</b>	<b>283</b>
<b>44.21. CE910 Interface board.....</b>	<b>287</b>
<b>44.22. GL865 V3 Interface board.....</b>	<b>291</b>
<b>44.23. LE920 Interface board.....</b>	<b>293</b>
<b>44.24. HE920 family Interface board.....</b>	<b>296</b>
<b>44.25. HE910 V2 Interface board.....</b>	<b>299</b>
<b>44.26. UE910 V2 Interface board.....</b>	<b>303</b>
<b>44.27. CL865 Interface board.....</b>	<b>307</b>
<b>44.28. GE866-QUAD Interface board .....</b>	<b>309</b>
<b>44.29. UE866 Interface Board .....</b>	<b>313</b>
<b>44.30. LE910 Interface board.....</b>	<b>317</b>
<b>44.31. UL865 Interface board.....</b>	<b>321</b>
<b>45. Service and firmware update .....</b>	<b>323</b>
<b>46. SAFETY RECOMMENDATIONS .....</b>	<b>324</b>
<b>46.1. Disposal of this product in the European Union.....</b>	<b>325</b>
<b>46.2. Disposal of this product in other countries outside the European Union.....</b>	<b>325</b>
<b>47. Document History .....</b>	<b>326</b>





# 1. Introduction

## 1.1. Scope

The Aim of this document is the handling description of the *developer's Evaluation KIT* second edition, a laboratory tool named **EVK2**.

## 1.2. Audience

All given information shall be used as a guide and a starting point for properly developing of your product. Obviously this document cannot cover all the hardware solutions and products that may be designed.

## 1.3. Contact Information, Support

For general contact, technical support, to report documentation errors and to order manuals, contact Telit's Technical Support Center (TTSC) at:

[TS-EMEA@telit.com](mailto:TS-EMEA@telit.com)  
[TS-NORTHAMERICA@telit.com](mailto:TS-NORTHAMERICA@telit.com)  
[TS-LATINAMERICA@telit.com](mailto:TS-LATINAMERICA@telit.com)  
[TS-APAC@telit.com](mailto:TS-APAC@telit.com)

Alternatively, use:

<http://www.telit.com/en/products/technical-support-center/contact.php>

For detailed information about where you can buy the Telit modules or for recommendations on accessories and components visit:

<http://www.telit.com>

To register for product news and announcements or for product questions contact Telit's Technical Support Center (TTSC).

Our aim is to make this guide as helpful as possible. Keep us informed of your comments and suggestions for improvements.

Telit appreciates feedback from the users of our information.



## 1.4. Text Conventions



*Danger – This information MUST be followed or catastrophic equipment failure or bodily injury may occur.*



*Caution or Warning – Alerts the user to important points about integrating the module, if these points are not followed, the module and end user equipment may fail or malfunction.*



Tip or Information – Provides advice and suggestions that may be useful when integrating the module.

All dates are in ISO 8601 format, i.e. YYYY-MM-DD.

## 1.5. Related Documents

- AT Commands Reference Guides of the relevant modules



## 1.6. Content of the kit

Please check out the content of your *EVK2* kit; if any of the items is missing, please contact your supplier.

Description	Quantity
EVK2 MOTHERBOARD	1
INFORMATION NOTE	1
2 PIN JUMPER FEMALE CONN	18
ASSEMBLED USB A-B CABLE	1
RED & BLACK CABLE WITH PLUGS	1
GSM-UMTS MAGNETIC ANTENNA CABLE RG174 WITH SMA/M	1

Table 1



GE863-PY Interface Board (upper) fitted on EVK2 Motherboard (lower).



## 2. Description

The motherboard *CS1139B* can be split into several functional blocks depending on the implemented function; the following drawings show a block diagram and the displacement of the main blocks on motherboard.

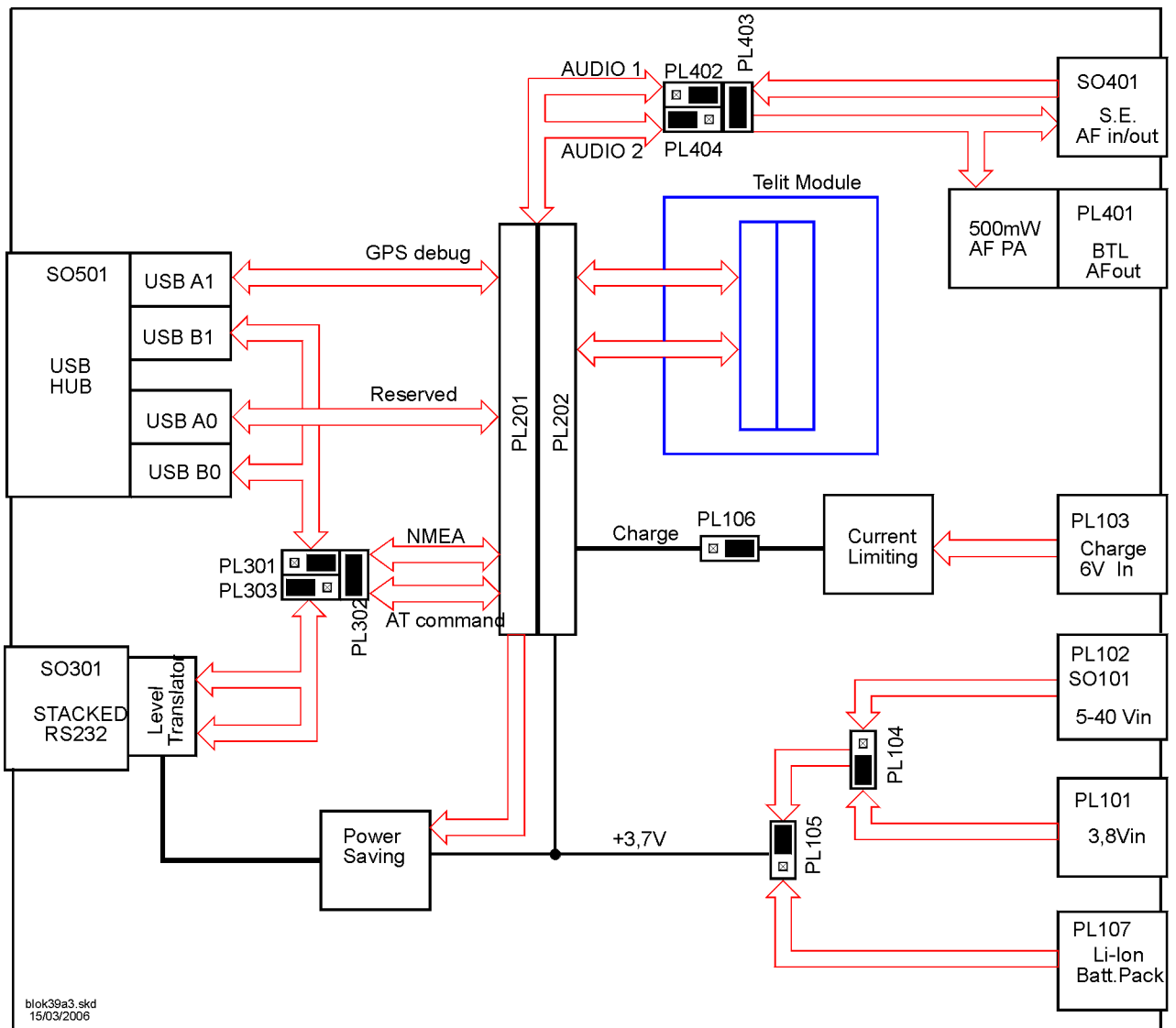

Miscellaneous signals, connections and routing on *CS1139B*.



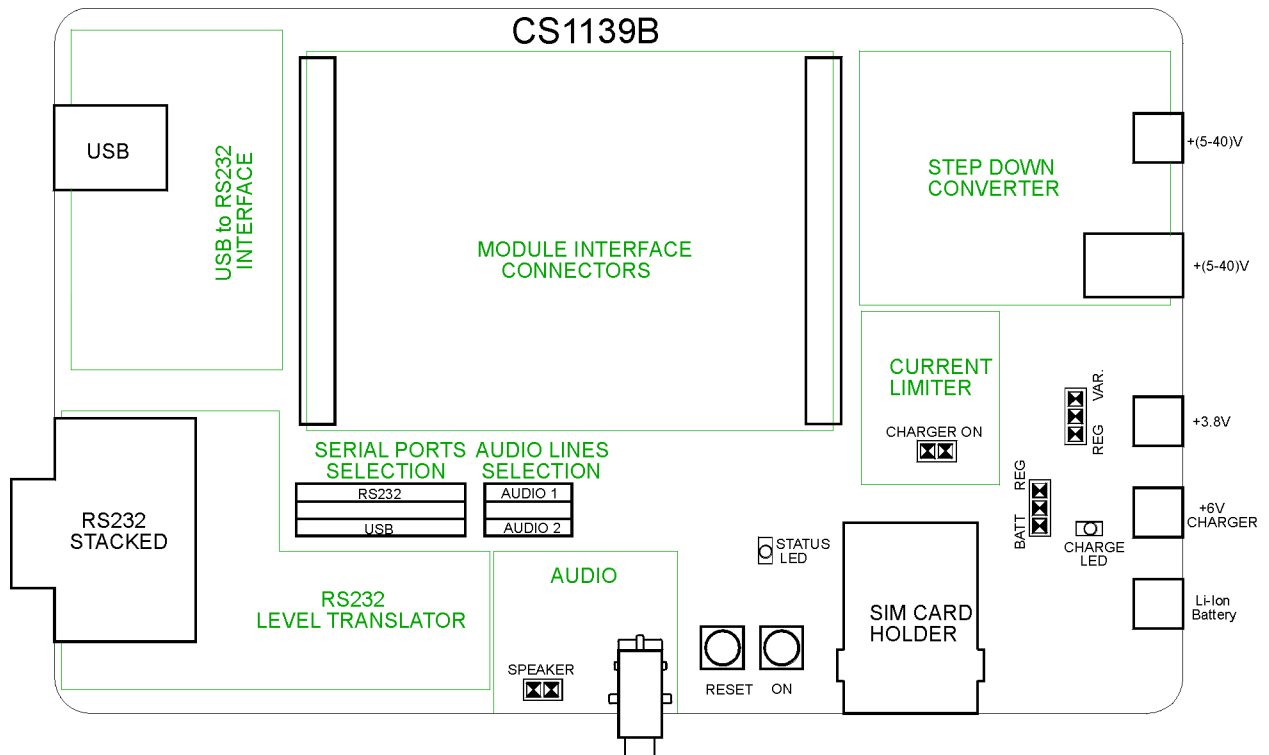

CS1139B circuitual displacement

## 2.1. PCB characteristics

Material: FR4  
 Thickness: 0,95 mm  
 Surface finishing: Chemical gold plate Ni 5um/ Au 0,1um





## 2.2. Mechanical characteristics of the assembled PCBs

### 2.2.1. Mother Board CS1139B

Length	100 mm (max 102,6 mm)
Width	160 mm (max 166,10mm)
Height	47,6 mm (included the support with columns)
Weight	200 gr (without any interface)

### 2.2.2. GM862 Interface CS1150B

Length	66,04 mm
Width	78,74 mm
Height	21,00 mm
Weight	27 gr (without the module)

### 2.2.3. GE863 Interface CS1151A

Length	75 mm (max 84,70mm)
Width	78,74 mm
Height	21,00 mm
Weight	40 gr (with module)
Weight	44,3 gr (with module for GPS version)

### 2.2.4. GE864 Interface CS1152B

Length	66,04 mm (max 75,20mm)
Width	78,74 mm
Height	21,00 mm
Weight	36 gr (with module)

### 2.2.5. GE864-GPS Interface CS1439B

Length	78.70 mm (max mm)
Width	83.70 mm
Height	21 mm



### 2.2.6. GC864 Interface CS1203B

Length	66,04 mm
Width	78,74 mm
Height	21,00 mm
Weight	27 gr (without the module)

### 2.2.7. GC864-C2 Interface CS1231X

Length	50,00 mm
Width	33,00 mm
Height	5,60 mm
Weight	13,8 gr (with module)

### 2.2.8. GE865 Interface CS1324A

Length	66,04 mm (max 75,20mm)
Width	78,74 mm
Height	21,00 mm
Weight	34 gr (with module)

### 2.2.9. GE865/SE867-AGPS Interface CS1433

Length	101.00 mm
Width	78.74 mm
Height	mm

### 2.2.10. GE865/JF2 Interface CS1521

Length	101,00 mm
Width	78,74 mm
Height	mm

### 2.2.11. GL865 Interface CS1431A

Length	66,04 mm (max 75,20mm)
Width	78,74 mm
Height	21,00 mm
Weight	34 gr (with module)



### 2.2.12. UC864-CC864 Interface KS0101C

Length	102,00 mm
Width	67,50 mm
Height	20,80 mm
Weight	55 gr (without module)

### 2.2.13. HE910 Interface CS1467C

Length	107,00 mm
Width	102,00 mm
Height	25,00 mm

### 2.2.14. UE910 Interface CS1467D

Length	107,00 mm
Width	102,00 mm
Height	25,00 mm

### 2.2.15. GE910 Interface CS1467D

Length	107,00 mm
Width	102,00 mm
Height	25,00 mm

### 2.2.16. GE910-GNSS Interface CS1467F

Length	107,00 mm
Width	102,00 mm
Height	25,00 mm

### 2.2.17. GE910-QUAD V3 Interface CS1467F

Length	107,00 mm
Width	102,00 mm
Height	25,00 mm

### 2.2.18. DE910 Interface CS1467D

Length	107,00 mm
Width	102,00 mm
Height	25,00 mm

### 2.2.19. CE910 Interface CS1467D

Length	107,00 mm
Width	102,00 mm
Height	25,00 mm



**2.2.20. GL865 V3 Interface CS1531B**

Length	92,00 mm
Width	89,00 mm
Height	25,00 mm

**2.2.21. LE920 Interface KS0145B**

Length	92,00 mm
Width	107,00 mm
Height	25,00 mm

**2.2.22. HE920 Interface KS0145B**

Length	92,00 mm
Width	107,00 mm
Height	25,00 mm

**2.2.23. HE910 V2 Interface CS1467D**

Length	107,00 mm
Width	102,00 mm
Height	25,00 mm

**2.2.24. UE910 V2 Interface CS1467D**

Length	92,00 mm
Width	107,00 mm
Height	25,00 mm

**2.2.25. CL865 Interface CS1531B**

Length	92,00 mm
Width	89,00 mm
Height	25,00 mm

**2.2.26. GE866-QUAD Interface CS1634**

Length	92,00 mm
Width	107,00 mm
Height	25,00 mm

**2.2.27. UE866 Interface CS1634**

Length	92,00 mm
Width	107,00 mm
Height	25,00 mm



## 2.2.28. UL865 Interface CS1531B

Length	92,00 mm
Width	89,00 mm
Height	25,00 mm

## 2.2.29. LE910 Interface CS1467F

Length	107,00 mm
Width	102,00 mm
Height	25,00 mm



### NOTE:

The overall height for every combination (mother board + interface board) is still the height of the mother board

---







## 4. Insertion of the Interface Boards

Every *Interface Board* must be inserted on *CS1139B* paying great attention to match the position of the main connectors; this has been made easy:

optically by a triangle drawn on both printed circuits (except CS1231X) ;  
mechanically shifting a column out of regular square cross position.

Both guide systems are highlighted by orange color as shown on the next figure.

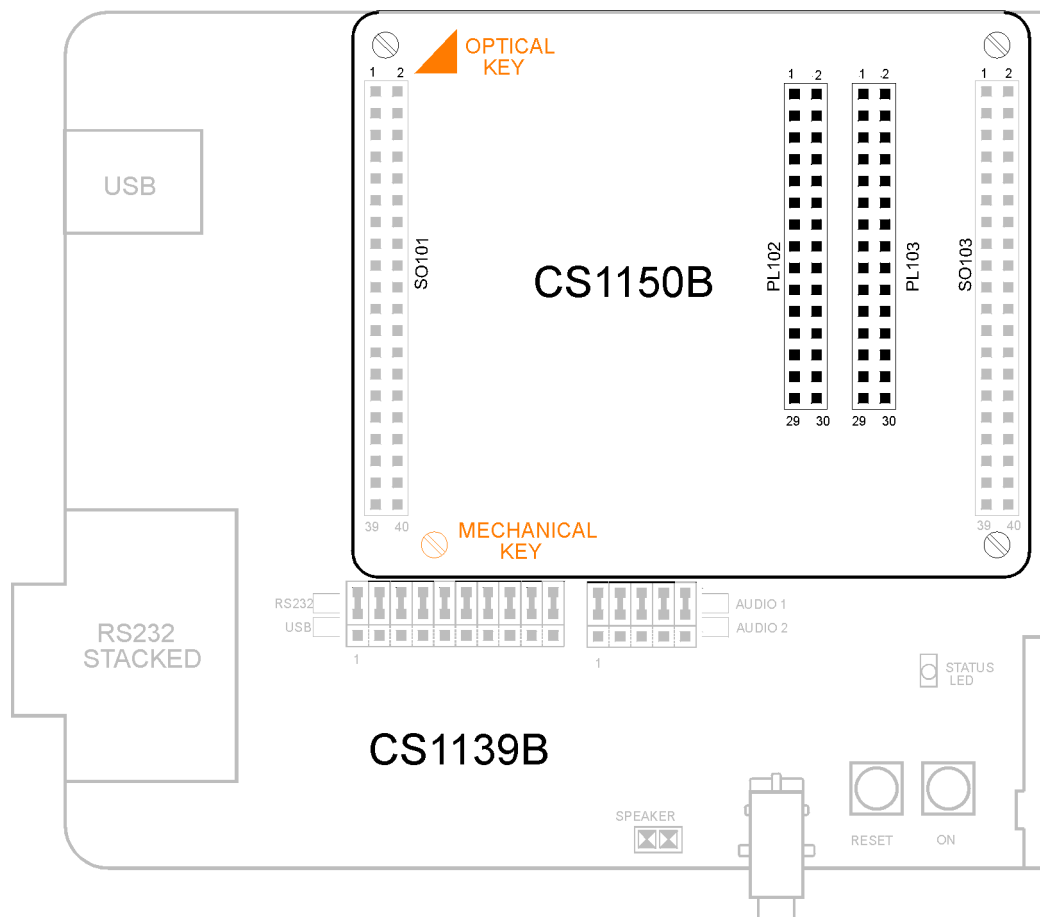

Positioning Guide Systems of *GM862 Interface Board* on CS1139B.



## 5. Power supply setting

The *EVK2* could be powered by different external sources, only one at time. The requested setting is made inserting the proper jumper connectors in the right position as described in the following paragraphs.

Be careful to the connections, even if every supply line is protected by a diode against “*polarity reversing*” and by a  $0\Omega$  resistor against “*short circuiting*”.

### 5.1. Fixed DC source

Connect a **+3,8V /  $\geq 2A$**  fixed DC source to PL101 respecting the polarization; short *pin2 & pin3 – PL104* and *pin1 & pin2- PL105* by 2 contacts jumper connectors. No other jumpers are needed.

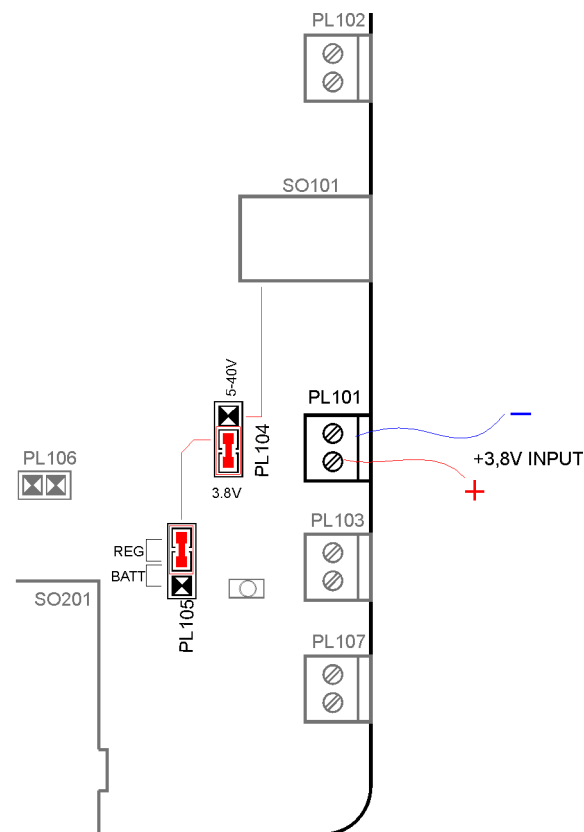

+3,8V fixed source setting



## 5.2. Variable DC source

Connect a  $+5\div 40\text{ V} / \geq 1\text{A}$  variable DC source to PL102 (by wires) or to SO101 (by coaxial plug), with care to the polarities. Short *pin1 & pin2-PL104* and *pin1 & pin2-PL105* by inserting 2 *contacts jumper* connectors. No other jumpers are needed.

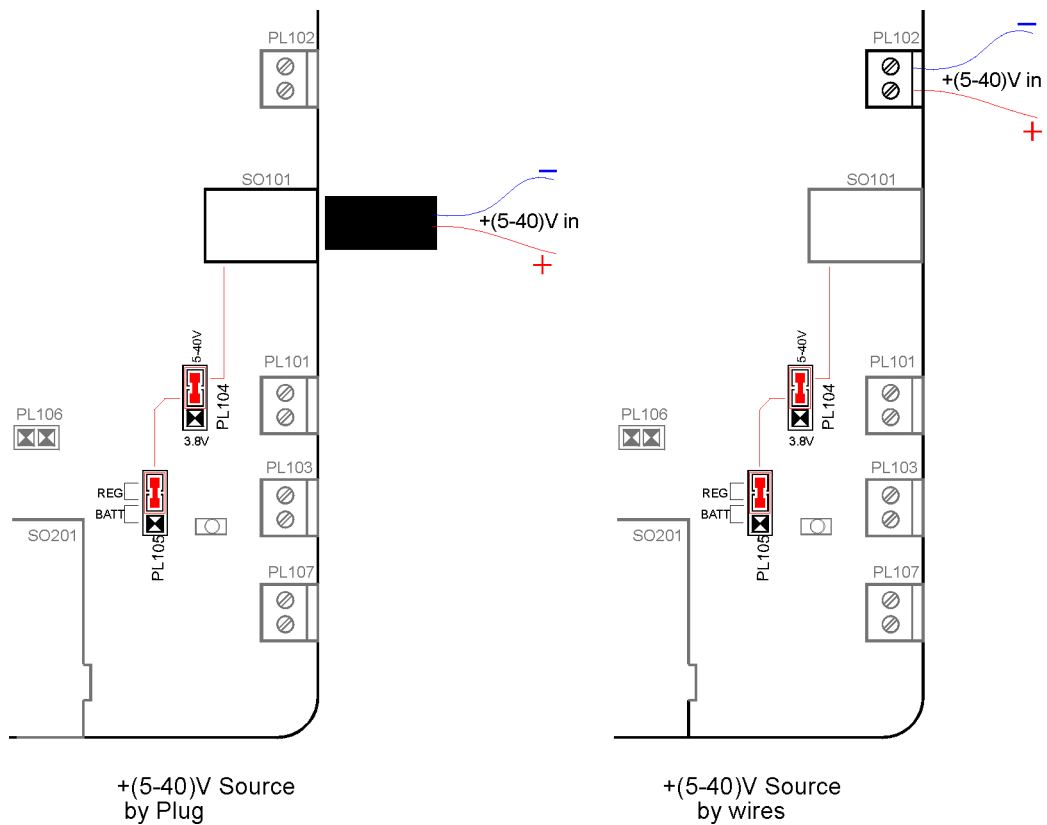

Variable DC source setting



### NOTE:

It is useful set the variable DC source at 6V minimum to avoid problems with voltage drops due to the length of the wires or the conductors gauge.



### 5.2.1. Coaxial Plug

The figure 7 shows the connections of the Power Plug of left part of figure 6.

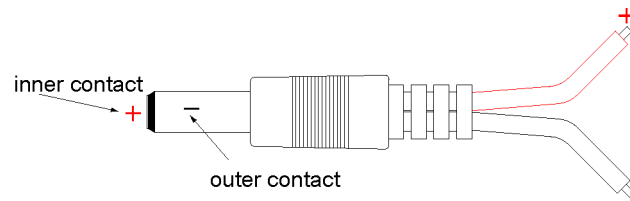

Coaxial “Power Plug” connection.

### 5.3. Li-Ion Battery pack and Charger

Connect a *Li-Ion battery pack* to PL107 with care to the polarity then short pin 2 & pin 3-PL105 by inserting the 2 contacts jumper connector.

If the battery pack needs to be recharged, connect a **+6V /  $\geq 0,5A$**  fixed DC source to PL103, with care to the polarity; short PL106 inserting a 2 contacts jumper connector as shown in figure 8: the yellow CHARGE LED will be on during the initial phase of charge. If you remove the battery pack when the charge stops (no current flows), immediately **REMOVE** also the jumper of PL106.

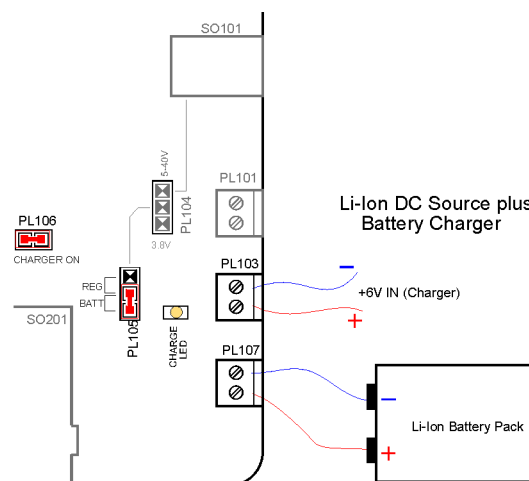

Battery Pack and Battery Charger wired connections and setting.



#### WARNING:

**NEVER CONNECT** any Battery Charging source to PL102 without connected Battery!!





## 5.4. Application Notes

### 5.4.1. Li-Ion Battery Pack

The 3.7V Li-Ion rechargeable Battery Pack should be connected directly to PL107 connector. Remember to use the connection cables as short as possible, with the appropriate conductors gauge and the other attributes, such as device power budget and cable flexibility, in order to match the specified voltage drop (especially during the high current absorption periods). To obtain the best performance we suggest a capacity of **1000 mAh** (not lower than 500 mAh).

### 5.4.2. About Current Charger

With a **+6V Current Unlimited Source** connected to PL103 connector, the battery pack will be directly charged through *VBATT connector pins* of the Telit Modules, under control of the *Internal Charge Algorithm* (only on models where is implemented).

Depending of the size, the Li-Ion cell manufacturers suggest a charge current value not greater than  $1,5C$  ( $C$ = Capacity of the battery pack, expressed in mAh); even if a lower current means a longer charging time, a current equal to  $0,5C$  is considered to be a good choice.

With reference to the schematic diagram *30276SE11139A –sheet1*, the Current Limiting Circuit (*Q102, Q103, R106, R107, R108, R109, R110, R111, R112, R113, C105*) sets the maximum value of the Charge Current in respect to the law:

$$I_{ch} = \frac{V_{be}Q102}{R_{par}} \rightarrow \text{where}$$

$$R_{par} = //R110, R111, R112, R113$$

With the default values, the charge current will be  $\sim 470\text{mA}$ , which will charge Battery Packs with a capacity from 350mAh to 1000mAh, **without any dissipation problem**.

If a higher capacity Battery Pack is needed, you must increment the Time Out in the Telit Modules.



---

#### WARNING:

**SET THE MAXIMUM VOLTAGE OF the CURRENT UNLIMITED SOURCE LOWER** than +8V.

---





## 6.1. Serial Port Setup

Communications between your application and the Telit modules are allowed connecting the DTE to the *Asynchronous Serial Interfaces* of Base-Band Chip, ASC0 and ASC1, through the *stacked standard RS232 communications port (double 9 way D-socket connector at slow data rates of RS232 protocol)* or a *standard USB-B Series receptacle (at higher data rates of USB1.1 specification through a CMOS HUB that realizes a multiple attachment point device)*.

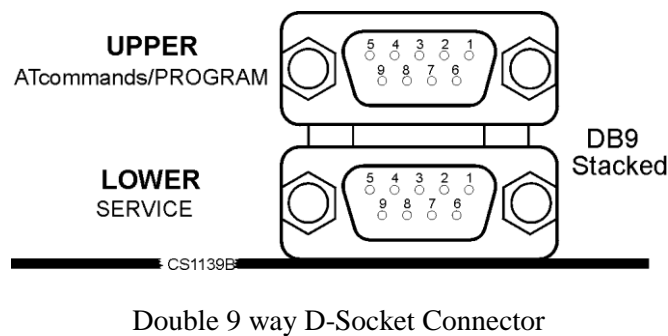

The selection is made short circuiting *PL302&PL303 (RS232 mode)* or *PL302&PL301 (USB 1.1 mode)* by 10 pieces of 2 contacts jumpers. This solution has been implemented because you can isolate every single line during the development.

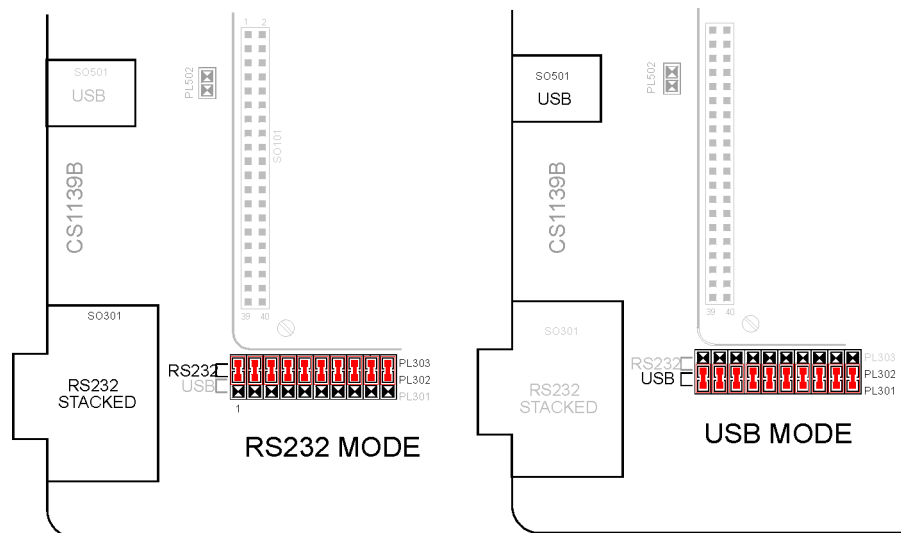

Serial Ports selection





## 7.2. Actual

The *HS* and *HF* definitions have been kept in the Software and on the schematics of the Telit modules, but with EVK2 we will refer to *Audio1* and *Audio2* section instead of *Handset* and *Handsfree* respectively, remembering that:

they can have fully equivalent electrical performances (*like the two microphone amplifiers*)  
they can activate the same functionalities (*like the Echo Canceller module*)  
they can offer slightly different performances (*like the two speaker buffering stages*)

### 7.2.1. The choice

The activation of the audio path is made Hardware by *AXE* line or Software by *AT#CAP* command.

If you don't have any load driving constraint (*like a speaker with an impedance coil lower than 16 ohm*), the choice between one or other "*block*" could be done without consideration related to the electrical performances; for example in order to overcome the PCB design difficulties.

## 7.3. Differential and Single Ended

### 7.3.1. Concepts

Any voltage can be characterized by a potential difference between two terminals.

The configuration of the two terminals and how the signal is delivered from output to input allows the signal to be more generally described in one of three ways:

*Single-ended signal*. This is a signal delivered between a signal trace and a ground. One terminal for a single-ended connection is always at fixed potential (*usually Ground*).

*Differential Signals*. These are signals that travel through a pair of traces. On the signal pair, neither of the terminals is Ground.

*Common mode Signals*. They represent a special case of differential signals, also travelling between a pair of traces, where the voltage potential on both signals is the same.





### 7.3.2. Benefits and disadvantages

Differential amplifiers are desirable to use, especially in audio applications where signal levels are very low such as those from microphones.

Classically, the benefits obtained from differential amplification are:

**Increase of Common Mode Rejection Ratio (CMRR)**

Differential inputs enable cancellation of any noise common on both inputs. Noise generated at the input of the amplifier has a greater effect than noise generated at the output, because any noise on the input is multiplied by the gain of the amplifier.

**Increase Signal to Noise Ratio (SNR)**

The inputs to the amplifier are especially sensitive to noise because they are typically not driven by a very low impedance source.

**High Rejection in Electromagnetic Interference (EMI)**

Noise immunity is very important in wireless phones because the RF signal is sent in bursts such that the frequency between bursts is in the audio band. RF rectification is such a problem that many manufacturers shield the audio portion of the phone.

**Double Useful signals level**

The signal levels from microphone and the voltage swing to the load are doubled. Then the AF power to the load it is 4 times the single-ended Afpower at the same voltage supply.

**No output blocking capacitor is needed**

Even if the differential outputs are biased at half-supply; no DC voltage exists across the load. You do not need the big, expensive and heavy blocking capacitors (generally from 33  $\mu\text{F}$  to 1000  $\mu\text{F}$ ), lowering the cost and saving PCB space

There is no frequency limiting effect due to the high pass filter network created with the speaker impedance and the coupling capacitance.

**Less shielding is required from amplifier to load**

Mainly we have only one disadvantage using differential amplification: the routing of one more signal line could be more difficult and the additional trace requires more board space.



### 7.3.3. Settings

Connecting your accessories to *SO401 in/out connector*, you will implement Single Ended Input/Output configurations.

Removing all 2 *contacts jumpers* inserted between *PL402&PL403* or *PL403&PL404*, the *in/out lines* of our modules will be directly available on *PL402* and *PL404* connectors.

In such a way, you will be able to implement fully Differential Input/Output configurations. Only with GC864-QUAD/PY-C2 modules the *Ear output* lines are AC coupled.

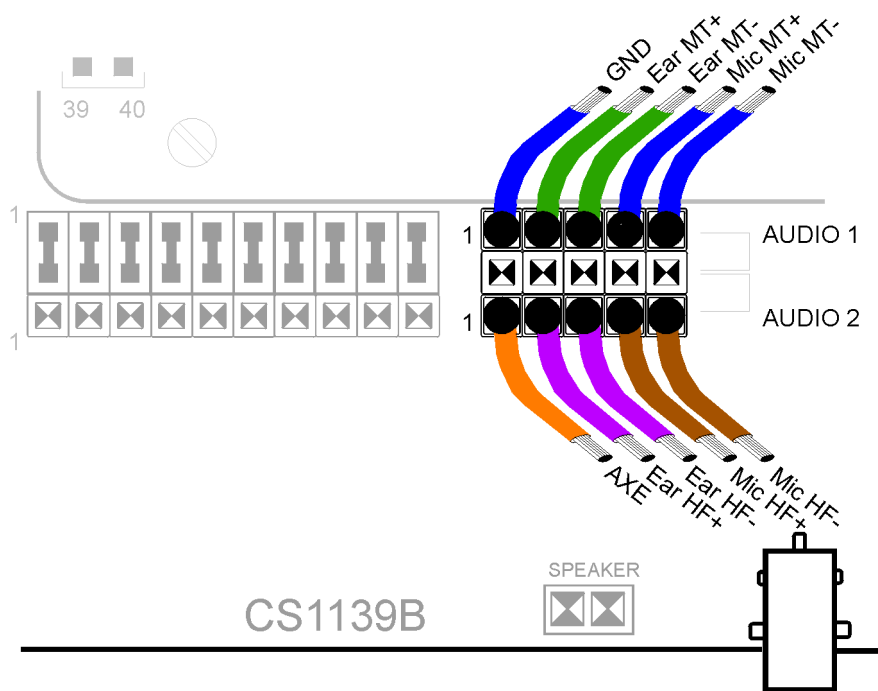

PL402 and PL404 Fully Differential audio lines.



## 8. AF Amplifiers Setting

The *Base Band Processor Audio Amplifiers* selection is made short-circuiting *PLA03&PLA02* (*RX Amplifier 1*) or *PLA03&PLA04* (*RX Amplifier 2*). In such a way you could verify the complete performance of both audio paths.

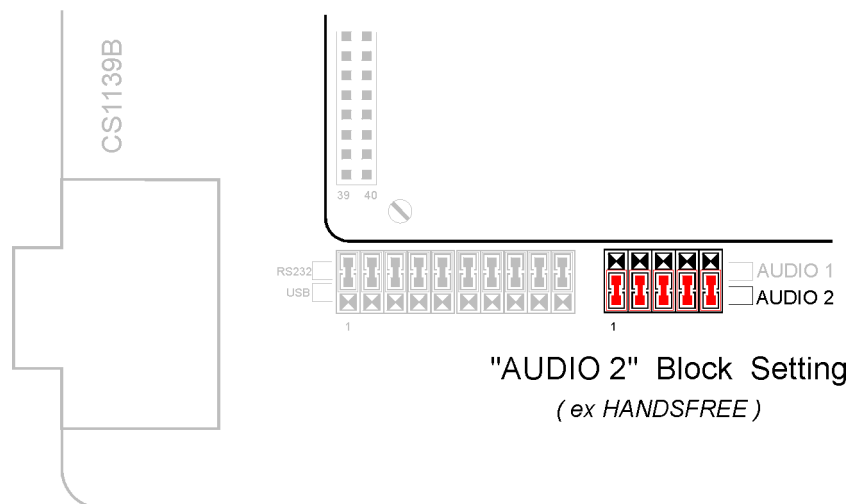
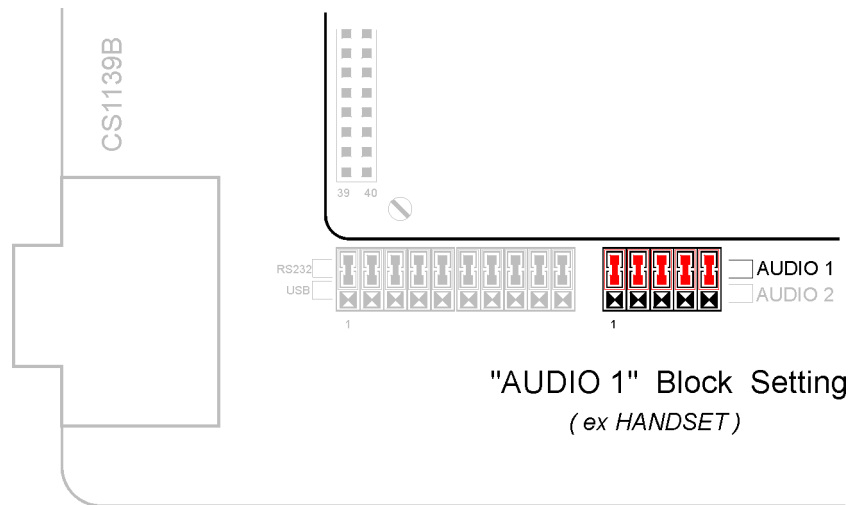

Base Band Audio Amplifiers selection









### 9.2.1. Speaker and Stand-alone Microphone

If you are using a Speaker, you can connect a *stand-alone electrete microphone* by a coaxial 2,5mm plug to SO401, respecting the following pin-out.

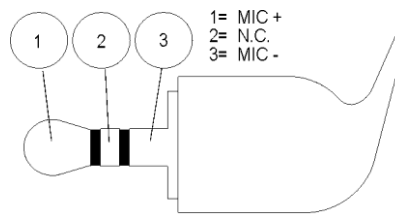
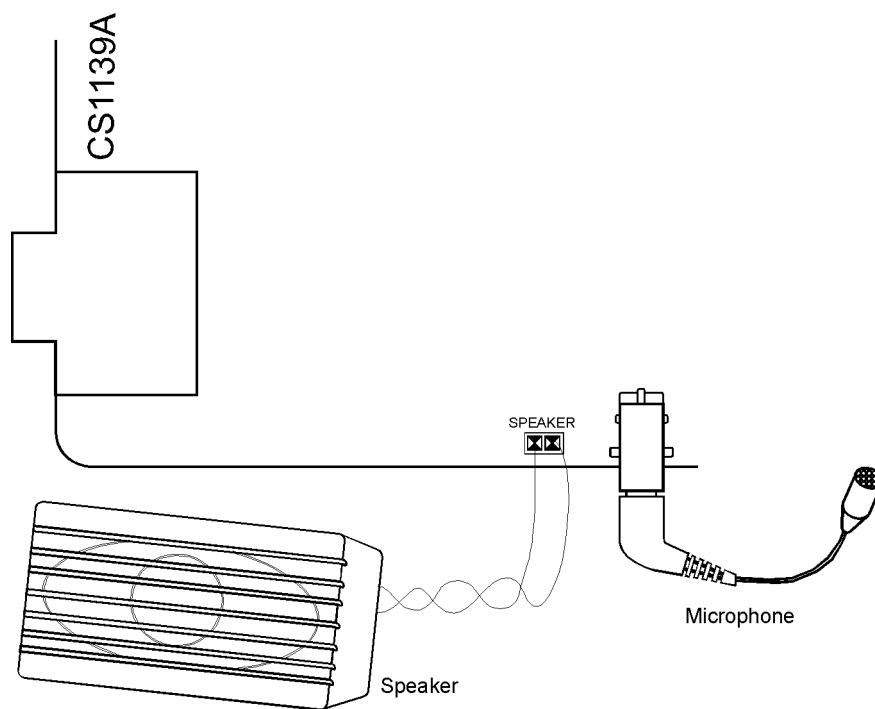

Figure 1: Microphone Plug Connection



Speaker & Microphone case insertion



## 9.2.2. Speaker plus Headset

If you have chosen to connect the Speaker to *HIGH AF POWER* output, without having a stand-alone electret microphone, it is also possible to connect a standard *off-the-shelf Headset* to SO401 without any problem, as shown in the figure 18: the AF output signal will be heard on both Speaker and Earpiece.



### **WARNING:**

You must use the right coil impedance depending from audio output you want to use.

If you sort out the *LOW AF POWER* solution connecting your Headset to SO401, the coil impedance **must be at least 16Ω@1KHz or higher**.

If you sort out the *HIGH AF POWER* solution connecting your Speaker to PL401, the coil impedance **must be at least 8Ω@1KHz or higher**

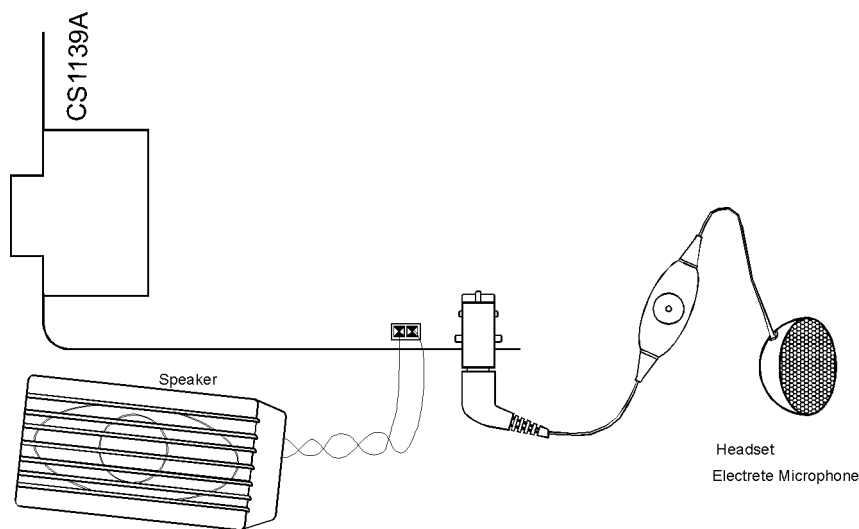

Speaker plus Headset insertion







## 11. Indication and services

### 11.1. Optical Indicators

#### 11.1.1. Status Led

It is a debug aid that shows information on the network service availability and Call status.

LED status	Device Status
Permanently off	Device off
Fast blinking (period 1s, Ton 0,5s)	Net search / Not registered / turning off
Slow blinking (period 3s, Ton 0,3s)	Registered: full service
Permanently on	A call is active

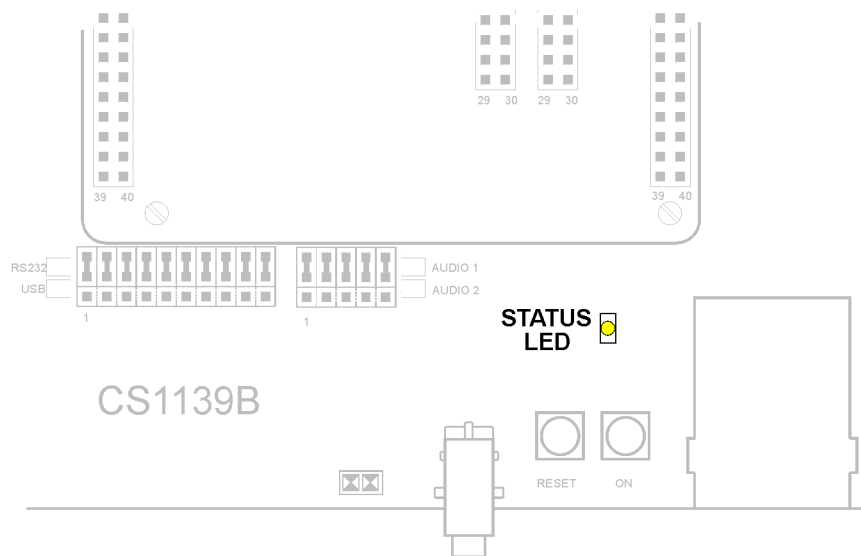

STAT\_LED position





### 11.1.2. CHARGE Led

A yellow LED is used as *Charge In Act* Indicator, as explained in the following table.

CHARGE LED	Meaning
Always on	Start Charge/ Hugh current Charge in act
Always off	Low current Charge in act/Charge stop

Table 7: CHARGE LED indications

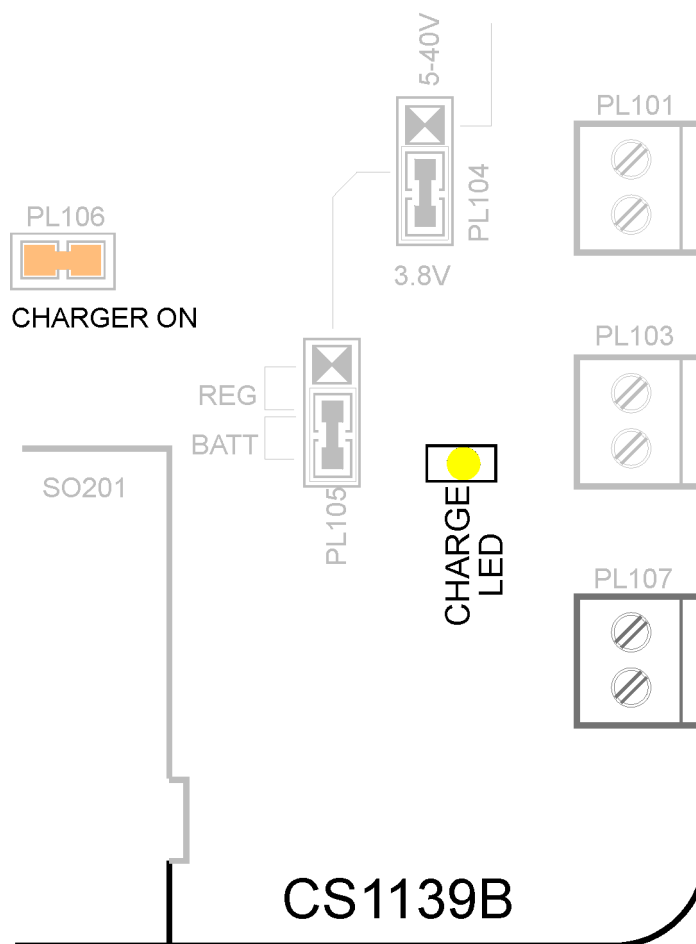

CHARGE LED position







31	EAR_HF-	AC Out Voltage	Audio
32	EAR_MT+	AC Out Voltage	Audio
33	AXE	DC voltage	INT/EXT Switching
34	MIC_HF-	AC In Voltage	Audio
35	MIC_MT+	AC In Voltage	Audio
36	MIC_HF+	AC In Voltage	Audio
37	MIC_MT-	AC In Voltage	Audio
38	GND	DC voltage	Power
39	GND	DC voltage	Power
40	GND	DC voltage	Power

<b>PL202-CS1139B</b>			
<b>Pin</b>	<b>Function</b>	<b>Type</b>	<b>NOTES</b>
1	VBATT	DC voltage	Power
2	VBATT	DC voltage	Power
3	VBATT	DC voltage	Power
4	VBATT	DC voltage	Power
5	GND	DC voltage	Power
6	GND	DC voltage	Power
7	GND	DC voltage	Power
8	GND	DC voltage	Power
9	CHARGE	DC voltage	Power
10	CHARGE	DC voltage	Power
11	GND	DC voltage	Power
12	GND	DC voltage	Power
13	GND	DC voltage	Power
14	GND	DC voltage	Power
15	ON_OFF*	DC voltage	Pull up to VBATT
16	NC		
17	RESET*	DC voltage	Module Reset
18	NC		
19	NC		
20	NC		
21	STAT_LED	Open Collector	Status Indicator LED
22	NC		
23	NC		
24	NC		
25	GND	DC voltage	Power
26	GND	DC voltage	Power
27	GND	DC voltage	Power
28	GND	DC voltage	Power
29	NC		
30	NC		
31	SIMIO	3V Only	SIM Data I/O
32	SIMCLK	Digital Signal	SIM Clock



33	SIMRST	DC voltage	SIM Reset
34	SIMVCC	DC voltage	SIM Power
35	SIMIN	DC voltage	SIM inside detector
36	NC		
37	NC		
38	GND	DC voltage	Power
39	GND	DC voltage	Power
40	GND	DC voltage	Power



## 13. Module Interface Boards

### 13.1. Generality

You can use your **EVK2** with see **APPLICABILITY LIST** Telit modules fitted on its own *Interface Board*; all connections are made through *2x40 contacts* connectors.

It's possible to use these *Interface Boards* also in stand-alone mode, inserting the “*not mounted*” components (*related to RESET BUTTON, ON BUTTON, SIM HOLDER and STATUS LED functions*) plus the use of an external *level translator* circuit.

For more information refer to Telit Product Description.

### 13.2. Short Description

The interface boards convert the module connection technology (*board-to-board or BGA soldering*) into a PTH pin connector. The part of the basic interfaces is served by the motherboard, whereas specific interfaces according to the type of the module (*antenna, general purpose inputs/outputs GPIO, ADC/DAC, UART*) are available on the adapter board to connect it to the user applications, extension boards, measurements equipment or other tools.

### 13.3. Further Accessories for GPS version

When test the GPS products, besides the content of the single kits you need the accessories listed in below table.

SMA/MMCX cable adapter	Module under test	Interface Board	GPS Antenna
1ff1400073tlb		P/N	1rr0100071tlb
1	GM862-GPS	3990250670	1
-	GE863-GPS	3990250671	1
-	GE864-GPS	TBD	1
-	SE867-AGPS	TBD	1
-	HE910	3990250845	1





## 14. GM862 Interface

This board allows easily interfacing the module with the EVK2 and testing its functionalities; any version of GM862 can be insert.  
No settings are needed.



GM862 Interface Board

### 14.1. Stand-alone setup

If you need to use the interface out of EVK2 (*Stand-alone* setup) you have to mount the following missing components:

RESET Button  
ON Button;  
STATUS LED and its load resistance.







## 15.2. Content of the kits

Please check out the contents of your interface kit; if any of the items is missing, please contact your supplier.

### 15.2.1. GE863-PY/QUAD version

Description	Quantity
GE863 INTERFACE BOARD	1
2 PIN JUMPER FEMALE CONN	2

### 15.2.2. GE863-GPS version

Description	Quantity
GE863-GPS INTERFACE BOARD	1
2 PIN JUMPER FEMALE CONN	2

### 15.2.3. GE863-SIM version

Description	Quantity
GE863-SIM INTERFACE BOARD	1
2 PIN JUMPER FEMALE CONN	2

## 15.3. Interface connectors

The following connectors are available in any version:

GSM RF connector (*SMA Female*)

2 male connectors (4 pins each one: PL101, PL102) to select the Serial port configuration  
 2 female connectors (40 pins each one: SO101, SO106) to connect the interface to the EVK2 mother board circuits (power supply lines, serial in/out lines, audio in/out lines)  
 2 male connectors (30 pins each one: PL103, PL104), on which it is possible to connect external devices like user's application, Telit extension boards, measurements equipment or other tools

## 15.4. Additional components for GPS version

The following components are available only in GPS version (P/N 3990250671):

GPS RF connector (*SMA Female*)

USB B-type connector and its circuitry (*see schematic 30276SE11151A*)







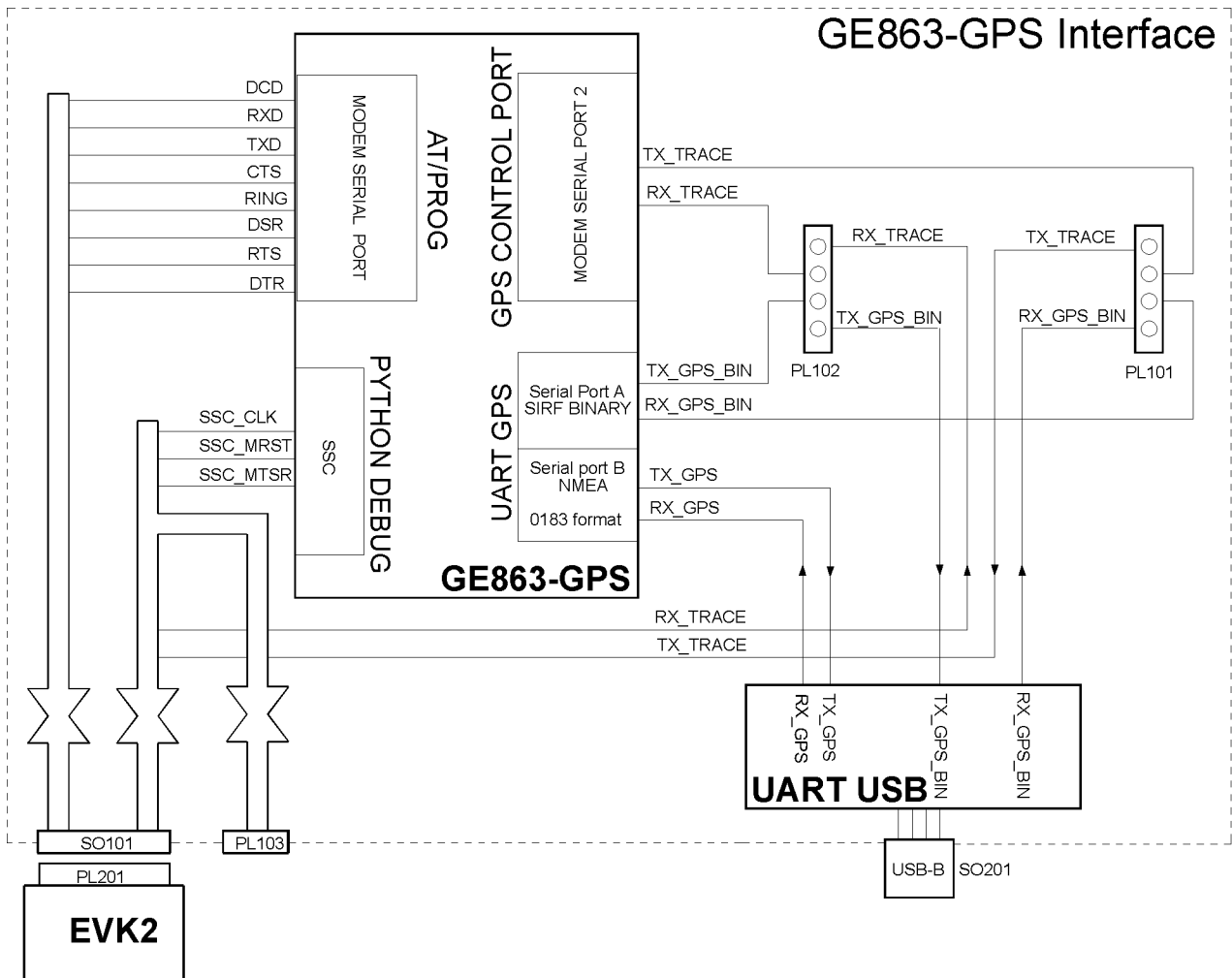

GE863-GPS Serial ports block diagram

## 15.6. Serial port configuration

To switch the serial lines you must short-circuit the PL101-PL102 connectors by 2 contacts jumpers.





### 15.6.1. GE863-PY/QUAD

The 2 contacts jumpers have to be fitted between **pin1&pin2** of PL101-PL102 connectors. This carries out the *Python Debug Port* on Trace Port of EVK2.

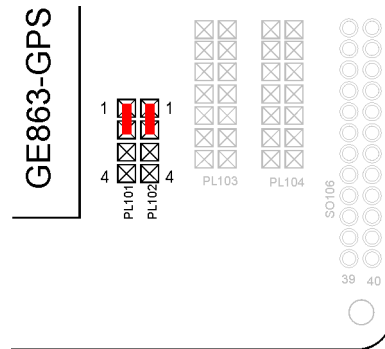

Jumpers setting for GE863-PY/QUAD

### 15.6.2. GE863 – GPS

The 2 contacts jumpers have to be fitted between **pin2&pin3** or **pin3&pin4** of PL101-PL102 connectors.

**“CONTROLLED MODE”**

This set the *SIRF Binary* to serial port of the modem. (*Typical application Design*)

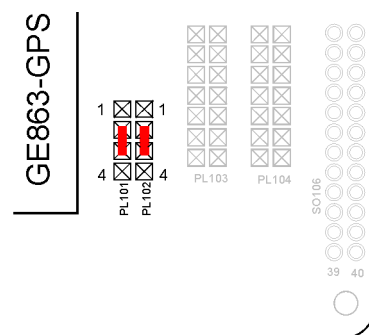

Jumpers setting for SIRF BINARY port connected to MODEM port 2



**NOTE:** All AT GPS commands are available in this configuration



**“SEPARATED SERIAL PORT”**

This set the *SIRF Binary* available on the USB connector.

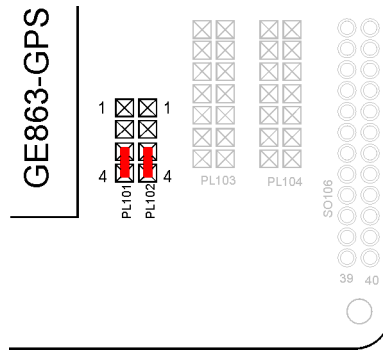

Jumpers setting for SIRF BINARY port available on USB connector



**NOTE:**

In this configuration some AT GPS commands are not available. Refer to AT Commands Reference User Guide.

















## 17.5. Power supply

The module (but not the whole interface) receives its power supply from PL105: this jumper must always be plugged in, except when a series measurement instrument is needed.

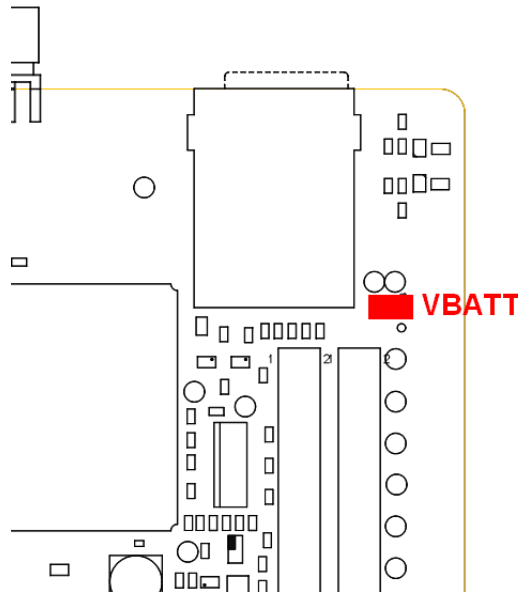

Jumper for VBATT.

## 17.6. GPS external LNA enable signal

The module contains an internal LNA for the GPS antenna that is enabled by default. The user can though decide to use an external LNA: this option is selected by means of a software command, which puts the internal LNA in a low gain mode and provides an additional signal to enable the external LNA. The interface can provide a bias for the external LNA, and the user can choose whether to enable it by this signal or to leave it always enabled, by means of a jumper on PL104, as shown in the picture below.



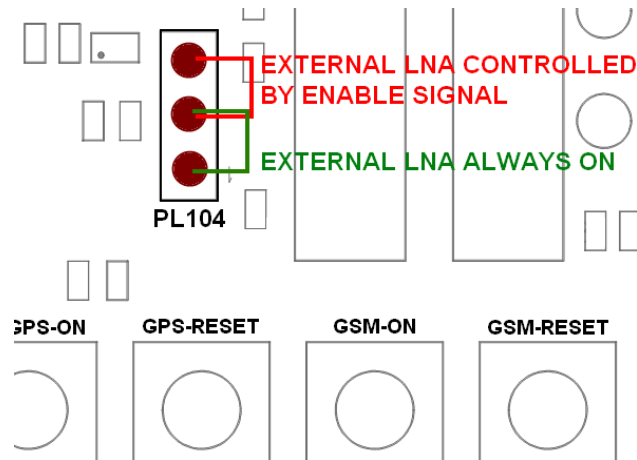

Jumper on PL104.

## 17.7. Serial port configuration

By means of proper jumper connections on PL201, three different configurations for serial outputs can be selected. These configurations are mutually exclusive.

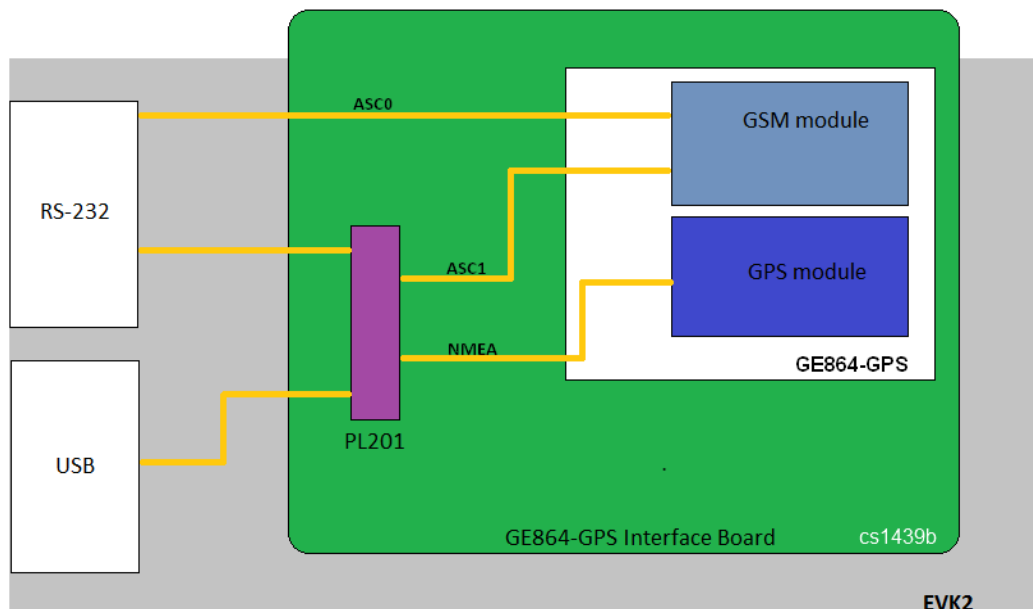

GE864-GPS Interface Board serial connections



### 17.7.1. ASC1 to RS-232

This configuration connects the ASC1 UART to the Trace serial connector of the EVK2.

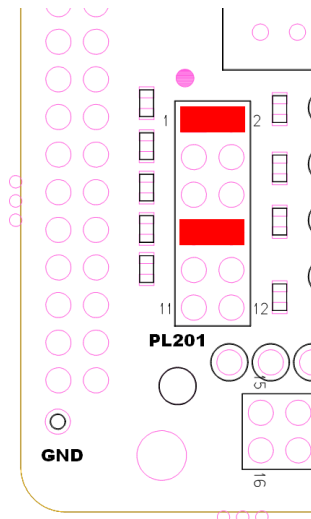

ASC1 to RS-232 (Trace) configuration

### 17.7.2. GPS to ASC1 (internal host controlling configuration)

This configuration directly connects the host GSM module to the GPS receiver, thus setting the GPS receiver in Controlled Mode.

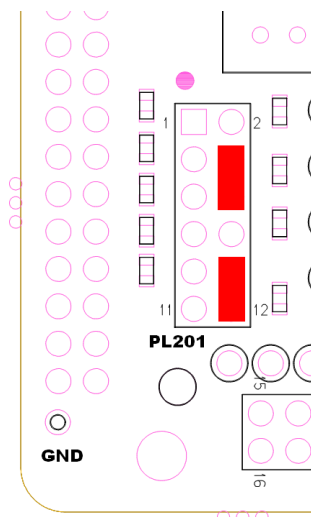

GPS to ASC1 configuration





**WARNING:**

Other than the ASCII UART, the user must also connect the host module's GPIOs to the corresponding signals of the GPS receiver (as explained in the next paragraphs).

### 17.7.3. GPS to RS-232 (external host controlling configuration)

This configuration allows sending the GPS output to the Trace serial connector of the EVK2.

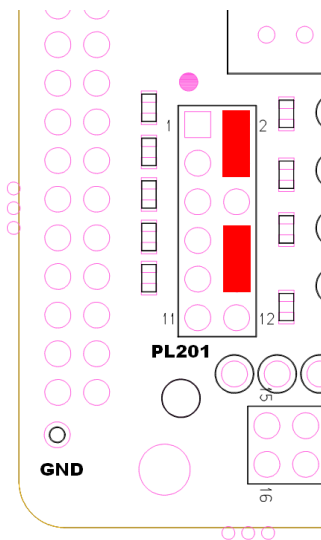

GPS to RS-232 (Trace) configuration

### 17.7.4. GPS to USB

The NMEA sentences can be redirected to EVK2's USB port by setting PL201 as explained in the Figure 37, i.e. connecting the NMEA line with the RS-232, and at the same time setting the EVK2 serial line on USB Mode, as shown in Paragraph 7.1 of this document.



## 17.8. GPIO settings

The interface allows choosing among different options for driving the GPS control signals:  
Using the GPIOs of the GSM module

Using an external host

Manually controlling the signals by plugging a jumper.

The last option is not available for every signal and every configuration; please refer to the schematics of the interface for more details.

The choice among the options can be made by PL102, as detailed below.

### 17.8.1. Internal host controlling configuration

The following settings on PL101 and PL102 allow selecting the internal host configuration.  
Two different cases have to be considered:

cs1439b-A

cs1439b and cs1439b-B

Refer to the beginning of this chapter for the correspondence between board part number and mounting options.

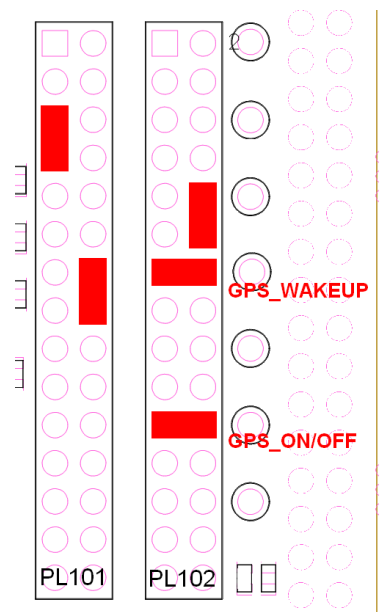

Settings for PL101 and PL102: internal host,cs1439b-A





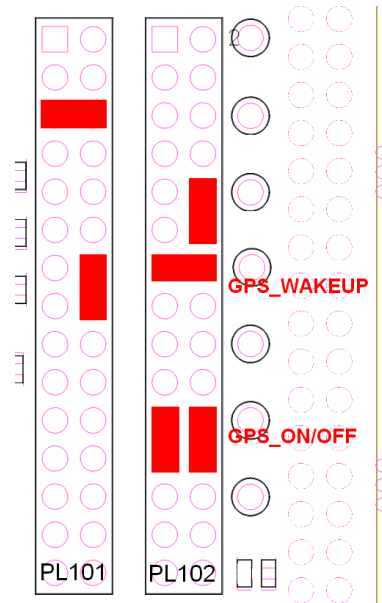

Settings for PL101 and PL102: internal host, **cs1439b** and **cs1439b-B**

Note that jumper settings are detailed in the pictures above.

The signal connected to **pin10** of PL102 is no longer available, and it is recommended to tie it to ground by plugging a jumper between **pin10 & pin12** of PL102.

## 17.8.2. External host controlling configuration

When an external host is used to drive the GPS module, two different cases have to be considered:

**cs1439b-A**

**cs1439b** and **cs1439b-B**

Refer to the beginning of this chapter for the correspondence between board part number and mounting options.

Two jumpers must be plugged, between **pin14 & pin16** of PL101 and **pin10 & pin12** of PL102. Additionally, the host GPIOs must be connected to PL102 as shown in the pictures below.

Note that in this configuration the signal on **pin10** of PL102 is no longer available and it must be connected to ground by plugging a jumper on **pin10 & pin12** of PL102.



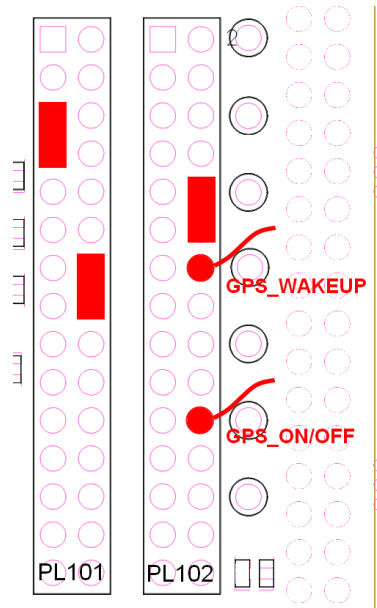

Settings for PL101 and PL102: external host, **cs1439b-A**.

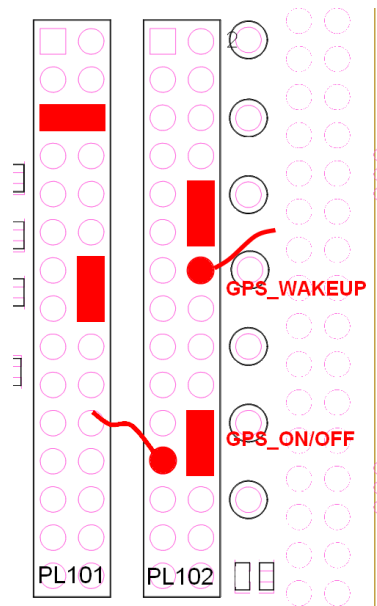

Settings for PL101 and PL102: external host, **cs1439b and cs1439b-B**.



## 17.9. Antenna connectors

### 17.9.1. GSM antenna connector

A GSM antenna must be connected to SO105.

### 17.9.2. GPS antenna connector

A GPS antenna must be connected to SO103.



---

**WARNING:**

Don't connect a *GSM* antenna on this connector

---



## 18. GE865 – SE867 AGPS Interface

This board allows testing the functionalities and performance of the GE865 and SE867 modules interconnected according to Telit guidelines.

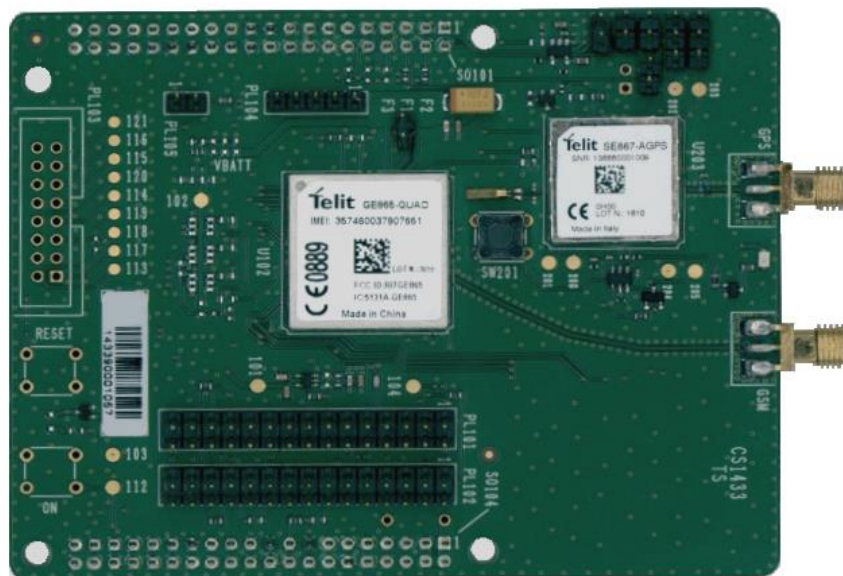

GE865/SE867-AGPS Interface Board

### 18.1. Stand-alone setup

The interface can be used without the EVK2, in this case the following components have to be soldered on the board:

- the RESET button
- the ON button
- the STATUS led and its load resistor.





## 18.4. Serial connections

By means of proper jumper connections on PL201, PL202, PL206, and PL207, three different configurations for serial outputs can be selected.

### 18.4.1. GSM to GPS (GSM controlling configuration)

This configuration is achieved by plugging a female jumper connector on **pin1 & pin2** of both PL201 and PL206. It allows to connect the GE865 UART with SE867-AGPS UART, thereby putting the board in the so-called controlled mode. No connection with the EVK2 RS-232 Trace is present.

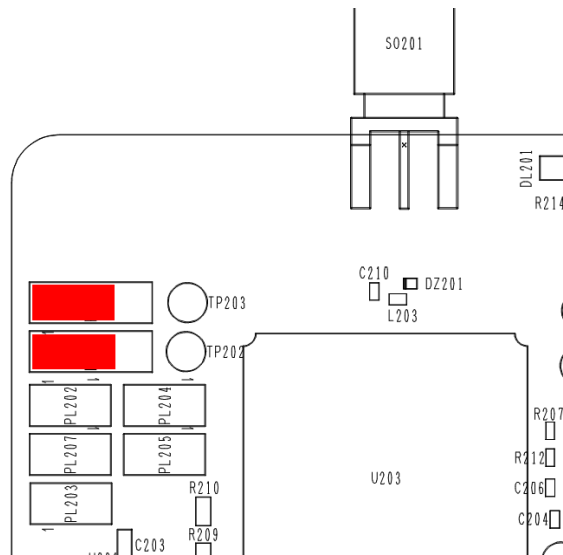

Jumpers in controlled mode configuration.







### 18.4.3. GPS to Trace(external host controlling configuration)

This configuration is achieved by plugging two female jumper connectors on PL202 and PL207. It allows redirecting the SE867 UART to the EVK2 RS-232 Trace. No connection with the GE865 UART is present.

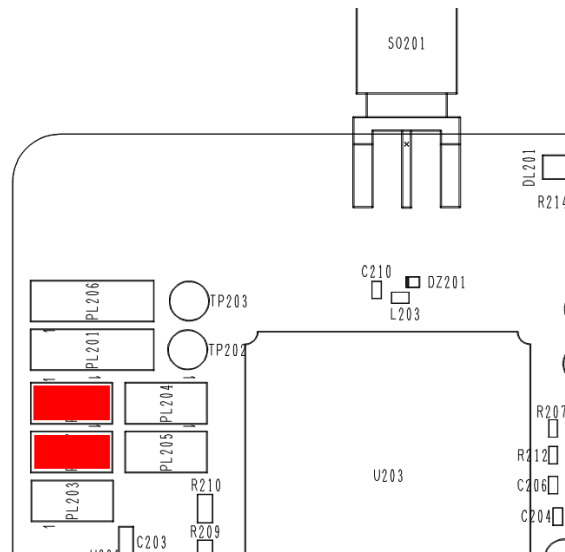

Jumpers in GPS to Trace configuration.

## 18.5. Antenna connectors

### 18.5.1. GSM antenna connector

A GSM antenna must be connected to SO103.

### 18.5.2. GPS antenna connector

A GPS antenna must be connected to SO201.



**WARNING:**

Don't connect a *GSM* antenna on this connector



## 19. GE865 – JF2 Interface

This board allows testing the functionalities and performance of the GE865 and JF2 modules interconnected according to Telit guidelines.

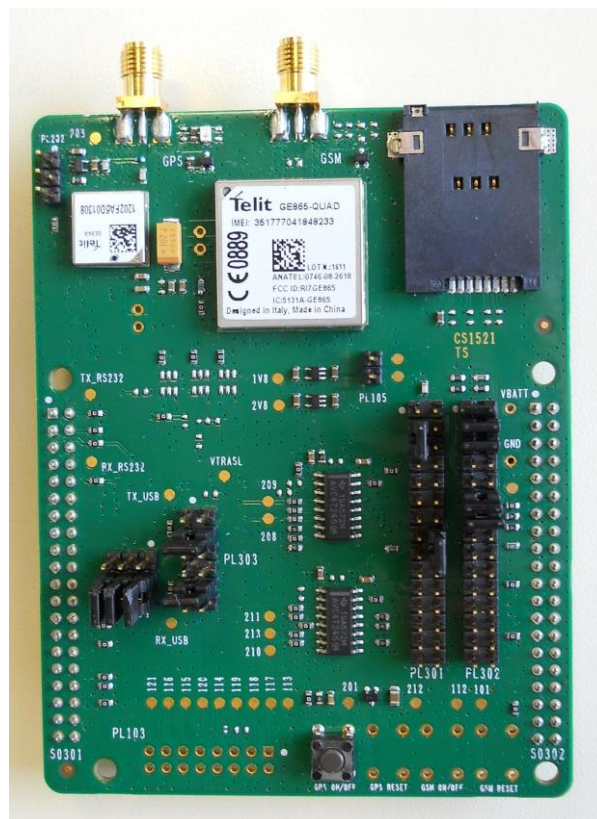

GE865/JF2 Interface Board.

### 19.1. Stand-alone setup

The interface can be used without EVK2 and in this case the following components have to be soldered to the board:

- RESET button
- GSM ON/OFF button
- GSM STATUS led and its load resistor



## 19.2. Interface connectors

The following connectors are available:

- 2 male connectors (30 PTH pins each: PL301 and PL302), to connect external devices, user's applications, Telit extension boards, measurement equipment or other tools; PL301 can also be used to select particular configurations between the GSM module's GPIOs and the GPS module
- 2 female connectors (40 PTH pins each one: SO301 and SO302), to connect the interface to the EVK2 mother board circuits (power supply lines, serial in/out lines, audio in/out lines)
- 1 GSM RF connector (SMA Female: SO105)
- 1 GPS RF connector (SMA Female: SO201)
- 1 JTAG connector (PL103, not mounted)
- 1 male connector (3 PTH pins: PL202), to select an enable signal for the external GPS LNA,
- 1 male connector (12 PTH pins: PL303), to select one of the available configurations for the Serial and USB ports.
- 1 male connector (2 PTH pins: PL105), that can be used to insert an ammeter in series with the supply, in order to monitor the module's current consumption,
- 1 male connector (9 PTH pins: PL304), in order to set the data format between USB or SSC0 lines to send to EVK2.

## 19.3. Contents of the kit

Please check out the contents of your interface kit. If any of the following items is missing, contact your Telit supplier.

Description	Quantity
GE865/JF2 INTERFACE	1
JUMPERS	15

## 19.4. Power supply

The GE865 module (but not the whole interface) receives its power supply from PL105: this jumper must always be plugged on except when a series measurement instrument is needed.



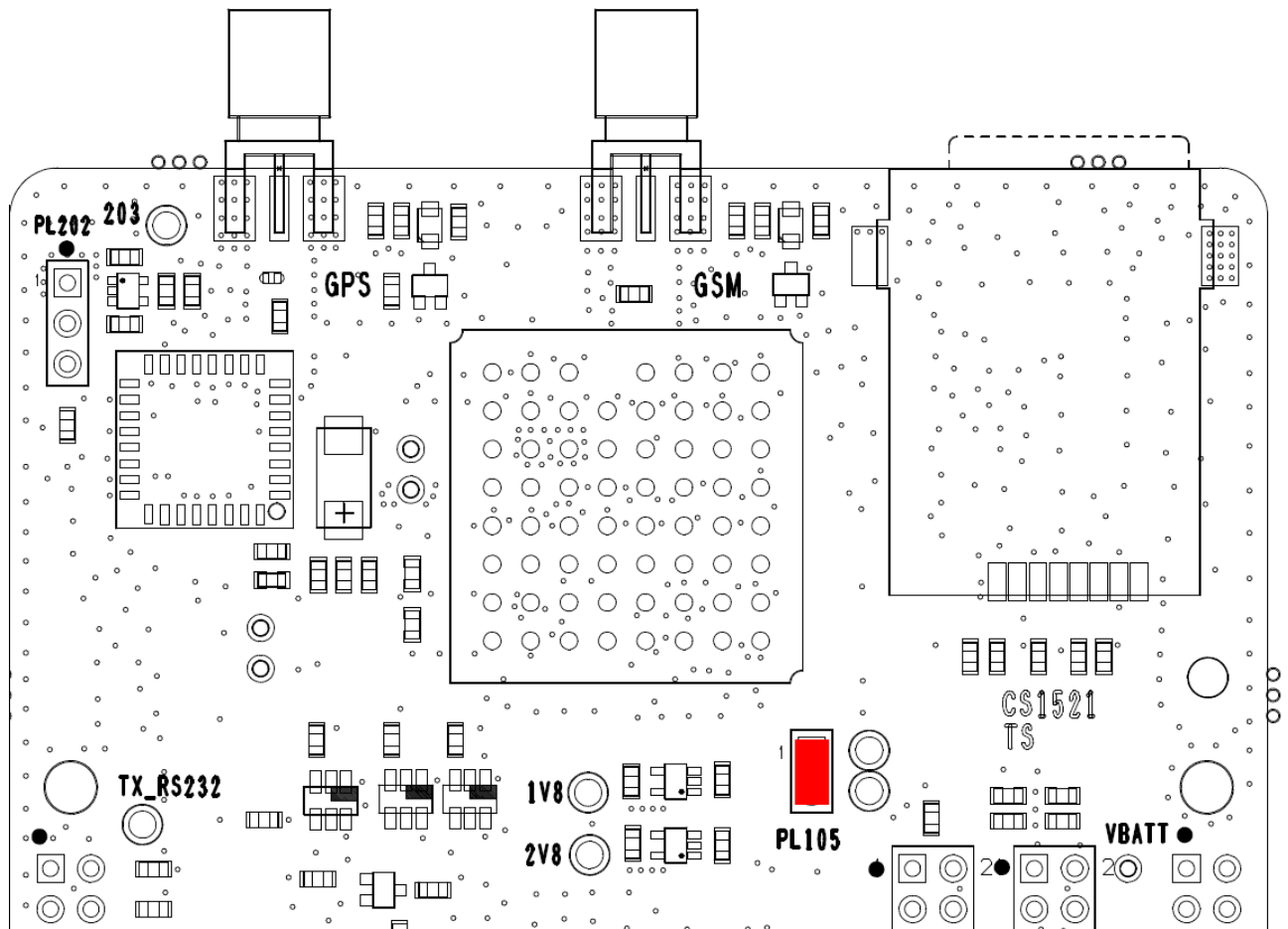

Jumper for VBATT.

## 19.5. GPS external LNA enable signal

The module contains an internal LNA for the GPS antenna.

The user can though decide to use an external LNA: this option is selected by means of a software command, which puts the internal LNA in a low gain mode and provides an additional signal to enable the external LNA. The interface can provide a bias for the external LNA, and the user can choose whether to enable it by this signal or to leave it always enabled, by means of a jumper on PL202, as shown in the picture below.







## 19.6. Serial port configuration

By means of proper jumper connections on PL303, it is possible to choose different configurations for serial or USB outputs. These configurations are mutually exclusive.

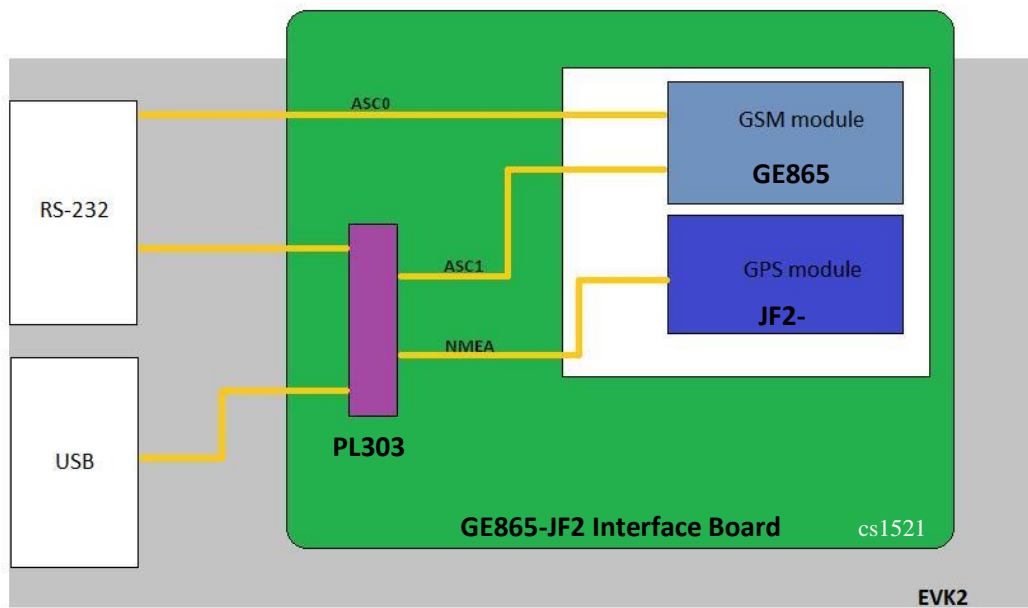

GE865-JF2 Interface Board serial connections



## 19.7. GSM to Trace

This configuration connects the GSM to the RS232 serial connector of the EVK2.

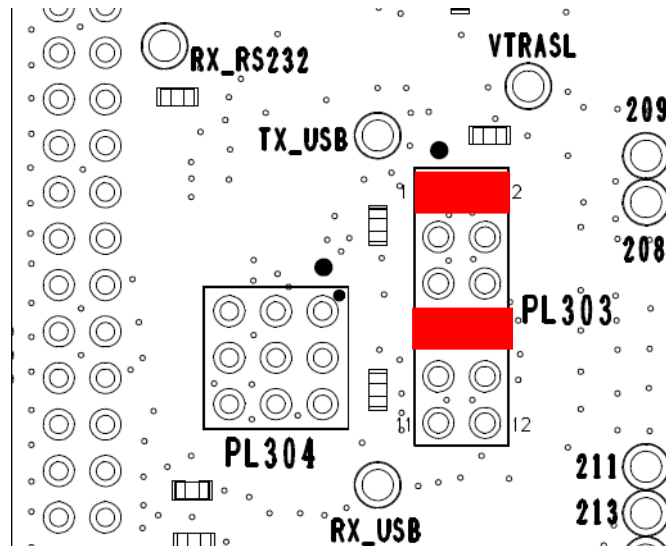

GSM to RS-232 (Trace) configuration

## 19.8. GPS to Trace

This configuration allows sending the GPS output to the Trace serial connector of EVK2 by means of transceivers.

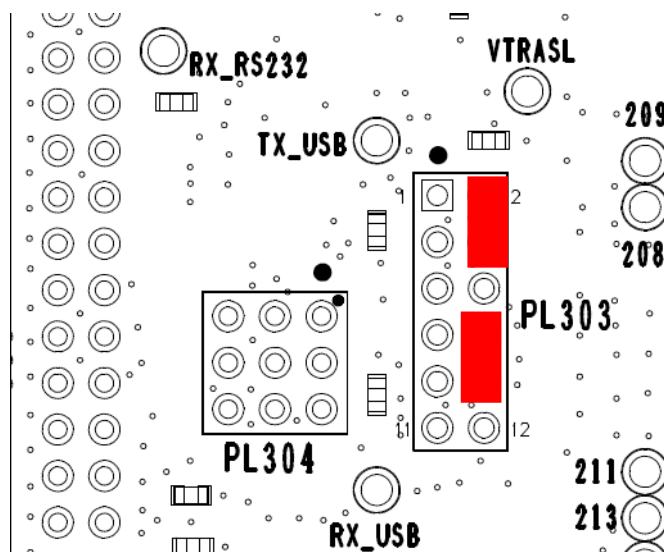

GPS to RS232 (Trace)



## 19.9. GSM to USB

This configuration connects the GSM to the USB connector of the EVK2.

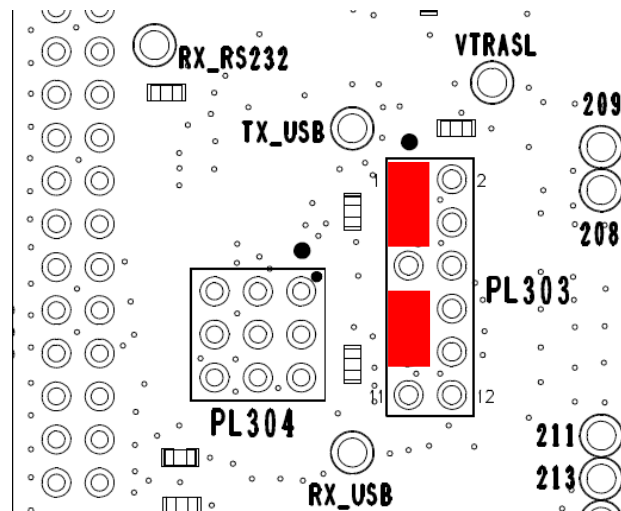

GSM to USB

## 19.10. GPS to USB

The NMEA sentences can be redirected to the EVK2's USB port by setting the PL303 as explained in the Figure 53, i.e. connecting the NMEA line with the RS-232, and at the same time setting the EVK2 serial line on USB mode, as showed in Paragraph 7.1 of this document.

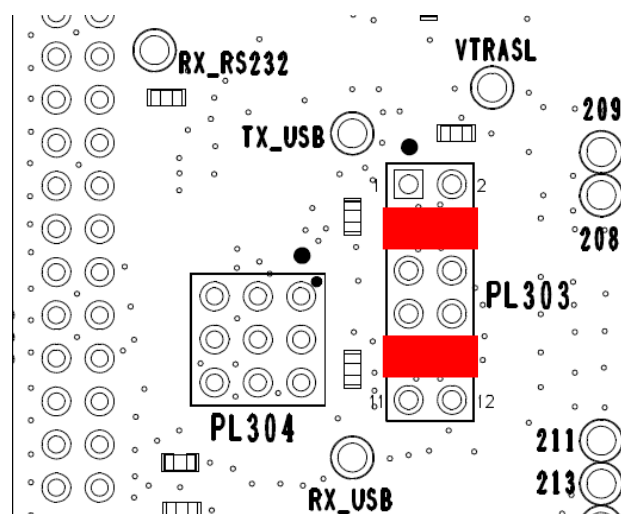

GPS to USB



## 19.11. GPS to GSM (internal host controlling configuration)

This configuration directly connects the host GSM module to the GPS receiver, thus setting the GPS receiver in Controlled Mode.

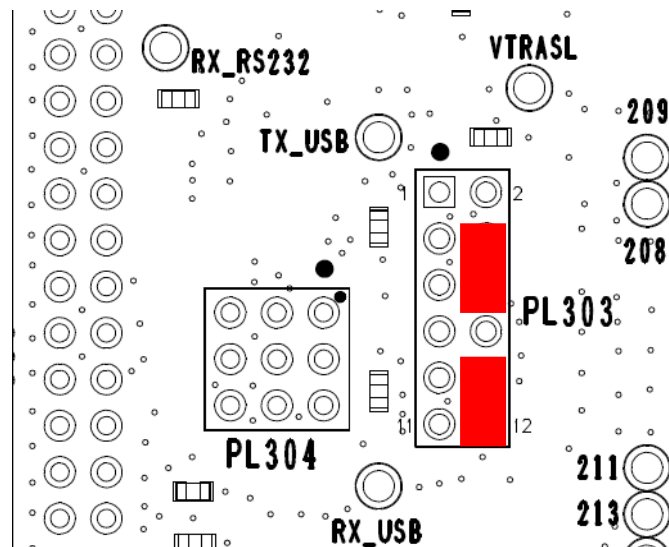

GPS to GSM configuration

## 19.12. GPIO settings

The interface allows choosing among different options for driving the GPS control signals:

- Using the GPIOs of the GSM module
- Using an external host
- Manually controlling the signals by plugging jumpers.

The last option is not available for every signal and every configuration; please refer to the schematics of the interface for more details.

The choice among the options can be made by PL301 and PL302, as detailed below.





### 19.12.1. Internal host controlling configuration

The following settings on PL301 and PL302 allow selecting the internal host configuration.

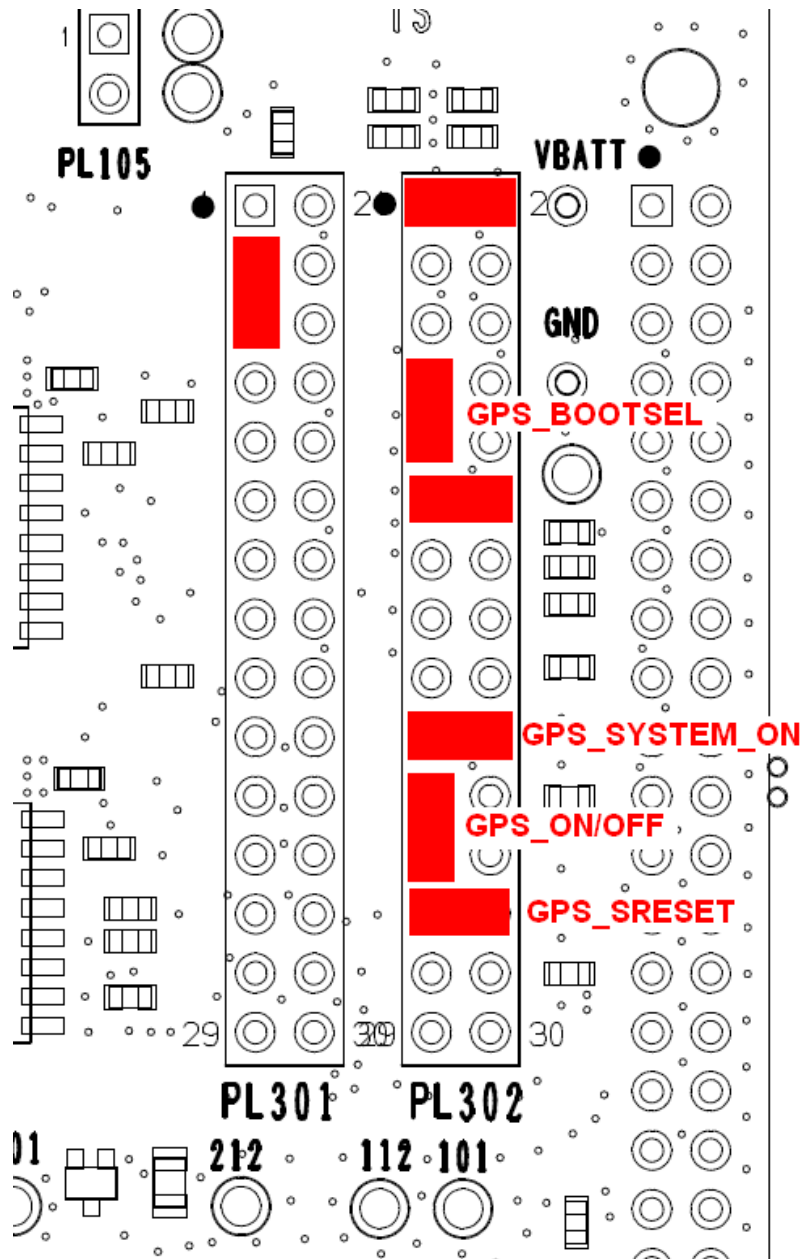

Settings for PL301 and PL302: internal host controlling



### 19.12.2. External host controlling configuration

The following settings on PL301 and PL302 allow selecting the external host configuration.

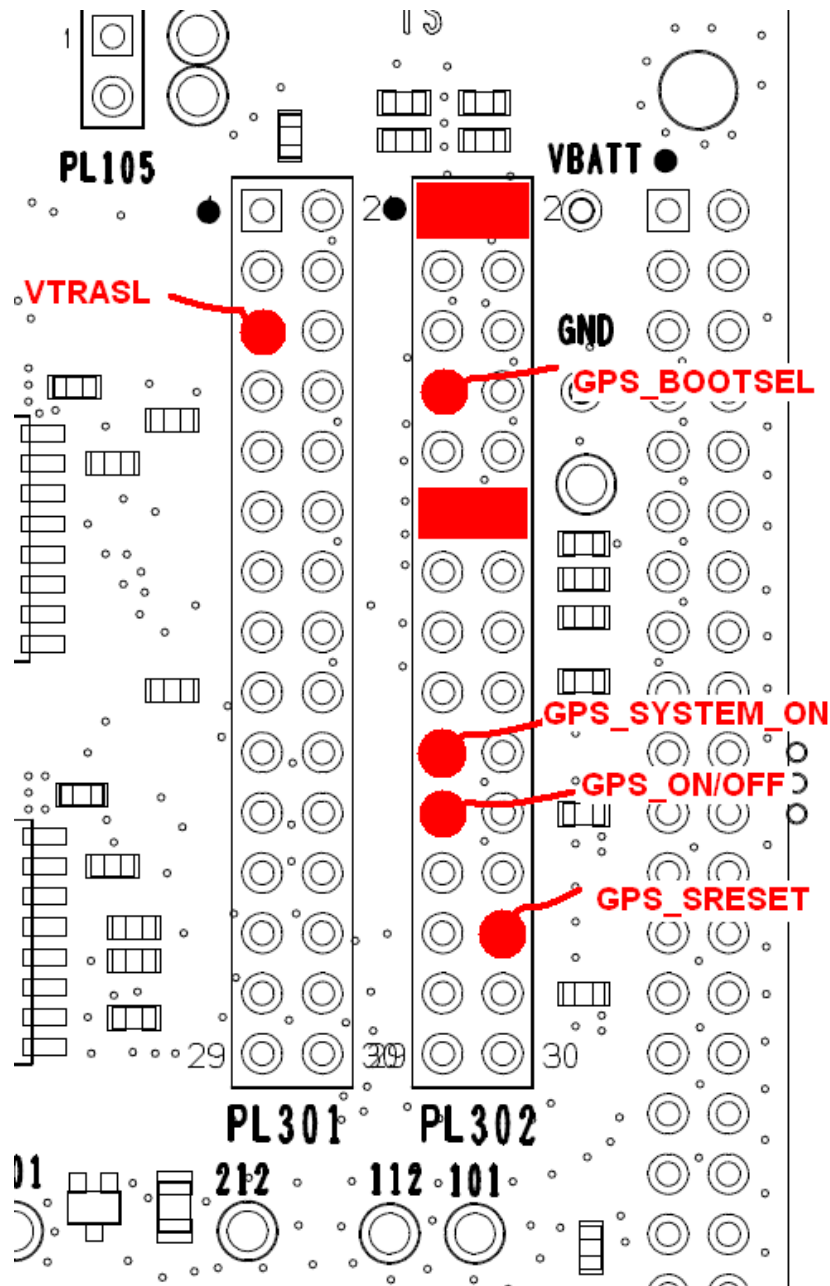

Settings for PL301 and PL302: external host.



### 19.13. GPS serial interface setting

GPS module has the capability to operate in serial UART mode, SPI mode or I2C mode depending upon how the JF2 GPIO6 and GPIO7 pins are strapped at power up. In the table below is shown the configuration set in PL302 to select the type of serial interface:

MODE	GPS GPIO n.6	GPS GPIO n.7
UART	1-2 pins shorted in PL302	Float
I2C	Float	15-16 pins shorted in PL302
SPI	Float	Float

If you connect JF2 module with GE865 module you must use UART configuration. Using an external host, if you want use I2C configuration, you need to plugging on PL302 two jumpers in positions 3-4 and 5-6 in order to connect pull-ups in SDA and SCL lines.

### 19.14. MEMS Sensor/EEPROM Interface

The DR I2C port of JF2 is used for connecting to MEMS sensors, such as accelerometer or magnetometer.

	GPS GPIO n.4	GPS GPIO n.0	GPS GPIO n.1
With sensor	Float	3-4 pins shorted in PL302	5-6 pins shorted in PL302
Without sensor	13-14 pins shorted in PL302	Float	Float

### 19.15. GPS power-on management

JF2 module power on/off can be controlled by an external host signal or it is possible to have the automatic module transition to the full power state by tying the SYSTEM-ON output to the ON-OFF input. The table below shows how to set these two options:

	Power Mode
10-12 and 19-21 pins shorted in PL302	Full power mode
11-12 pins shorted in PL302	ON/OFF controlled by an external host signal









## 20.1. Stand-alone setup

The interface can be used without EVK2 and in this case the following components have to be soldered to the board:

- GSM RESET button
- GSM ON/OFF button
- GPS STATUS led and its load resistor
- GSM STATUS led and its load resistor (both NO MOUNT)

## 20.2. Interface connectors

The following connectors are available:

- 2 male connectors (30 PTH pins each: PL300 and PL301), to connect external devices, user's applications, Telit extension boards, measurement equipment or other tools
- 2 female connectors (40 PTH pins each one: SO300 and SO301), to connect the interface to the EVK2 mother board circuits (power supply lines, serial in/out lines, audio in/out lines)
- 1 GSM RF connector (SMA Female: SO101)
- 1 GPS RF connector (SMA Female: SO201)
- 1 JTAG connector (PL100, not mounted)
- 1 male connector (3 PTH pins: PL200), to select an enable signal for the external GPS LNA,
- 1 male connector (12 PTH pins: PL302), to select one of the available configurations for the Serial and USB ports.
- 2 male connector (2 PTH pins: PL101, PL201), that can be used to insert an ammeter in series with the supply, in order to monitor respectively the current consumption of GL865 and SL869/JN3 modules.

## 20.3. Contents of the kit

Please check out the contents of your interface kit. If any of the following items is missing, contact your Telit supplier.

Description	Quantity
GL865 - SL869/JN3 INTERFACE	1
JUMPERS	10





## 20.1. Power supply

The GL865 module (but not the whole interface) receives its power supply from PL101: this jumper must always be plugged on except when a series measurement instrument is needed. The SL869/JN3 module receives its power supply from PL201: this jumper must always be plugged on except when a series measurement instrument is needed.

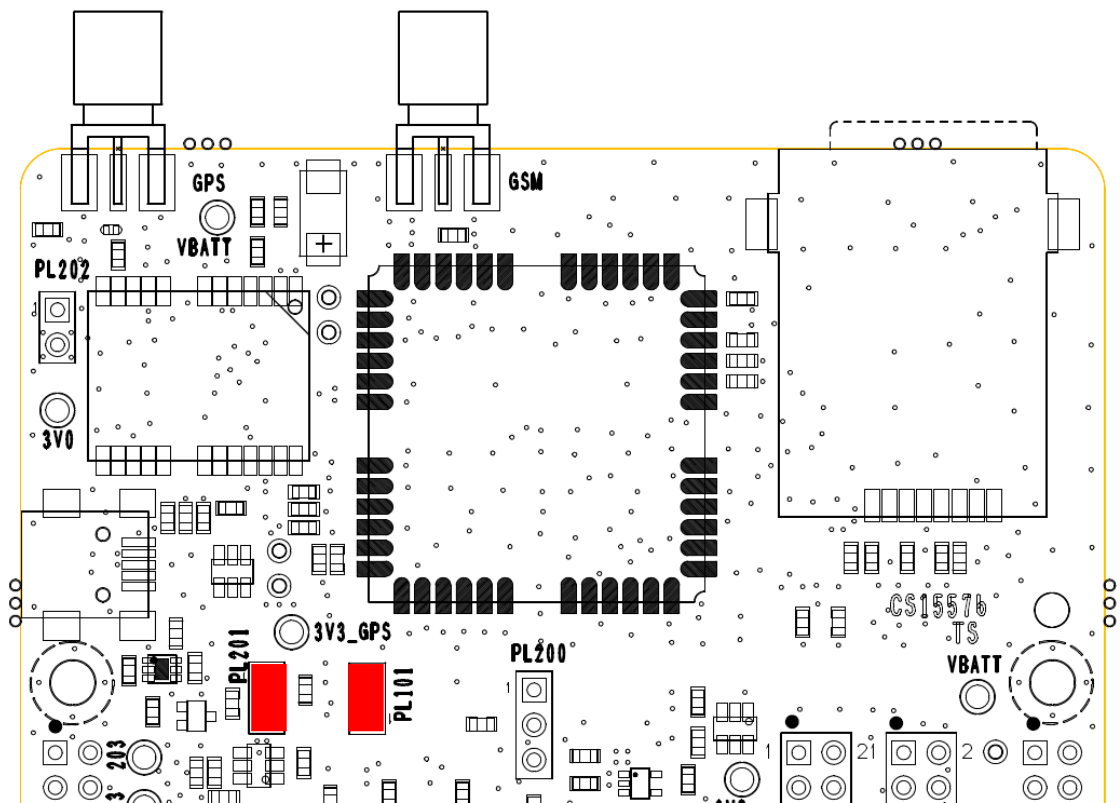

Jumper for VBATT.



## 20.2. GPS external LNA enable signal

The module contains an internal LNA for the GPS antenna.

The user can though decide to use an external LNA: this option is selected by means of a software command, which puts the internal LNA in a low gain mode and provides an additional signal to enable the external LNA. The interface can provide a bias for the external LNA by means of a jumper on PL202, and the user can choose whether to enable it by this signal or to leave it always enabled, by means of a jumper on PL200, as shown in the picture below.

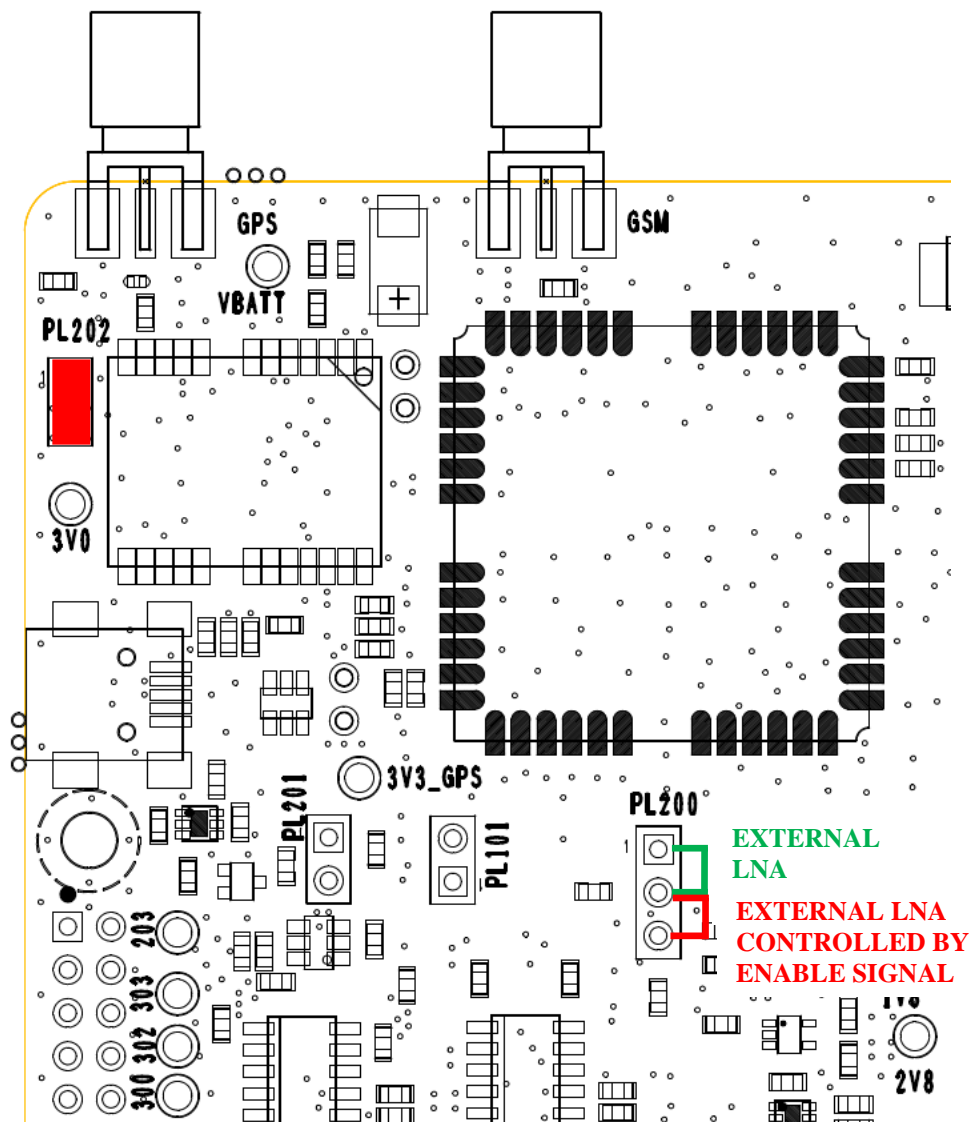

Jumper selection on PL200, PL202 for antenna bias.





## 20.4. GSM to Trace

This configuration connects the GSM to the RS232 serial connector of the EVK2.

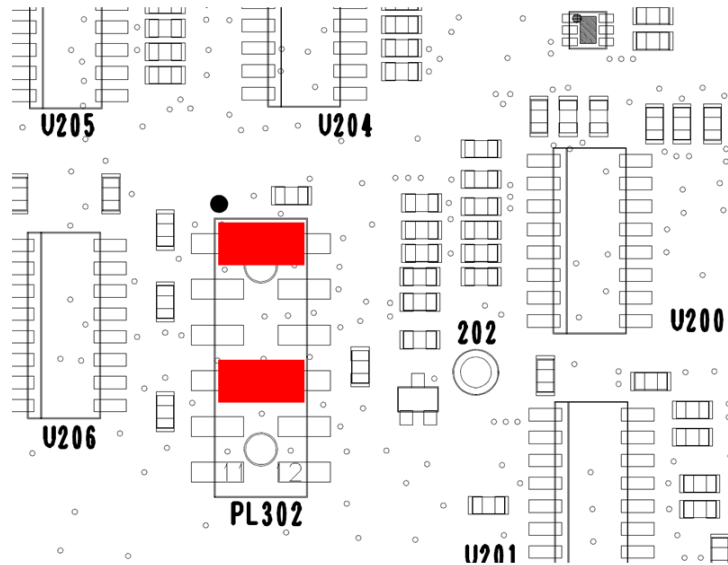

GSM to RS-232 (Trace) configuration

## 20.5. GPS to Trace

This configuration allows sending the GPS output to the Trace serial connector of EVK2 by means of transceivers

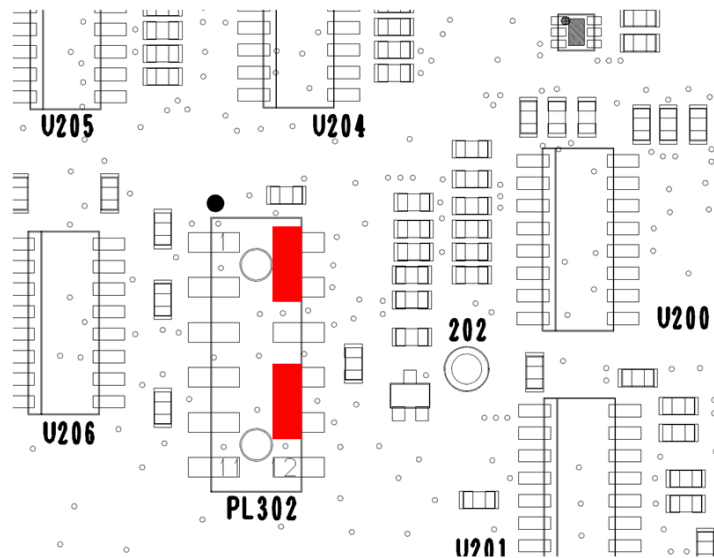

GPS to RS-232 (Trace) configuration



## 20.6. GSM to USB

This configuration connects the GSM to the USB connector of the EVK2.

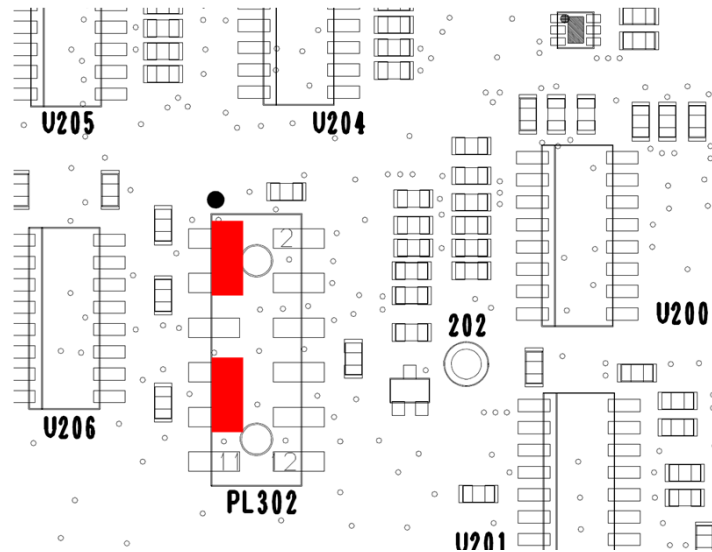

GSM to USB configuration

## 20.7. GPS to USB

This configuration connects the GPS to the USB connector of the EVK2.

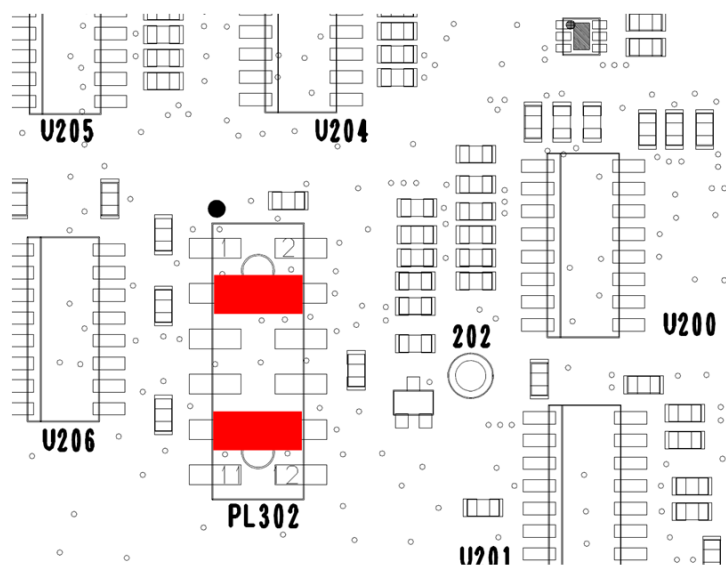

GPS to USB configuration





## 20.8. GPS to GSM (internal host controlling configuration)

This configuration directly connects the host GSM module to the GPS receiver, thus setting the GPS receiver in Controlled Mode.

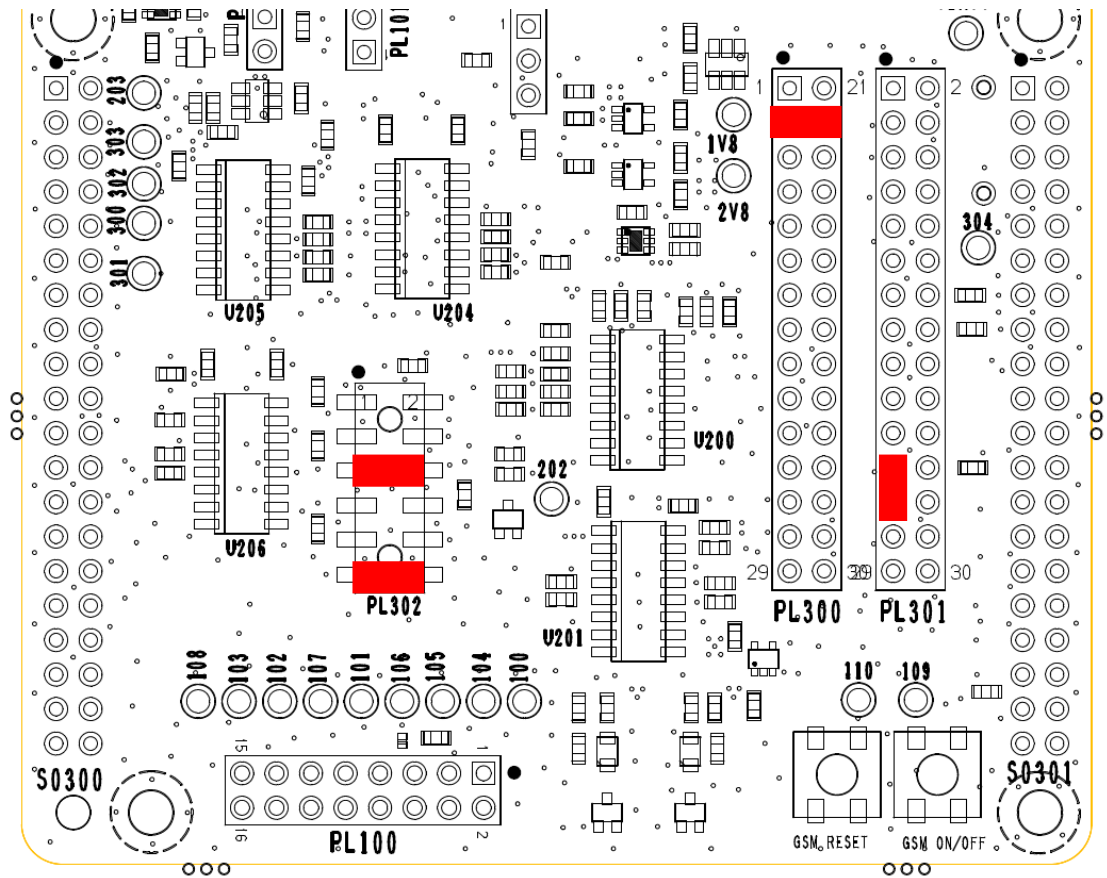

GPS to GSM configuration





## 20.9. GPIO settings

The interface allows choosing among different options for driving the GPS control signals:

- Using the GPIOs of the GSM module
- Using an external host
- Manually controlling the signals by plugging jumpers.

The last option is not available for every signal and every configuration; please refer to the schematics of the interface for more details.

The choice among the options can be made by PL300, PL301 and as detailed below.

### 20.9.1. Internal host controlling configuration

The following settings on PL300 and PL301 allow selecting the internal host configuration.

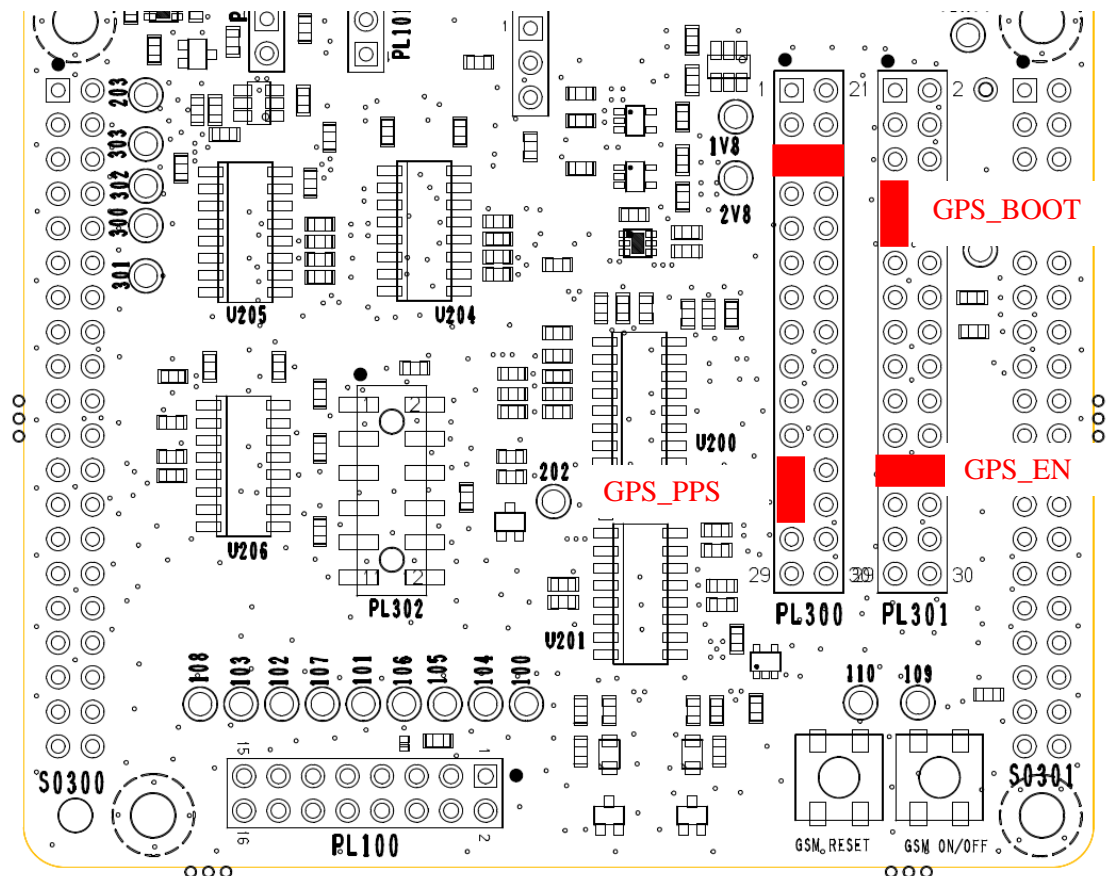

Settings for PL300 and PL301: internal host controlling



## 20.9.2. External host controlling configuration

The following settings on PL300 and PL301 allow selecting the external host configuration.

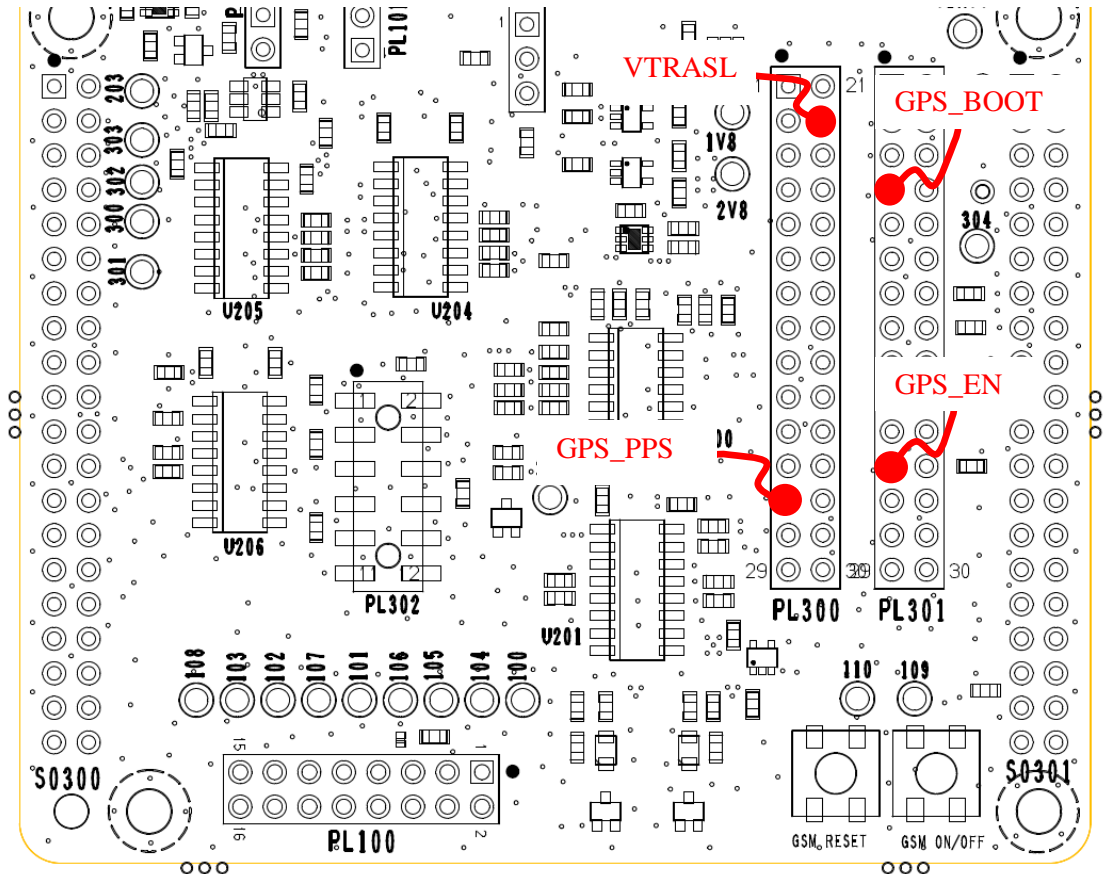

Settings for PL300 and PL301: external host.





## 21. GC864 Interface

This board allows easily interfacing the module with the EVK2 and testing its functionalities; any version of GC864 can be inserted.  
No settings are needed.

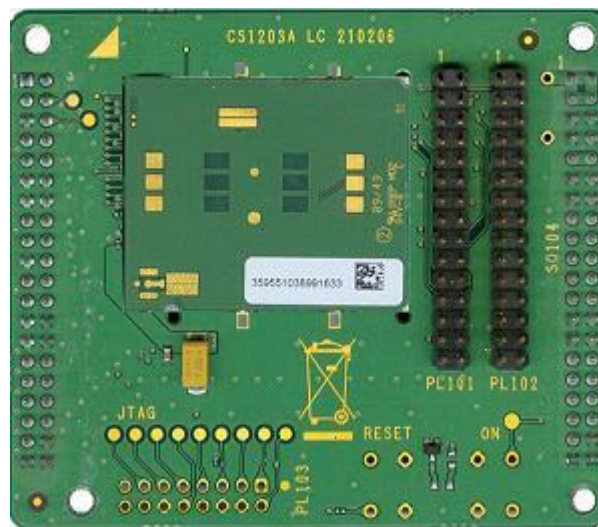

GC864 Interface Board

### 21.1. Stand-alone setup

If you need to use the interface out of EVK2 (*Stand-alone* setup) you have to mount also:

- the SIMCARD Holder;
- the RESET Button
- the ON Button;
- the STATUS LED and its load resistance.













## 23.2. Interface connectors

The following connectors are available:

2 male connectors (30 PTH pins each one: PL102, PL103), by which it is possible to connect external devices, user's application, Telit extension boards, measurements equipment or other tools;

2 female connectors (40 PTH pins each one: SO101, SO102), to connect the interface to the EVK2 mother board circuits (power supply lines, serial in/out lines, audio in/out lines);

## 23.3. Content of the kit

Please check out the contents of your interface kit; if any of the items is missing, please contact your supplier.

Description	Quantity
GE865 INTERFACE	1









## 24.2. Interface connectors

The following connectors are available:

2 male connectors (30 PTH pins each one: PL102, PL103), by which it is possible to connect external devices, user's application, Telit extension boards, measurements equipment or other tools;

2 female connectors (40 PTH pins each one: SO101, SO102), to connect the interface to the EVK2 mother board circuits (power supply lines, serial in/out lines, audio in/out lines);

## 24.3. Content of the kit

Please check out the contents of your interface kit; if any of the items is missing, please contact your supplier.

Description	Quantity
GL865 INTERFACE	1







## 26. HE910 family Interface

This board allows easily interfacing the HE910 modules with the EVK2 and testing their functionalities;  
No settings are needed.



HE910 Interface Board





## 26.1. Stand-alone setup

The Jumper setting and the assembled components are ready permitting the standalone use.

## 26.2. Interface connectors

The following connectors are available:

2 female connectors (40 PTH pins each one: SO101, SO104), to connect the interface to the EVK2 mother board circuits (power supply lines, serial in/out lines, audio in/out lines);

1 USB connector (SO202) related to the HE910 USB 2.0 port.

3 RF connectors for GSM/UMTS Antenna (SO103), Receiver Diversity Antenna (SO105) and GPS Antenna (SO102)

1 SIM Holder (SO204)

A group of Male connectors (PL301, PL302, PL303, PL304, PL102, PL203, PL204) that provide the additional signals (i.e. GPIOs) and could select the functions by Jumper setting (see the related document section/schematic for this).

The following picture is showing the connector's positions and the default settings for the Jumpers.

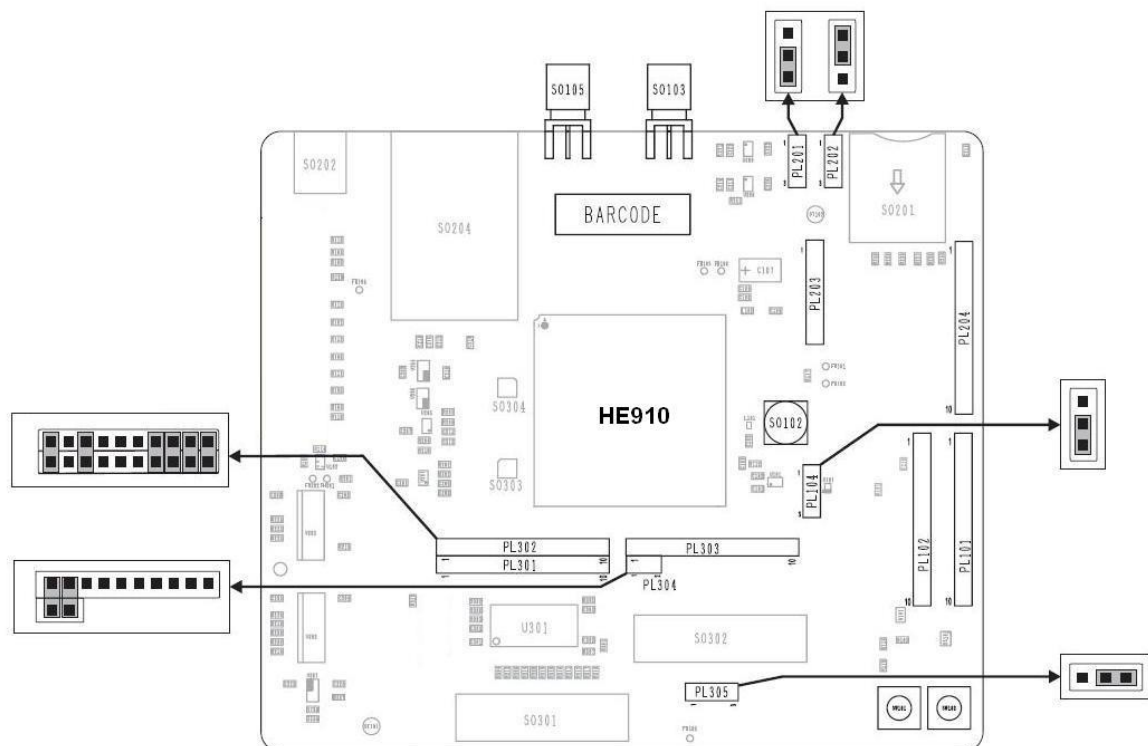



## 26.3. Antenna connectors

### 26.3.1. GSM/UMTS Antenna connector

A GSM/UMTS compatible antenna (Refer to the product's HW user guide) antenna must be connected to SO103.

### 26.3.2. Receiver Diversity Antenna connector

A GSM/UMTS compatible antenna (Refer to the product's HW user guide) antenna could be connected to SO105.

### 26.3.3. GPS antenna connector

A GPS antenna could be connected to SO102. Please refer to the product's HW user guide for the proper type.

The GPS Antenna (if an active type) could be supplied with a dedicated LDO (3V DC) that could be set in the following way using the Jumpers on PL104.

LDO Enabled by the HE910 Module.

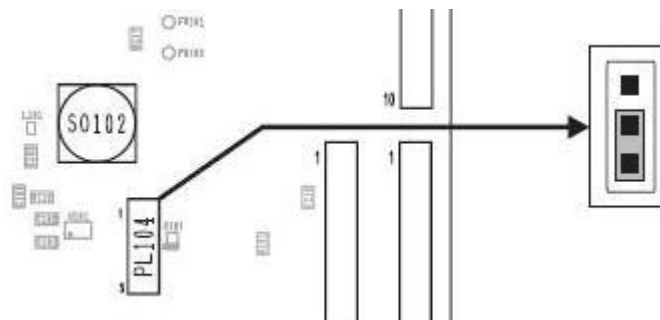

LDO Always Enabled

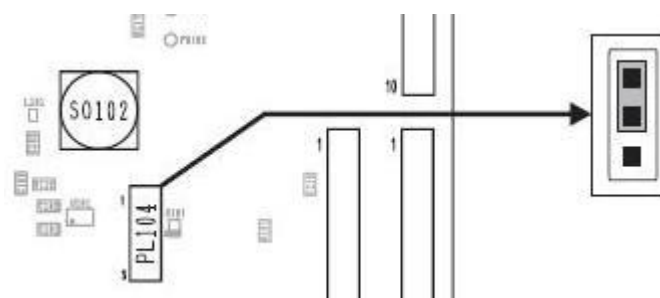

#### **WARNING:**

Don't connect a *GSM/UMTS* antenna on this connector





## 26.4.2. PL303/PL304/PL305

The connectors are carrying the following signals:

PL303		
Pin#	Pin Name	Description
1	TX_AUX	Auxiliary serial port (TX)
2	RX_AUX	Auxiliary serial port (RX)
3	SPI_CLK	SPI
4	SPI_MRDY	SPI
5	SPI_SRDY	SPI
6	GPIO_08	
7	GPIO_09	
8	GPIO_10	
9	RESERVED	
10	NC	

PL304		
Pin#	Pin Name	Description
1	TX_AUX	Jumper to EVK2
2	RX_AUX	Jumper to EVK2

PL305		
Pin#	Pin Name	Description
1	RESERVED	-
2	VDD_IO	Input pin for the bus supply
3	VIO_1V8	VIO supply at 1.8V



### 26.4.3. PL102

The connector is providing the following signals:

PL102		
Pin#	Pin Name	Description
1	VAUX/PWRMON	Auxiliary supply / Power On Indicator
2	VRTC	RTC Backup
3	RESERVED	
4	RESERVED	
5	RESERVED	
6	GPIO_05	GPIO
7	RESERVED	
8	RESERVED	
9	RESERVED	
10	GND	

### 26.4.4. ON\_OFF & UNCONDITIONAL SHUTDOWN BUTTONS

The 2 Buttons present on the Interface should be used to control the Power ON and UNCONDITIONAL SHUTDOWN lines of the module.

The 2 Buttons on the EVK2 could not be used with the HE910 Interface.

## 26.5. Content of the kit

Please check out the contents of your interface kit; if any of the items is missing, please contact your supplier.

Description	Quantity
HE910 INTERFACE	1
MINI USB CABLE	1











## 27.3.2. PL303/PL304/PL305

The connectors are carrying the following signals:

<b>PL303</b>		
<b>Pin#</b>	<b>Pin Name</b>	<b>Description</b>
1	TX_AUX	Auxiliary serial port (TX)
2	RX_AUX	Auxiliary serial port (RX)
3	SPI_CLK	SPI
4	SPI_MRDY	SPI
5	SPI_SRDY	SPI
6	GPIO_08	
7	GPIO_09	
8	GPIO_10	
9	RESERVED	
10	NC	

<b>PL304</b>		
<b>Pin#</b>	<b>Pin Name</b>	<b>Description</b>
1	TX_AUX	Jumper to EVK2
2	RX_AUX	Jumper to EVK2

<b>PL305</b>		
<b>Pin#</b>	<b>Pin Name</b>	<b>Description</b>
1	RESERVED	-
2	VDD_IO	Input pin for the bus supply
3	VIO_1V8	VIO supply at 1.8V









## 28.1. Stand-alone setup

The Jumper setting and the assembled components are ready permitting the standalone use.

## 28.2. Interface connectors

The following connectors are available:

- 2 female connectors (40 PTH pins each one: SO101, SO104), to connect the interface to the EVK2 mother board circuits (power supply lines, serial in/out lines, audio in/out lines);
- 1 USB connector (SO202) related to the GE910 USB 2.0 port.
- 1 RF connectors for GSM/GPRS Antenna (SO103),
- 1 SIM Holder (SO204)

A group of Male connectors (PL301, PL302, PL303, PL304, PL305, PL102, PL203) that provide the additional signals (i.e. GPIOs) and could select the functions by Jumper setting (see the related document section/schematic for this).

The following picture is showing the connector's positions and the default settings for the Jumpers.

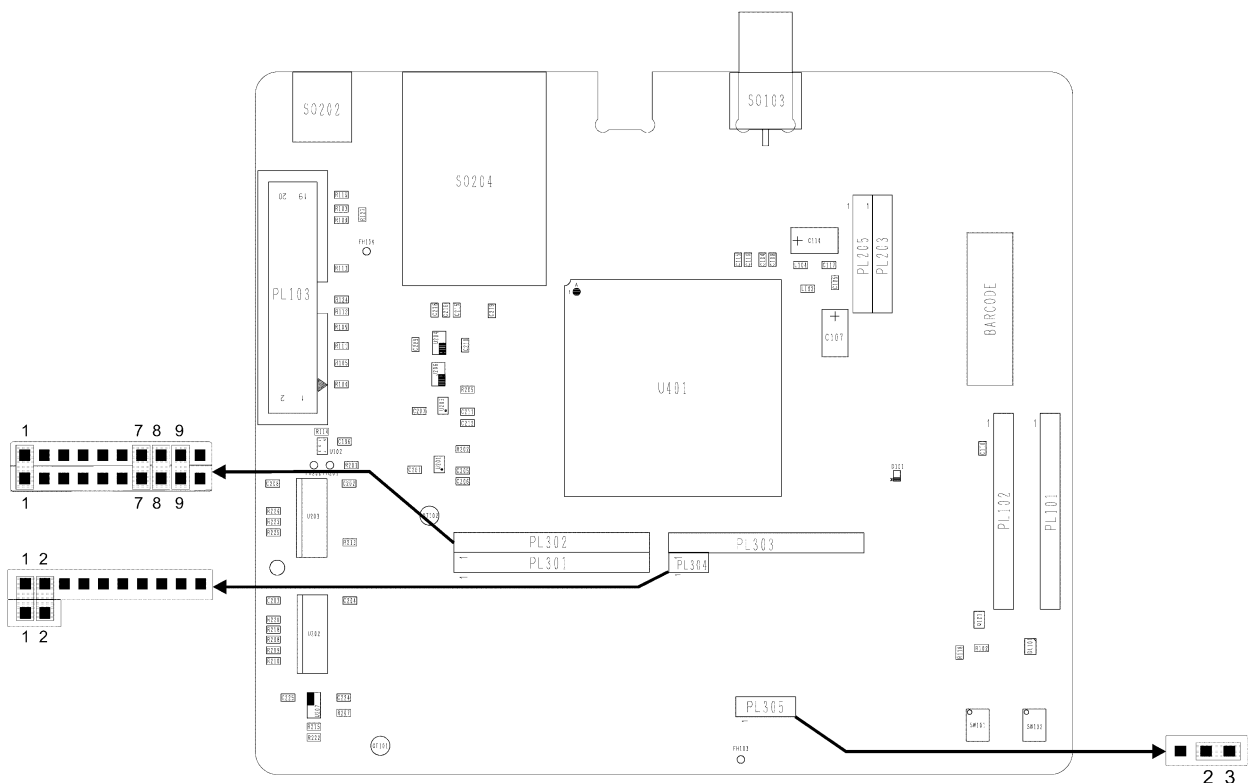



### 28.4.2. PL303/PL304

The connectors are carrying the following signals:

PL303		
Pin#	Pin Name	Description
1	TX_AUX	Auxiliary serial port (TX)
2	RX_AUX	Auxiliary serial port (RX)
3	RESERVED	
4	RESERVED	
5	RESERVED	
6	GPIO_08	
7	GPIO_09	
8	GPIO_10	
9	RESERVED	
10	NC	

PL304		
Pin#	Pin Name	Description
1	TX_AUX	Jumper to EVK2
2	RX_AUX	Jumper to EVK2

### 28.4.3. PL102

The connector is providing the following signals:

PL102		
Pin#	Pin Name	Description
1	VAUX/PWRMON	Auxiliary supply / Power On Indicator
2	VRTC	RTC Backup
3	RESERVED	
4	RESERVED	
5	RESERVED	
6	GPIO_05	GPIO
7	RESERVED	
8	RESERVED	
9	RESERVED	
10	GND	





## 29. GE910-GNSS Interface

This board allows easily interfacing the GE910-GNSS module with the EVK2 and testing their functionalities;  
No settings are needed.

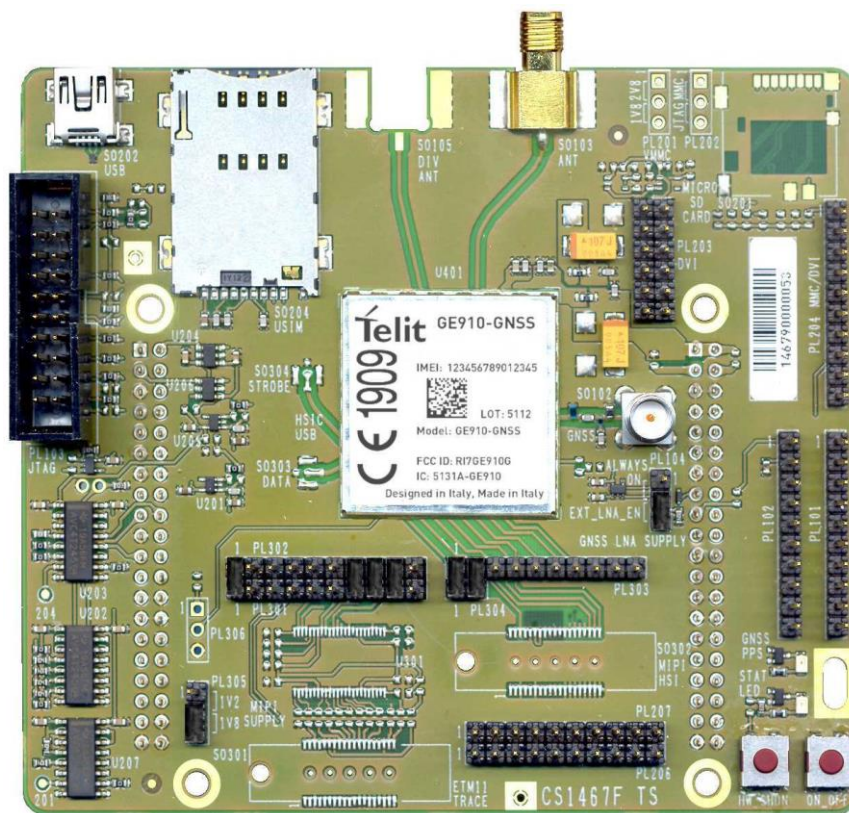

GE910-GNSS Interface Board

















## 30. GE910-QUAD V3 Interface

This board allows easily interfacing the GE910-QUAD V3 module with the EVK2 and testing their functionalities.

No settings are needed.

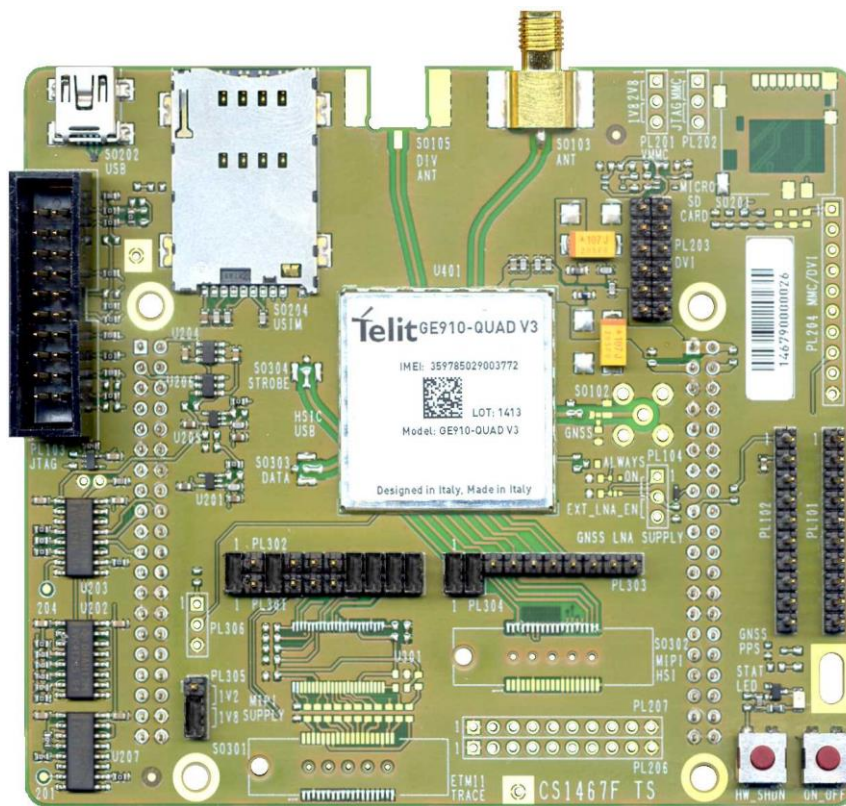

GE910 Interface Board



## 30.1. Stand-alone setup

The Jumper setting and the assembled components are ready permitting the standalone use.

## 30.2. Interface connectors

The following connectors are available:

2 female connectors (40 PTH pins each one: SO101, SO104), to connect the interface to the EVK2 mother board circuits (power supply lines, serial in/out lines, audio in/out lines);

1 USB connector (SO202) related to the GE910 USB 2.0 port.

1 RF connectors for GSM/GPRS Antenna (SO103),

1 SIM Holder (SO204)

A group of Male connectors (PL301, PL302, PL303, PL304, PL305, PL102, PL203) that provide the additional signals (i.e. GPIOs) and could select the functions by Jumper setting (see the related document section/schematic for this).

The following picture is showing the connector's positions and the default settings for the Jumpers.

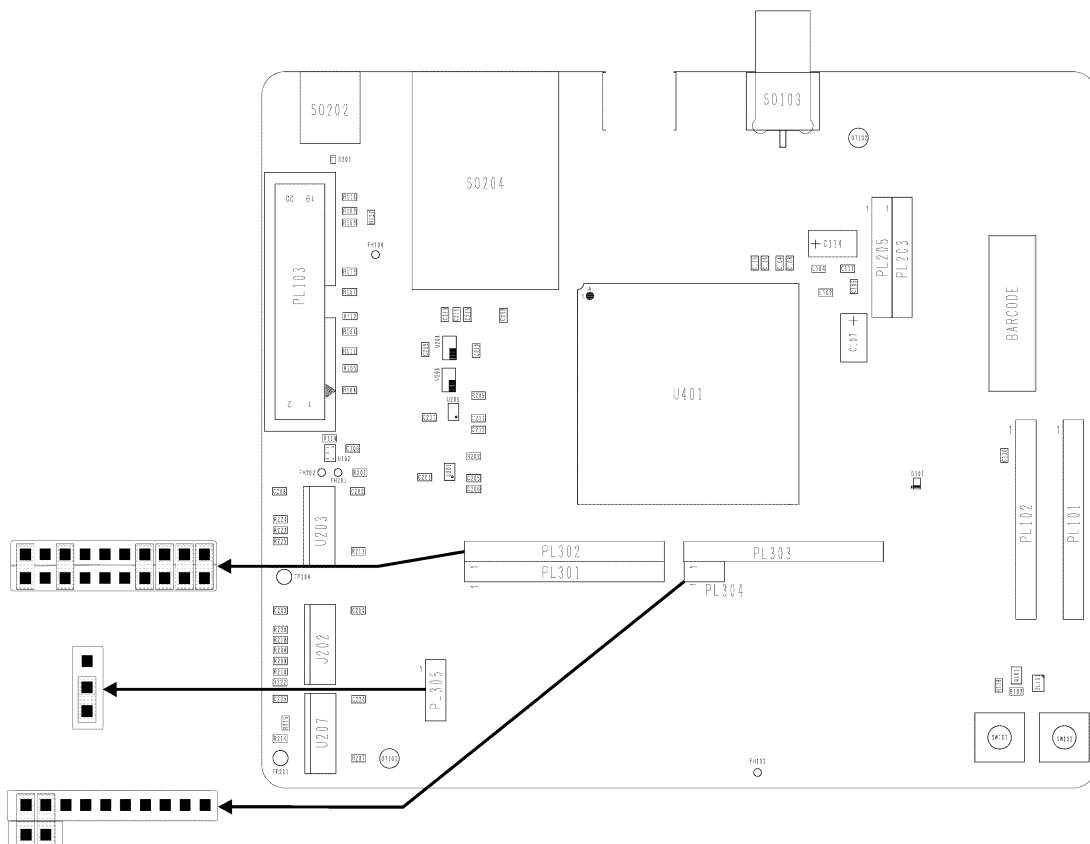



### 30.4.2. PL303/PL304

The connectors are carrying the following signals:

PL303		
Pin#	Pin Name	Description
1	TX_AUX	Auxiliary serial port (TX)
2	RX_AUX	Auxiliary serial port (RX)
3	RESERVED	
4	RESERVED	
5	RESERVED	
6	GPIO_08	
7	GPIO_09	
8	GPIO_10	
9	RESERVED	
10	NC	

PL304		
Pin#	Pin Name	Description
1	TX_AUX	Jumper to EVK2
2	RX_AUX	Jumper to EVK2

### 30.4.3. PL102

The connector is providing the following signals:

PL102		
Pin#	Pin Name	Description
1	VAUX/PWRMON	Auxiliary supply / Power On Indicator
2	VRTC	RTC Backup
3	RESERVED	
4	RESERVED	
5	RESERVED	
6	GPIO_05	GPIO
7	RESERVED	
8	RESERVED	
9	RESERVED	
10	GND	



### 30.4.4. ON\_OFF & UNCONDITIONAL SHUTDOWN BUTTONS

The 2 Buttons present on the Interface should be used to control the Power ON and UNCONDITIONAL SHUTDOWN lines of the module.

The 2 Buttons on the EVK2 could not be used with the GE910 Interface.

### 30.5. Content of the kit

Please check out the contents of your interface kit; if any of the items is missing, please contact your supplier.

Description	Quantity
GE910 INTERFACE	1
MINI USB CABLE	1





## 31. DE910 family Interface

This board allows easily interfacing the DE910 modules with the EVK2 and testing their functionalities;  
No settings are needed.



DE910 Interface Board



### 31.1. Stand-alone setup

The Jumper setting and the assembled components are ready permitting the standalone use.

### 31.2. Interface connectors

The following connectors are available:

- 2 female connectors (40 PTH pins each one: SO101, SO104), to connect the interface to the EVK2 mother board circuits (power supply lines, serial in/out lines, audio in/out lines);
- 1 USB connector (SO202) related to the DE910 USB 2.0 port.
- 3 RF connectors for CDMA Antenna (SO103), Receiver Diversity Antenna (SO105) and GPS Antenna (SO102)
- 1 RUIM Holder (SO204)

A group of Male connectors (PL301, PL302, PL303, PL304, PL102, PL203, PL204) that provide the additional signals (i.e. GPIOs) and could select the functions by Jumper setting (see the related document section/schematic for this).

The following picture is showing the connector's positions and the default settings for the Jumpers.

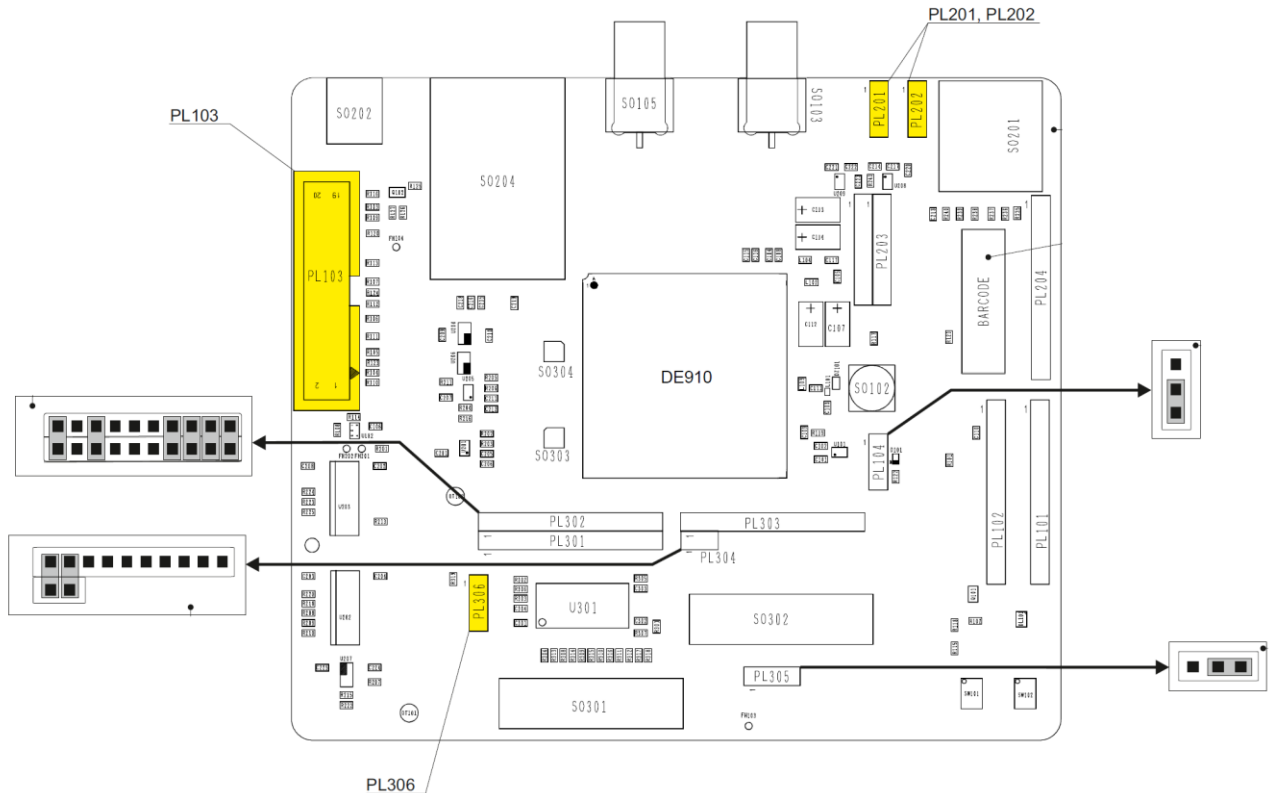

### 31.3. Antenna connectors

#### 31.3.1. CDMA Antenna connector

A CDMA compatible antenna (Refer to the product’s HW user guide) must be connected to SO103.

#### 31.3.2. Receiver Diversity Antenna connector

A CDMA compatible antenna (Refer to the product’s HW user guide) could be connected to SO105.

#### 31.3.3. GPS antenna connector

A GPS antenna could be connected to SO102. Please refer to the product’s HW user guide for the proper type.  
The GPS Antenna (if an active type) could be supplied with a dedicated LDO (3V DC) that could be set in the following way using the Jumpers on PL104.

LDO Enabled by the DE910 Module.

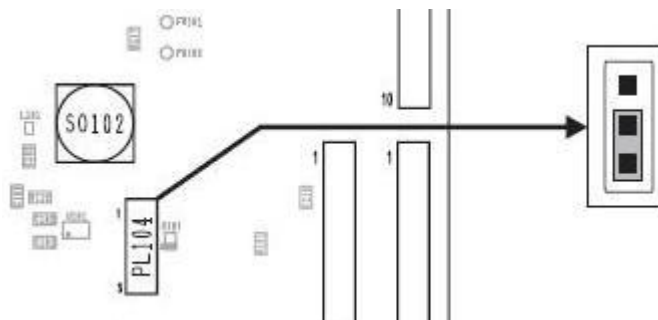

LDO Always Enabled

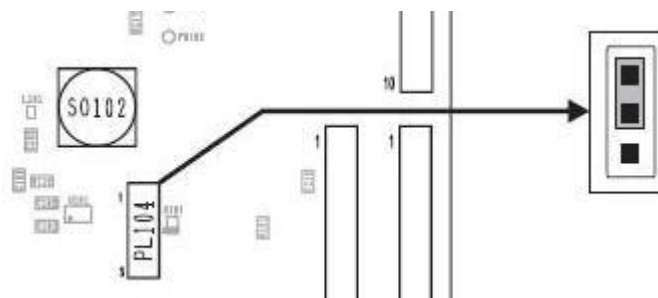

#### WARNING:

Don't connect a CDMA antenna on this connector



## 31.4. Expansion Connectors

### 31.4.1. PL301/PL302

The connectors are carrying the following signals:

PL301		
Pin#	Pin Name	Description
1	STAT_LED	Status Led
2	NC	
3	RESERVED	
4	NC	
5	NC	
6	NC	
7	C125/RING	
8	C107/DSR	
9	C109/DCD	
10	RESERVED	

PL302		
Pin#	Pin Name	Description
1	GPIO_01	Default function is Status Led
2	GPIO_02	
3	GPIO_03	
4	GPIO_04	
5	GPIO_06	
6	GPIO_07	
7	C125/RING	Jumper to EVK2
8	C107/DSR	Jumper to EVK2
9	C109/DCD	Jumper to EVK2
10	RESERVED	Jumper to EVK2



### 31.4.2. PL303/PL304/PL305

The connectors are carrying the following signals:

PL303		
Pin#	Pin Name	Description
1	TX_AUX	Auxiliary serial port (TX)
2	RX_AUX	Auxiliary serial port (RX)
3	RESERVED	
4	RESERVED	
5	RESERVED	
6	GPIO_08	
7	GPIO_09	
8	GPIO_10	
9	RESERVED	
10	NC	

PL304		
Pin#	Pin Name	Description
1	TX_AUX	Jumper to EVK2
2	RX_AUX	Jumper to EVK2

PL305		
Pin#	Pin Name	Description
1	RESERVED	-
2	VDD_IO	Input pin for the bus supply
3	VIO_1V8	VIO supply at 1.8V





### 31.4.3. PL102

The connector is providing the following signals:

<b>PL102</b>		
<b>Pin#</b>	<b>Pin Name</b>	<b>Description</b>
1	VAUX/PWRMON	Auxiliary supply / Power On Indicator
2	VRTC	RTC Backup
3	RESERVED	
4	RESERVED	
5	RESERVED	
6	GPIO_05	GPIO
7	RESERVED	
8	RESERVED	
9	RESERVED	
10	GND	

### 31.4.4. ON\_OFF & UNCONDITIONAL SHUTDOWN BUTTONS

The 2 Buttons present on the Interface should be used to control the Power ON and UNCONDITIONAL SHUTDOWN lines of the module.

The 2 Buttons on the EVK2 could not be used with the DE910 Interface.

## 31.5. Content of the kit

Please check out the contents of your interface kit; if any of the items is missing, please contact your supplier.

Description	Quantity
DE910 INTERFACE	1
MINI USB CABLE	1



## 32. CE910 family Interface

This board allows easily interfacing the CE910 modules with the EVK2 and testing their functionalities.

No settings are needed.



CE910 Interface Board



## 32.1. Stand-alone setup

The Jumper setting and the assembled components are ready permitting the standalone use.

## 32.2. Interface connectors

The following connectors are available:

- 2 female connectors (40 PTH pins each one: SO101, SO104), to connect the interface to the EVK2 mother board circuits (power supply lines, serial in/out lines, audio in/out lines);
- 1 USB connector (SO202) related to the CE910 USB 2.0 port.
- 1 RF connectors for CDMA Antenna (SO103)
- 1 RUIM Holder (SO204)

A group of Male connectors (PL301, PL302, PL303, PL304, PL102, PL203, PL204) that provide the additional signals (i.e. GPIOs) and could select the functions by Jumper setting (see the related document section/schematic for this).

The following picture is showing the connector's positions and the default settings for the Jumpers.

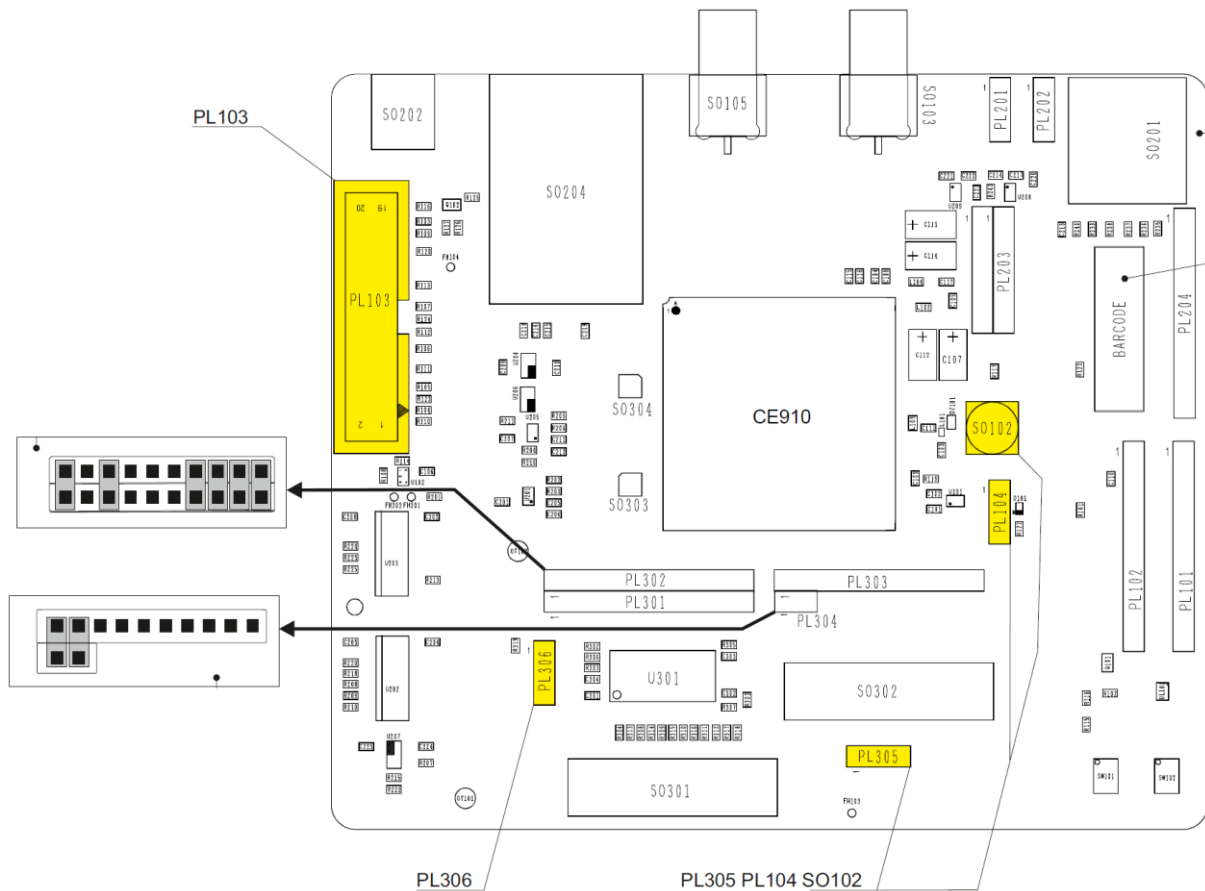

## 32.3. Antenna connectors

### 32.3.1. CDMA Antenna connector

A CDMA compatible antenna (Refer to the product's HW user guide) must be connected to SO103.

## 32.4. Expansion Connectors

### 32.4.1. PL301/PL302

The connectors are carrying the following signals:

PL301		
Pin#	Pin Name	Description
1	STAT_LED	Status Led
2	NC	
3	RESERVED	
4	NC	
5	NC	
6	NC	
7	C125/RING	
8	C107/DSR	
9	C109/DCD	
10	RESERVED	

PL302		
Pin#	Pin Name	Description
1	GPIO_01	Default function is Status Led
2	GPIO_02	
3	GPIO_03	
4	GPIO_04	
5	GPIO_06	
6	GPIO_07	
7	C125/RING	Jumper to EVK2
8	C107/DSR	Jumper to EVK2
9	C109/DCD	Jumper to EVK2
10	RESERVED	Jumper to EVK2



### 32.4.2. PL303/PL304

The connectors are carrying the following signals:

PL303		
Pin#	Pin Name	Description
1	TX_AUX	Auxiliary serial port (TX)
2	RX_AUX	Auxiliary serial port (RX)
3	RESERVED	
4	RESERVED	
5	RESERVED	
6	GPIO_08	
7	GPIO_09	
8	GPIO_10	
9	RESERVED	
10	NC	

PL304		
Pin#	Pin Name	Description
1	TX_AUX	Jumper to EVK2
2	RX_AUX	Jumper to EVK2

### 32.4.3. PL102

The connector is providing the following signals:

PL102		
Pin#	Pin Name	Description
1	VAUX/PWRMON	Auxiliary supply / Power On Indicator
2	VRTC	RTC Backup
3	RESERVED	
4	RESERVED	
5	RESERVED	
6	GPIO_05	GPIO
7	RESERVED	
8	RESERVED	
9	RESERVED	
10	GND	





### 32.4.4. ON\_OFF & UNCONDITIONAL SHUTDOWN BUTTONS

The 2 Buttons present on the Interface should be used to control the Power ON and UNCONDITIONAL SHUTDOWN lines of the module.

The 2 Buttons on the EVK2 could not be used with the CE910 Interface.

### 32.5. Content of the kit

Please check out the contents of your interface kit; if any of the items is missing, please contact your supplier.

Description	Quantity
CE910 INTERFACE	1
MINI USB CABLE	1



### 33. GL865 V3 Interface

This board allows easily interfacing the GL865-DUAL V3 modules with the EVK2 and testing their functionalities.

No settings are needed.

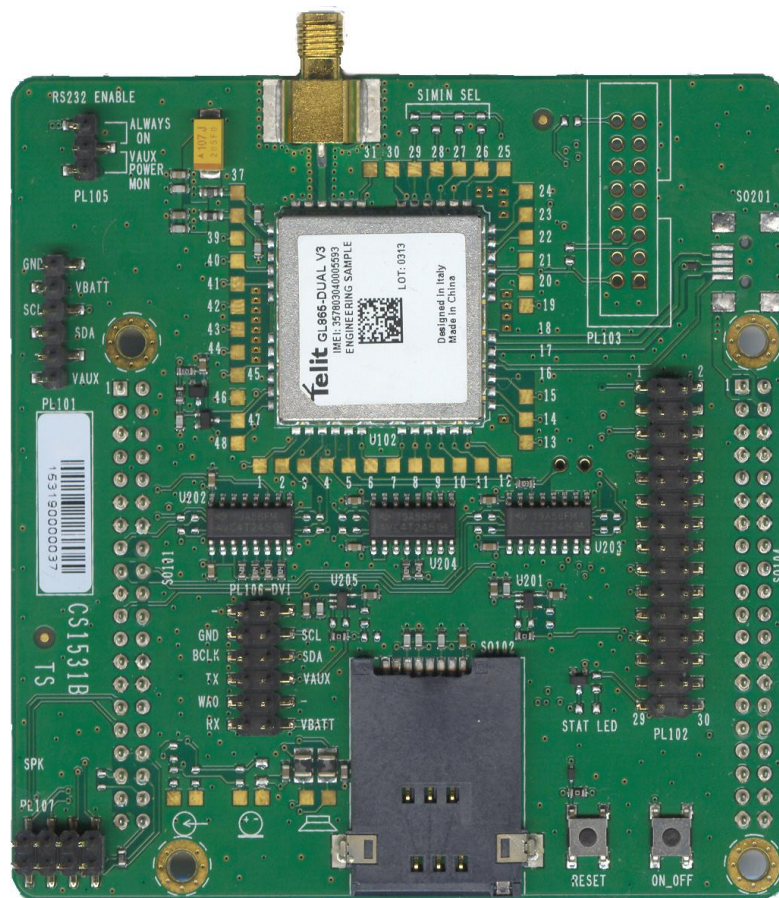

GL865 V3 Interface Board

#### 33.1. Stand-alone setup

The Jumper setting and the assembled components are ready permitting the standalone use.



## 33.2. Interface connectors

The following connectors are available:

1 male connector (30 SMT pins each one: PL102), by which it is possible to connect external devices, user's application, Telit extension boards, measurements equipment or other tools;  
2 female connectors (40 PTH pins each one: SO101, SO104), to connect the interface to the EVK2 mother board circuits (power supply lines, serial in/out lines, audio in/out lines);

1 RF connectors for GSM Antenna (SO103)

1 SIM Holder (SO102)

A group of Male connectors (PL101, PL105, PL106, PL107) that provide the additional signals (i.e. GPIOs) and could select the functions by Jumper setting (see the related document section/schematic for this).

The following picture is showing the connector's positions and the default settings for the Jumpers.

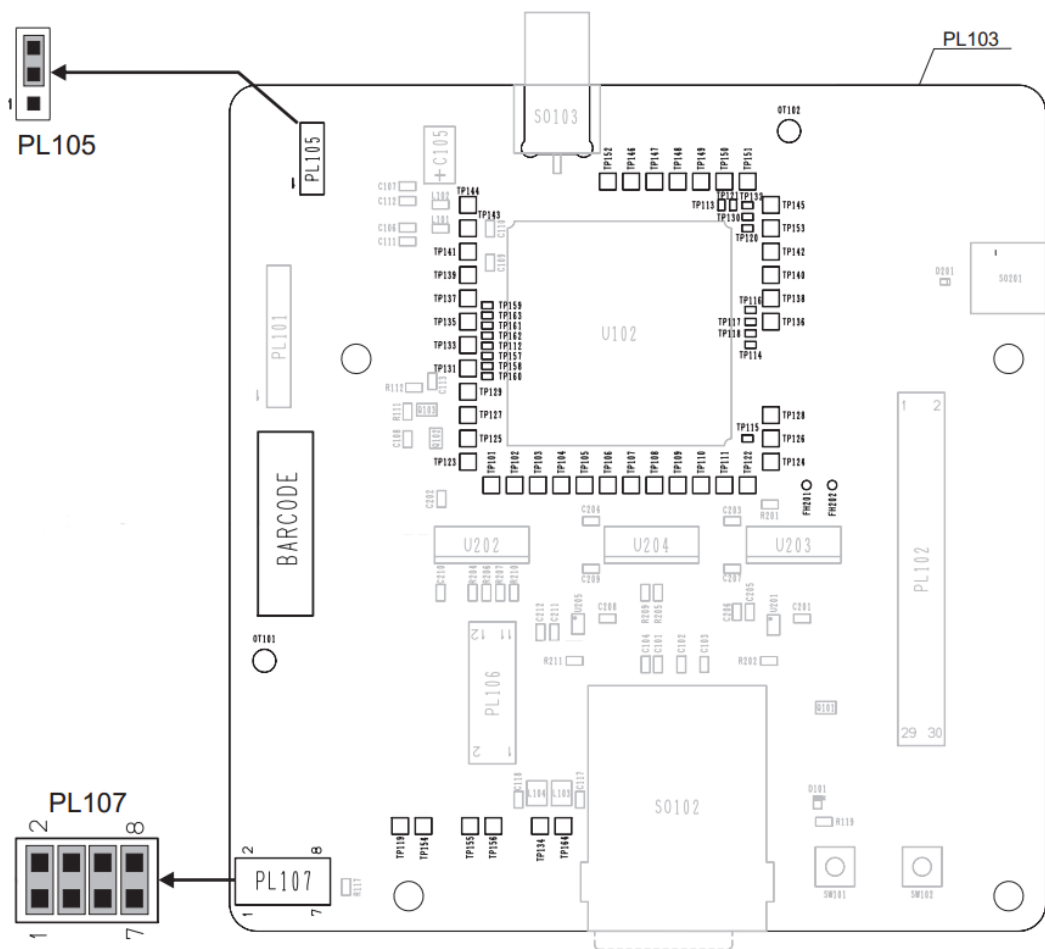



## 34. LE920 Interface

This board allows easily interfacing the LE920 module with the EVK2 and testing their functionalities.

No settings are needed.



LE920 Interface Board



## 34.1. Stand-alone setup

The Jumper setting and the assembled components are ready permitting the standalone use.

## 34.2. Interface connectors

The following connectors are available:

2 female connectors (40 PTH pins each one: SO101, SO104), to connect the interface to the EVK2 mother board circuits (power supply lines, serial in/out lines, audio in/out lines);

1 USB connector (SO202) related to the LE920 USB 2.0 port.

3 RF connectors for Main, Diversity, and GPS Antenna (SO105, SO107, SO108),

1 SIM Holder (SO204)

A group of Male connectors (PL102, PL104), that provide the additional signals

The following picture is showing the connector's positions and the default settings for the Jumpers.

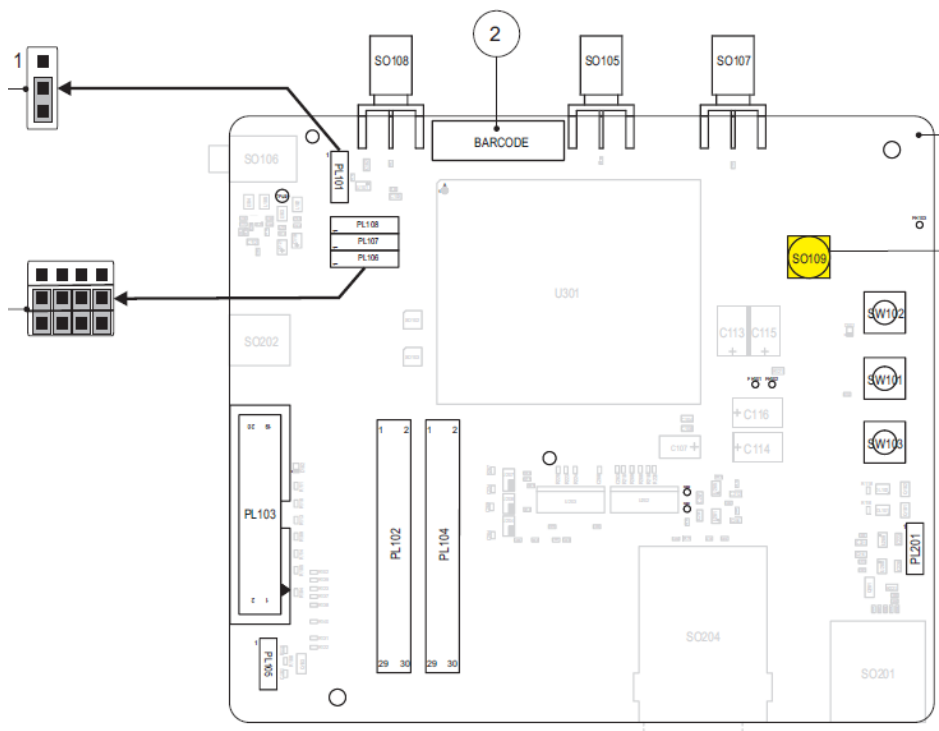



## 34.3. Antenna connectors

### 34.3.1. Main Antenna connector

A LTE/HSPA/GSM/GPRS compatible antenna (Refer to the product's HW user guide) antenna must be connected to SO105.

### 34.3.2. Diversity Antenna connector

A LTE/HSPA diversity (secondary) compatible antenna (Refer to the product's HW user guide) antenna must be connected to SO107.

### 34.3.3. GPS Antenna connector

A GPS compatible antenna (Refer to the product's HW user guide) antenna must be connected to SO108.

## 34.4. Expansion Connectors

### 34.4.1. PL102/PL104

The connectors are carrying the following signals:

PL102		
Pin#	Pin Name	Description
1	DVI RX	Digital Audio
2	DVI TX	Digital Audio
3	DVI_WA0	Digital Audio
4	DVI_CLK	Digital Audio
5	GND	
6	REF_CLK	
7	GND	
8	RESERVED	
9	RESERVED	
10	RESERVED	
11	RESERVED	
12	GND	
13	NC	
14	NC	
15	GND	
16	GND	
17	RESERVED	
18	NC	
19	RESERVED	



20	TGPIO_04	
21	RESERVED	
22	RESERVED	
23	RESERVED	
24	RESERVED	
25	TGPIO_01	
26	RESERVED	
27	RESERVED	
28	NC	
29	GND	
30	RESERVED	

		PL104
Pin#	Pin Name	Description
1	TGPIO_05	
2	TGPIO_07	
3	NC	
4	NC	
5	TGPIO_08	
6	TGPIO_09	
7	TGPIO_10	
8	TGPIO_03	
9	RESERVED	
10	RESERVED	
11	RESERVED	
12	TGPIO_06	
13	RESERVED	
14	RESERVED	
15	NC	
16	VAUX	1.8V
17	NC	
18	VRTC	
19	ADC1	
20	ADC2	
21	ADC3	
22	RESERVED	
23	TGPIO_02	
24	VBAT	
25	VBAT	
26	GND	
27	RESERVED	
28	RESERVED	
29	VBAT	
30	VBAT	



### 34.4.2. ON\_OFF & UNCONDITIONAL SHUTDOWN, RESET BUTTONS

The 3 Buttons present on the Interface should be used to control the Power ON and UNCONDITIONAL SHUTDOWN, and RESET lines of the module.

### 34.5. Content of the kit

Please check out the contents of your interface kit; if any of the items is missing, please contact your supplier.

Description	Quantity
LE920 INTERFACE	1
MINI USB CABLE	1



## 35. HE920 Family Interface

This board allows easily interfacing the HE920 module with the EVK2 and testing their functionalities.

No settings are needed.

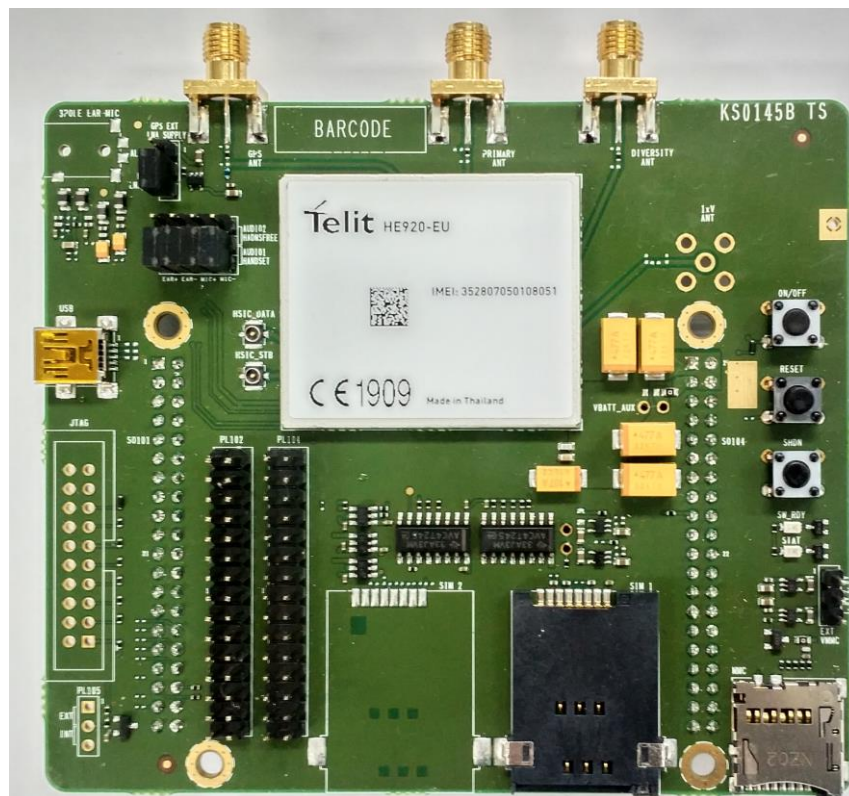

HE920 Interface Board



## 35.1. Stand-alone setup

The Jumper setting and the assembled components are ready permitting the standalone use.

## 35.2. Interface connectors

The following connectors are available:

2 female connectors (40 PTH pins each one: SO101, SO104), to connect the interface to the EVK2 mother board circuits (power supply lines, serial in/out lines, audio in/out lines);

1 USB connector (SO202) related to the LE920 USB 2.0 port.

3 RF connectors for Main, Diversity, and GPS Antenna (SO105, SO107, SO108),

1 SIM Holder (SO204)

A group of Male connectors (PL102, PL104), that provide the additional signals

The following picture is showing the connector's positions and the default settings for the Jumpers.

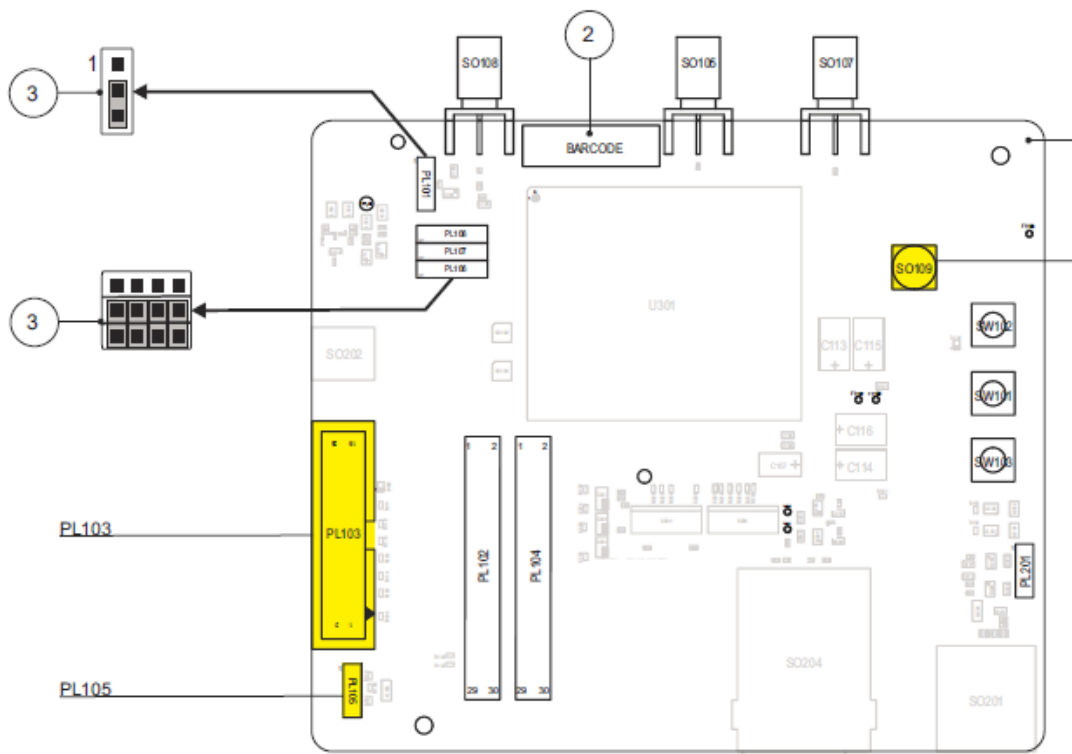







### 35.4.2. ON\_OFF & UNCONDITIONAL SHUTDOWN, RESET BUTTONS

The 3 Buttons present on the Interface should be used to control the Power ON and UNCONDITIONAL SHUTDOWN, and RESET lines of the module.

### 35.5. Content of the kit

Please check out the contents of your interface kit; if any of the items is missing, please contact your supplier.

Description	Quantity
HE920 INTERFACE	1
MINI USB CABLE	1



## 36. HE910 V2 family Interface

This board allows easily interfacing the HE910 V2 modules with the EVK2 and testing their functionalities;  
No settings are needed.

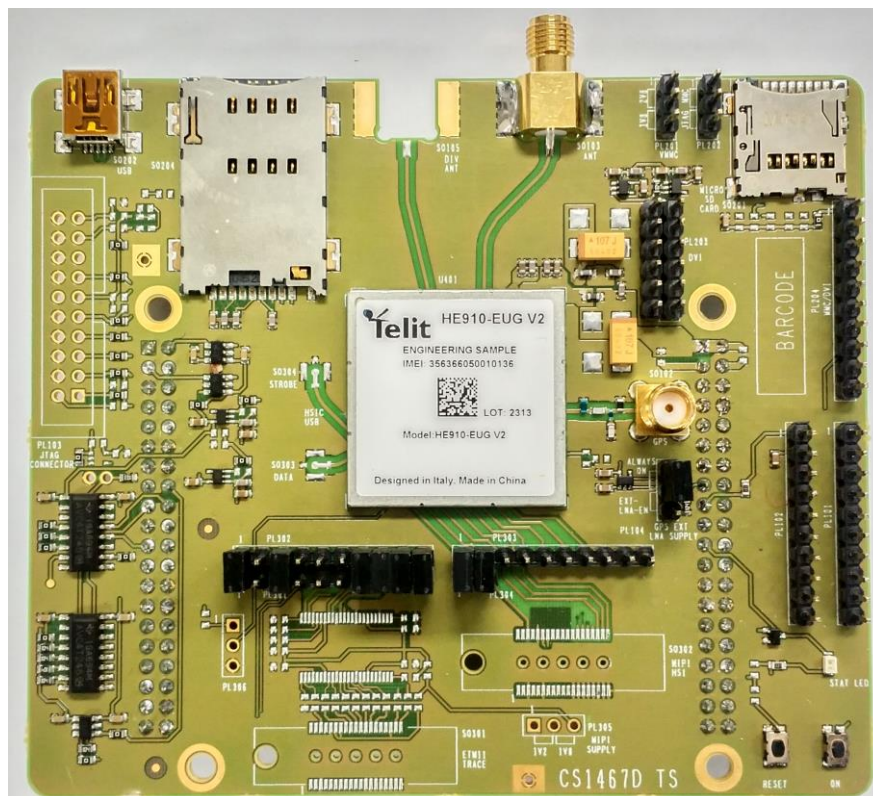

HE910 V2 Interface Board



## 36.1. Stand-alone setup

The Jumper setting and the assembled components are ready permitting the standalone use.

## 36.2. Interface connectors

The following connectors are available:

2 female connectors (40 PTH pins each one: SO101, SO104), to connect the interface to the EVK2 mother board circuits (power supply lines, serial in/out lines, audio in/out lines);

1 USB connector (SO202) related to the HE910 V2 USB 2.0 port.

2 RF connectors for GSM/UMTS Antenna (SO103) and GPS Antenna (SO102)

1 SIM Holder (SO204)

A group of Male connectors (PL301, PL302, PL303, PL304) that provide the additional signals (i.e. GPIOs) and could select the functions by Jumper setting (see the related document section/schematic for this).

The following picture is showing the connector's positions and the default settings for the Jumpers.

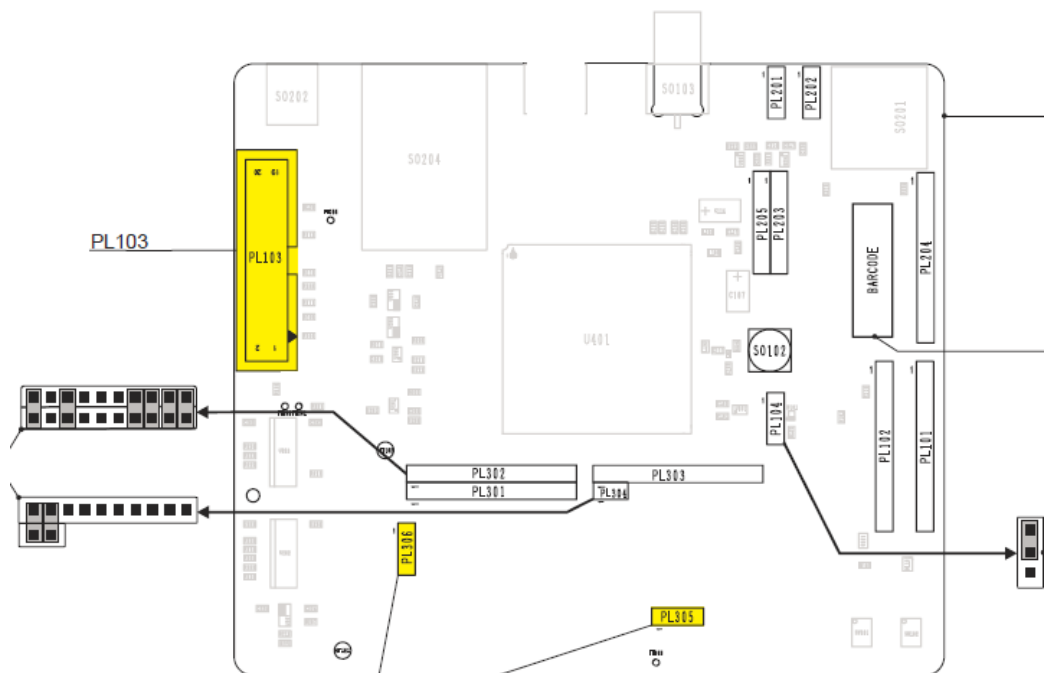





## 36.4. Expansion Connectors

### 36.4.1. PL301/PL302

The connectors are carrying the following signals:

PL301		
Pin#	Pin Name	Description
1	STAT_LED	Status Led
2	NC	
3	RESERVED	
4	NC	
5	NC	
6	NC	
7	C125/RING	
8	C107/DSR	
9	C109/DCD	
10	RESERVED	

PL302		
Pin#	Pin Name	Description
1	GPIO_01	Default function is Status Led
2	GPIO_02	
3	GPIO_03	
4	GPIO_04	
5	GPIO_06	
6	GPIO_07	
7	C125/RING	Jumper to EVK2
8	C107/DSR	Jumper to EVK2
9	C109/DCD	Jumper to EVK2
10	RESERVED	Jumper to EVK2









## 37. UE910 V2 family Interface

This board allows easily interfacing the UE910 V2 modules with the EVK2 and testing their functionalities;  
No settings are needed.

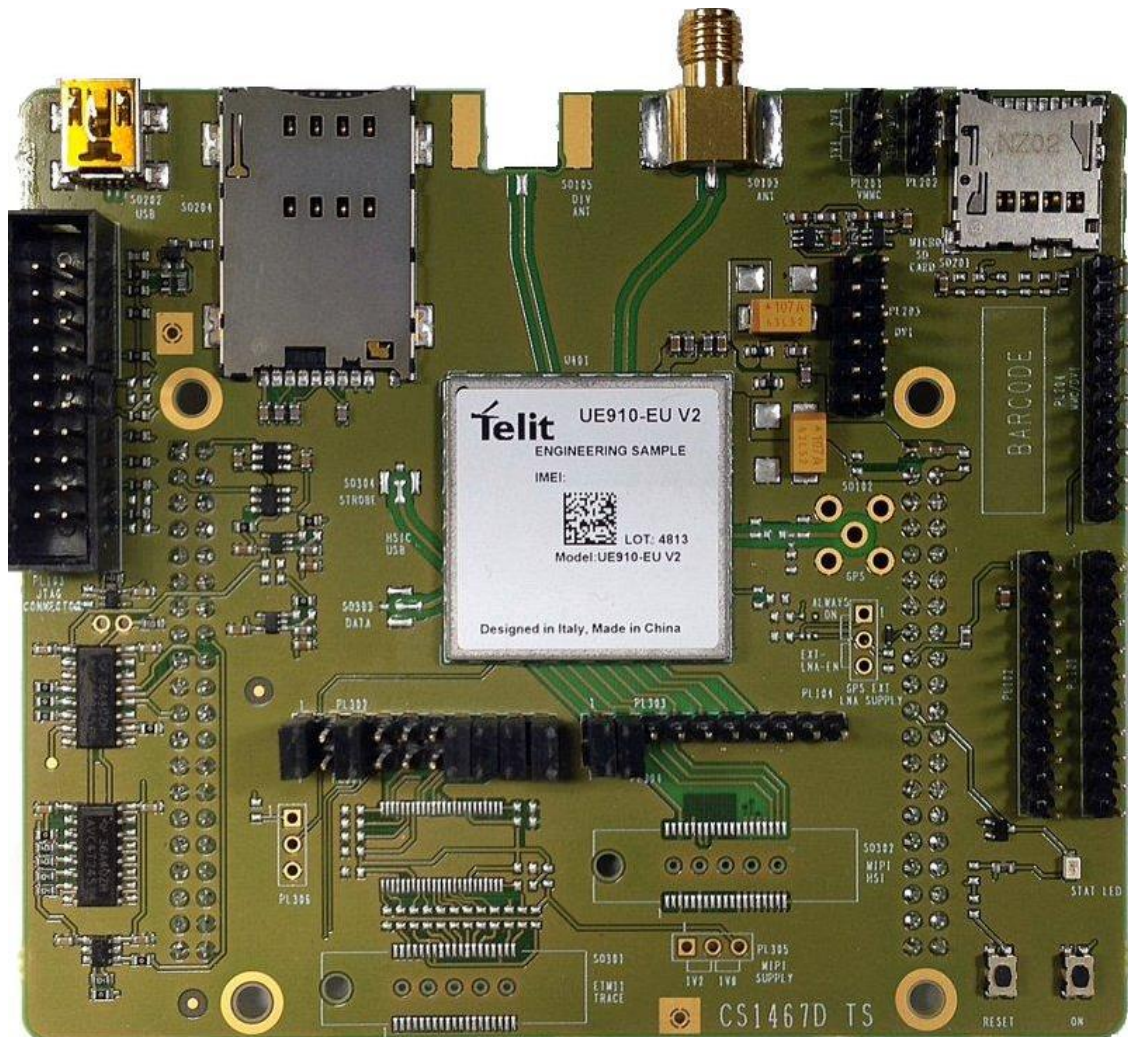

UE910 V2 Interface Board





## 37.1. Stand-alone setup

The Jumper setting and the assembled components are ready permitting the standalone use.

## 37.2. Interface connectors

The following connectors are available:

2 female connectors (40 PTH pins each one: SO101, SO104), to connect the interface to the EVK2 mother board circuits (power supply lines, serial in/out lines, audio in/out lines);

1 USB connector (SO202) related to the UE910 V2 USB 2.0 port.

2 RF connectors for GSM/UMTS Antenna (SO103) and GPS Antenna (SO102)

1 SIM Holder (SO204)

A group of Male connectors (PL301, PL302, PL303, PL304) that provide the additional signals (i.e. GPIOs) and could select the functions by Jumper setting (see the related document section/schematic for this).

The following picture is showing the connector's positions and the default settings for the Jumpers.

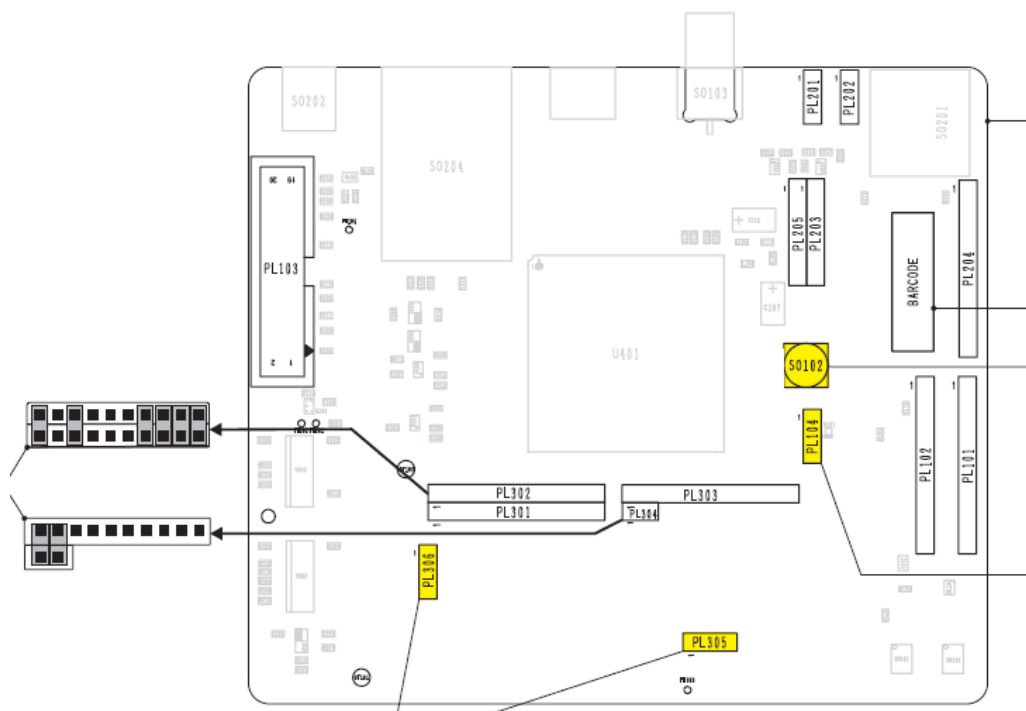



### 37.4.2. PL303/PL304/PL305

The connectors are carrying the following signals:

<b>PL303</b>		
<b>Pin#</b>	<b>Pin Name</b>	<b>Description</b>
1	TX_AUX	Auxiliary serial port (TX)
2	RX_AUX	Auxiliary serial port (RX)
3	SPI_CLK	SPI
4	SPI_MRDY	SPI
5	SPI_SRDY	SPI
6	GPIO_08	
7	GPIO_09	
8	GPIO_10	
9	RESERVED	
10	NC	

<b>PL304</b>		
<b>Pin#</b>	<b>Pin Name</b>	<b>Description</b>
1	TX_AUX	Jumper to EVK2
2	RX_AUX	Jumper to EVK2

<b>PL305</b>		
<b>Pin#</b>	<b>Pin Name</b>	<b>Description</b>
1	RESERVED	-
2	VDD_IO	Input pin for the bus supply
3	VIO_1V8	VIO supply at 1.8V



### 37.4.3. PL102

The connector is providing the following signals:

PL102		
Pin#	Pin Name	Description
1	VAUX/PWRMON	Auxiliary supply / Power On Indicator
2	VRTC	RTC Backup
3	RESERVED	
4	RESERVED	
5	RESERVED	
6	GPIO_05	GPIO
7	RESERVED	
8	RESERVED	
9	RESERVED	
10	GND	

### 37.4.4. ON\_OFF & UNCONDITIONAL SHUTDOWN BUTTONS

The 2 Buttons present on the Interface should be used to control the Power ON and UNCONDITIONAL SHUTDOWN lines of the module.

The 2 Buttons on the EVK2 could not be used with the UE910 Interface.

## 37.5. Content of the kit

Please check out the contents of your interface kit; if any of the items is missing, please contact your supplier.

Description	Quantity
UE910 V2 INTERFACE	1
MINI USB CABLE	1



## 38. CL865 Interface

This board allows easily interfacing the CL865 modules with the EVK2 and testing their functionalities.

No settings are needed.



CL865 Interface Board

### 38.1. Stand-alone setup

The Jumper setting and the assembled components are ready permitting the standalone use.





## 38.2. Interface connectors

The following connectors are available:

1 male connector (30 SMT pins each one: PL102), by which it is possible to connect external devices, user's application, Telit extension boards, measurements equipment or other tools;  
2 female connectors (40 PTH pins each one: SO101, SO104), to connect the interface to the EVK2 mother board circuits (power supply lines, serial in/out lines, audio in/out lines);

1 RF connectors for CDMA Antenna (SO103)

1 SIM Holder (SO102)

A group of Male connectors (PL101, PL105, PL106, PL107) that provide the additional signals (i.e. GPIOs) and could select the functions by Jumper setting (see the related document section/schematic for this).

The following picture is showing the connector's positions and the default settings for the Jumpers.

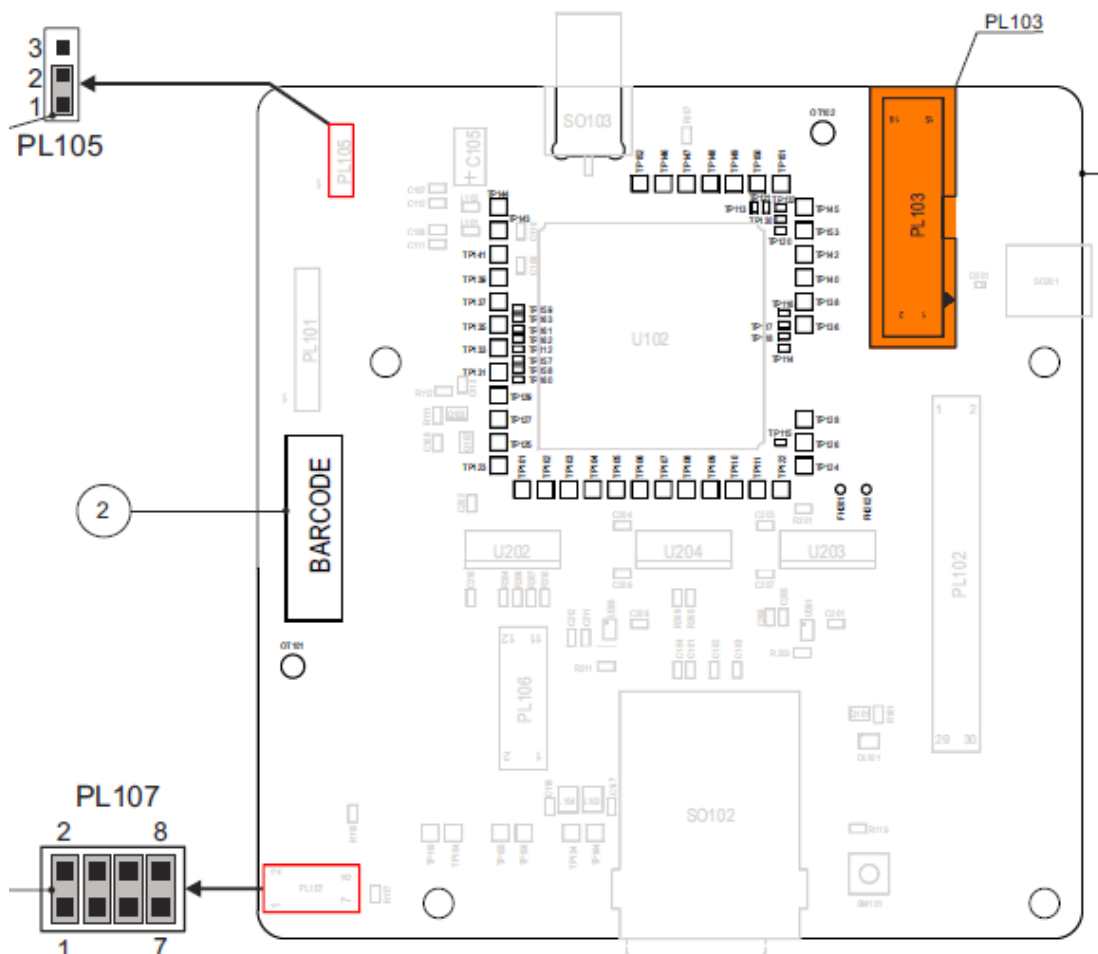

### 38.3. Antenna connectors

#### 38.3.1. CDMA Antenna connector

A CDMA compatible antenna (Refer to the product’s HW user guide) antenna must be connected to SO103.

### 38.4. Expansion Connectors

#### 38.4.1. PL101

The connector is carrying the following signals:

PL301		
Pin#	Pin Name	Description
1	VAUX	VAUX/PWRMON
2	NC	
3	SDA	GPIO07 Configurable GPIO (I2C SDA)
4	SCL	GPIO08 Configurable GPIO (I2C SCL)
5	VBATT	
6	GND	

#### 38.4.2. PL106

The connector is carrying the following signals:

PL303		
Pin#	Pin Name	Description
1	VBATT	
2	DVI_RX	Digital Audio Interface (RX)
3	NC	
4	DVI_WA0	Digital Audio Interface (WA0)
5	VAUX	VAUX/PWRMON
6	DVI_TX	Digital Audio Interface (TX)
7	BUZZER	GPIO07 Configurable GPIO
8	DVI_CLK	Digital Audio Interface (CLK)
9	STAT_LED	GPIO08 Configurable GPIO
10	GND	
11	NC	
12	NC	





## 39. GE866-QUAD Interface

This board allows easily interfacing the GE866-QUAD modules with the EVK2 and testing their functionalities.  
No settings are needed.

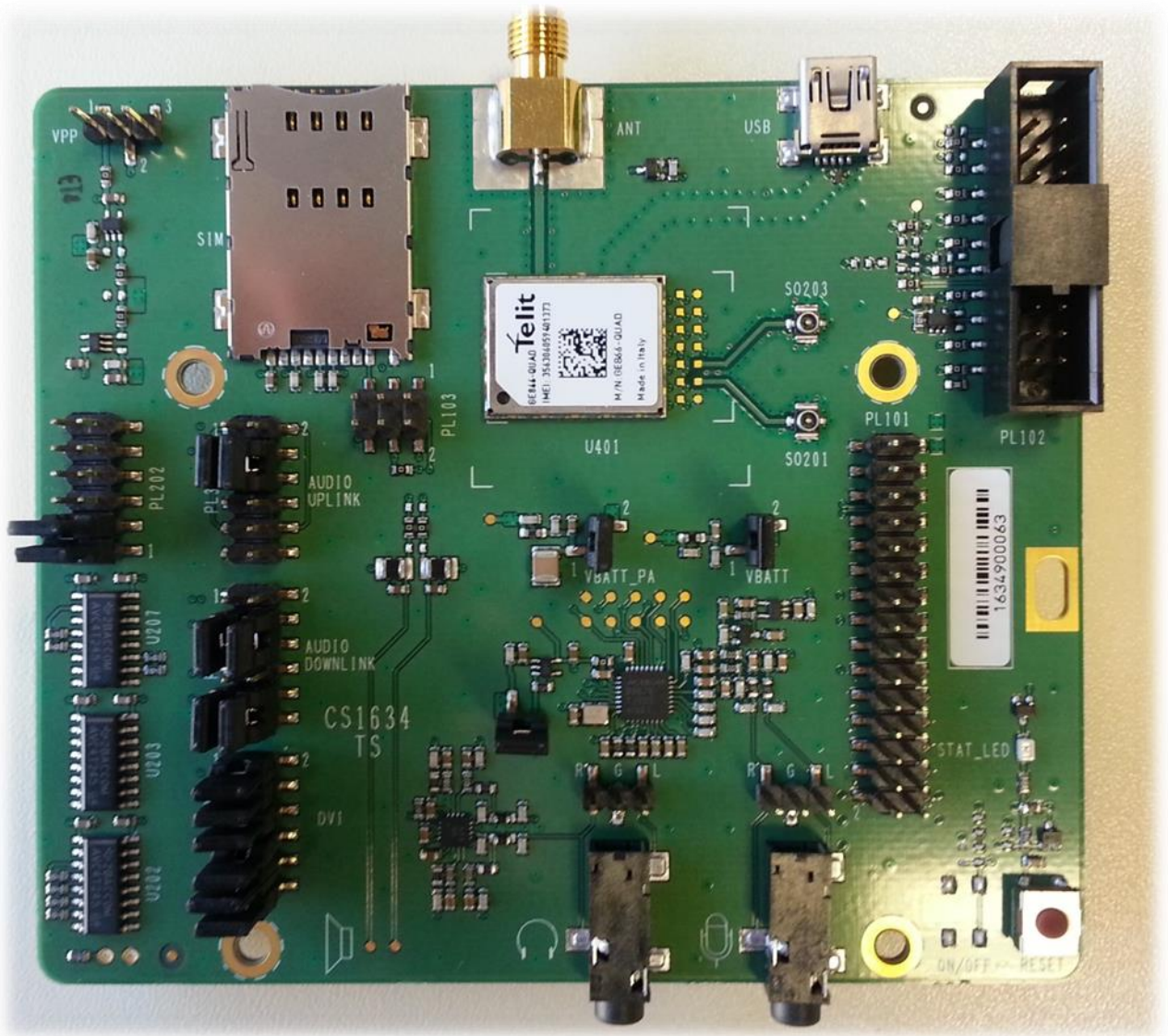

GE866-QUAD Interface Board











## 39.3. Antenna connectors

### 39.3.1. GSM Antenna connector

A GSM compatible antenna (Refer to the product's HW user guide) antenna must be connected to SO103.

## 39.4. Expansion Connectors

### 39.4.1. PL101

The connector carries the following signals:

PL101		
Pin#	Pin Name	Description
1	GPIO_05/RFTXMON	RF transmission monitor
2	GPIO_06/ALARM/BUZZER	Alarm or buzzer output
3	NC	
4	NC	
5	GPIO_07/STAT_LED	Status pin
6	GPIO_01/DVI_WA0	Digital audio interface WA0
7	GPIO_04/DVI_CLK	Digital audio interface Clock
8	GPIO_03/DVI_TX	Digital audio interface TX
9	NC	
10	NC	
11	NC	
12	GPIO_06/ALARM/BUZZER	Alarm or buzzer output
13	NC	
14	NC	
15	NC	
16	V_AUX/PWRMON	Pull-up reference or ON monitor
17	DAC_OUT	10 bit DAC output, 1.8V max
18	VRTC	Real Time Clock supply
19	ADC_IN	11 bit ADC converter, 0-1.2
20	NC	
21	NC	
22	NC	
23	GPIO_02/DVI_RX	Digital audio interface RX
24	NC	
25	RESERVED	
26	NC	
27	NC	
28	NC	
29	VBATT_IF	3.8V supply
30	GND	



## 39.5. Audio configuration

### 39.5.1. PL301

This jumper is mandatory if you want to use the digital audio interface. Leave it open if you want to use only analog audio interface.



### 39.5.2. PL302

This connector allows configuring GPIOs from 1 to 6 as DIGITAL AUDIO INTERFACE. This configuration is achieved by placing the jumpers as indicated below:

PL302		
Jumpers on pins#	Signal on GE866	Description
1-2	GPIO 02/DVI RX	DVI RX
3-4	GPIO 01/DVI WA0	DVI WA0
5-6	GPIO 03/DVI TX	DVI TX
7-8	GPIO 04/DVI CLK	DVI CLK
9-10	GPIO 06/ALARM/BUZZER	I2C SDA (GPIO used as I2C SDA with AT#I2CWR only to configure external codec)
11-12	GPIO 05/RFTXMON	I2C SCL (GPIO used as I2C SCL with AT#I2CWR only to configure external codec)

If ANALOG INTERFACE is used, you need to leave all the jumpers open and you can use these signals as normal GPIOs.

### 39.5.3. PL304 & PL305

These connectors allows configuring the path of audio data analog or digital. PL304 is for Audio Downlink (Speaker or Headphones) and PL305 for Audio Uplink (Microphone)



PL304		
Jumpers on pins#	Signal Name	Description
1-3	Left Out +	Analog audio out
2-4	Right Out +	
7-9	Left Out -	
8-10	Right Out -	
3-5	Left Out +	Digital audio out
4-6	Right Out +	
9-11	Left Out -	
10-12	Right Out -	

PL305		
Jumpers on pins#	Signal Name	Description
1-3	Audio In -	From onboard Jack To Module (analog)
2-4	Audio In +	
3-5	Audio In -	From onboard Jack To Codec (digital)
4-6	Audio In +	
5-7	Audio In -	From EVK2 Jack to Codec (digital)
6-8	Audio In +	
7-9	Audio In -	From EVK2 Jack to Module (analog)
8-10	Audio In +	

You can also connect an external speaker by using the two Test Points, as shown in the figure below:

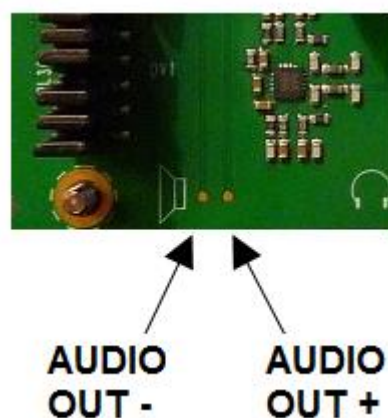

### 39.5.4. PL306 and PL307

These connectors provide an additional input/output for interfacing an earphone and a microphone to the GE866-QUAD.

Pin 1 is, for both connectors, the one closest to the upper side of the board (i.e. the side where the GSM antenna connector is mounted).

Pin#	PL306	PL307
1(R)	Microphone right	Earphone right
2(G)	GND	GND
3(L)	Microphone left	Earphone left

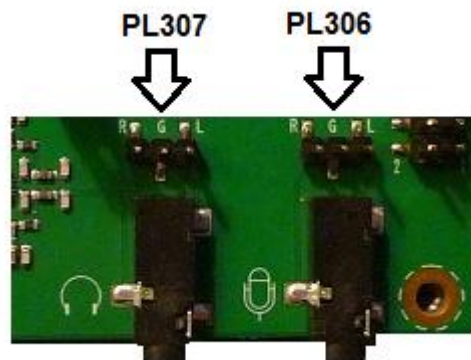



## 39.6. Other interface connectors

### 39.6.1. PL104 & PL105 (POWER)

These two jumpers allows connecting and disconnecting VBATT\_PA and VBATT to perform current measures.

### 39.6.2. PL103 (SIMIN)

This 6 pins connector allows you to configure a GPIO as SIMIN signal following the table below:

PL103		
Jumpers on pins#	Signal Name	Description
1-2	SIMIN	GPIO_05/RFTXMON
3-4		GPIO_06/ALARM/BUZZER
5-6		GPIO_07/STAT_LED

The default configuration does not foresee any jumper

### 39.6.3. PL202 (AUX UART)

This jumper activates the auxiliary serial port. In the default configuration, jumpers are placed on pins 1-2 and 3-4. Other combinations are reserved for future use.

## 39.7. Content of the kit

Please check out the contents of your interface kit; if any of the items is missing, please contact your supplier.

Description	Quantity
GE866-QUAD Interface	1
Jumpers	17



## 40. UE866 Interface

This board allows easily interfacing the UE866 modules with the EVK2 and testing their functionalities.

No settings are needed.

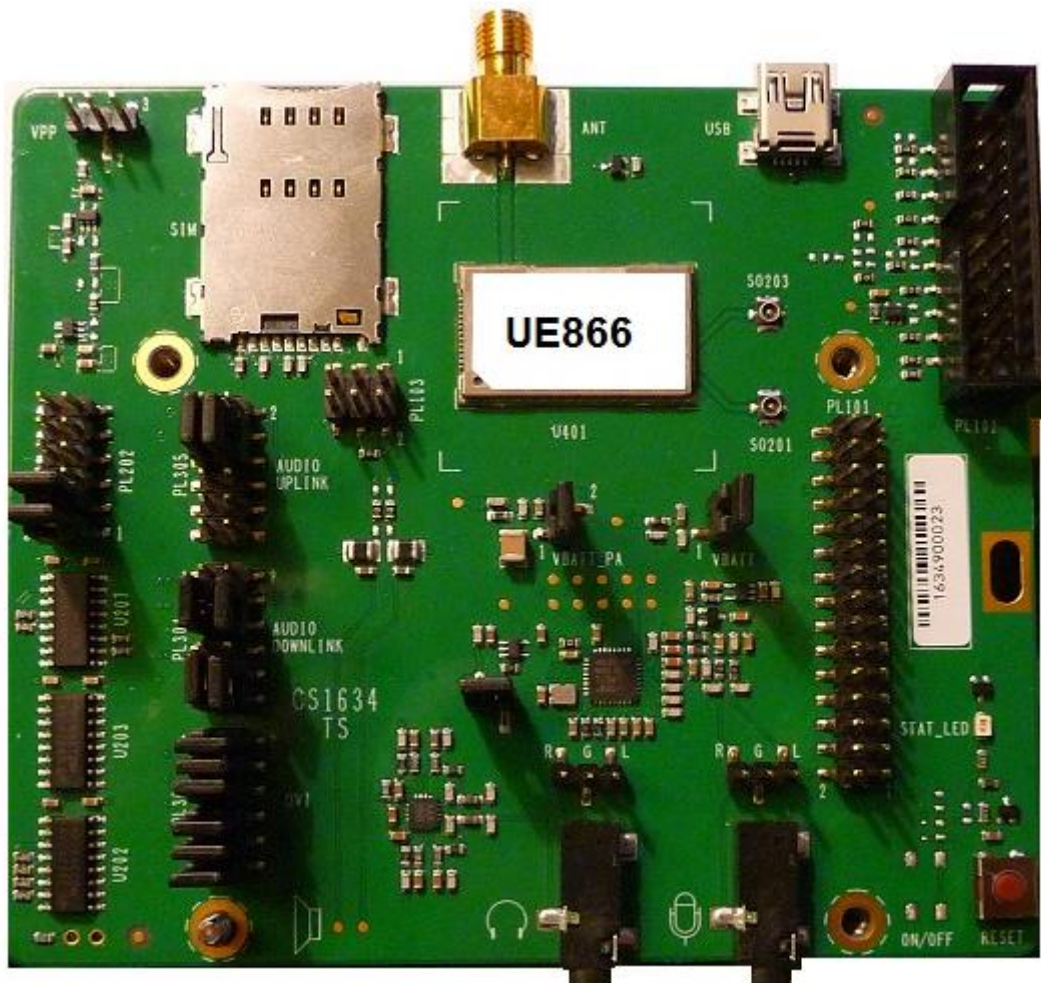

UE866 Interface Board



## 40.1. Stand-alone setup

The jumper factory default configuration is set-up to use the interface in stand-alone (without the EVK2).

## 40.2. Interface connectors

The following connectors are available:

- 2 female connectors on bottom side (40 SMT pins each one: SO101, SO104), to connect the interface to the EVK2 mother board.
- 1 male connector (30 SMT pins 2.54mm pitch) PL101 to connect external devices, user's application, Telit extension boards, measurements equipment or other tools.
- 1 RF connector for GSM Antenna (SO103)
- A group of Male connectors (PL103, PL201, PL202, PL302, PL304, PL305) providing additional signals and different configurations by using jumper settings (See the related document section/schematics for this)
- 2 jumpers (PL104, PL105) marked on silkscreen as VBATT and VBATT\_PA allowing current measures
- 1 jumper (PL301) to enable the audio codec
- 2 Male 3 pins connectors (PL306, PL307) allowing to connect additional microphones and headphones respectively.
- 2 stereo audio jacks 3.5mm (SO301, SO302) to connect microphone and headphones
- 1 USB Device connector (SO202)
- 1 RESET Button



The following picture shows connectors placement and default jumper settings. Details in the following paragraphs.

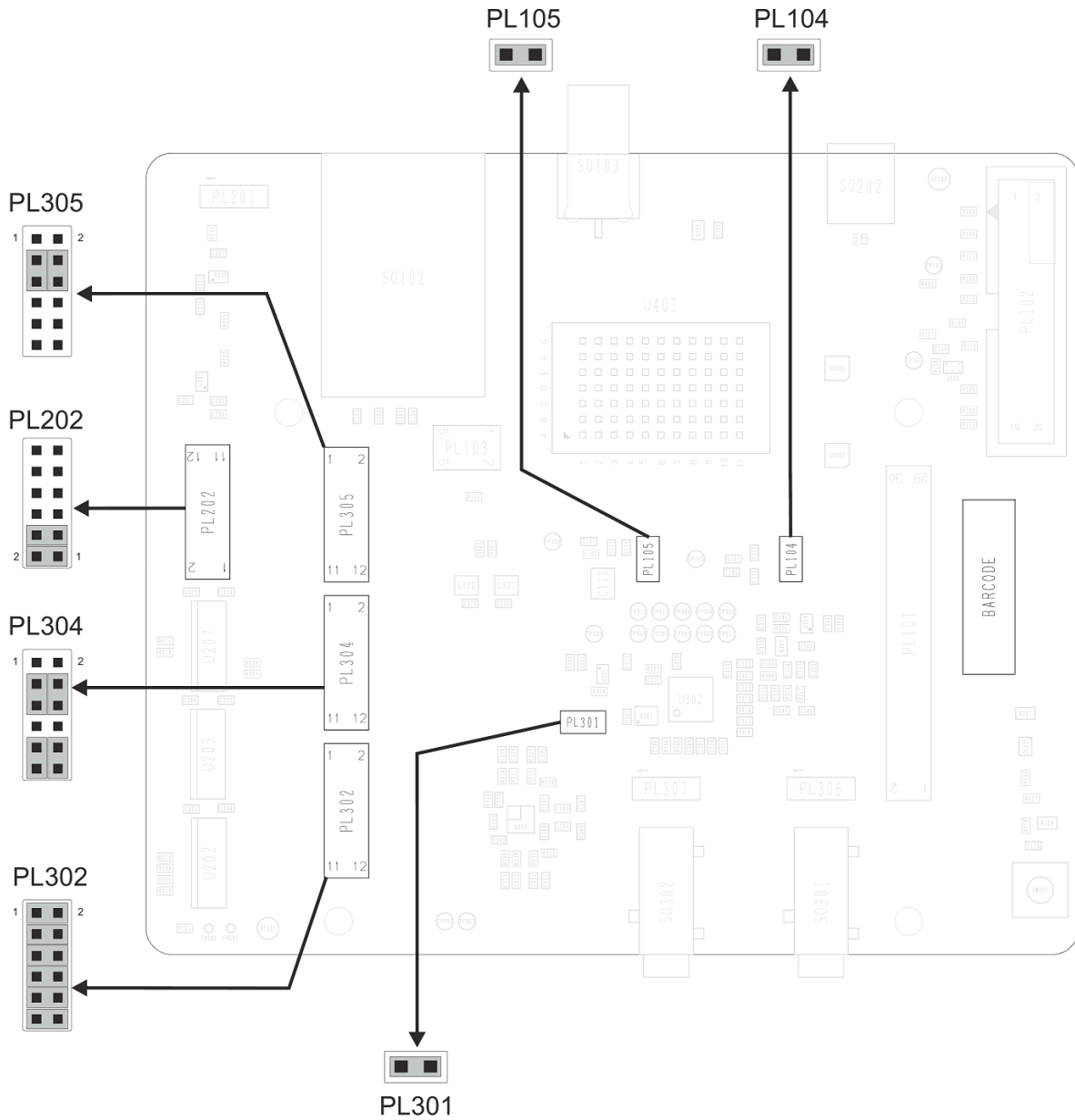



## 40.3. Antenna connectors

### 40.3.1. Main Antenna connector

A 3G compatible antenna (Refer to the product’s HW user guide) antenna must be connected to SO103.

## 40.4. Expansion Connectors

### 40.4.1. PL101

The connector carries the following signals:

PL101		
Pin#	Pin Name	Description
1	GPIO_05	
2	GPIO_06/ALARM	Alarm or buzzer output
3	NC	
4	NC	
5	GPIO_07/STAT_LED	Status pin
6	GPIO_01/DVI_WA0	Digital audio interface WA0
7	GPIO_04/DVI_CLK	Digital audio interface Clock
8	GPIO_03/DVI_TX	Digital audio interface TX
9	NC	
10	NC	
11	NC	
12	GPIO_06/ALARM	Alarm
13	NC	
14	NC	
15	NC	
16	V_AUX/PWRMON	Pull-up reference or ON monitor
17	DAC_OUT	10 bit DAC output, 1.8V max
18	VRTC	Real Time Clock backup supply
19	ADC_IN	11 bit ADC converter, 0-1.2
20	NC	
21	NC	
22	NC	
23	GPIO_02/DVI_RX	Digital audio interface RX
24	NC	
25	RESERVED	
26	NC	
27	NC	
28	NC	
29	VBATT_IF	3.8V supply
30	GND	





## 40.5. Audio configuration

### 40.5.1. PL301

This jumper is mandatory if you want to use the digital audio interface:



### 40.5.2. PL302

This connector allows configuring GPIOs from 1 to 6 as DIGITAL AUDIO INTERFACE. This configuration is achieved by placing the jumpers as indicated below:

PL302		
Jumpers on pins#	Signal on UE866	Description
1-2	GPIO 02/DVI RX	DVI RX
3-4	GPIO 01/DVI WA0	DVI WA0
5-6	GPIO 03/DVI TX	DVI TX
7-8	GPIO 04/DVI CLK	DVI CLK
9-10	GPIO 06/ALARM	I2C SDA (GPIO used as I2C SDA with AT#I2CWR only to configure external codec)
11-12	GPIO 05	I2C SCL (GPIO used as I2C SCL with AT#I2CWR only to configure external codec)





#### 40.5.4. PL306 and PL307

These connectors provide an additional input/output for interfacing an earphone and a microphone to the codec.

Pin#	PL306	PL307
1(R)	Microphone right	Earphone right
2(G)	GND	GND
3(L)	Microphone left	Earphone left

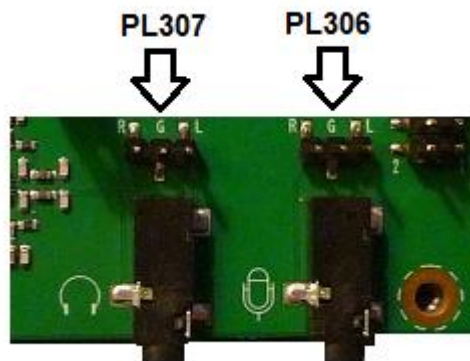

## 40.6. Other interface connectors

### 40.6.1. PL104 & PL105 (POWER)

These two jumpers allows connecting and disconnecting VBATT\_PA and VBATT.

### 40.6.2. PL103 (SIMIN)

This 6 pins connector allows you to configure a GPIO as SIMIN signal following the table below:

PL103		
Jumpers on pins#	Signal Name	Description
1-2	SIMIN	GPIO_05
3-4		GPIO_06/ALARM
5-6		GPIO_07/STAT_LED

The default configuration does not foresee any jumper

### 40.6.3. PL202 (AUX UART)

This jumper activates the auxiliary serial port. In the default configuration, jumpers are placed on pins 1-2 and 3-4. Other combinations are reserved for future use.

## 40.7. Content of the kit

Please check out the contents of your interface kit; if any of the items is missing, please contact your supplier.

Description	Quantity
UE866 Interface	1
Jumpers	17





## 41. UL865 Interface

This board allows easily interfacing the UL865 modules with the EVK2 and testing their functionalities.

No settings are needed.

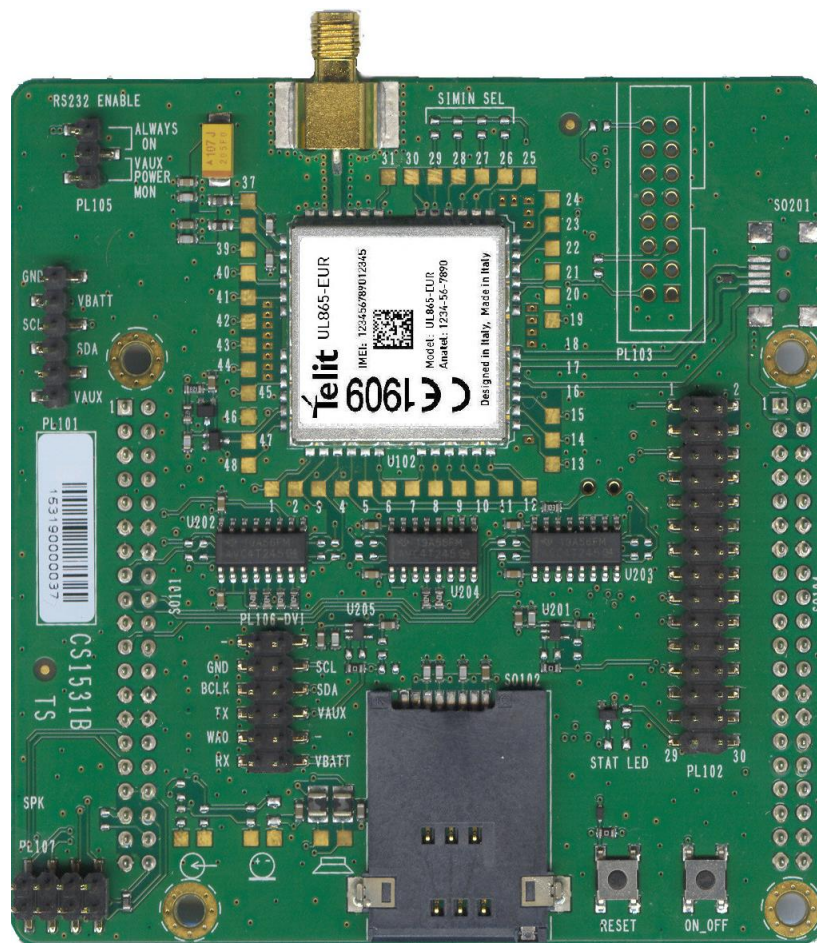

UL865 Interface Board

### 41.1. Stand-alone setup

The Jumper setting and the assembled components are ready permitting the standalone use.





## 41.2. Interface connectors

The following connectors are available:

1 male connector (30 SMT pins each one: PL102), by which it is possible to connect external devices, user's application, Telit extension boards, measurements equipment or other tools;  
2 female connectors (40 PTH pins each one: SO101, SO104), to connect the interface to the EVK2 mother board circuits (power supply lines, serial in/out lines, audio in/out lines);

1 RF connectors for GSM Antenna (SO103)

1 SIM Holder (SO102)

A group of Male connectors (PL101, PL105, PL106) that provide the additional signals (i.e. GPIOs) and could select the functions by Jumper setting (see the related document section/schematic for this).

The following picture is showing the connector's positions and the default settings for the Jumpers.

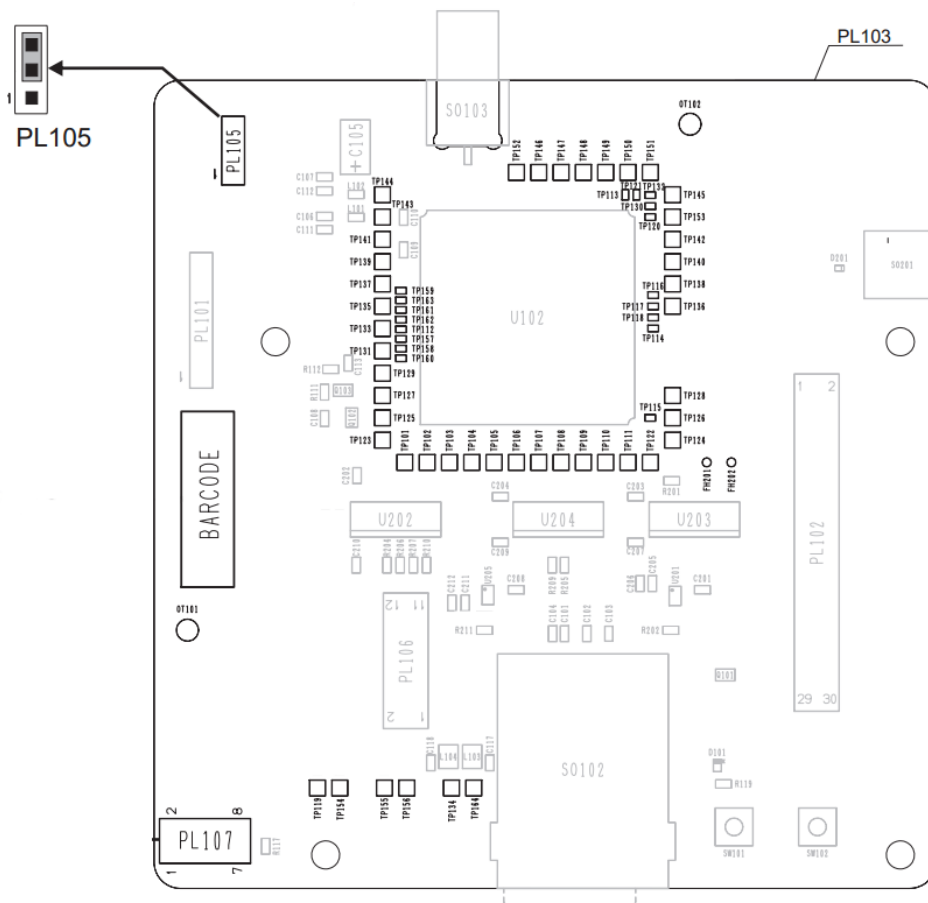



## 41.5. Content of the kit

Please check out the contents of your interface kit; if any of the items is missing, please contact your supplier.

Description	Quantity
UL865 INTERFACE	1



## 42. LE910 Interface

This board allows easily interfacing the LE910 modules with the EVK2 and testing their functionalities;  
No settings are needed.

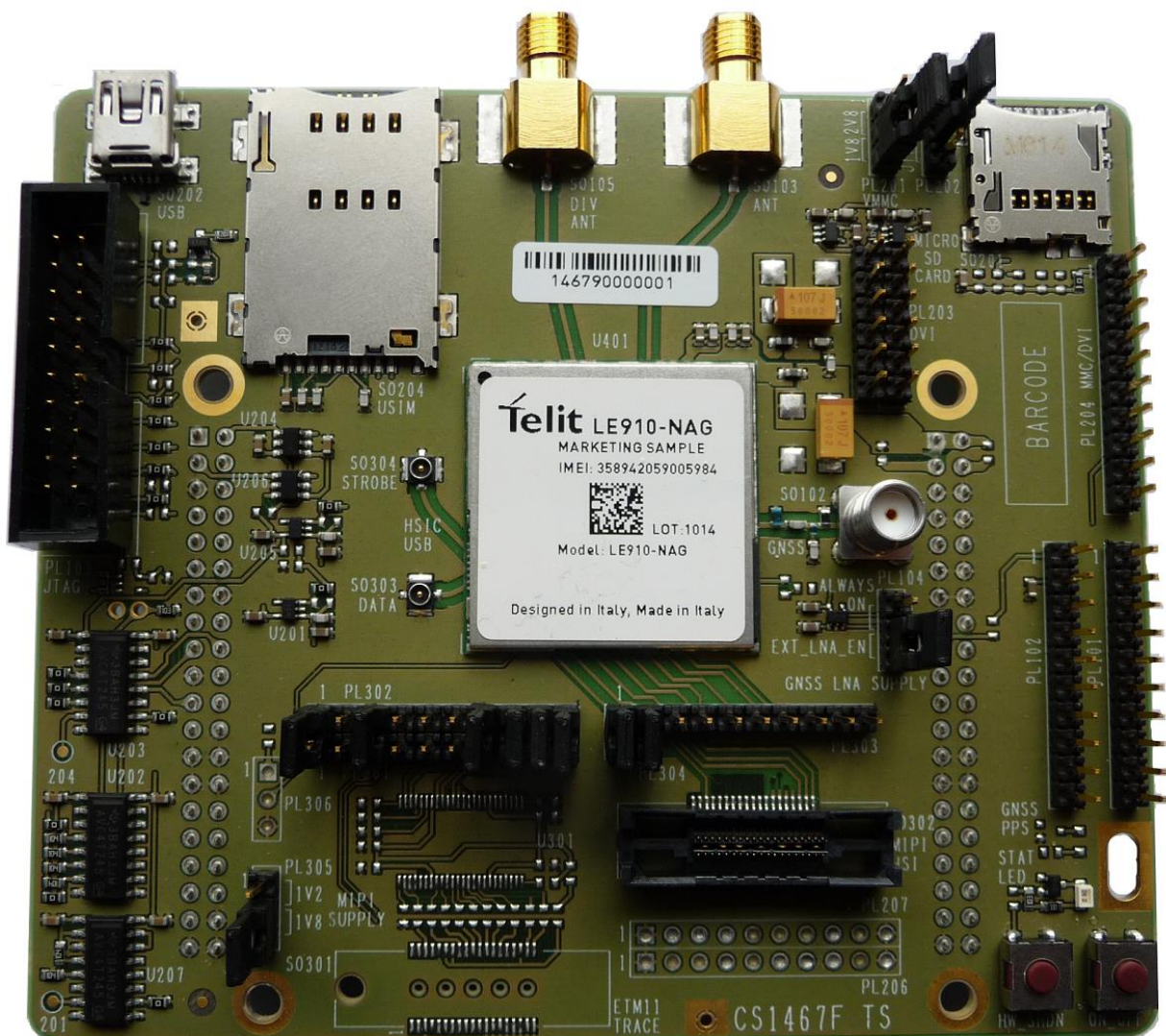

LE910 Interface Board





## 42.1. Stand-alone setup

The Jumper setting and the assembled components are ready permitting the standalone use.

## 42.2. Interface connectors

The following connectors are available:

2 female connectors (40 PTH pins each one: SO101, SO104), to connect the interface to the EVK2 mother board circuits (power supply lines, serial in/out lines, audio in/out lines);

1 USB connector (SO202) related to the LE910 USB 2.0 port.

3 RF connectors for Main Antenna (SO103) , Diversity Antenna (SO105) and GNSS antenna (SO102)

1 SIM Holder (SO204)

A group of Male connectors (PL301, PL302, PL303, PL304, PL305, PL102, PL104, PL203) that provide the additional signals (i.e. GPIOs) and could select the functions by Jumper setting (see the related document section/schematic for this).

The following picture is showing the connector's positions and the default settings for the Jumpers.

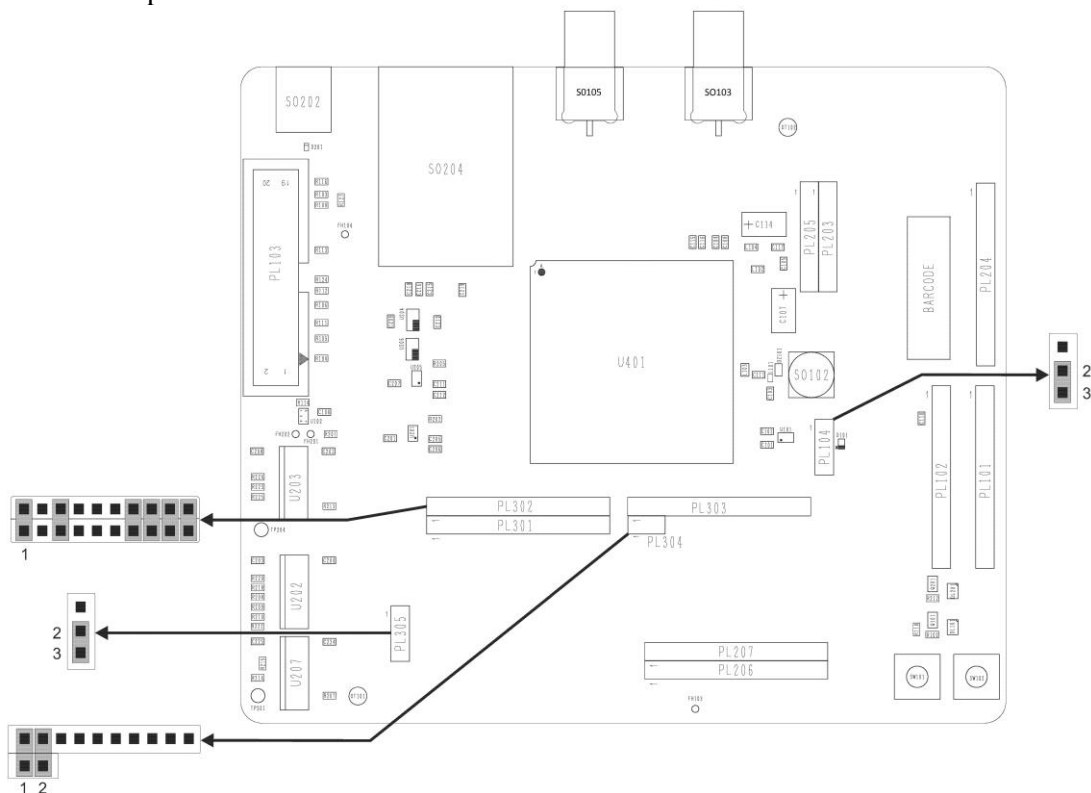



## 42.3. Antenna connectors

### 42.3.1. GSM/GPRS Antenna connector

An LTE/WCDMA/GSM compatible antenna (Refer to the product's HW user guide) antenna must be connected to SO103.

### 42.3.2. GNSS antenna connector

A GNSS antenna could be connected to SO102. Please refer to the product's HW user guide for the proper type.

The GNSS Antenna (if an active type) could be supplied with a dedicated LDO (3V DC) that could be set in the following way using the Jumpers on PL104.

LDO Enabled by the LE910 Module.

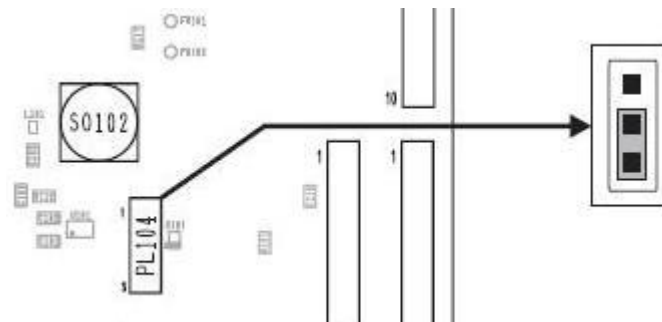

LDO Always Enabled

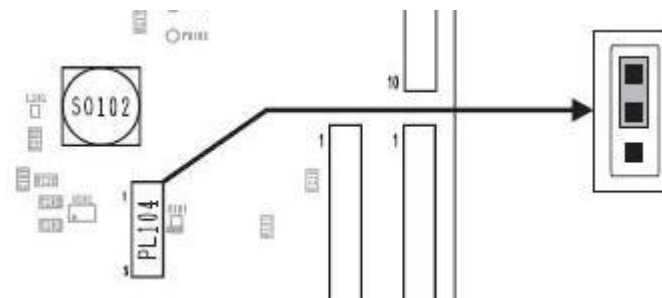

## 42.4. Expansion Connectors

### 42.4.1. PL301/PL302

The connectors are carrying the following signals:

PL301		
Pin#	Pin Name	Description
1	STAT_LED	Status Led
2	NC	
3	RESERVED	
4	NC	
5	NC	
6	NC	
7	C125/RING	
8	C107/DSR	
9	C109/DCD	
10	RESERVED	

PL302		
Pin#	Pin Name	Description
1	GPIO_01	Jumper to EVK2 Default function is Status Led
2	GPIO_02	
3	GPIO_03	
4	GPIO_04	
5	GPIO_06	
6	GPIO_07	
7	C125/RING	Jumper to EVK2
8	C107/DSR	Jumper to EVK2
9	C109/DCD	Jumper to EVK2
10	RESERVED	



#### 42.4.2. PL303/PL304

The connectors are carrying the following signals:

PL303		
Pin#	Pin Name	Description
1	TX_AUX	Auxiliary serial port (TX)
2	RX_AUX	Auxiliary serial port (RX)
3	RESERVED	
4	RESERVED	
5	RESERVED	
6	GPIO_08	
7	GPIO_09	
8	GPIO_10	
9	RESERVED	
10	NC	

PL304		
Pin#	Pin Name	Description
1	TX_AUX	Jumper to EVK2
2	RX_AUX	Jumper to EVK2

#### 42.4.3. PL102

The connector is providing the following signals:

PL102		
Pin#	Pin Name	Description
1	VAUX/PWRMON	Auxiliary supply / Power On Indicator
2	VRTC	RTC Backup
3	RESERVED	
4	RESERVED	
5	RESERVED	
6	GPIO_05	GPIO
7	RESERVED	
8	RESERVED	
9	RESERVED	
10	GND	



#### 42.4.4. ON\_OFF & UNCONDITIONAL SHUTDOWN BUTTONS

The 2 Buttons present on the Interface should be used to control the Power ON and UNCONDITIONAL SHUTDOWN lines of the module.

The 2 Buttons on the EVK2 could not be used with the LE910 Interface.  
For the GNSS capabilities refer to LE910 Hardware User Guide.

#### 42.5. Content of the kit

Please check out the contents of your interface kit; if any of the items is missing, please contact your supplier.

Description	Quantity
LE910 INTERFACE	1
MINI USB CABLE	1







## 43.1. GPIO location

### 43.1.1. GM862 Interface

(Refer to schematic diagram 30276SE11150B)

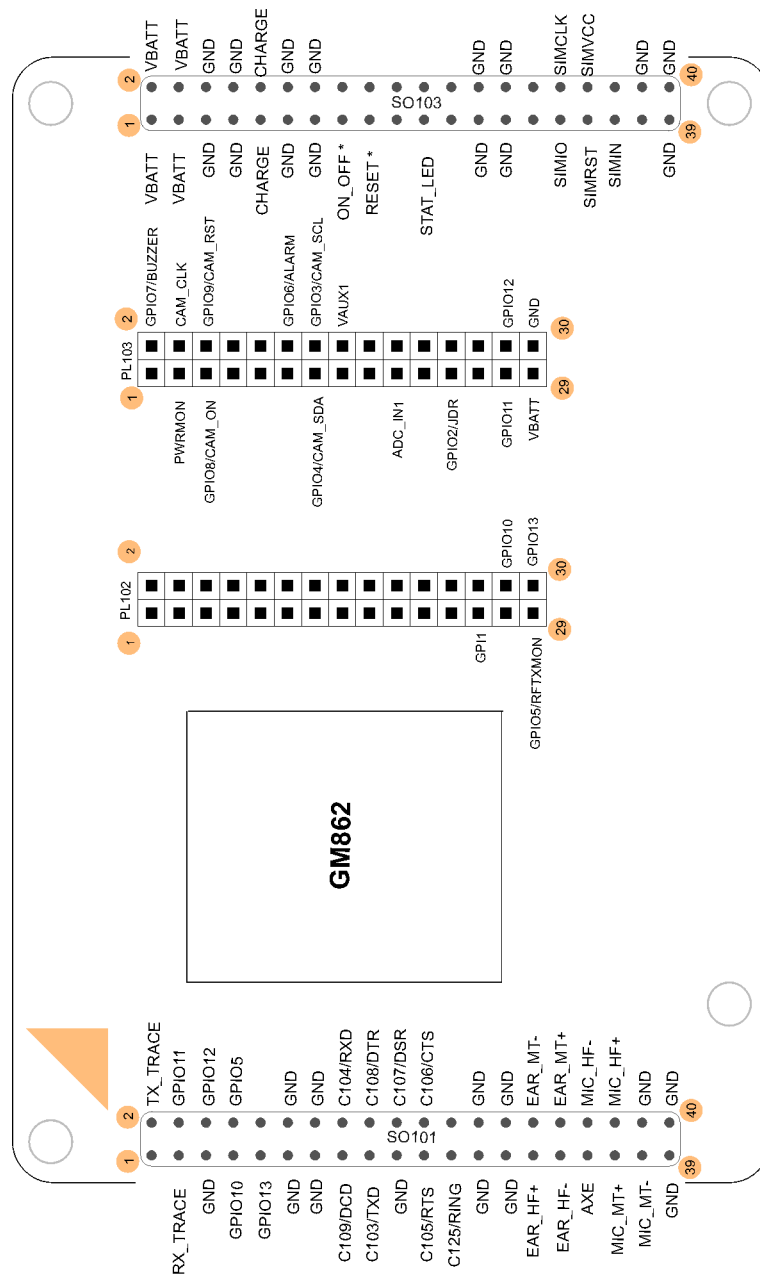

Position of GPIO ports on GM862 interface



**Note on GM862-GPS version**

If you use this interface in conjunction with GM862-GPS version *be careful* that the following two pins of SO101 connector assume different functions, and precisely:

Pin 2 = TX\_GPS

Pin 3 = RX\_GPS



### 43.1.2. GE863-GPS Interface

(Refer to schematic diagram 30276SE11151A)

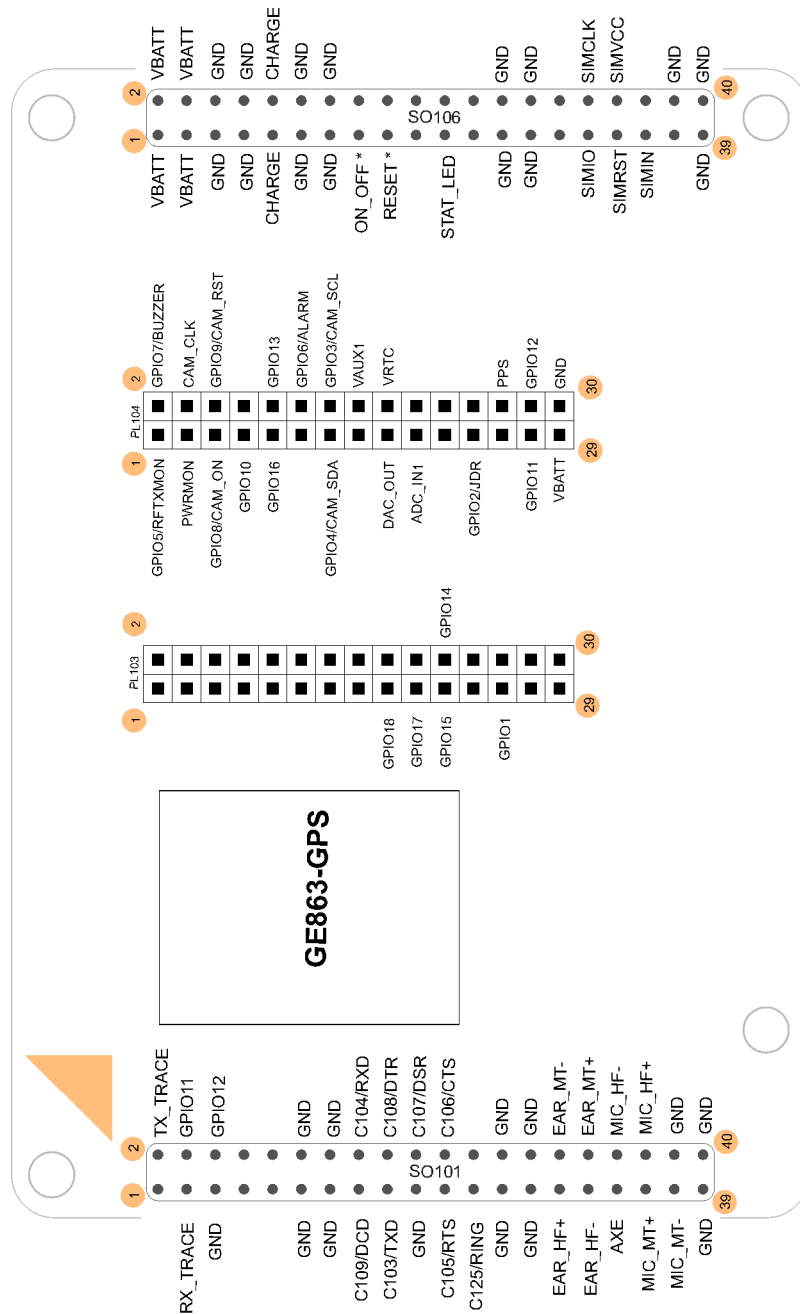

Position of GPIO ports on GE863-GPS interface



**Note on p/n 3990250684 and p/n 3990250685 GE863**  
(Refer to schematic diagrams *30276SE11151A-C*, *30276SE11151A-D*)

If you use these interfaces the following two pins of PL104 connector assume different functions, and precisely:

Pin 20 = ADC\_IN2  
Pin 21 = ADC\_IN3  
Pin 26 = N.C



### 43.1.3. GE863 Interfaces (p/n 3990250684 -3990250685-3990250703)

Refer to schematic diagrams 3\0276SE11151A-C; 30276SE11151A-D; 30276SE11151A-G

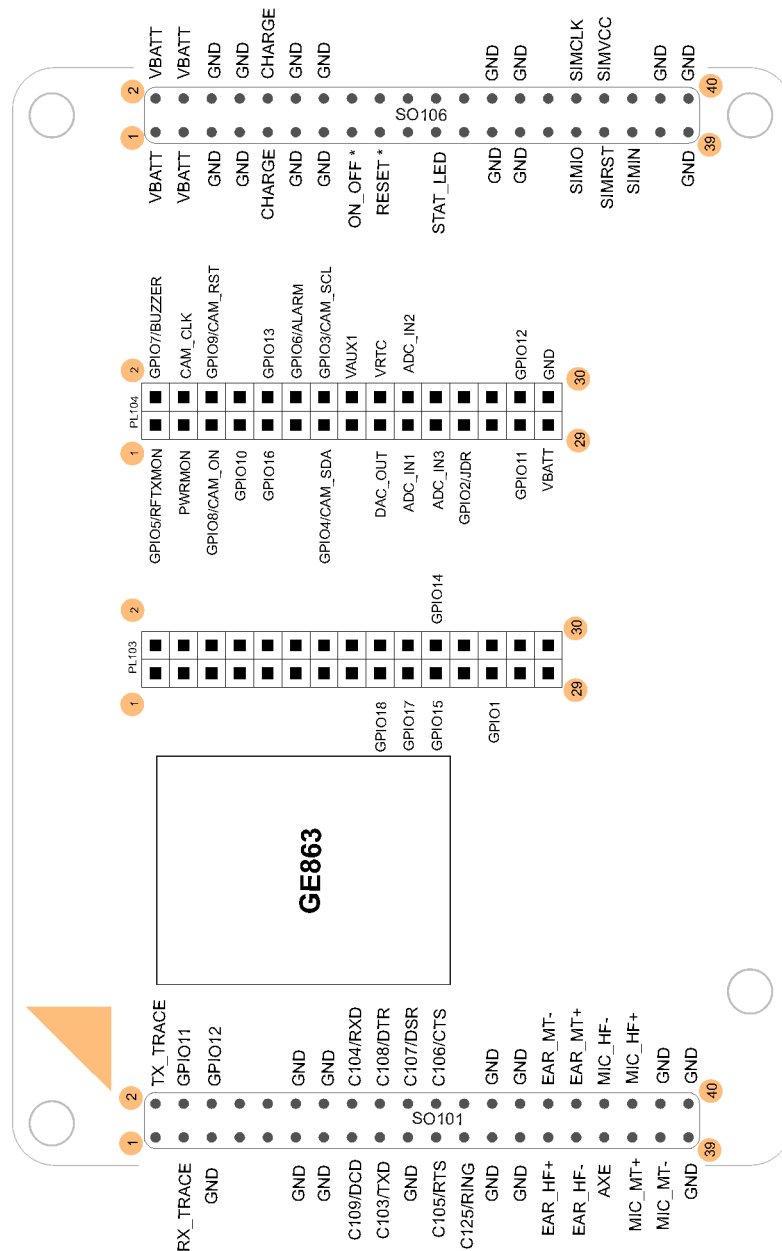

Position of GPIO ports on GE863 interfaces





### 43.1.4. GE864 Interface (p/n 3990250672)

(Refer to schematic diagram 30276SE1152B)

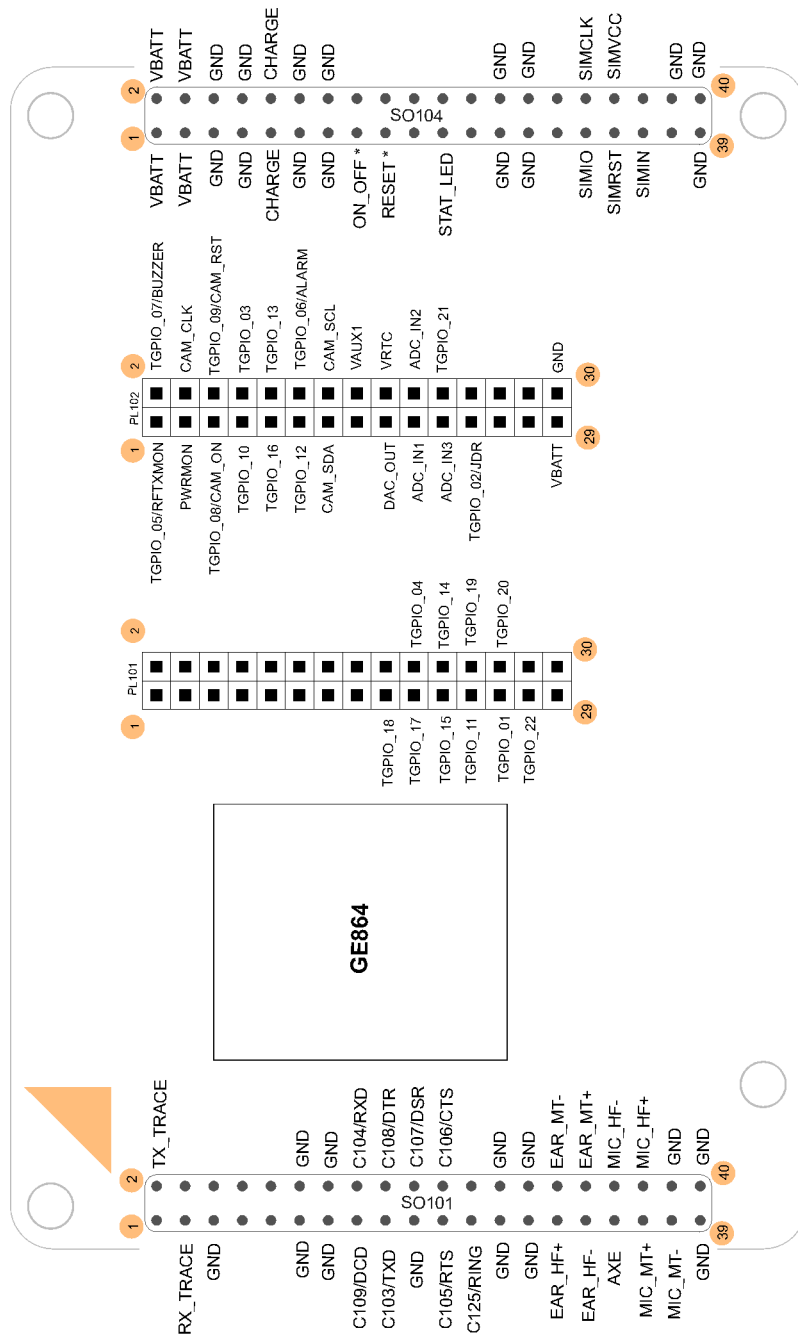

Position of GPIO ports on GE864 interface



### 43.1.5. GE864-GPS Interface (p/n 3990250822)

(Refer to schematic diagram 30373SE11439b)

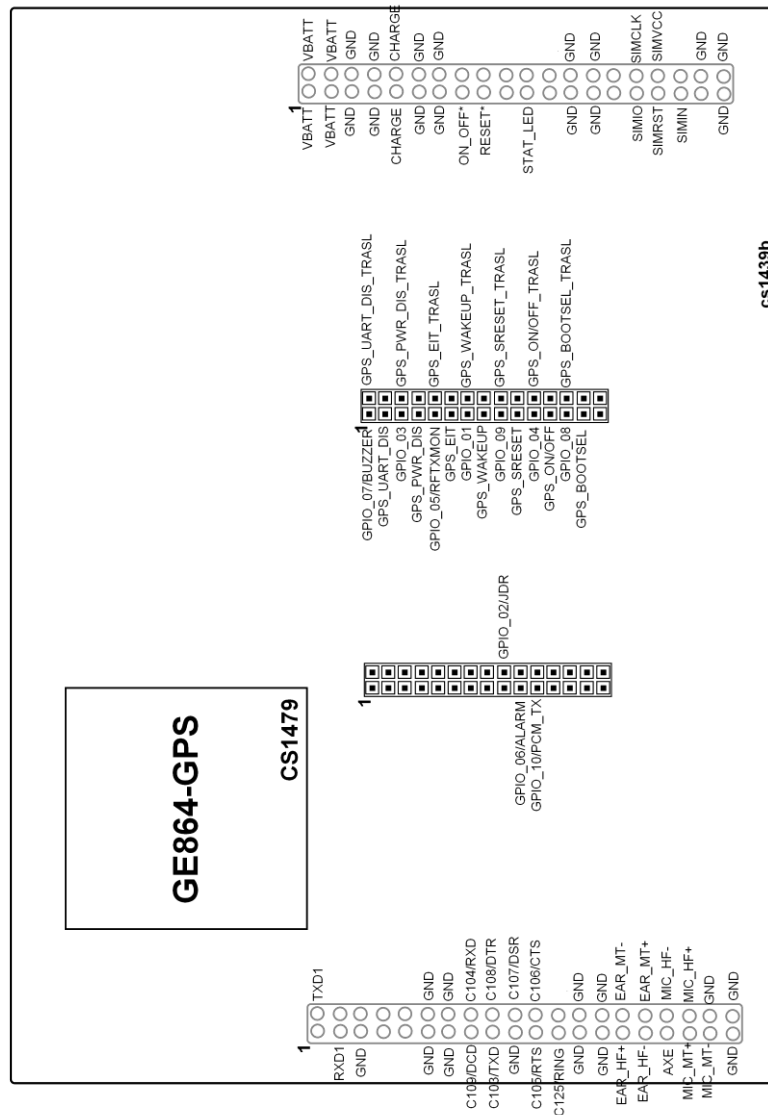

Position of GPIO ports on GE864-GPS interface



### 43.1.6. GE865/SE867-AGPS Interface (p/n 3990250814)

(Refer to schematic diagram 30311SE11433)

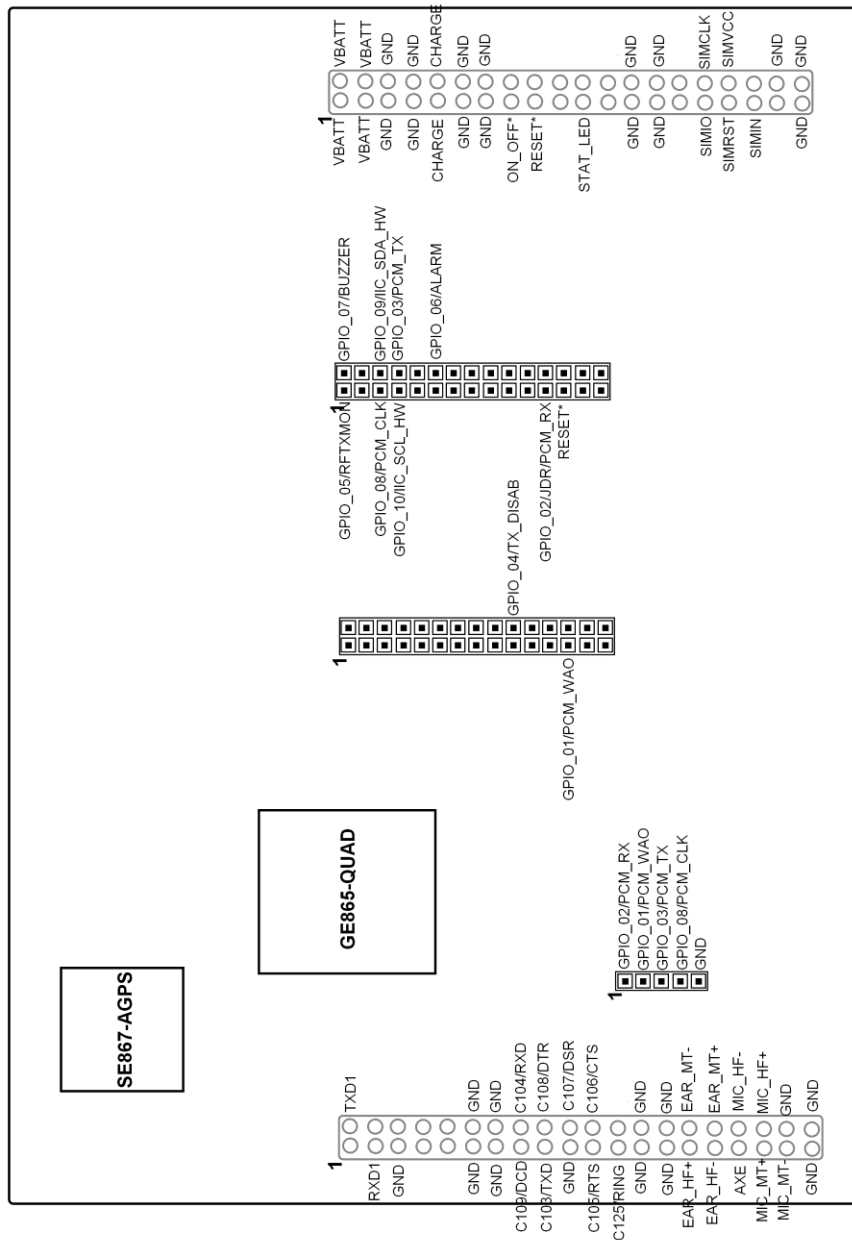

Position of GPIO ports on GE865/SE867-AGPS interface



### 43.1.7. GC864 Interface

(Refer to schematic diagram 30276SE111203B)

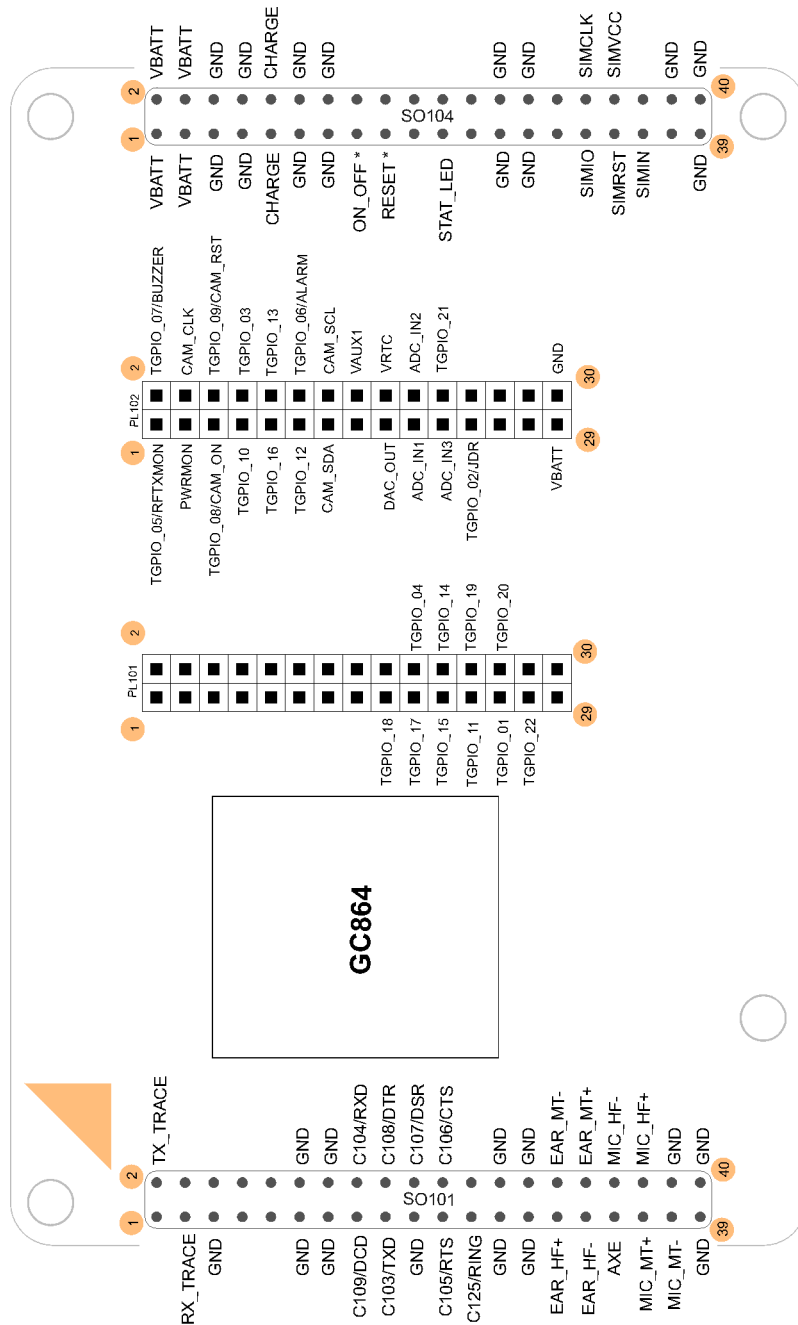

Position of GPIO ports on GC864 interface



### 43.1.8. GC864-C2 Interface (p/n 3990250683)

(Refer to schematic diagram 30276SE11231X)

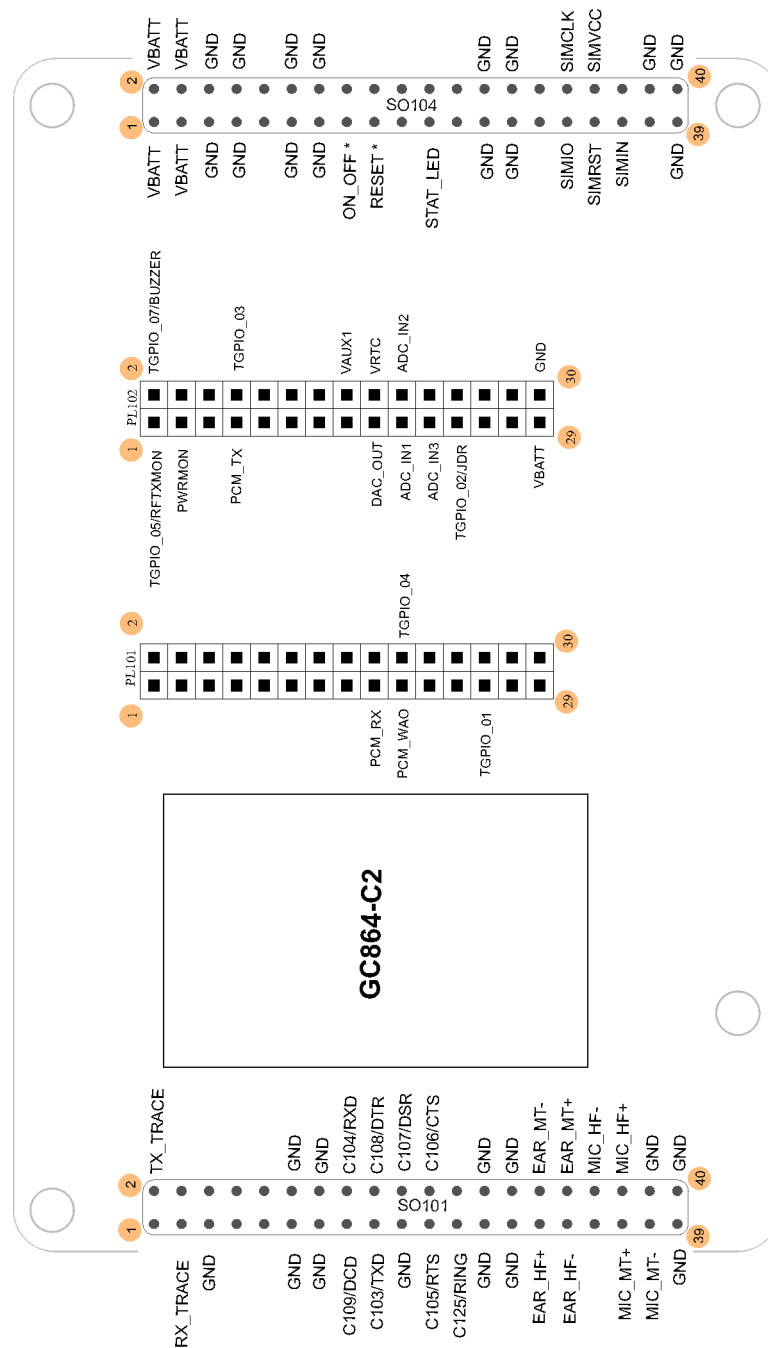

Position of GPIO ports on GC864-C2 interface





### 43.1.9. UC864 Interface

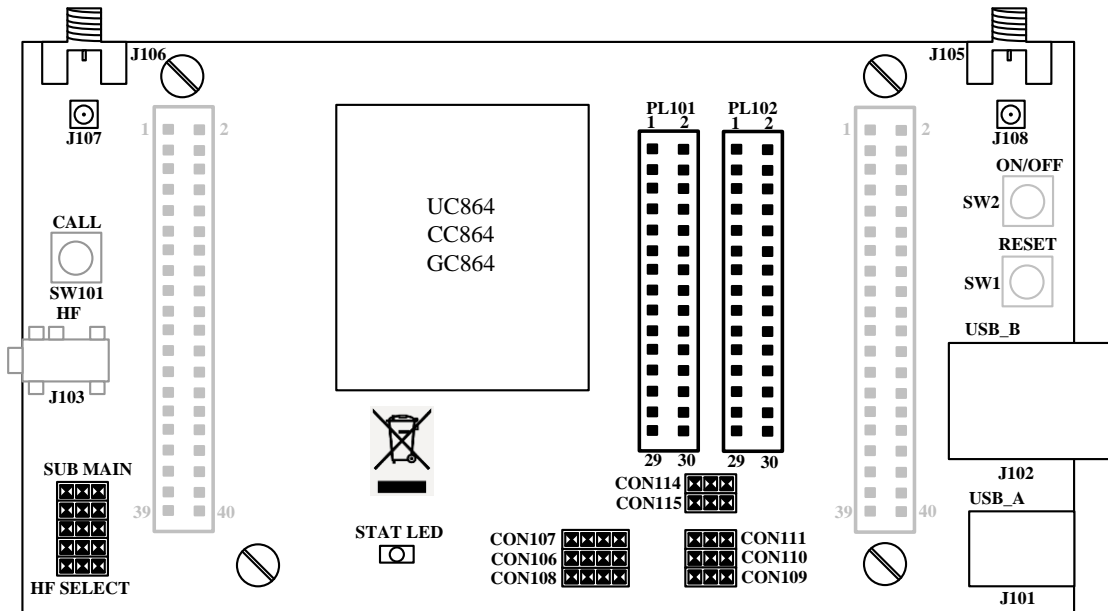

Position of GPIO on connectors of UC864 interface

PL101			
N.C	1	2	N.C
N.C	3	4	N.C
N.C	5	6	N.C
N.C	7	8	N.C
N.C	9	10	N.C
N.C	11	12	N.C
N.C	13	14	N.C
N.C	15	16	N.C
TGPIO_18/ PCM_RX	17	18	N.C
TGPIO_17/ PCM_SYNC	19	20	TGPIO_04
TGPIO_15	21	22	TGPIO_14
TGPIO_11	23	24	TGPIO_19
TGPIO_01	25	26	TGPIO_20
TGPIO_22	27	28	N.C
N.C	29	30	N.C

PL102			
TGPIO_05/ RTXMON	1	2	TGPIO_07/ BUZZER
PWRMON	3	4	RESERVED
TGPIO_08	5	6	TGPIO_09
TGPIO_10/ PCM_TX	7	8	TGPIO_03
TGPIO_16	9	10	TGPIO_13
TGPIO_12	11	12	TGPIO_06/ ALARM
PCM_CLOCK	13	14	USB_ID
N.C.	15	16	VAUX1
DAC_OUT	17	18	VRTC
ADC_IN1	19	20	ADC_IN2
ADC_IN3	21	22	TGPIO_21
TGPIO_02/JDR	23	24	N.C
N.C	25	26	N.C
RESERVED	27	28	RESERVED
VBATT	29	30	GND

GPIO pin positioning



### 43.1.10. HE910 Interface

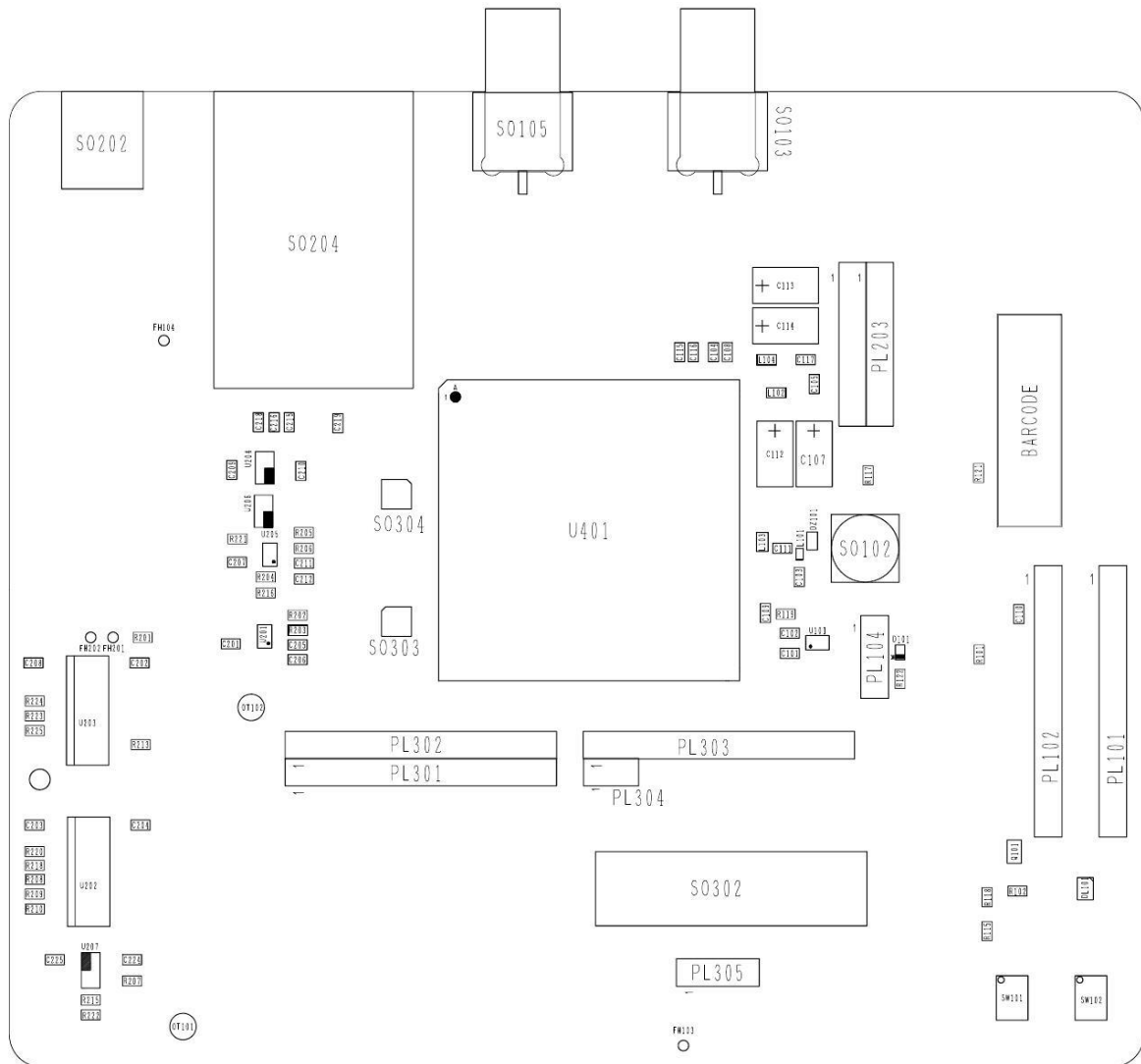

Position of GPIO on connectors of HE910 interface





### 43.1.11. GE910 Interface

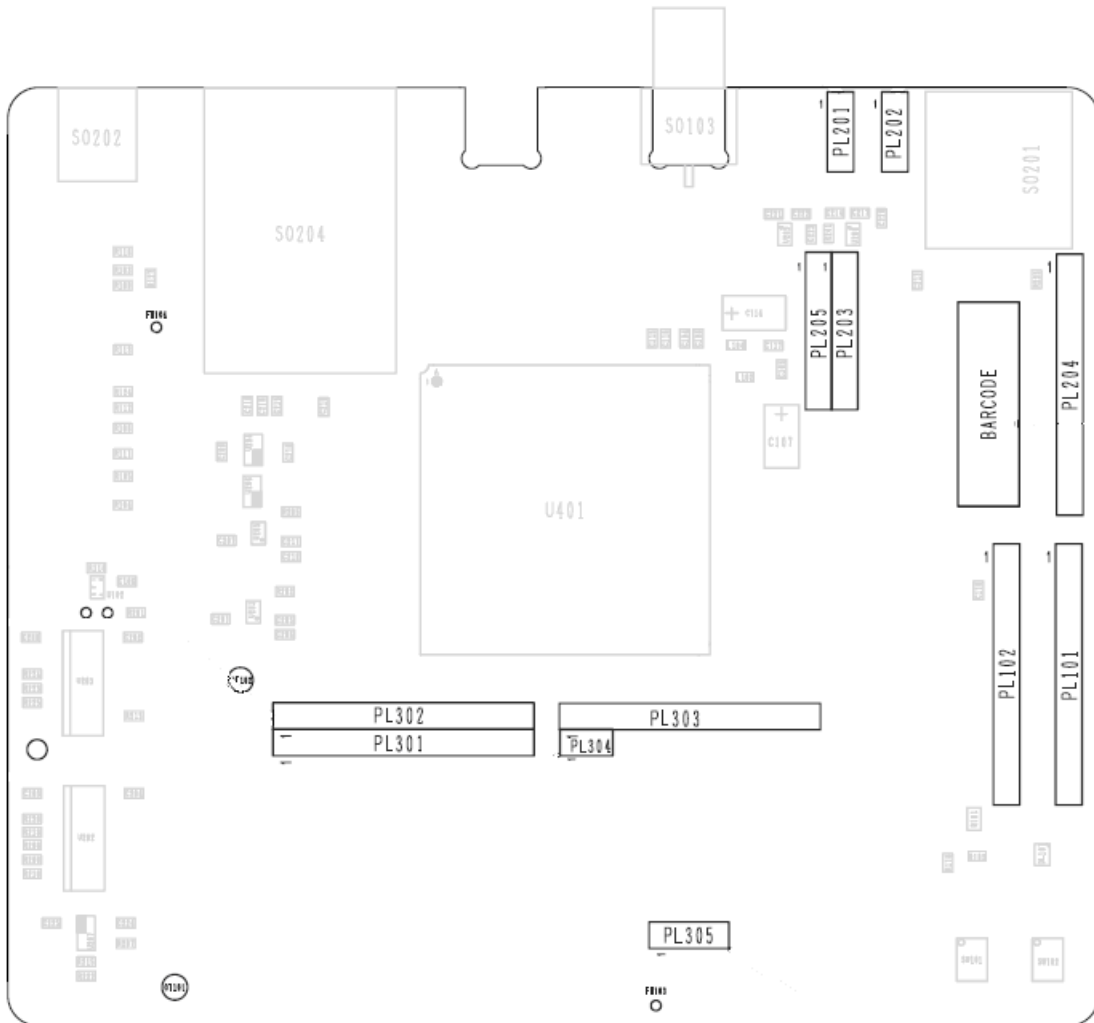

Position of GPIO on connectors of GE910 interface



The connectors are carrying the following signals:

Pin Name	Pin/Connector
GPIO_01	Pin 1 (PL302)
GPIO_02	Pin 2 (PL302)
GPIO_03	Pin 3 (PL302)
GPIO_04	Pin 4 (PL302)
GPIO_05	Pin 6 (PL102)
GPIO_06	Pin 5 (PL302)
GPIO_07	Pin 6 (PL302)
GPIO_08	Pin 6 (PL303)
GPIO_09	Pin 7 (PL303)
GPIO_10	Pin 8 (PL303)

PL305		
Pin#	Pin Name	Description
1	-	Reserved
2	VDD_IO	Input pin for the bus supply
3	VIO_1V8	VIO supply at 1.8V





### 43.1.12. DE910 Interface

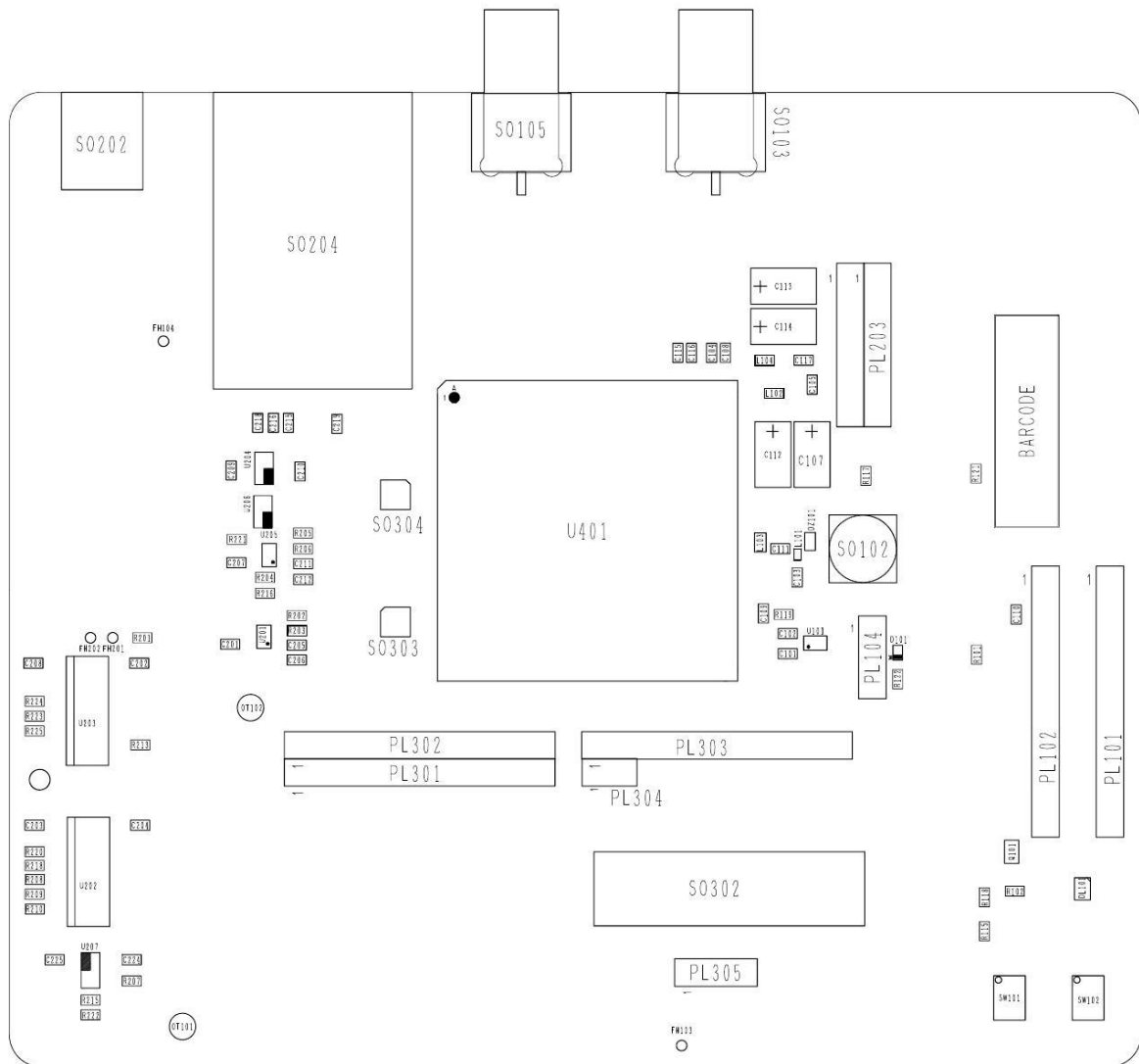

Position of GPIO on connectors of DE910 interface



The connectors are carrying the following signals:

Pin Name	Pin/Connector
GPIO_01	Pin 1 (PL302)
GPIO_02	Pin 2 (PL302)
GPIO_03	Pin 3 (PL302)
GPIO_04	Pin 4 (PL302)
GPIO_05	Pin 6 (PL102)
GPIO_06	Pin 5 (PL302)
GPIO_07	Pin 6 (PL302)
GPIO_08	Pin 6 (PL303)
GPIO_09	Pin 7 (PL303)
GPIO_10	Pin 8 (PL303)

PL305		
Pin#	Pin Name	Description
1	-	Reserved
2	VDD_IO	Input pin for the bus supply
3	VIO_1V8	VIO supply at 1.8V



### 43.1.13. CE910 Interface

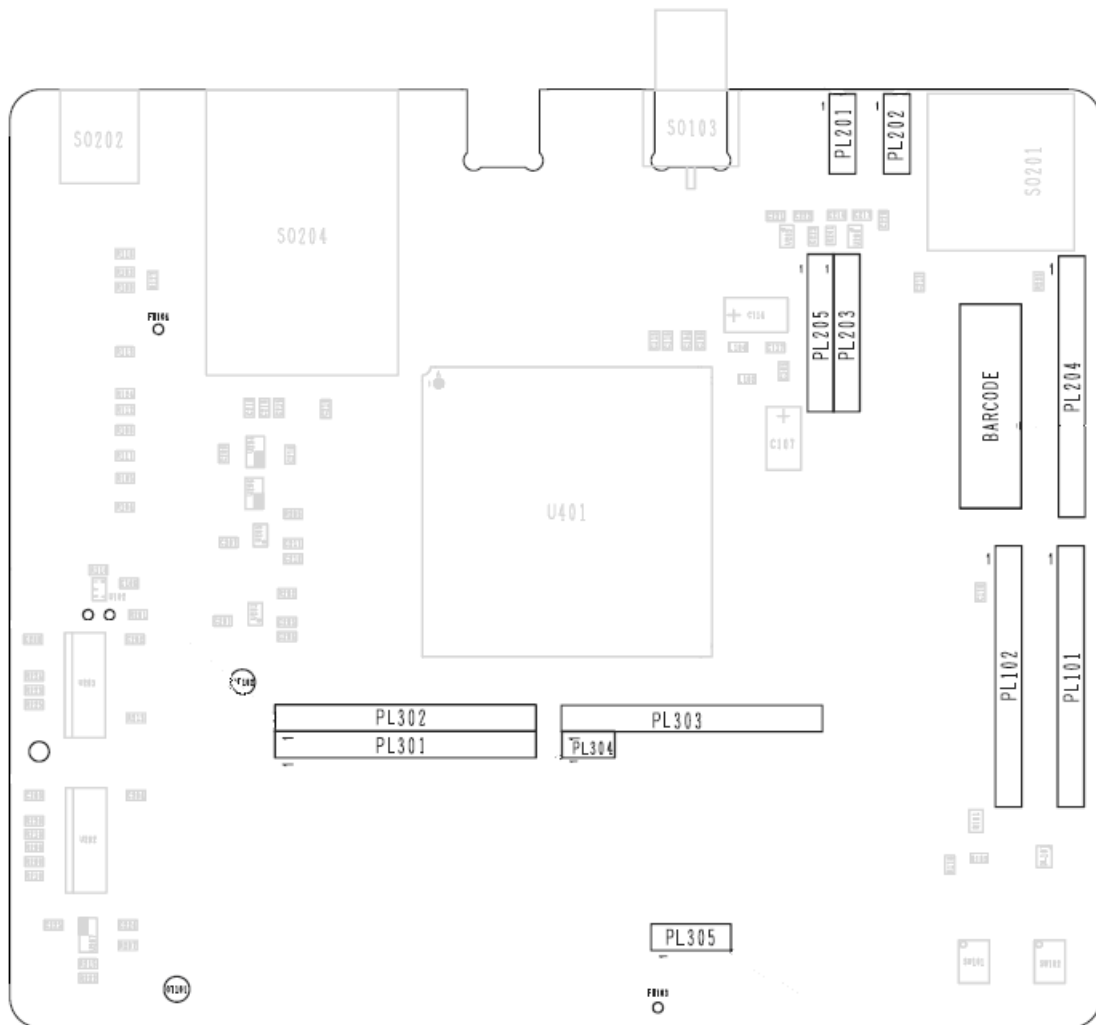

Position of GPIO on connectors of CE910 interface



The connectors are carrying the following signals:

Pin Name	Pin/Connector
GPIO_01	Pin 1 (PL302)
GPIO_02	Pin 2 (PL302)
GPIO_03	Pin 3 (PL302)
GPIO_04	Pin 4 (PL302)
GPIO_05	Pin 6 (PL102)
GPIO_06	Pin 5 (PL302)
GPIO_07	Pin 6 (PL302)
GPIO_08	Pin 6 (PL303)
GPIO_09	Pin 7 (PL303)
GPIO_10	Pin 8 (PL303)



### 43.1.14. GL865 V3 Interface

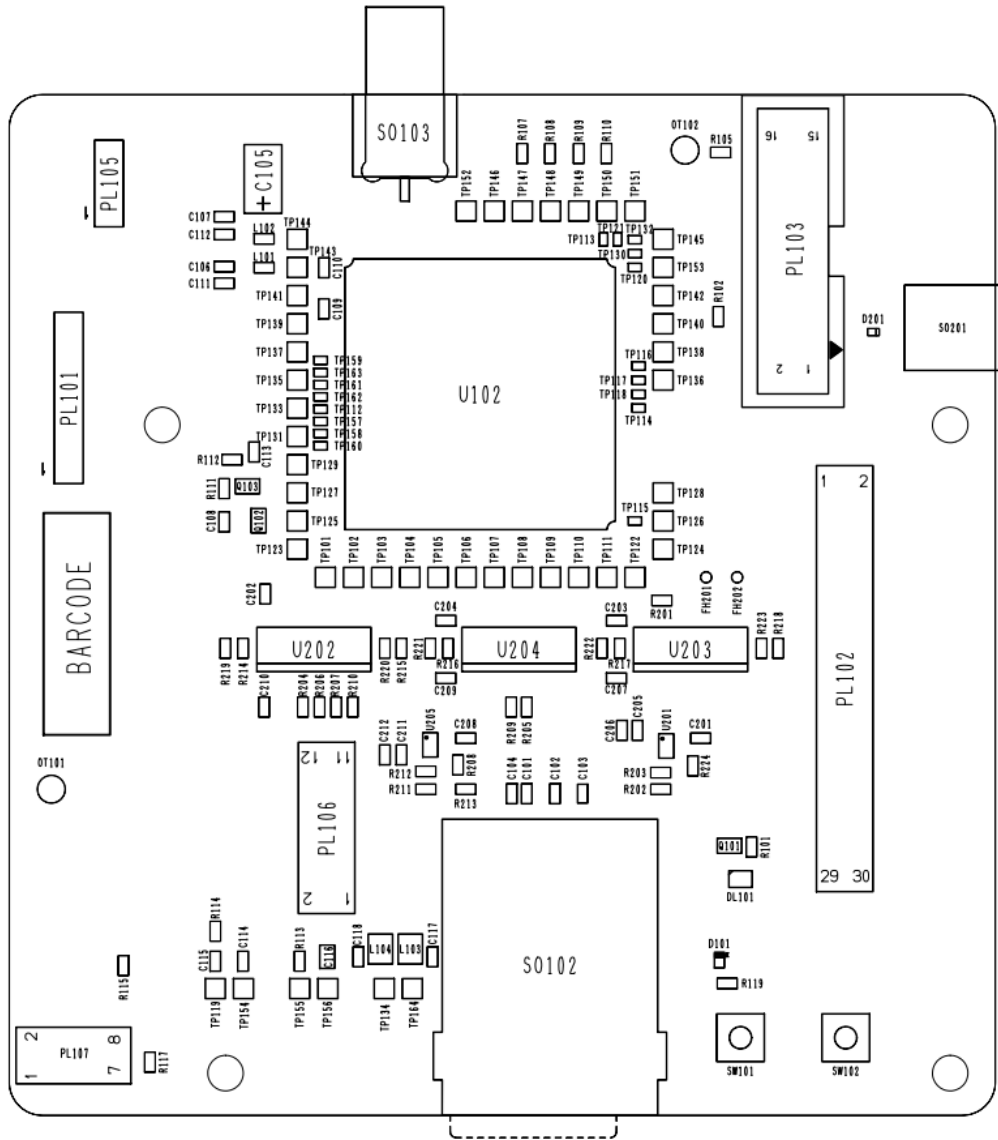

Position of GPIO on connectors of GL865 V3 interface





The connectors are carrying the following signals:

Pin Name	Pin/Connector
GPIO_01	Pin 6 (PL102) / Pin 4 (PL106)
GPIO_02	Pin 23 (PL102) / Pin 2 (PL106)
GPIO_03	Pin 8 (PL102) / Pin 6 (PL106)
GPIO_04	Pin 7 (PL102) / Pin 8 (PL106)
GPIO_05	Pin 1 (PL102)
GPIO_06	Pin 12 (PL102)
GPIO_07	Pin 2 (PL102) / Pin 7 (PL106) / Pin 3 (PL101)
GPIO_08	Pin 5 (PL102) / Pin 9 (PL106) / Pin 4 (PL101)



### 43.1.15. UL865 Interface

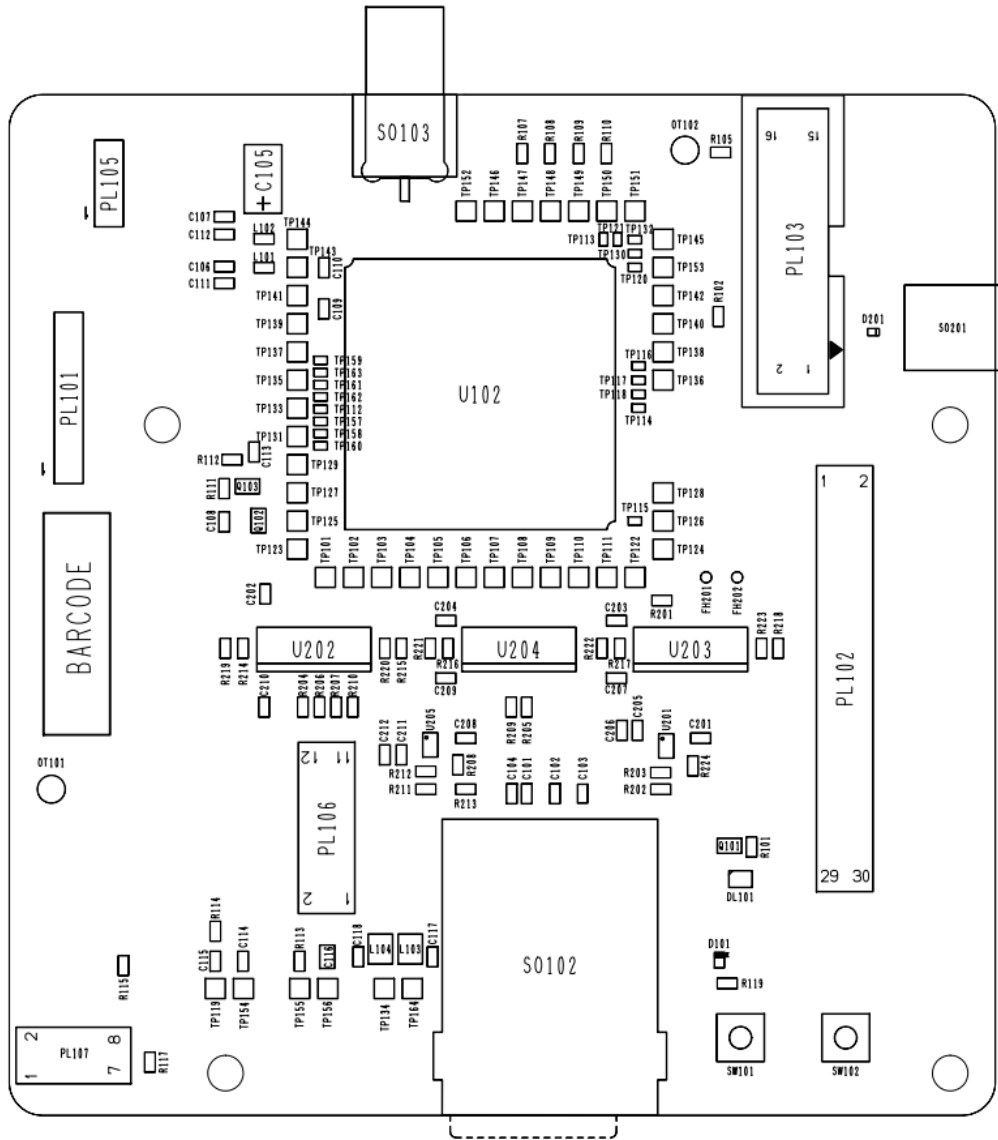

Position of GPIO on connectors of UL865 interface



The connectors are carrying the following signals:

Pin Name	Pin/Connector
GPIO_01	Pin 6 (PL102) / Pin 4 (PL106)
GPIO_02	Pin 23 (PL102) / Pin 2 (PL106)
GPIO_03	Pin 8 (PL102) / Pin 6 (PL106)
GPIO_04	Pin 7 (PL102) / Pin 8 (PL106)
GPIO_05	Pin 1 (PL102)
GPIO_06	Pin 12 (PL102)
GPIO_07	Pin 2 (PL102) / Pin 7 (PL106) / Pin 3 (PL101)
GPIO_08	Pin 5 (PL102) / Pin 9 (PL106) / Pin 4 (PL101)



### 43.1.16. HE920 Family Interface

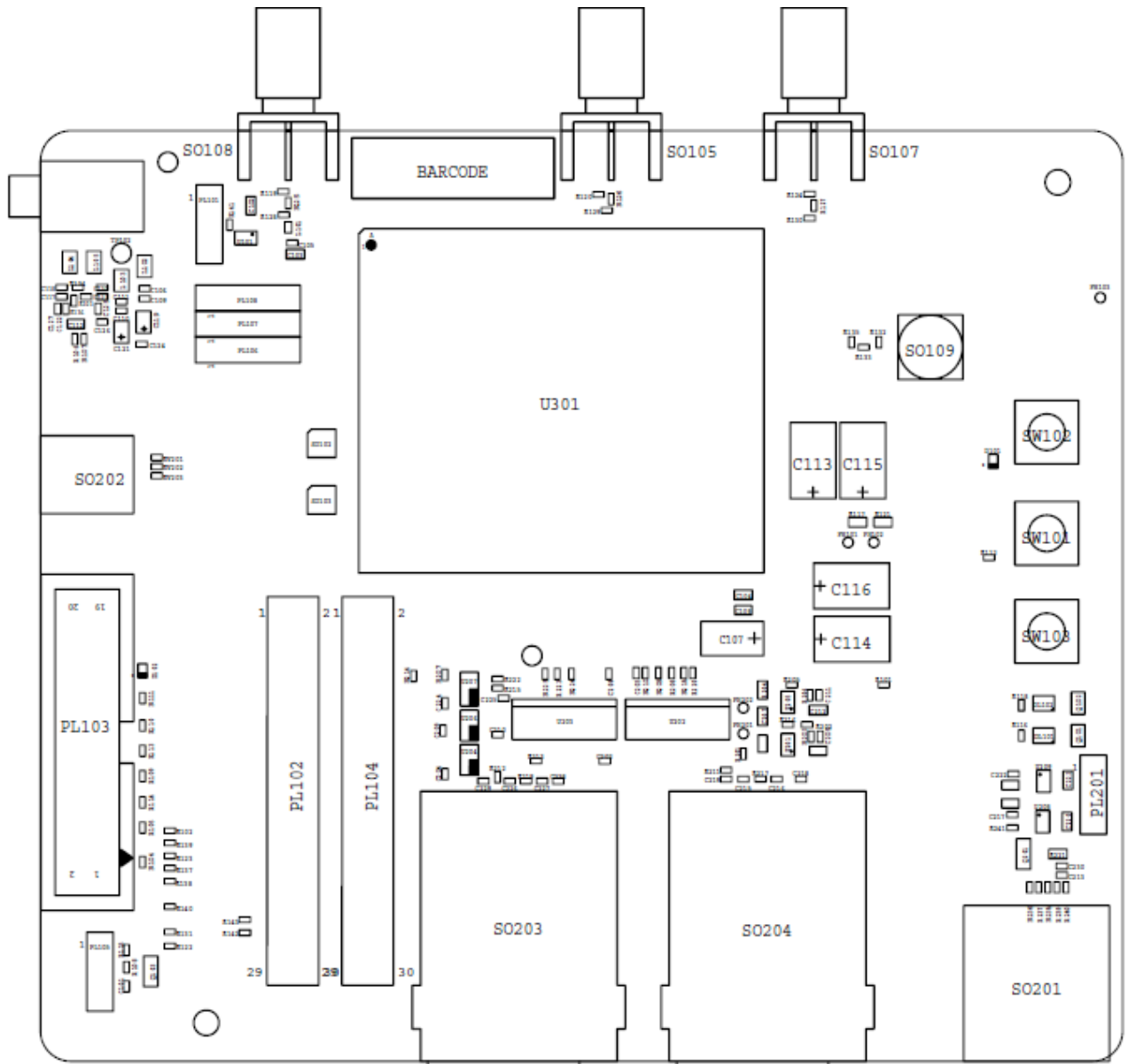

Position of GPIO on connectors of HE920 interface



The connectors are carrying the following signals:

Pin Name	Pin/Connector
GPIO_01	Pin 25 (PL102)
GPIO_02	Pin 23 (PL104)
GPIO_03	Pin 8 (PL104)
GPIO_04	Pin 20 (PL102)
GPIO_05	Pin 1 (PL104)
GPIO_06	Pin 12 (PL104)
GPIO_07	Pin 2 (PL104)
GPIO_08	Pin 5 (PL104)
GPIO_09	Pin 6 (PL104)
GPIO_10	Pin 7 (PL104)





### 43.1.17. HE910 V2 Interface

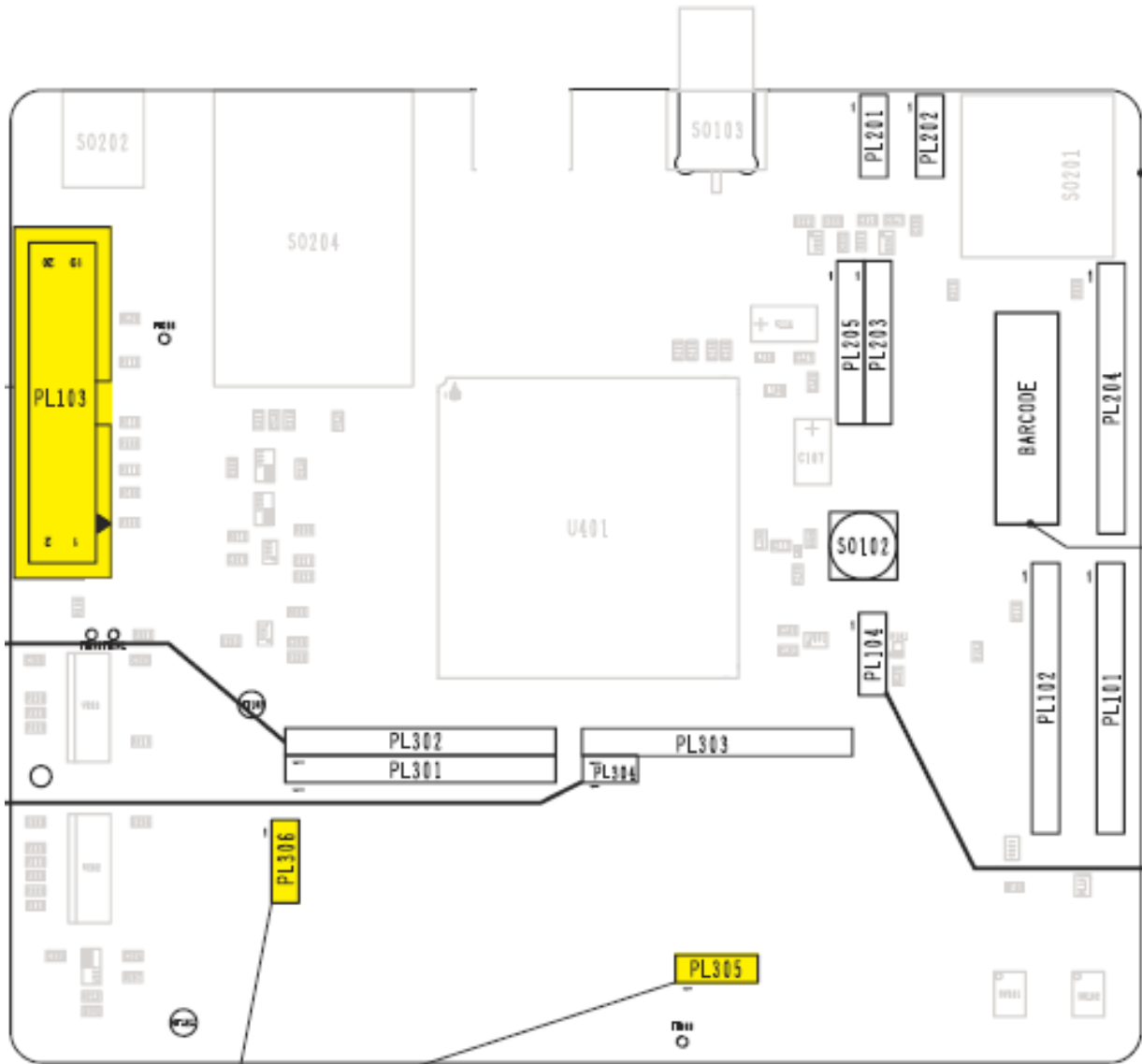

Position of GPIO on connectors of HE910 V2 interface



The connectors are carrying the following signals:

Pin Name	Pin/Connector
GPIO_01	Pin 1 (PL302)
GPIO_02	Pin 2 (PL302)
GPIO_03	Pin 3 (PL302)
GPIO_04	Pin 4 (PL302)
GPIO_05	Pin 6 (PL102)
GPIO_06	Pin 5 (PL302)
GPIO_07	Pin 6 (PL302)
GPIO_08	Pin 6 (PL303)
GPIO_09	Pin 7 (PL303)
GPIO_10	Pin 8 (PL303)

PL305		
Pin#	Pin Name	Description
1	-	Reserved
2	VDD_IO	Input pin for the bus supply
3	VIO_1V8	VIO supply at 1.8V



### 43.1.18. UE910 V2 Interface

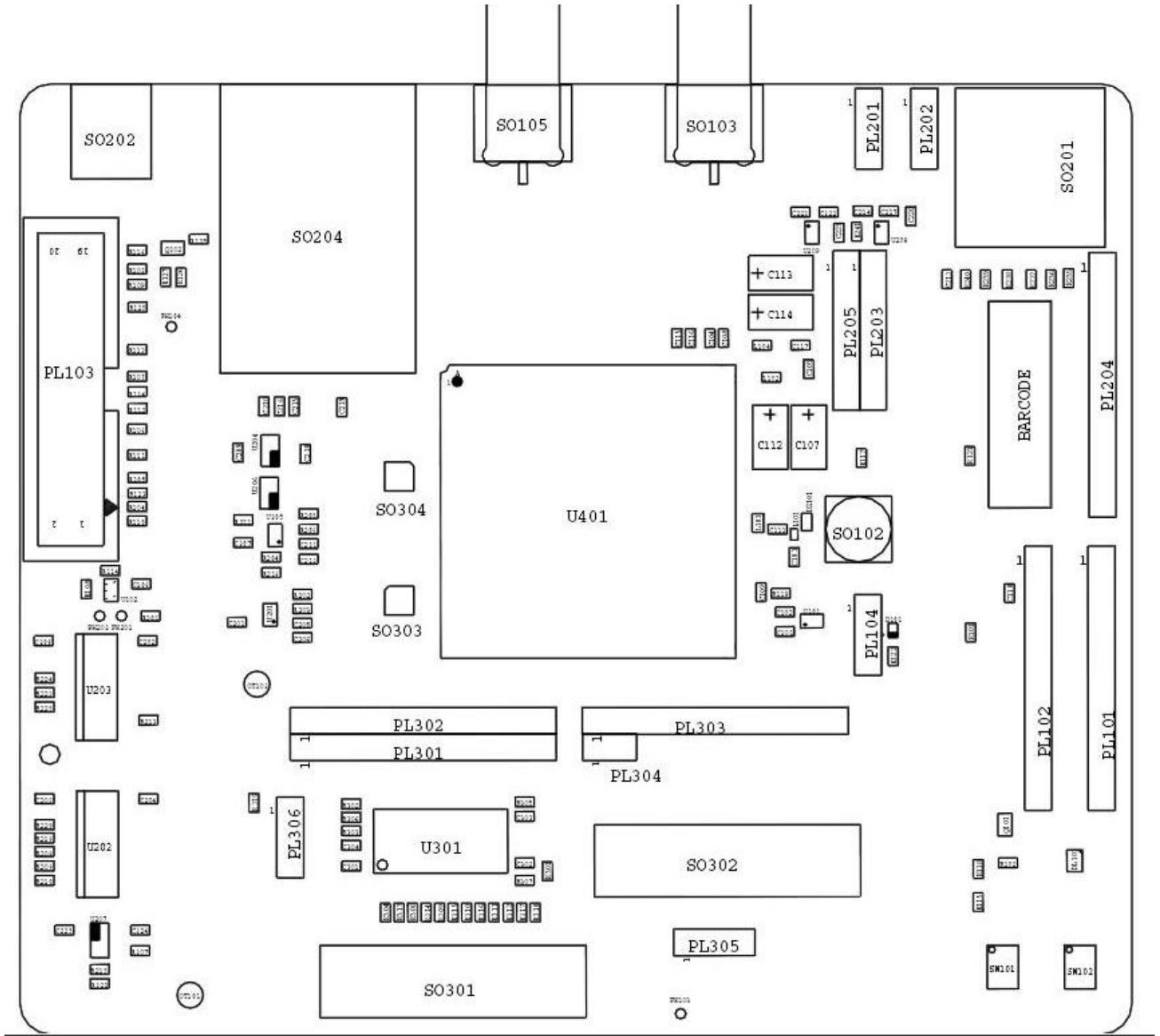

Position of GPIO on connectors of UE910 V2 interface



The connectors are carrying the following signals:

Pin Name	Pin/Connector
GPIO_01	Pin 1 (PL302)
GPIO_02	Pin 2 (PL302)
GPIO_03	Pin 3 (PL302)
GPIO_04	Pin 4 (PL302)
GPIO_05	Pin 6 (PL102)
GPIO_06	Pin 5 (PL302)
GPIO_07	Pin 6 (PL302)
GPIO_08	Pin 6 (PL303)
GPIO_09	Pin 7 (PL303)
GPIO_10	Pin 8 (PL303)

PL305		
Pin#	Pin Name	Description
1	-	Reserved
2	VDD_IO	Input pin for the bus supply
3	VIO_1V8	VIO supply at 1.8V



### 43.1.19. CL865 Interface

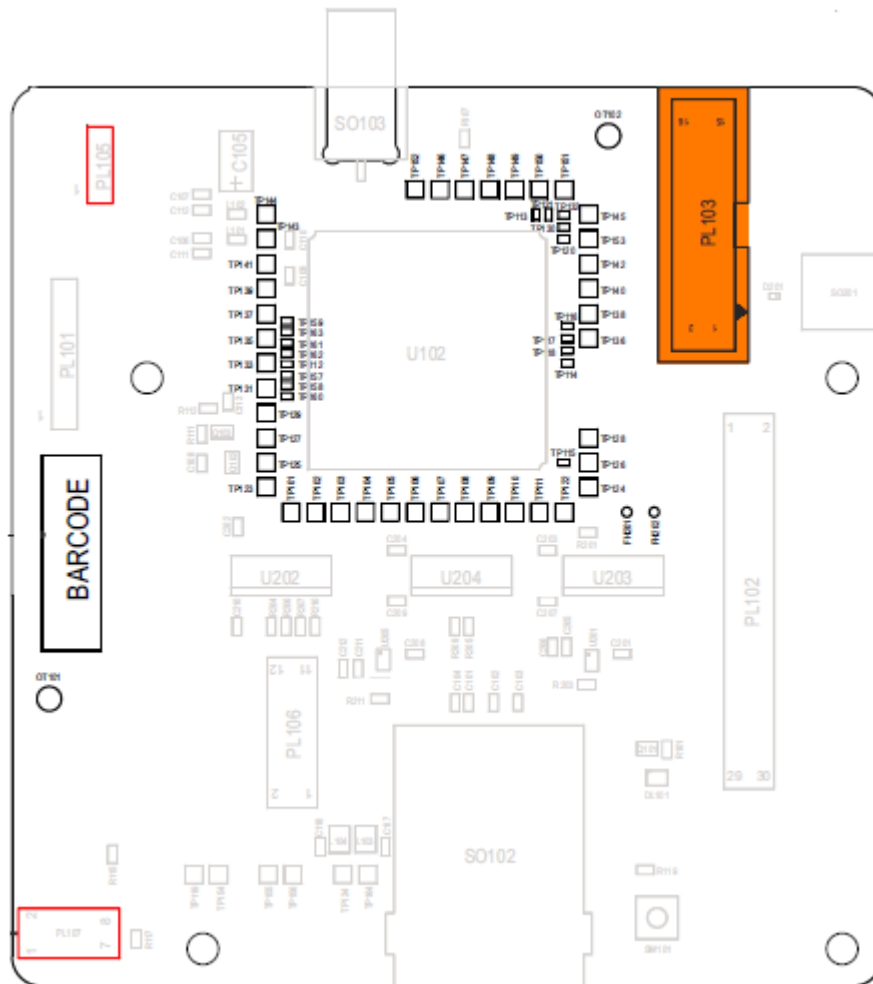

Position of GPIO on connectors of CL865 interface





### 43.1.20. GE866-QUAD Interface

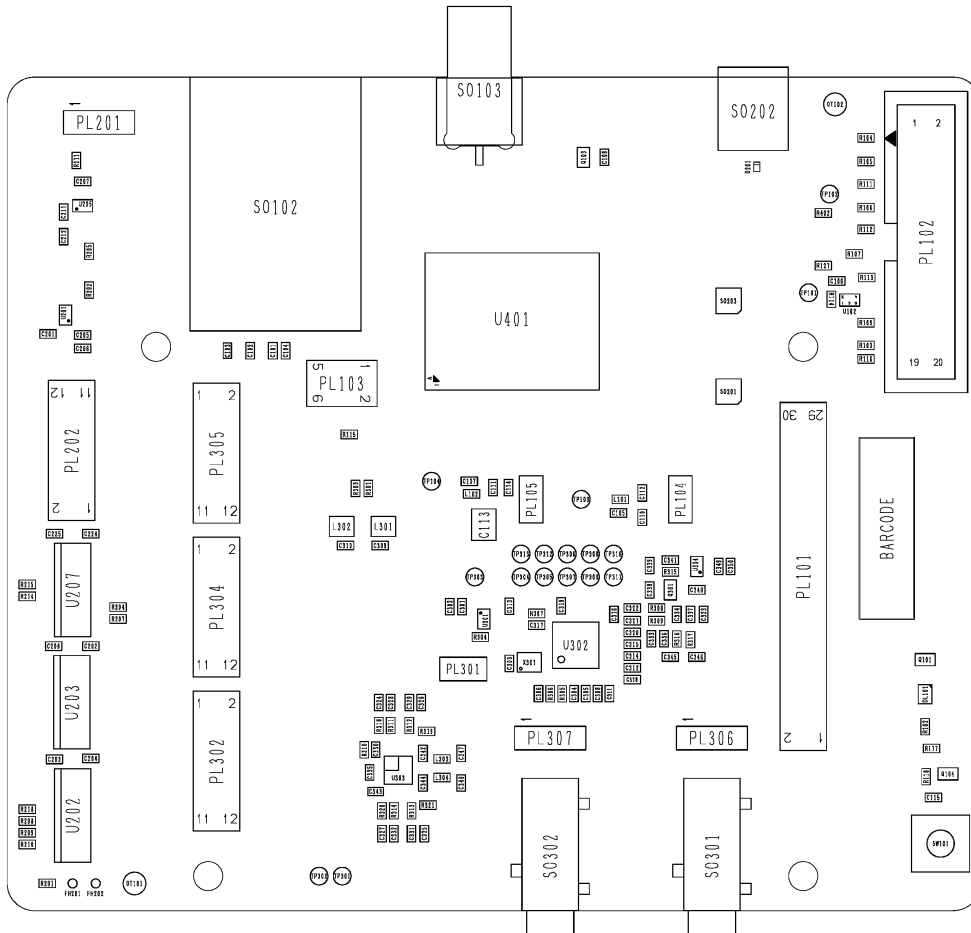

Layout of GE866-QUAD Interface

Pin Name	Pin/Connector
GPIO_01	Pin 6 (PL101) / Pin 3 (PL302)
GPIO_02	Pin 23 (PL101) / Pin 1 (PL302)
GPIO_03	Pin 8 (PL101) / Pin 5 (PL302)
GPIO_04	Pin 7 (PL101) / Pin 7 (PL302)
GPIO_05	Pin 1 (PL101) / Pin 2 (PL103) / Pin 11 (PL302)
GPIO_06	Pin 12 (PL101) / Pin 4 (PL103) / Pin 9 (PL302)
GPIO_07	Pin 5 (PL101) / Pin 6 (PL103)



### 43.1.21. UE866 Interface

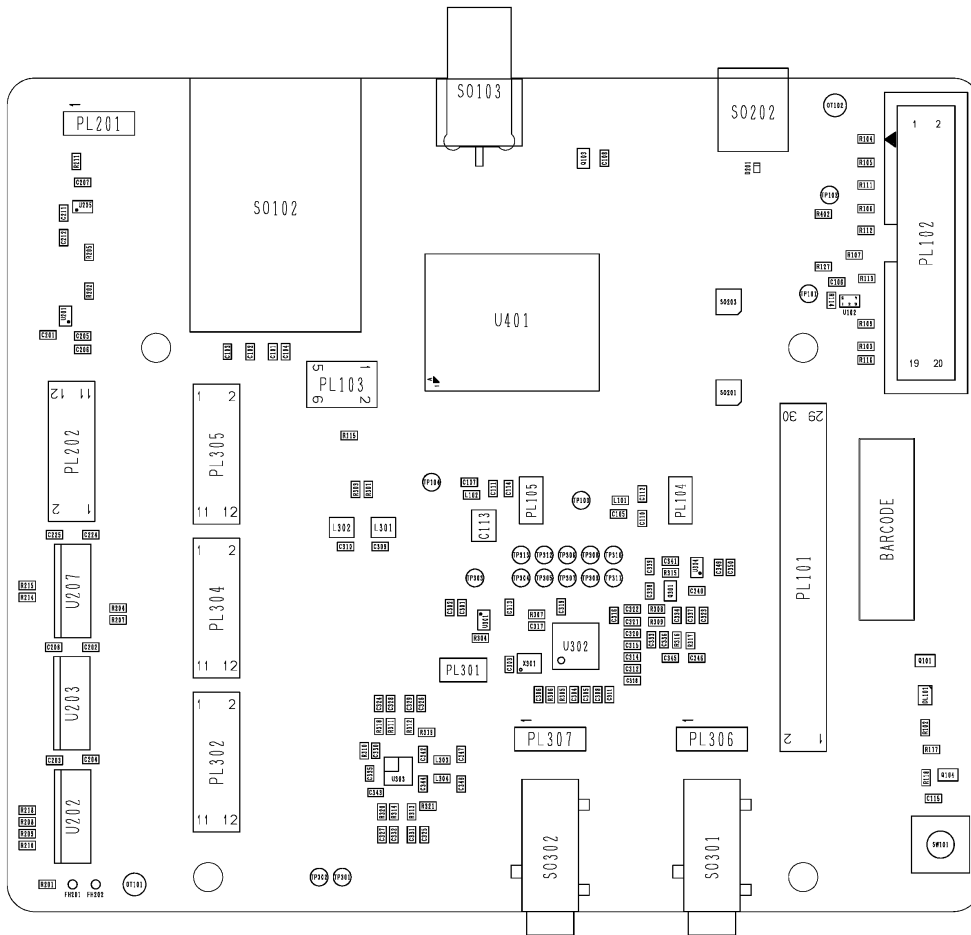

Layout of UE866 Interface

Pin Name	Pin/Connector
GPIO_01	Pin 6 (PL101) / Pin 3 (PL302)
GPIO_02	Pin 23 (PL101) / Pin 1 (PL302)
GPIO_03	Pin 8 (PL101) / Pin 5 (PL302)
GPIO_04	Pin 7 (PL101) / Pin 7 (PL302)
GPIO_05	Pin 1 (PL101) / Pin 2 (PL103) / Pin 11 (PL302)
GPIO_06	Pin 12 (PL101) / Pin 4 (PL103) / Pin 9 (PL302)
GPIO_07	Pin 5 (PL101) / Pin 6 (PL103)



### 43.1.22. LE910 Interface

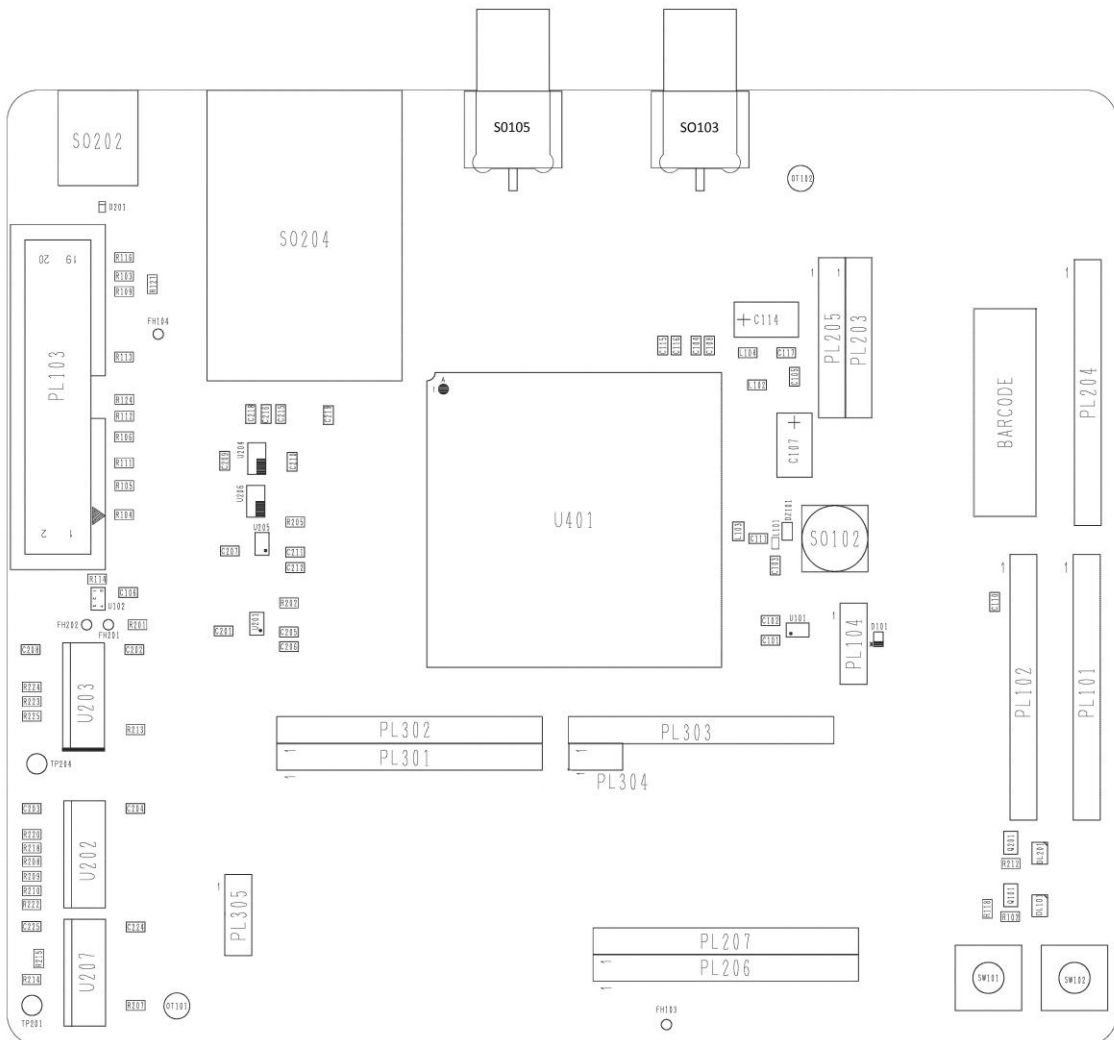

Position of GPIO on connectors of LE910 interface



The connectors are carrying the following signals:

Pin Name	Pin/Connector
GPIO_01	Pin 1 (PL302)
GPIO_02	Pin 2 (PL302)
GPIO_03	Pin 3 (PL302)
GPIO_04	Pin 4 (PL302)
GPIO_05	Pin 6 (PL102)
GPIO_06	Pin 5 (PL302)
GPIO_07	Pin 6 (PL302)
GPIO_08	Pin 6 (PL303)
GPIO_09	Pin 7 (PL303)
GPIO_10	Pin 8 (PL303)



## 44. SCHEMATICS

In the following paragraphs the user can find the schematics related to all EVK2 boards, therefore to the Mother Board, to the Interface Boards and to the Extension Boards.





## 44.1. EVK2 Mother Board

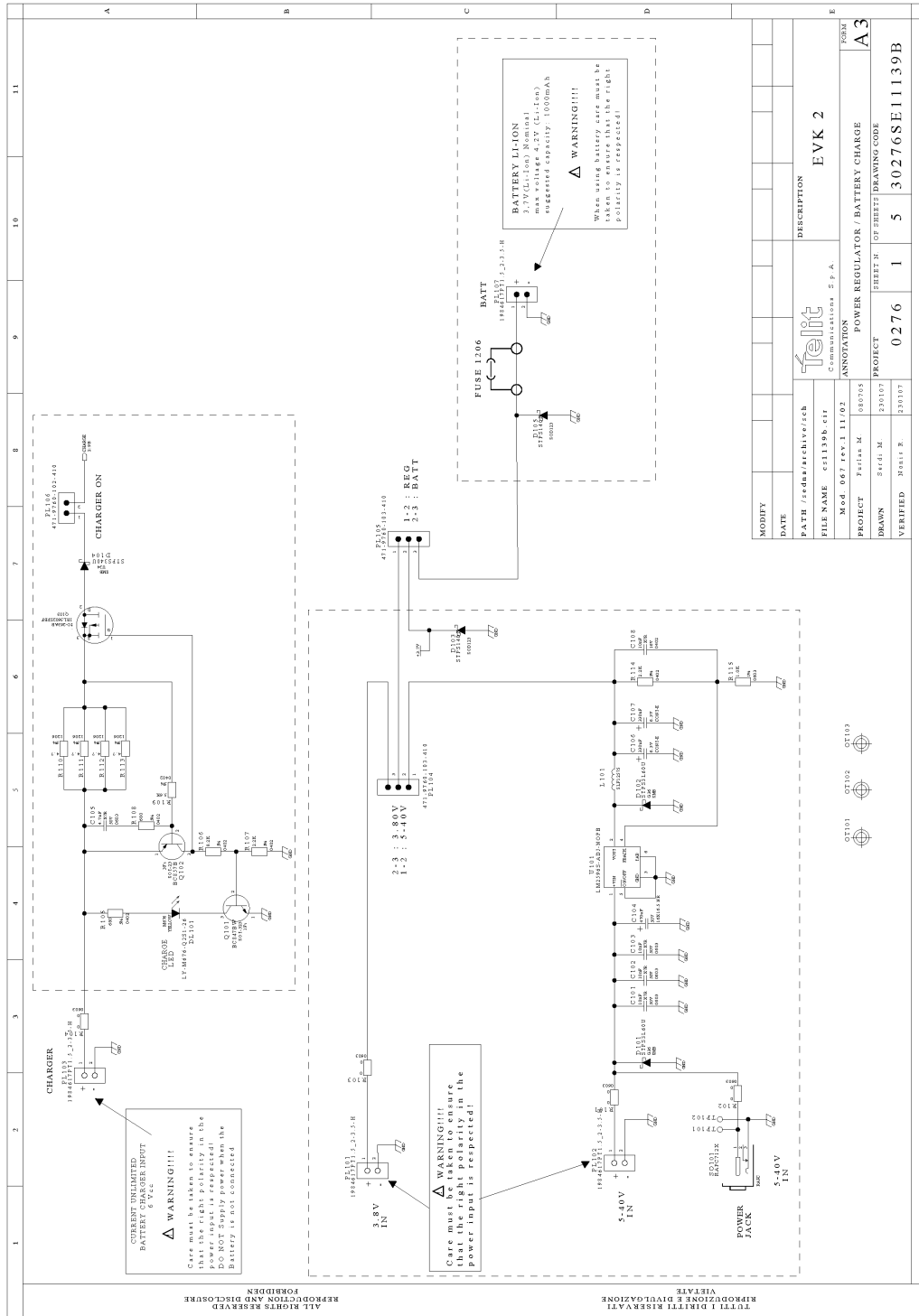

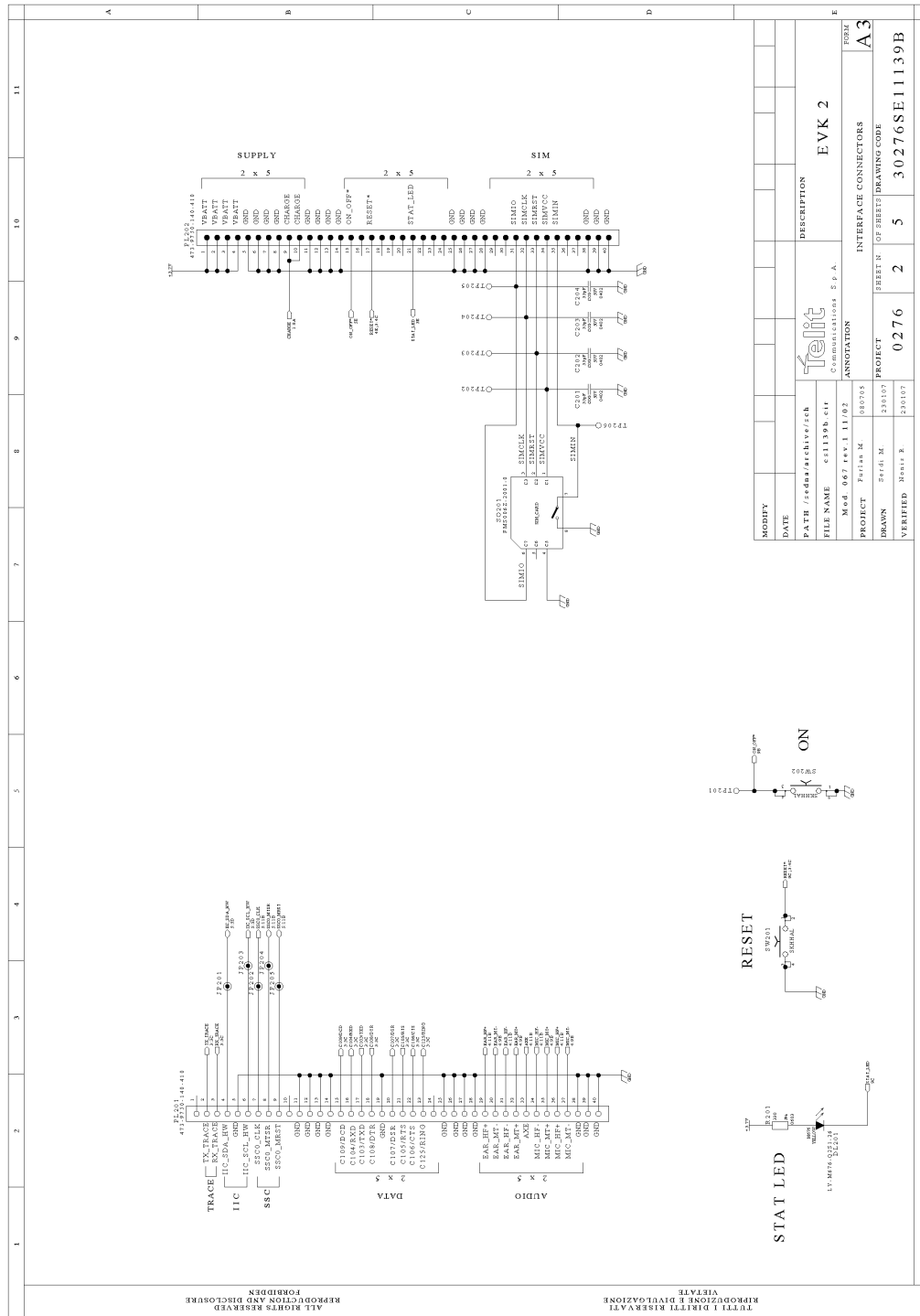

MODIFY	DATE	DESCRIPTION
		EVK 2
FILE NAME	621139B_614	COMMUNICATIONS S.p.A.
Mod.	067 rev. I 11/02	ANNOTATION
PROJECT	Perlan M	080785
DRAWN	Sechi M	230107
VERIFIED	Naris R	230107
		INTERFACE CONNECTORS
		SHEET N. OF SHEETS DRAWING CODE
	2	5
	0276	30276SE11139B



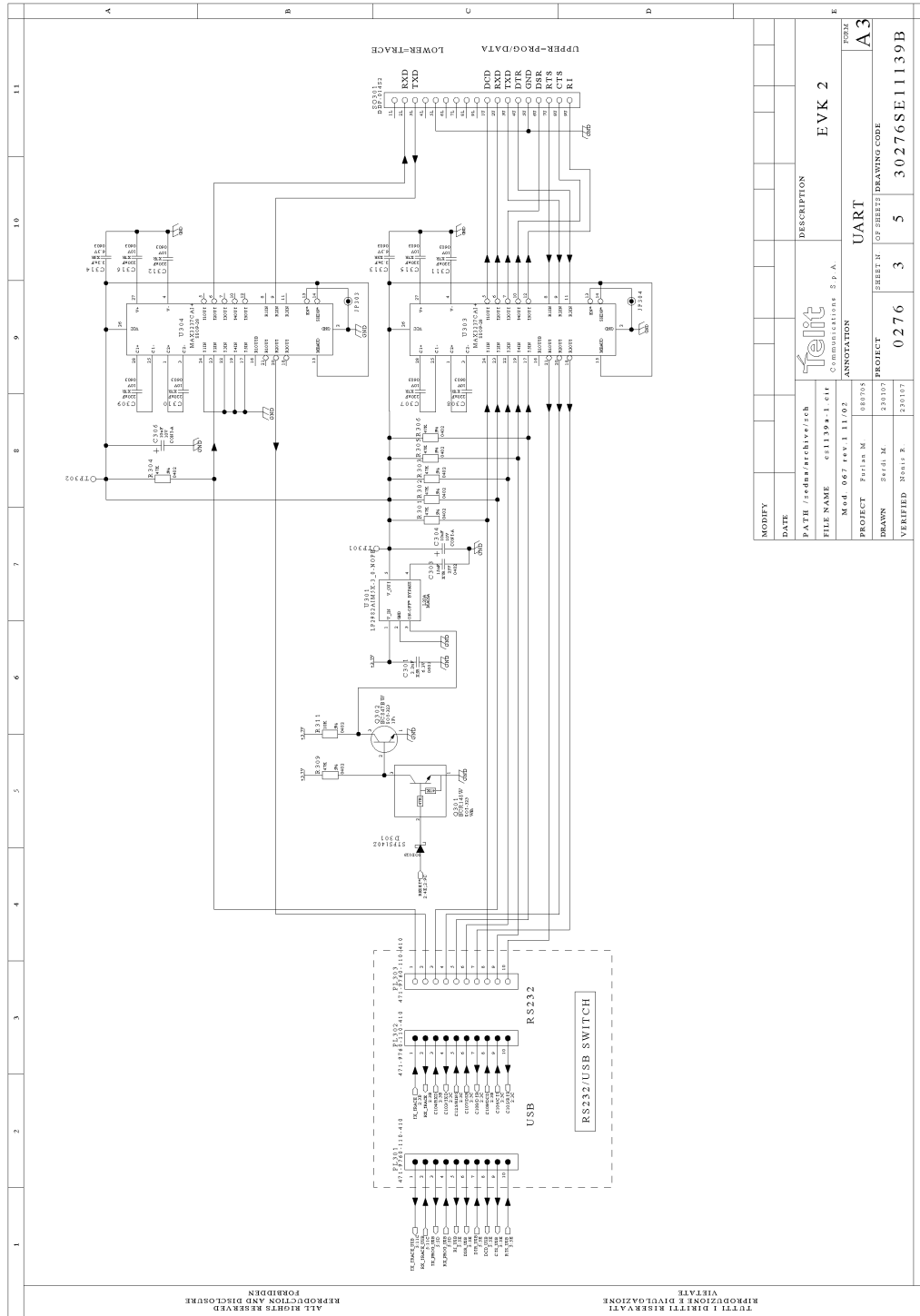



# Telit EVK2 User Guide

1w0300704 Rev.19 – 2015/01/26

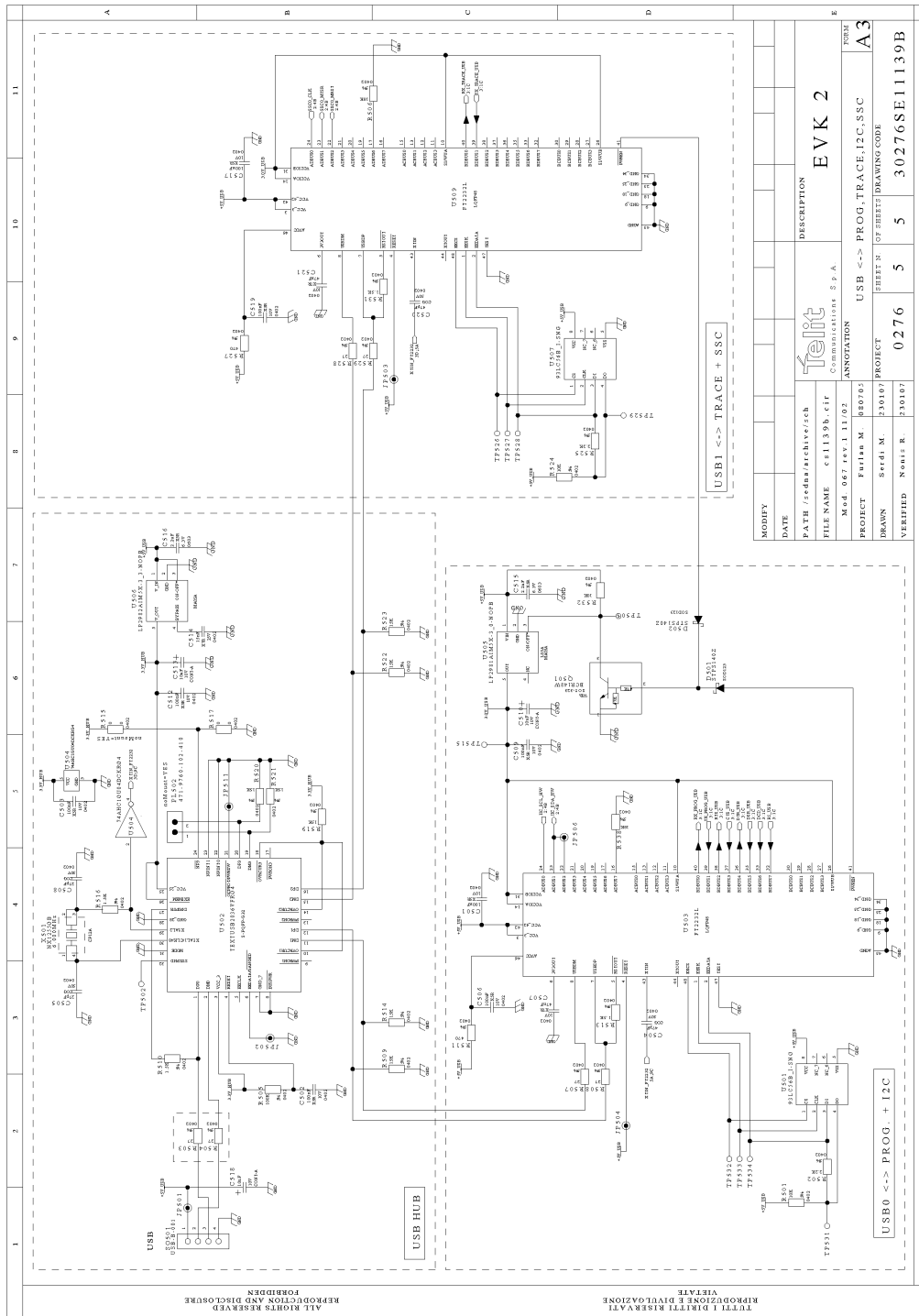



## 44.2. GM862 Interface Board

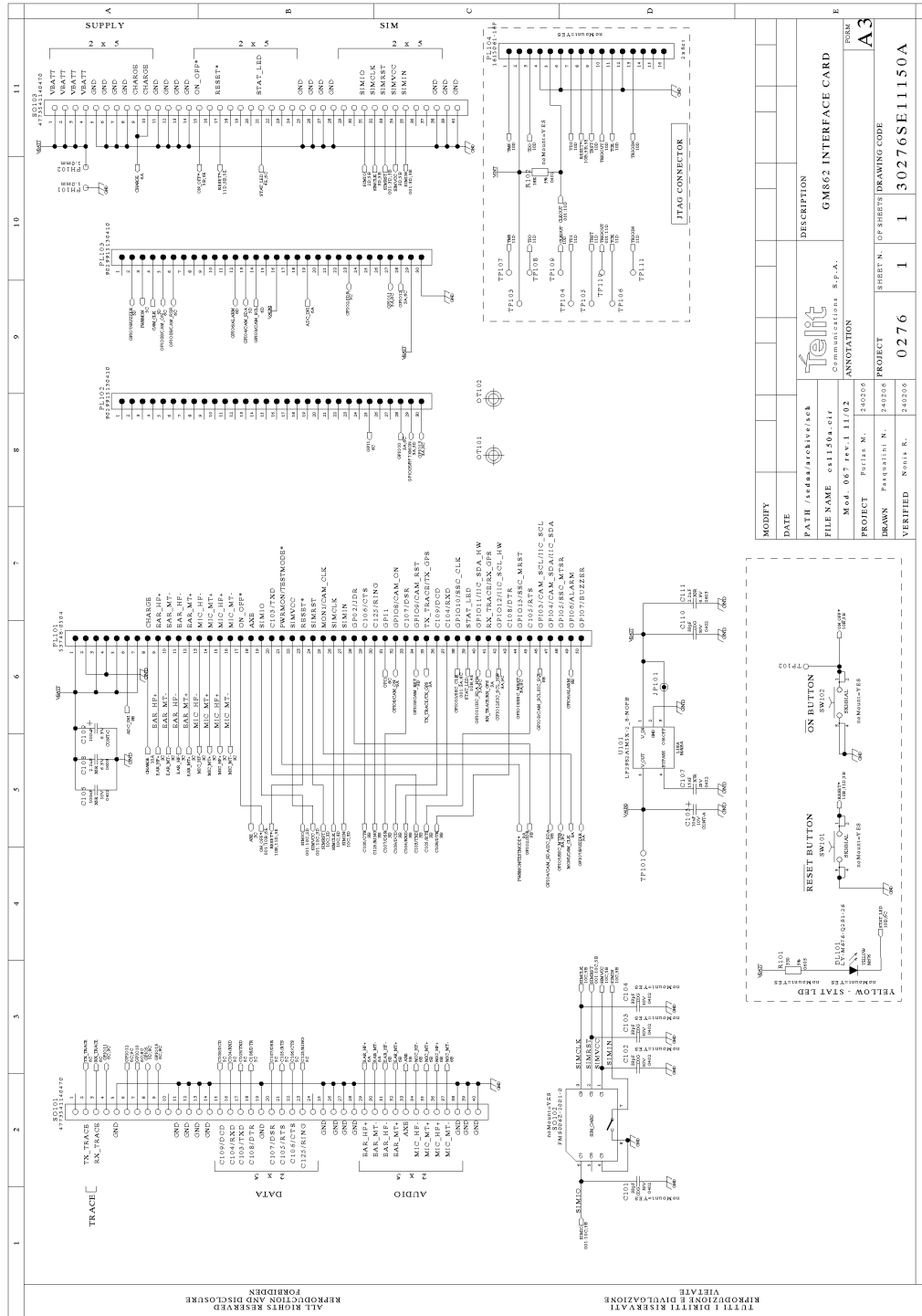

### 44.3. GE863 Interface Board

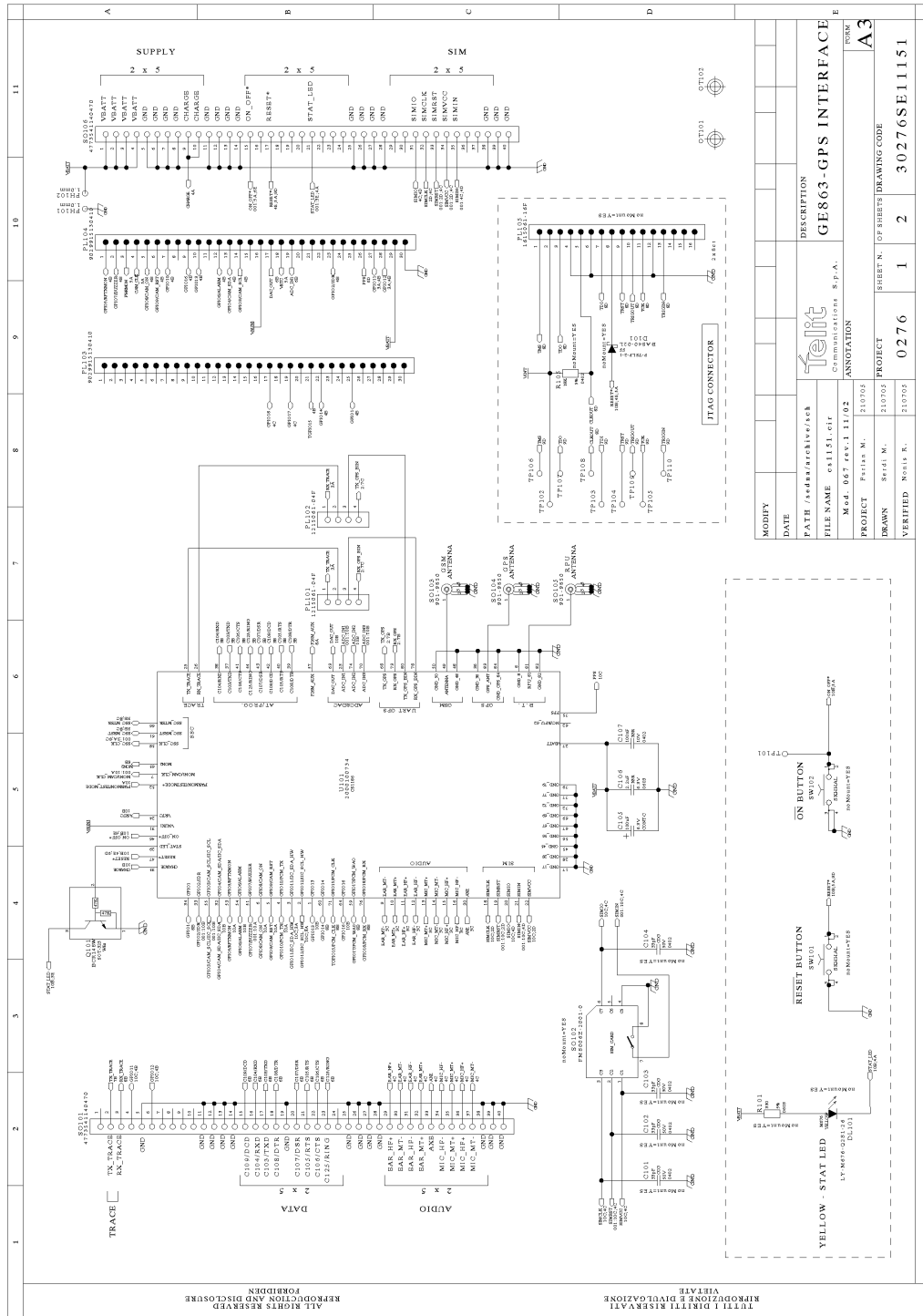



## 44.4. GE864 Interface board

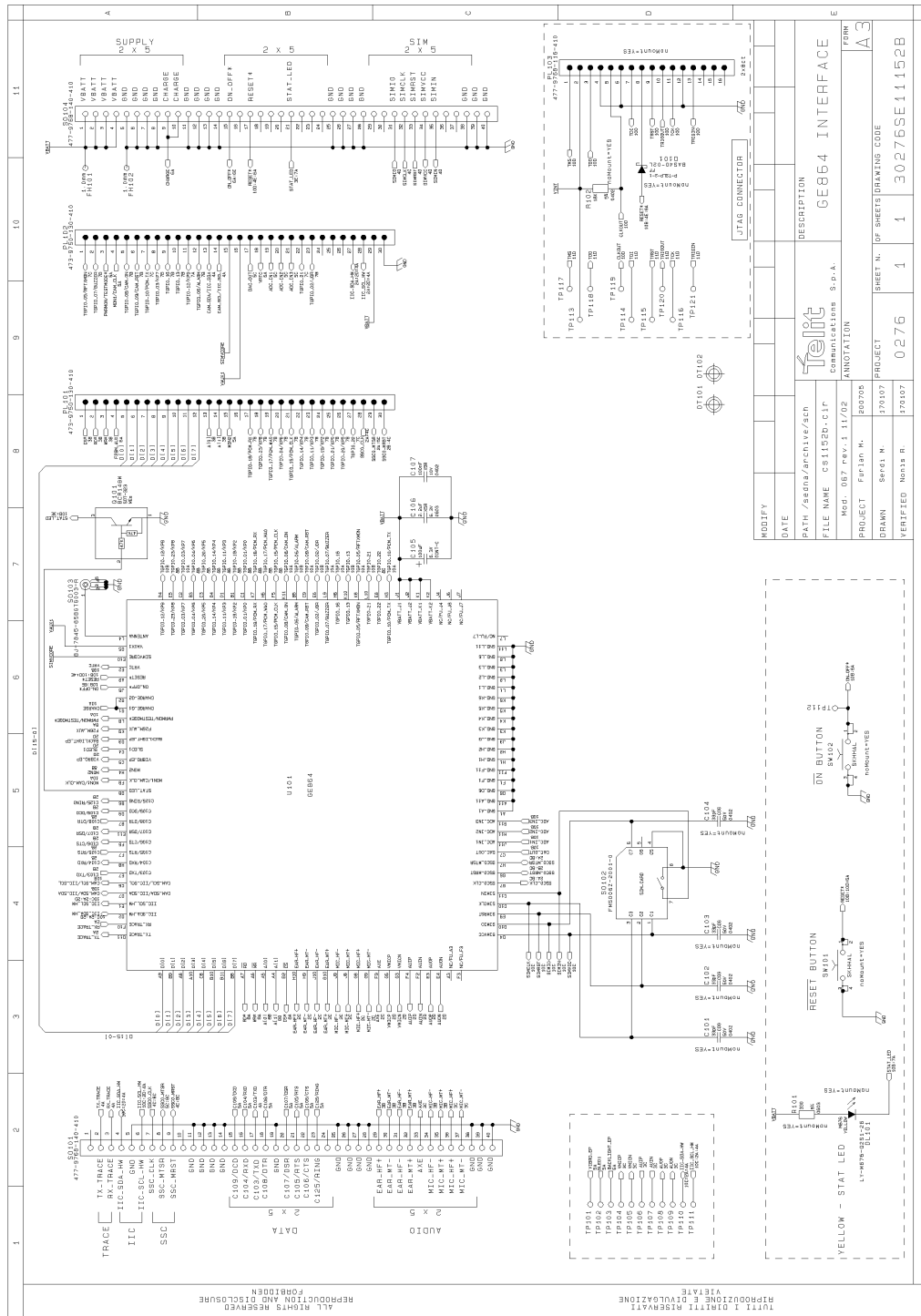





# 44.6. GE864 Interface board – V2

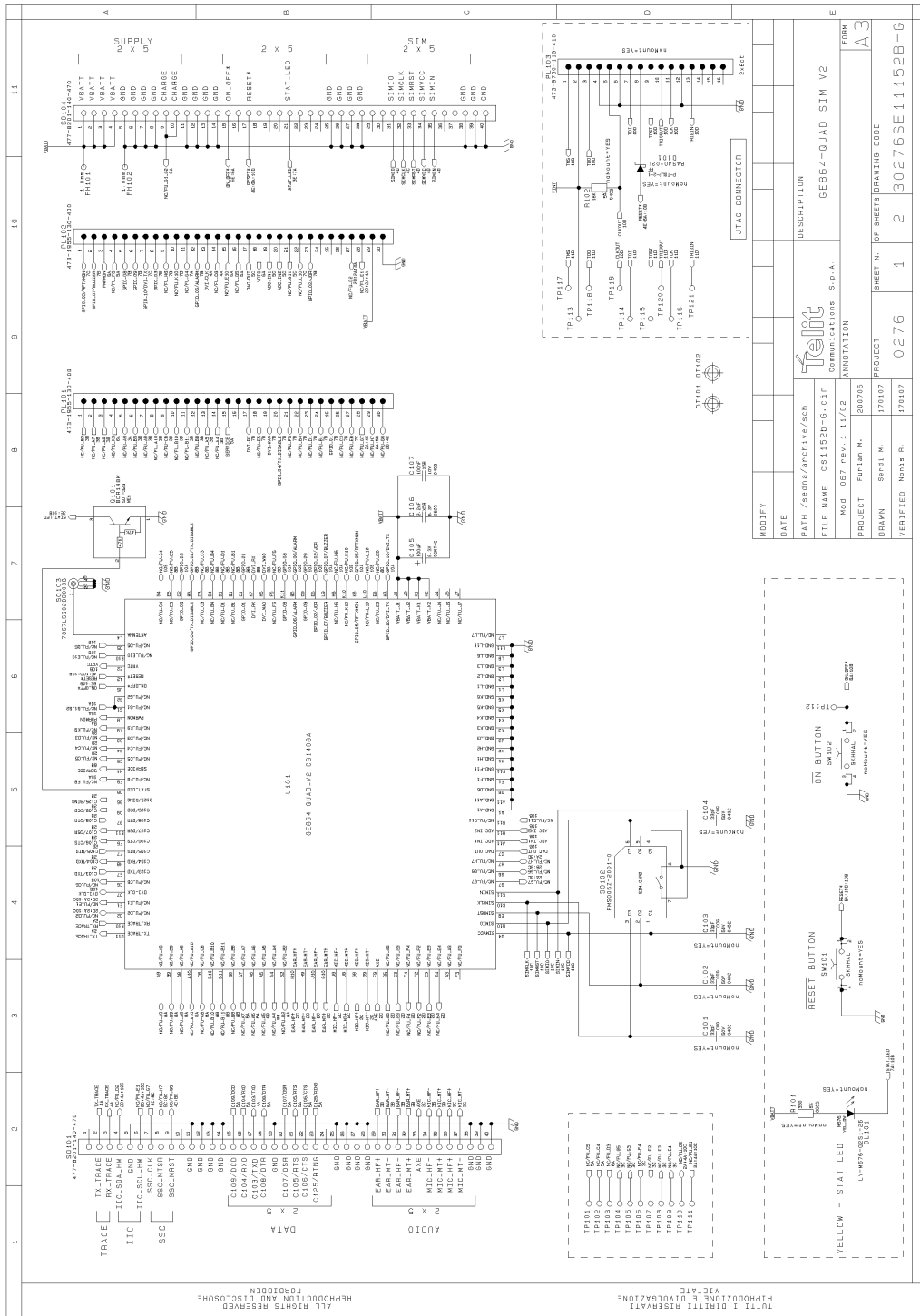

## 44.7. GE864-GPS Interface board

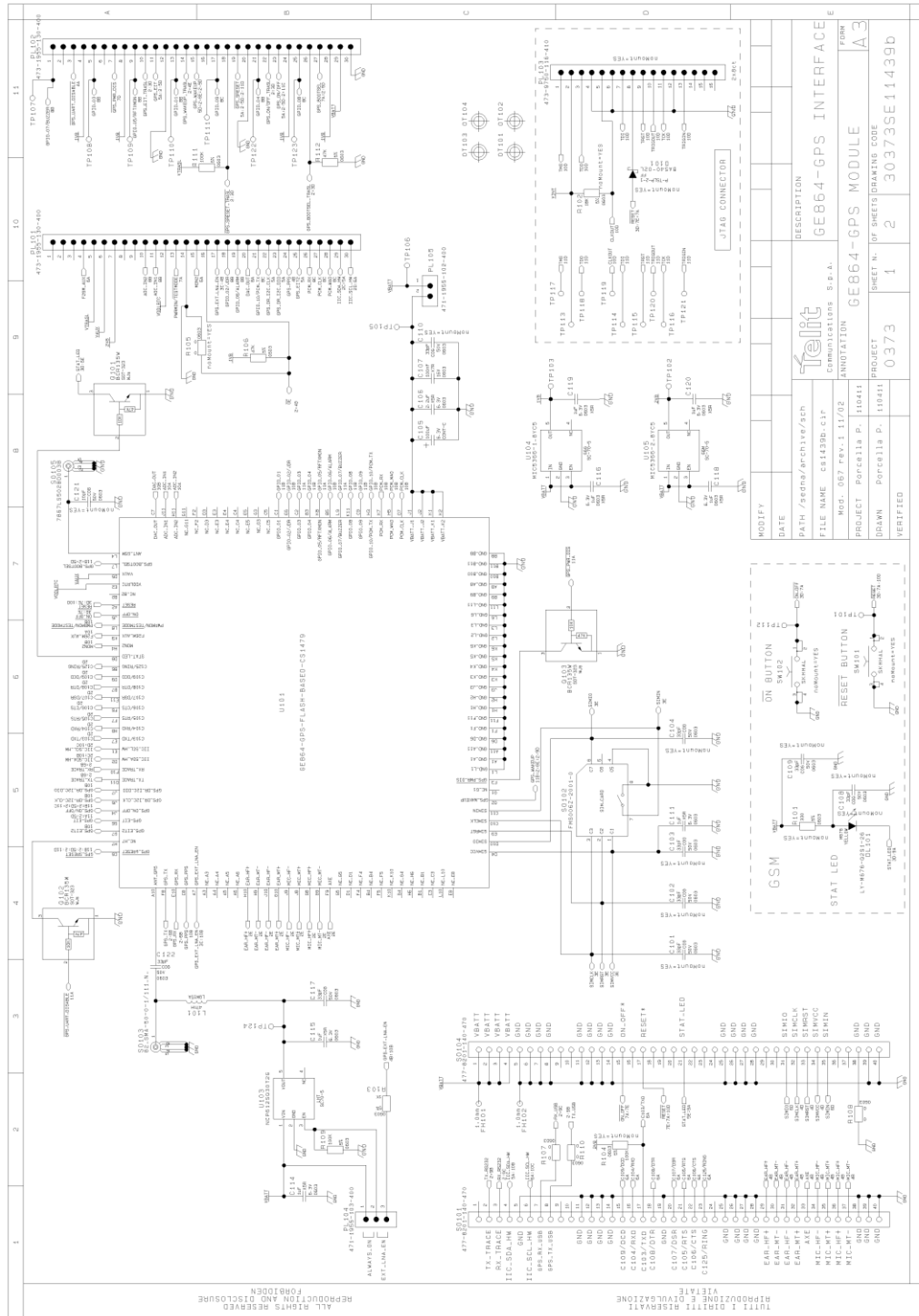

MODIFY	DATE	DESCRIPTION
		GE864-GPS INTERFACE
		COMMUNICATIONS S.p.A.
		ANNO 2013
		PROGETTO
		DISSEGNIATO
		VERIFICATO

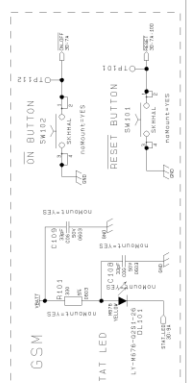

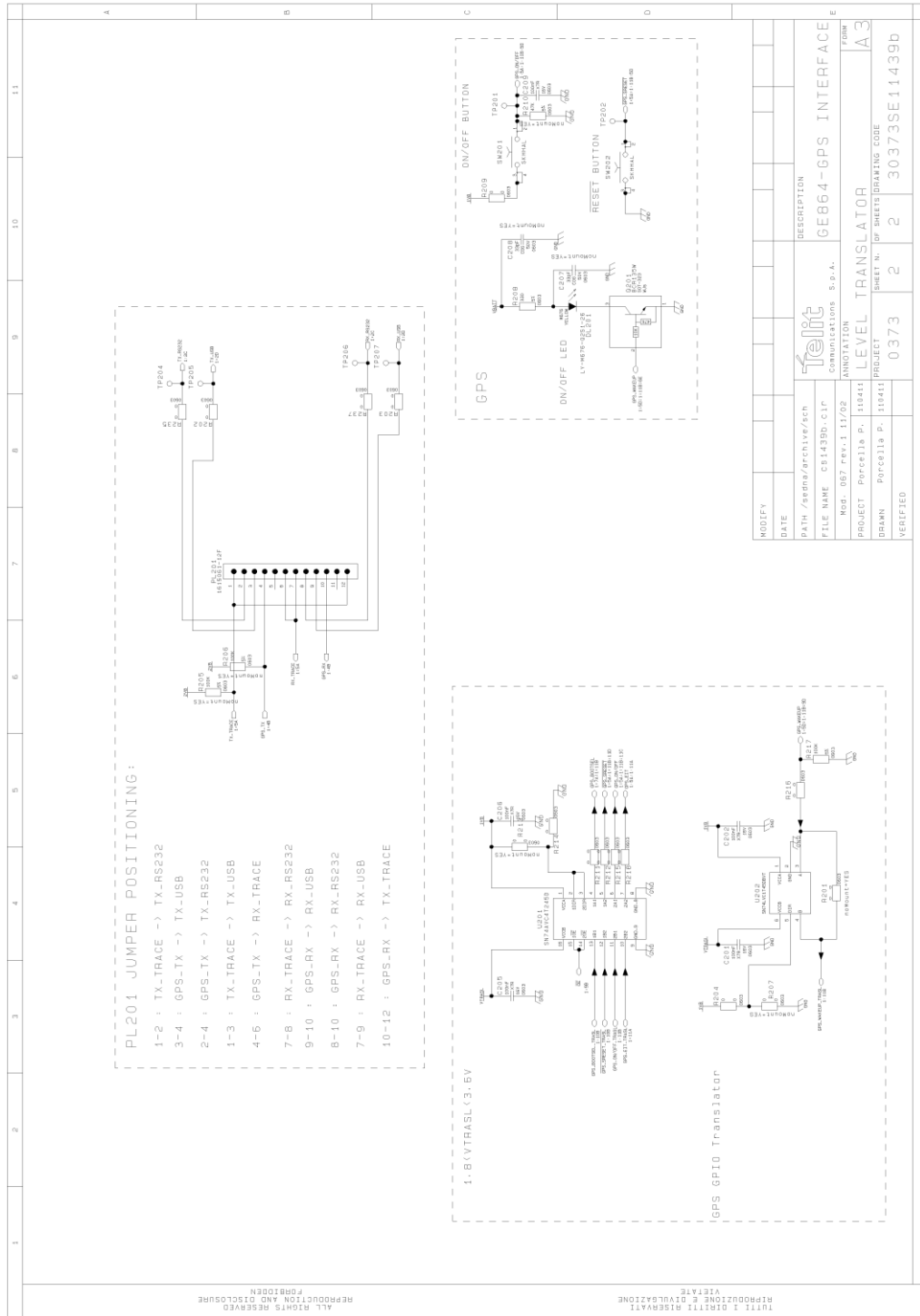

TUTTI I DIRITTI RISERVATI  
REPRODUCTION AND DISCLOSURE  
ALL RIGHTS RESERVED  
REPRODUKTION UND OFFENLEGUNG  
FÖRBIODEN



## 44.8. GE865/SE867-AGPS Interface board

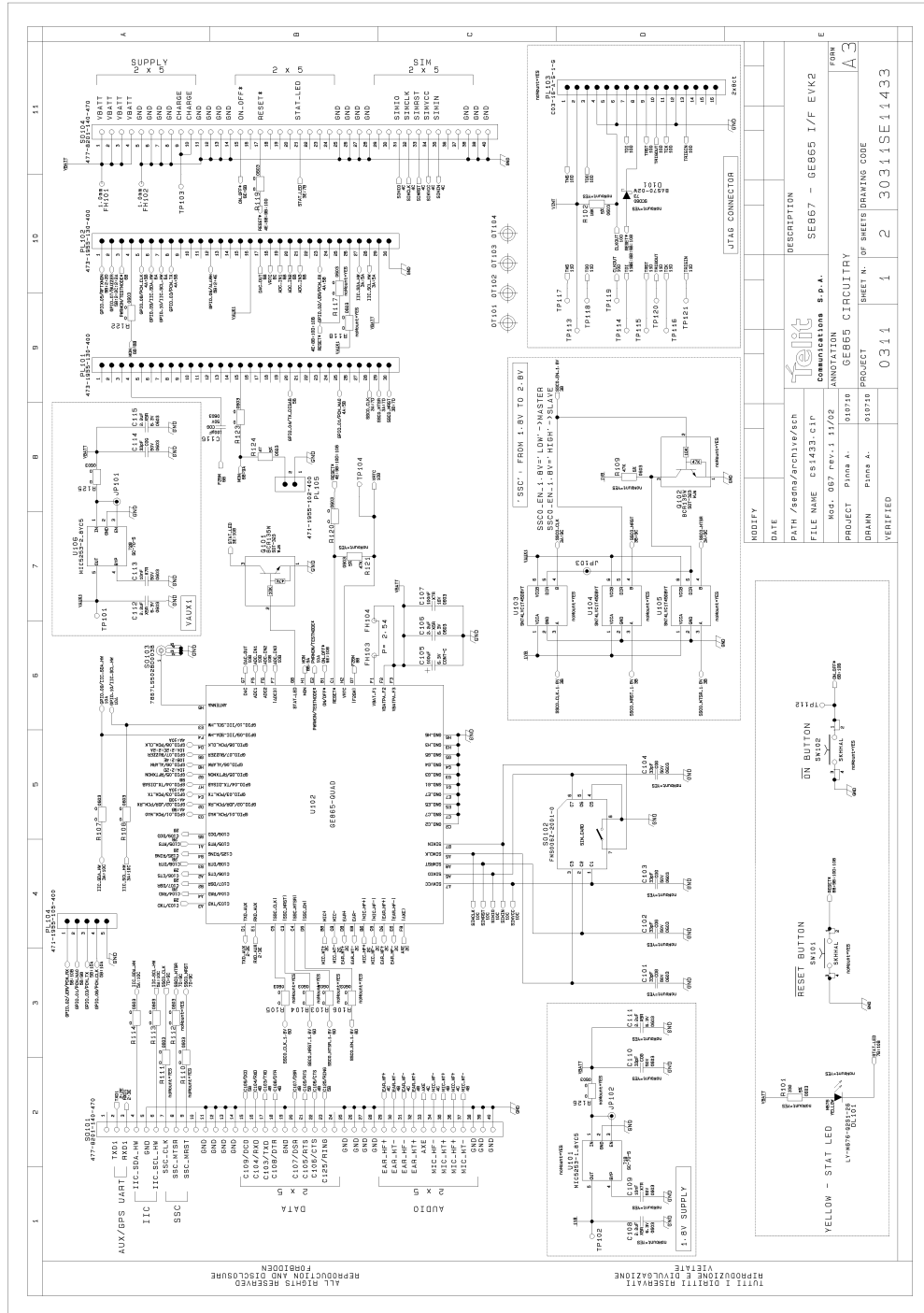

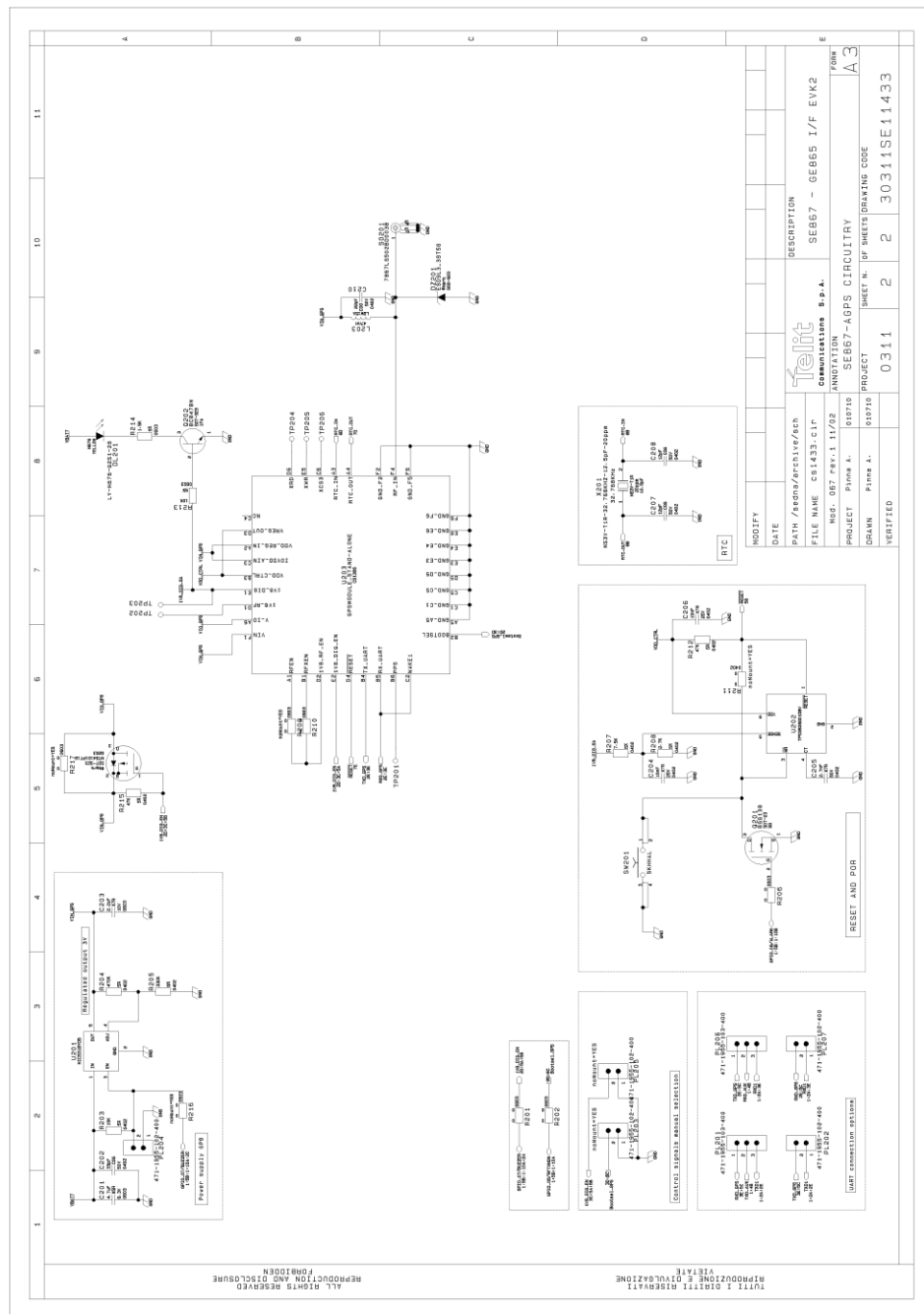



## 44.9. GE865 Interface board

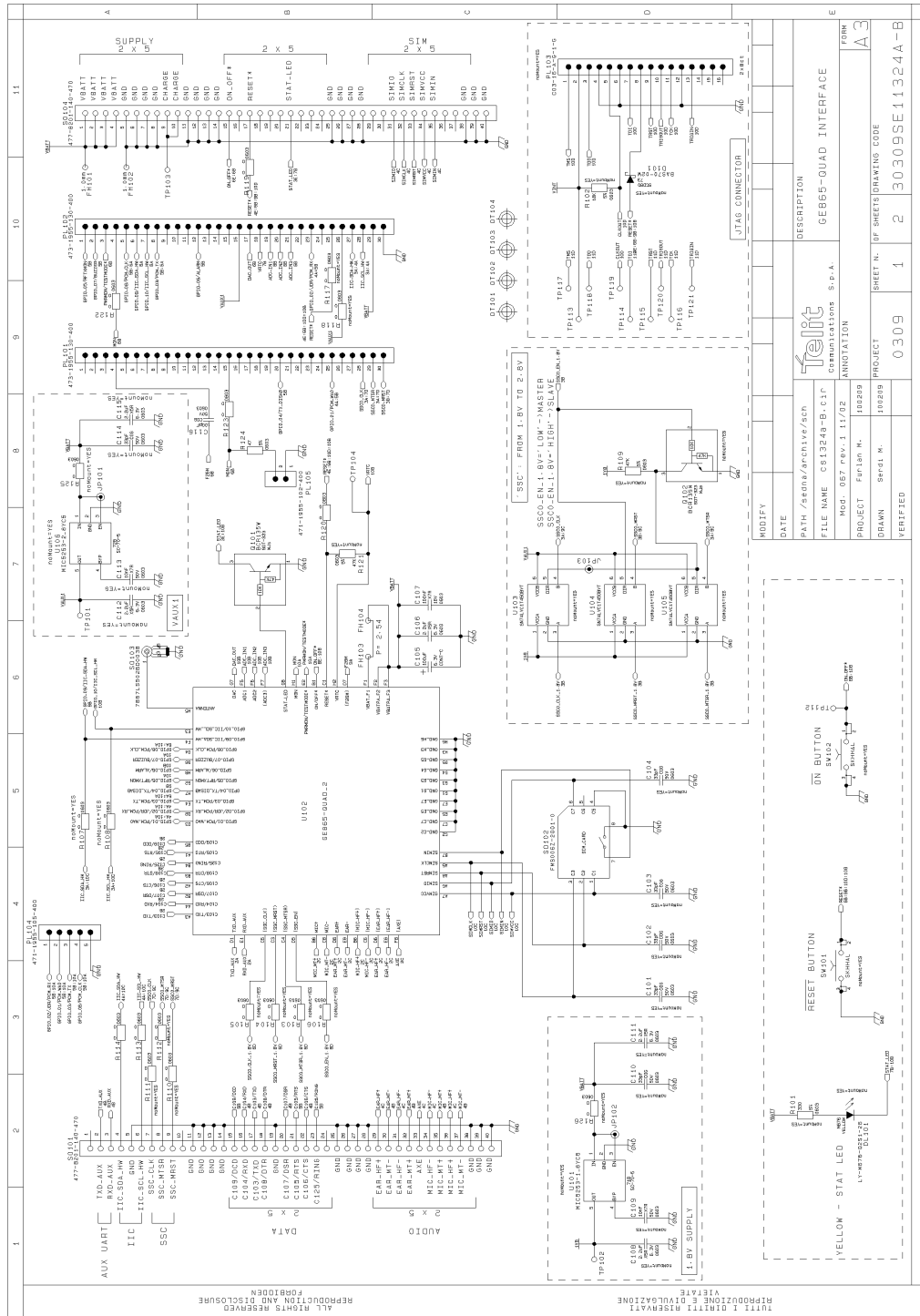

### 44.10. GL865 Interface board

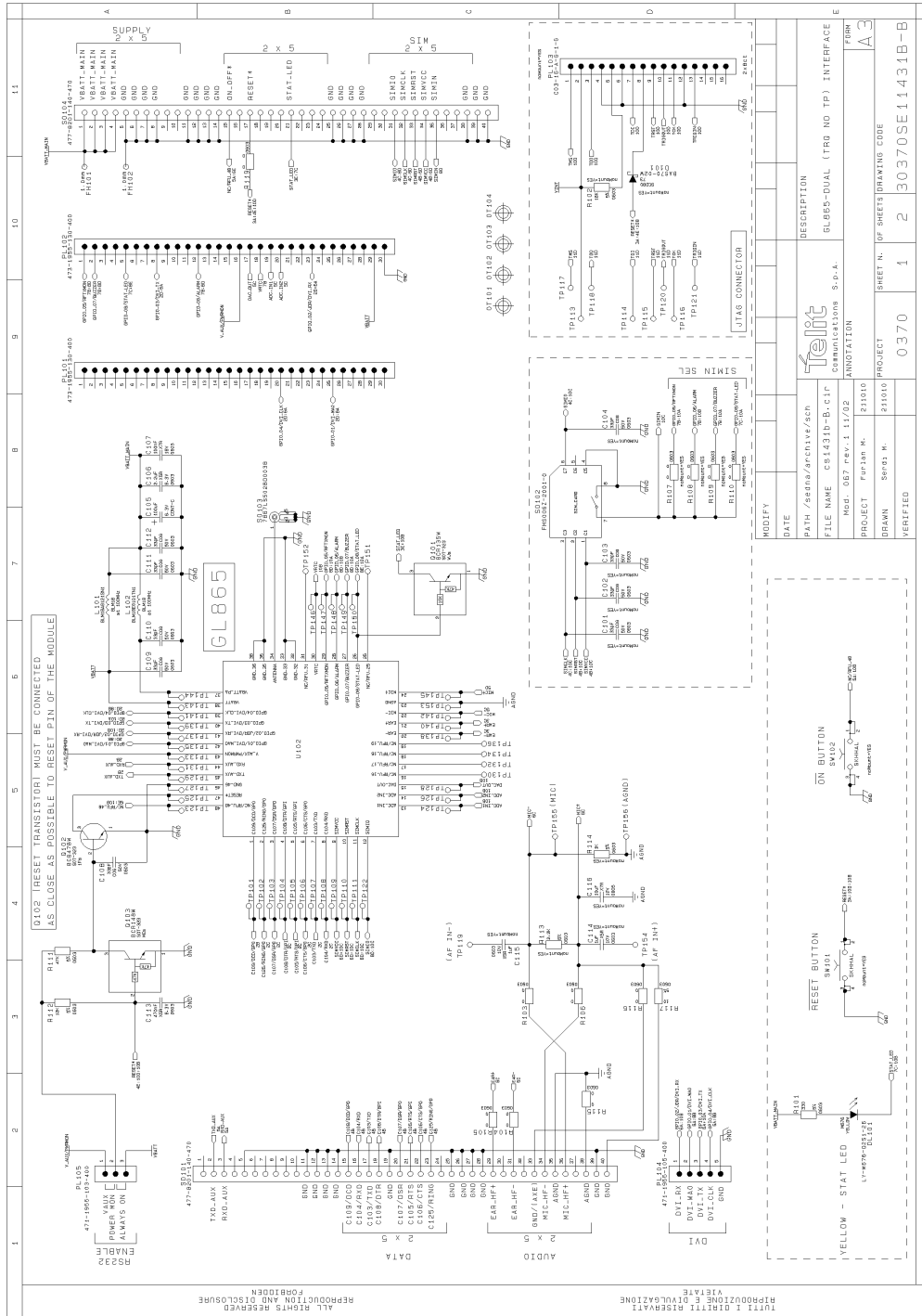

## 44.11. GC864 Interface board

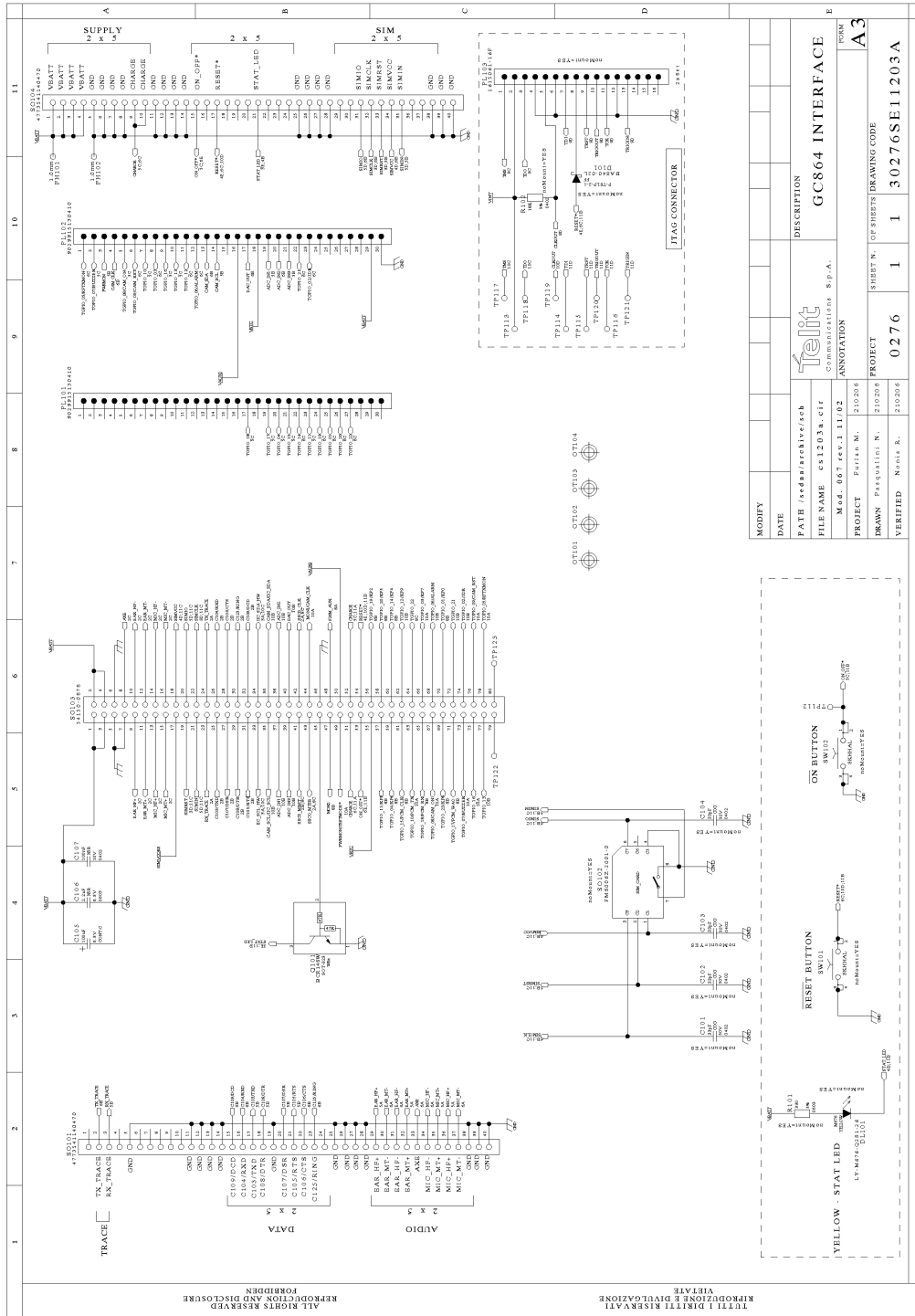

# 44.12. GC864-C2 Interface board

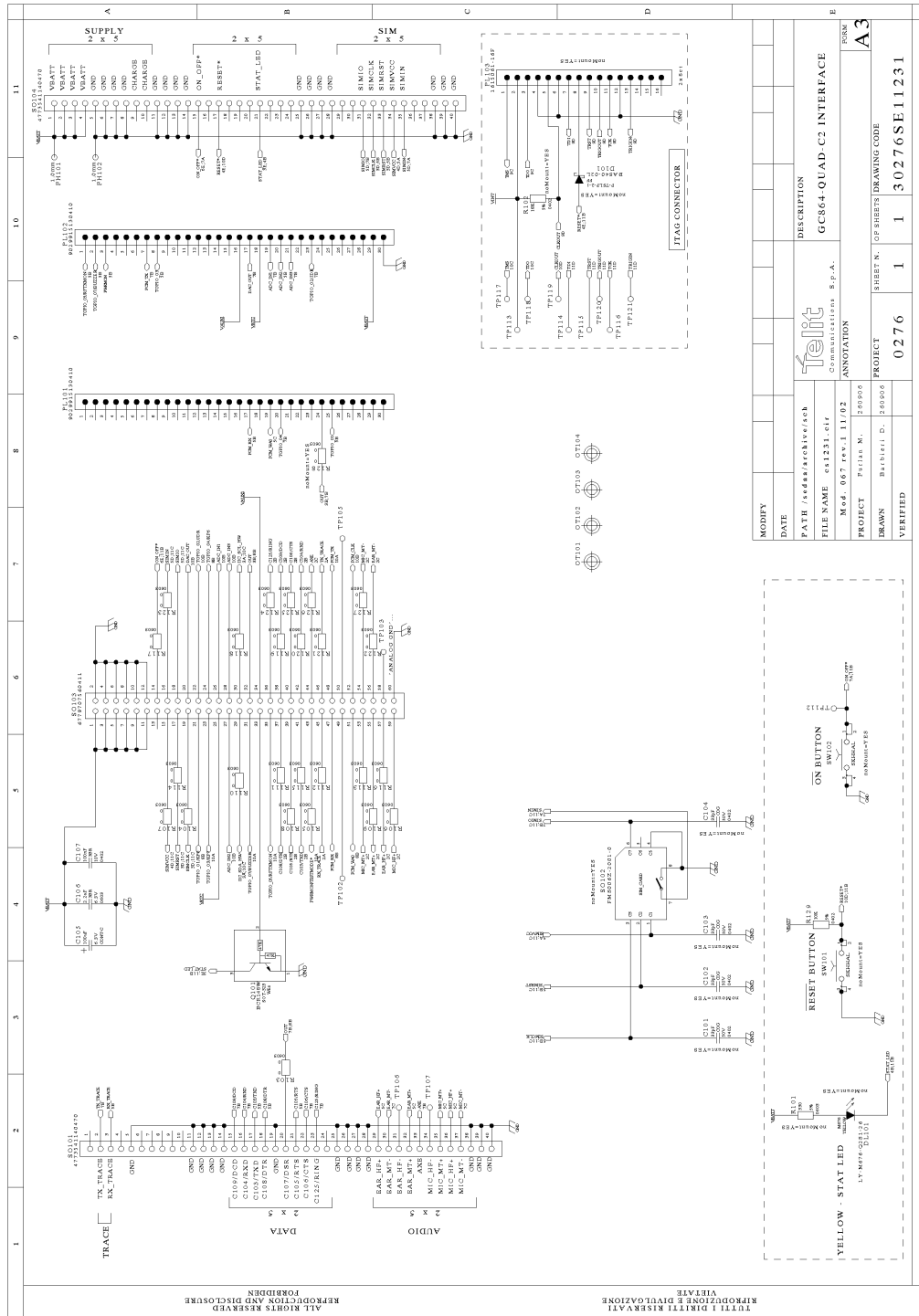

### 44.13. UC864 Interface board

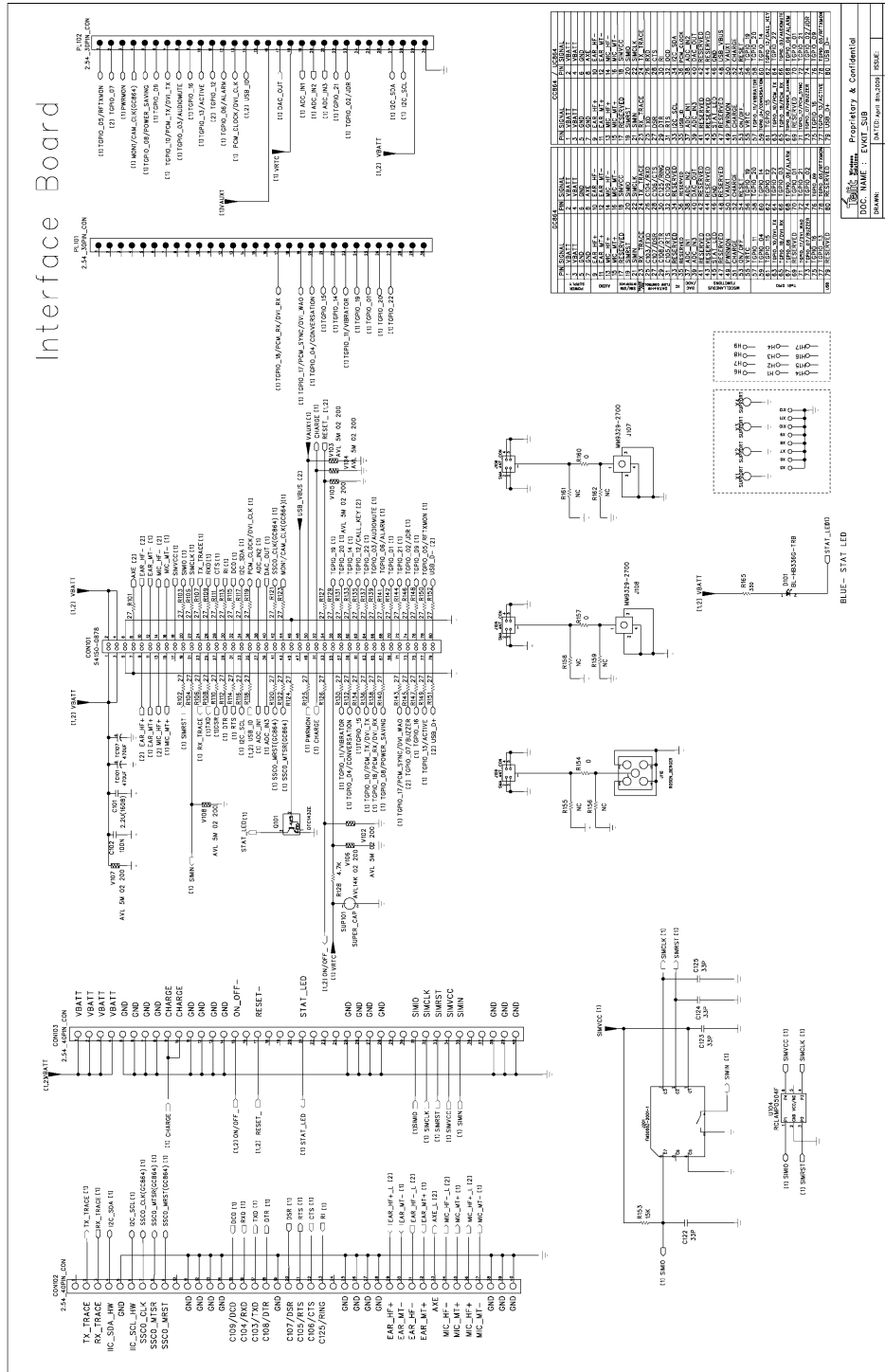



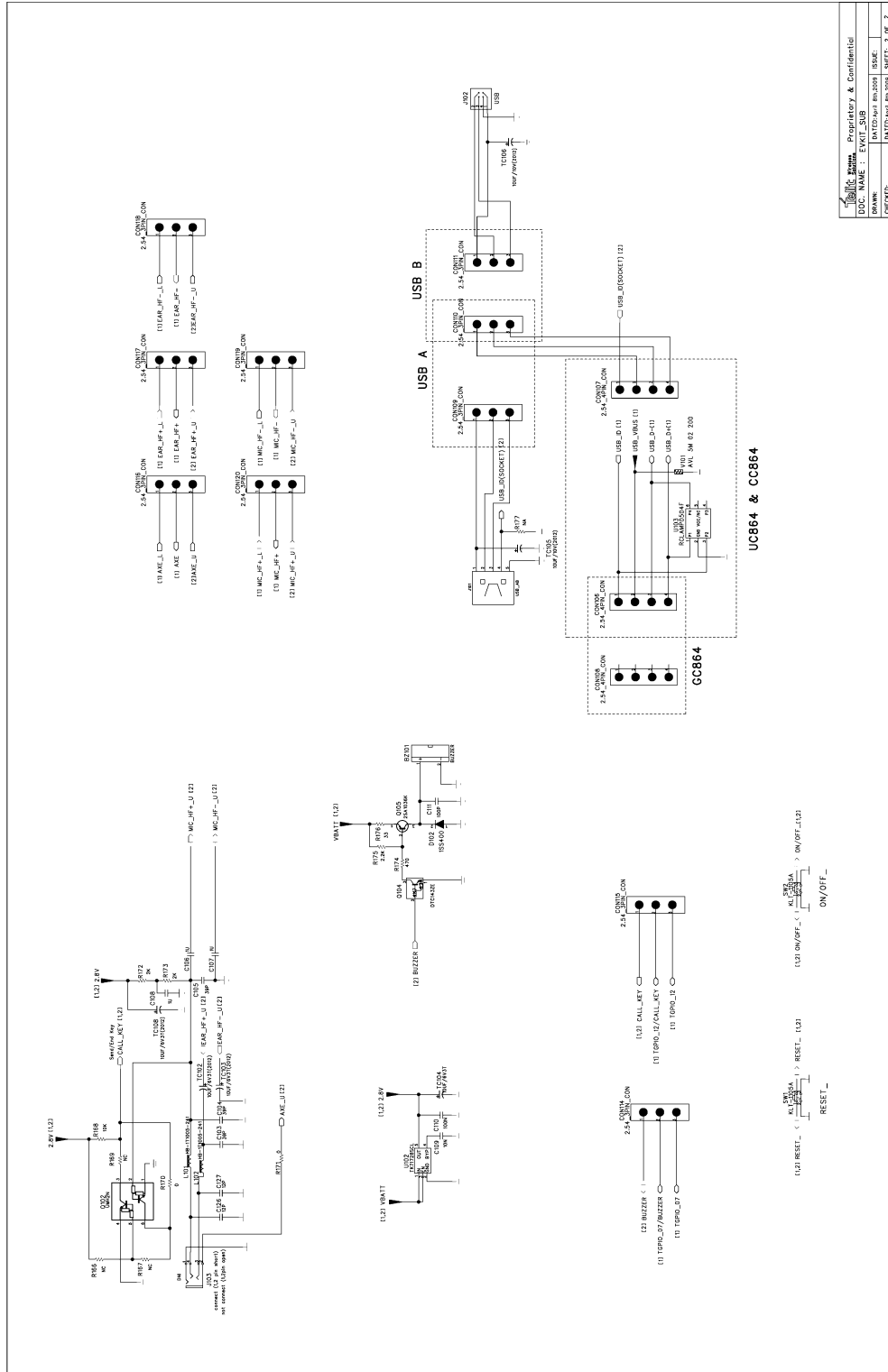

Telit - Proprietary & Confidential			
DOC. NAME :	EVK2_SDB	REV. :	19.0001
DATE :	2015/01/26	RELEASING :	2015/01/26
CHANGED :		DATE :	2015/01/26
		SHEET :	2 OF 2



## 44.14. HE910/UE910 Interface board

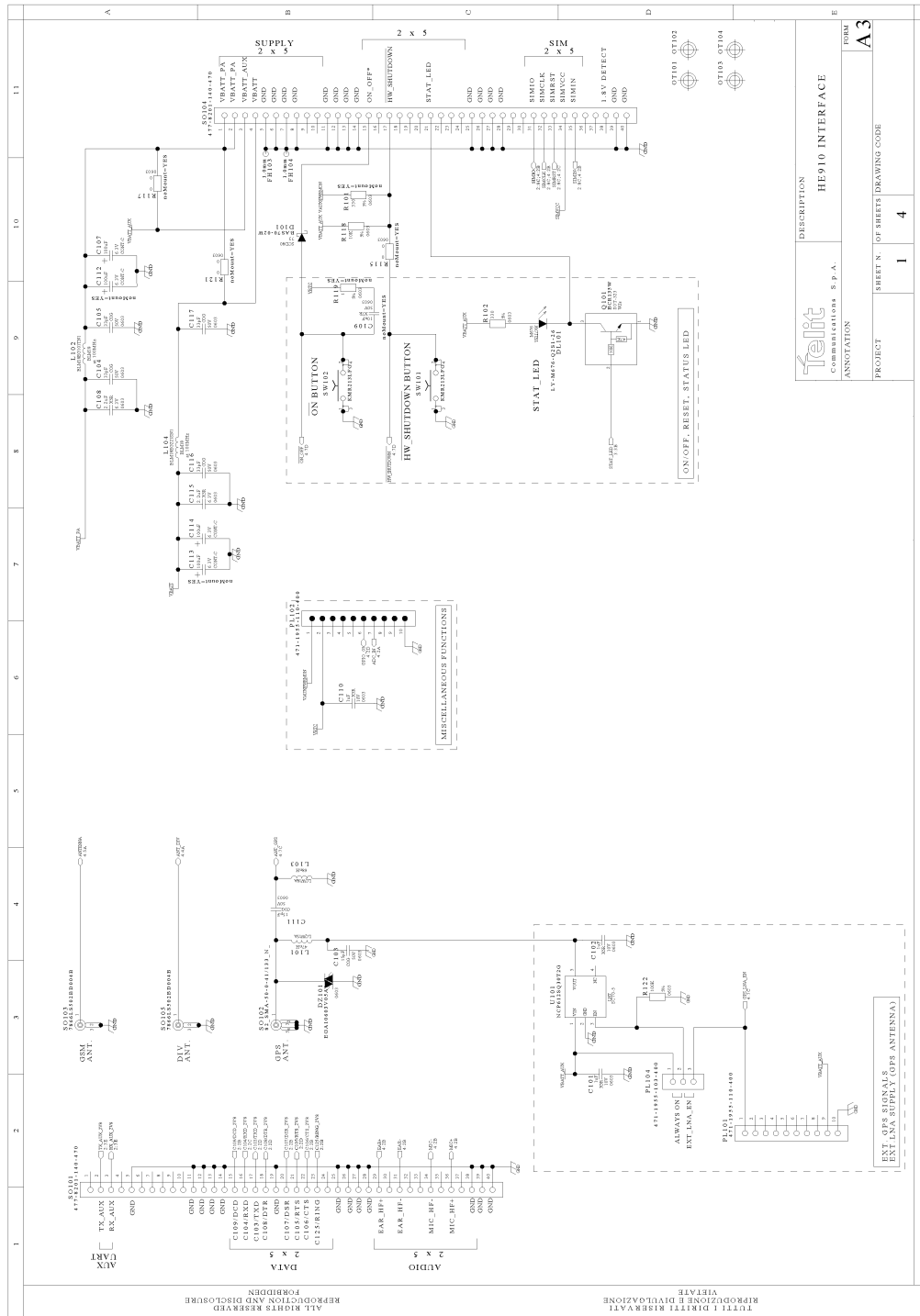

**Telit EVK2 User Guide**  
1w0300704 Rev.19 – 2015/01/26

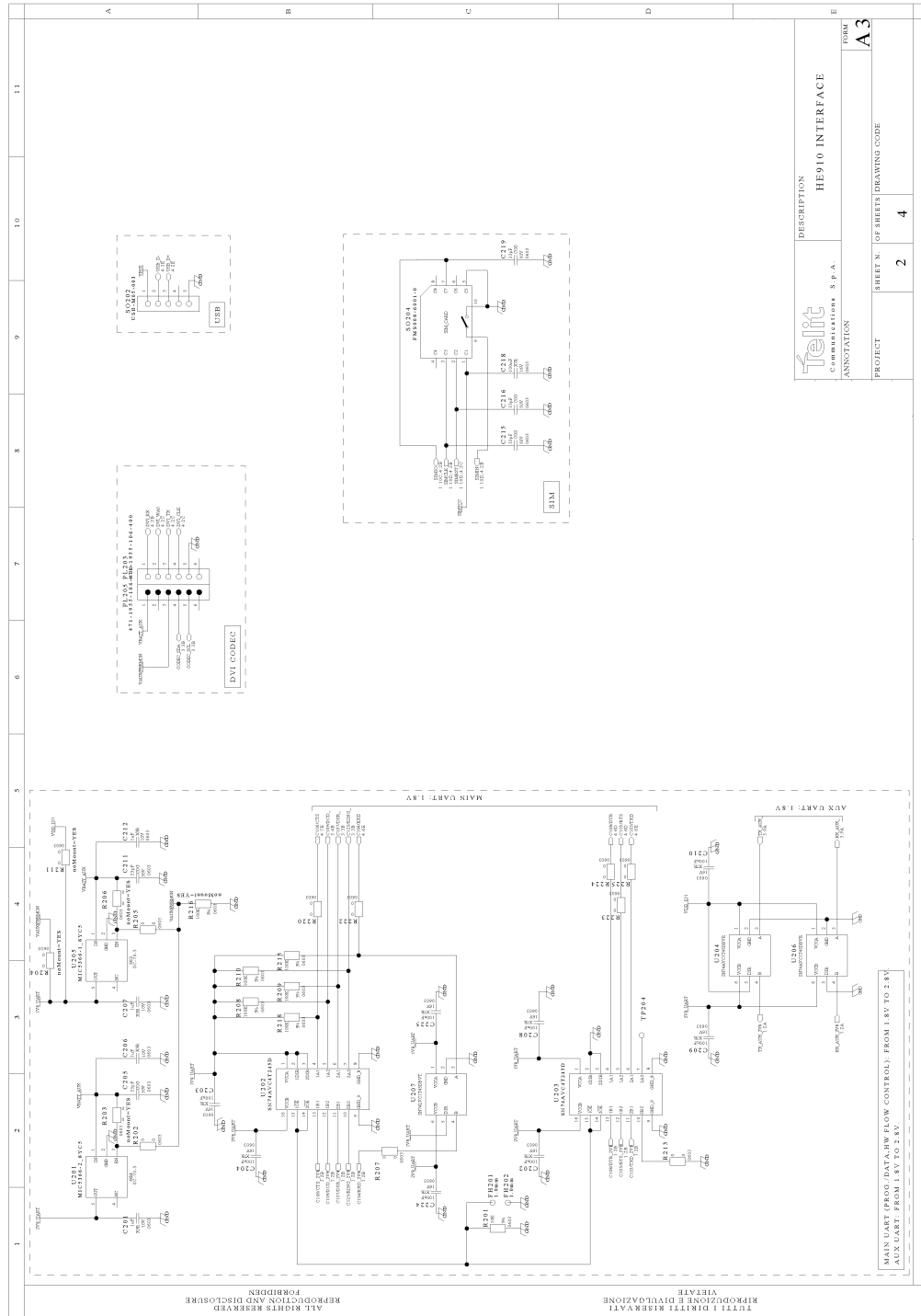

**Telit EVK2 User Guide**  
1w0300704 Rev.19 – 2015/01/26

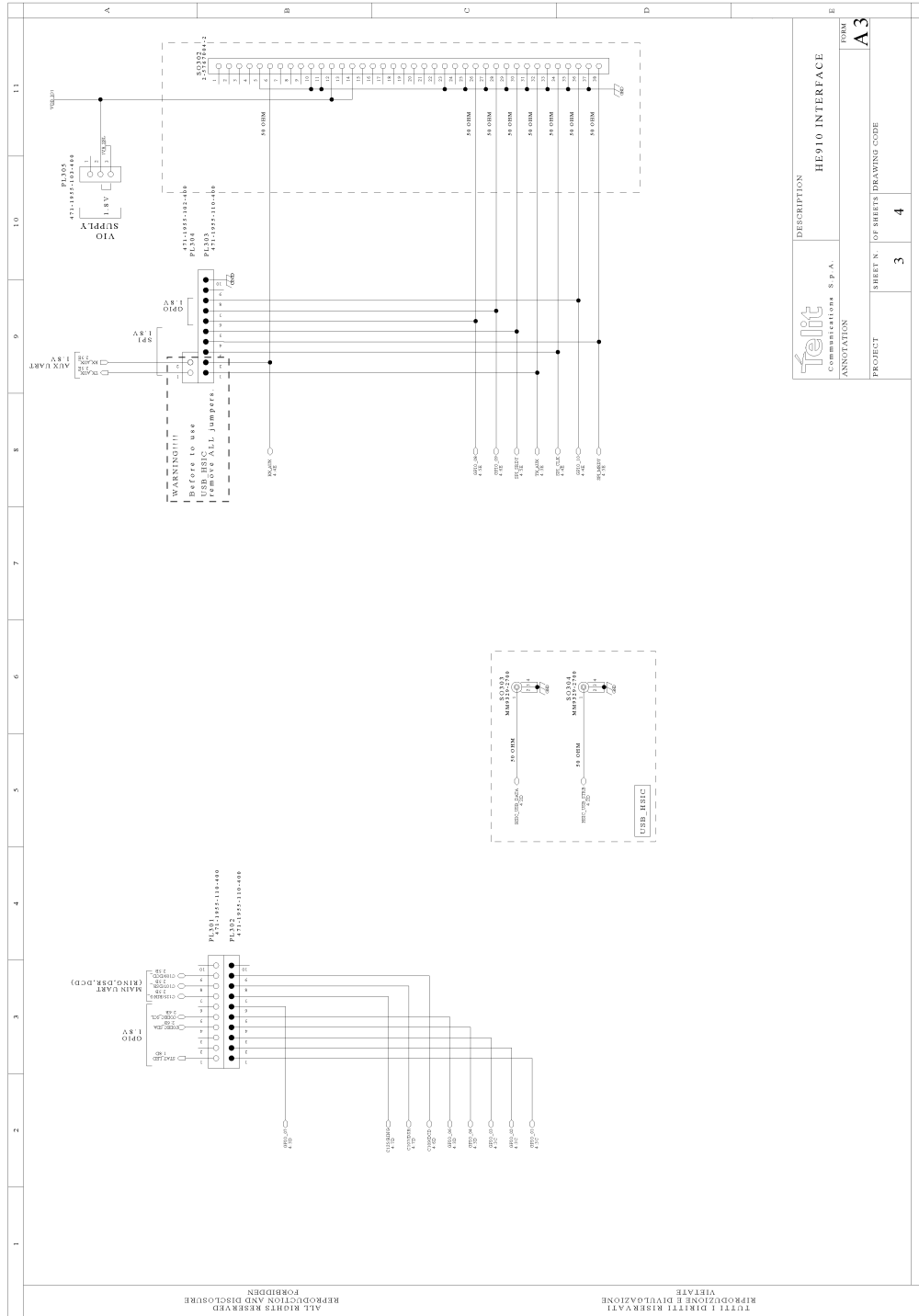

Telit Communications S.p.A. ANNOTATION	DESCRIPTION	HE910 INTERFACE
	FORM	A3
PROJECT	SHEET N.	OF SHEETS DRAWING CODE
	3	4

TUTTI I DIRITTI RISERVATI  
RIPRODUZIONE E DIVULGAZIONE  
VIETATE  
ALL RIGHTS RESERVED  
REPRODUCTION AND DISCLOSURE  
FORBIDDEN



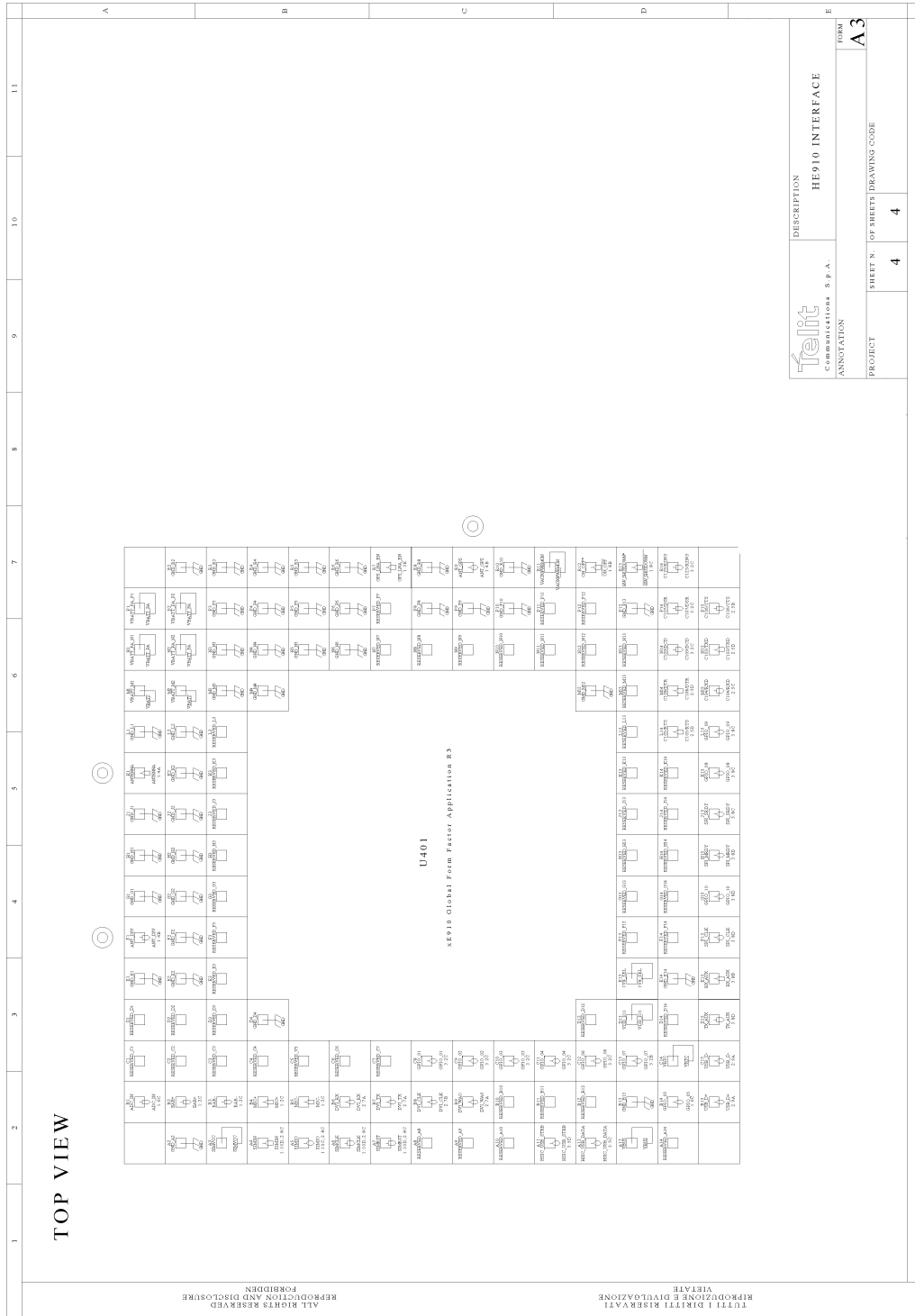



## 44.15. GE910 Interface board

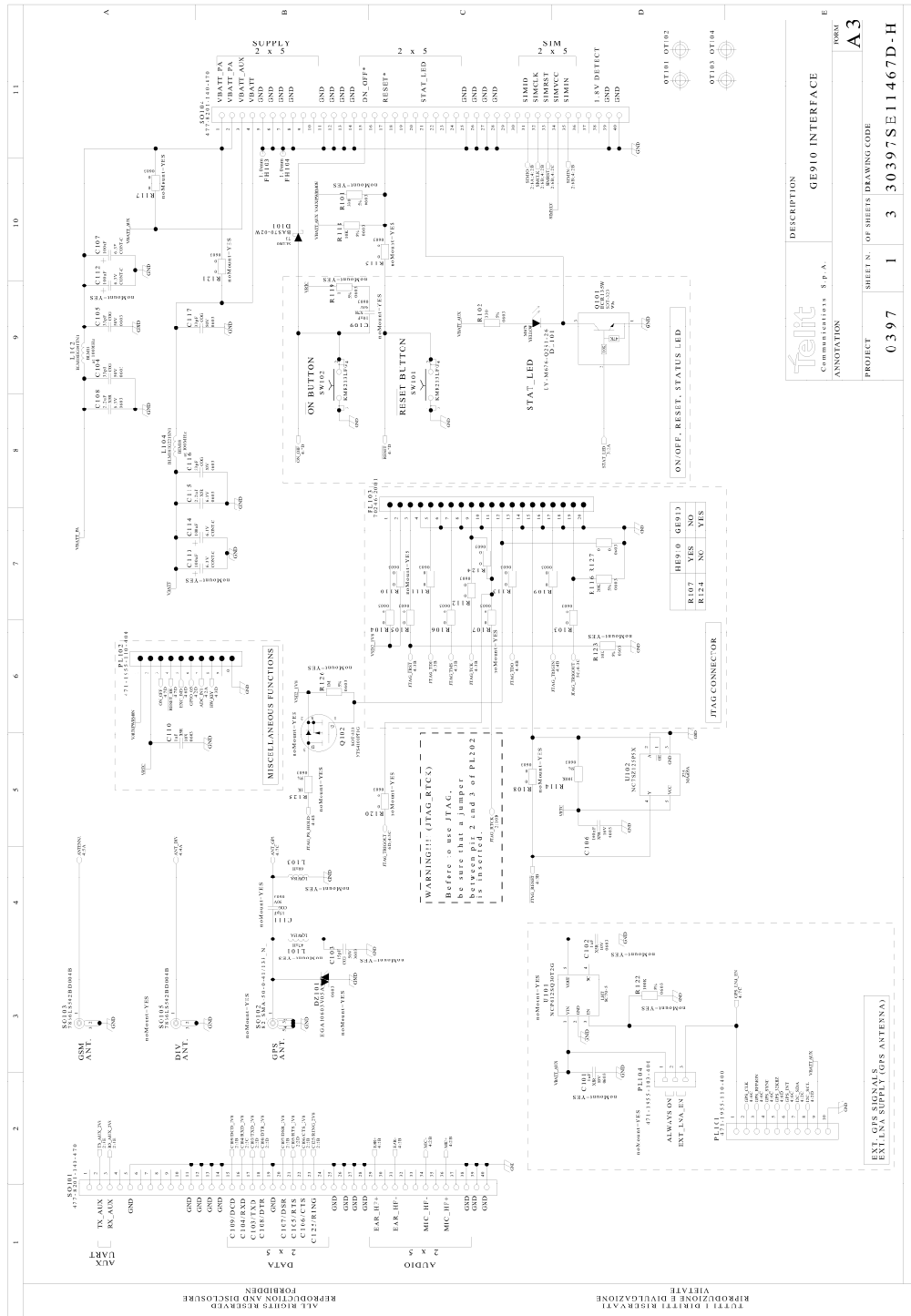

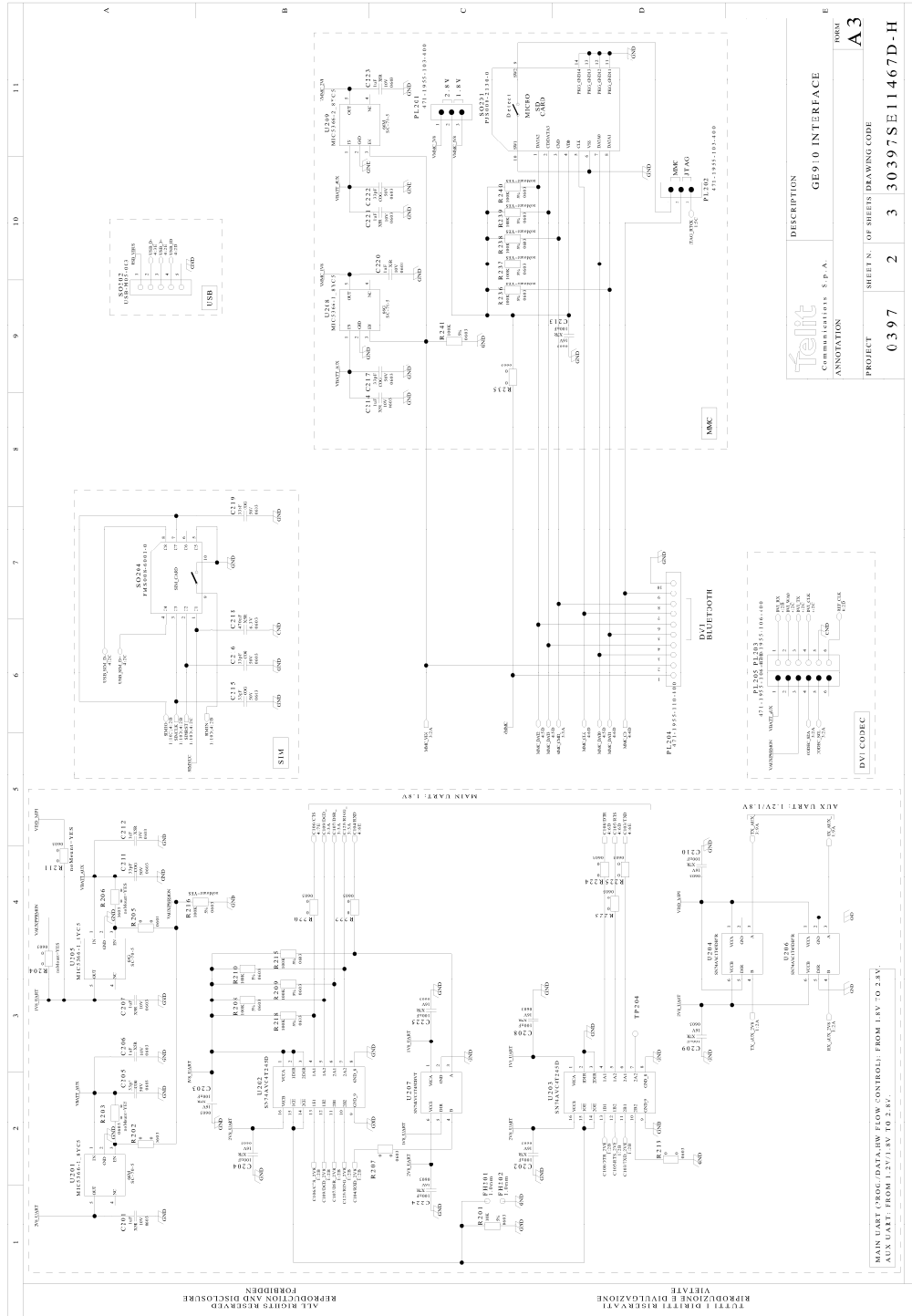

DESCRIPTION		FORM	
GE910 INTERFACE		A3	
COMMUNICATIONS S.p.A.		REVISION	
PROJECT	SHEET N.	OF SHEETS	DRAWING CODE
0397	2	3	30397SE11467D-H
ANNOTATION			



# Telit EVK2 User Guide

1w0300704 Rev.19 – 2015/01/26

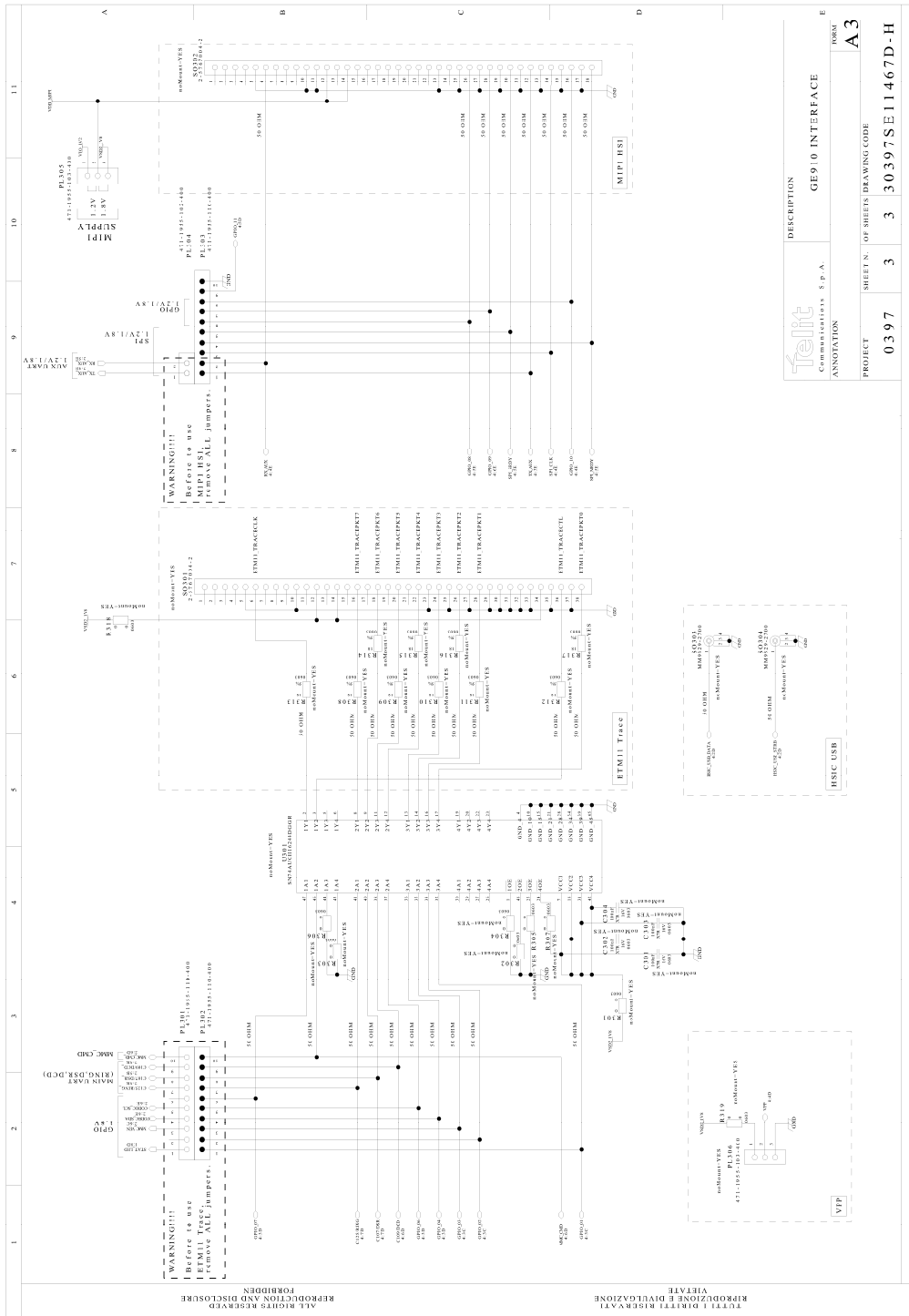

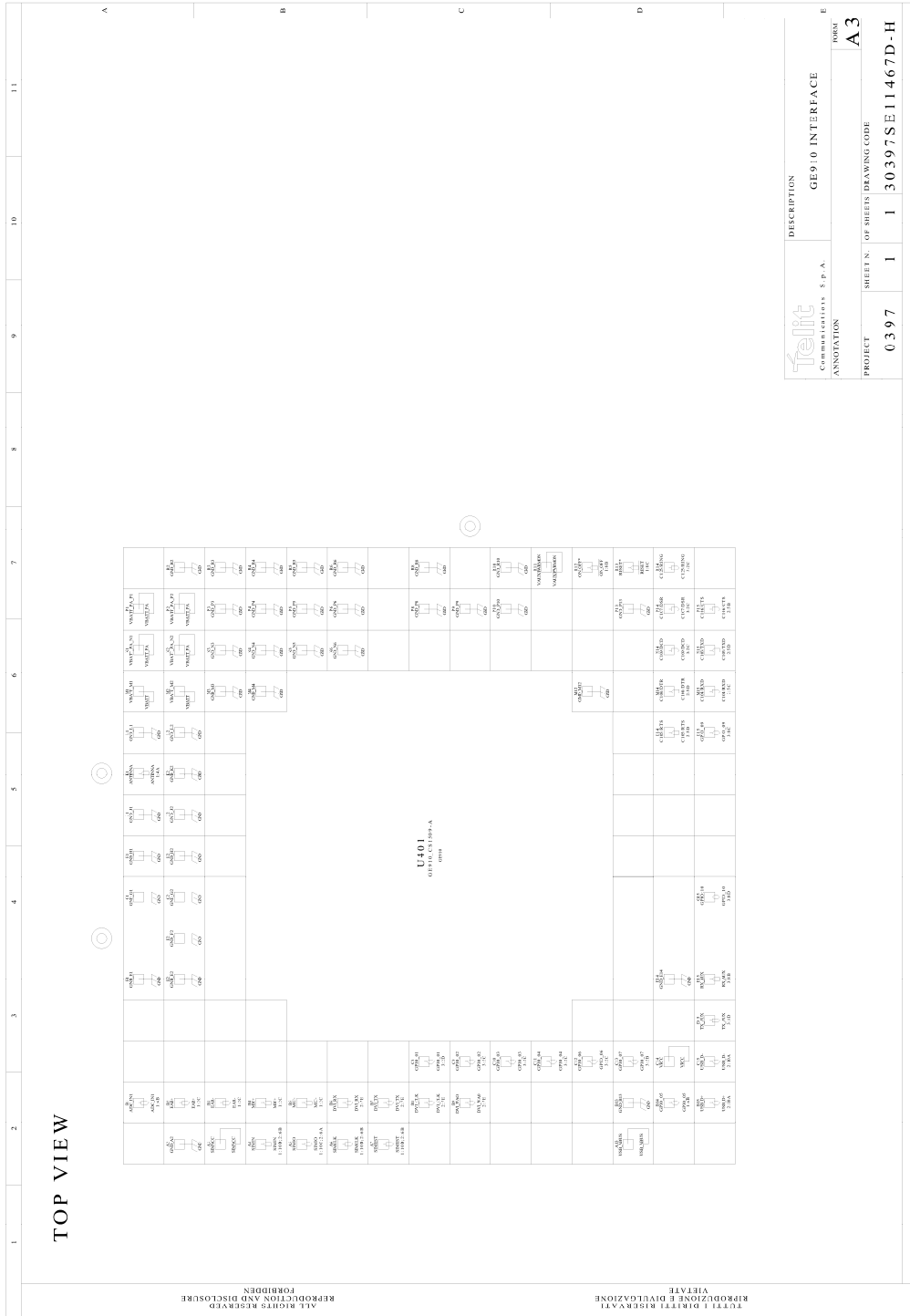

 COMMUNICATIONS S.p.A.	DESCRIPTION	GE910 INTERFACE	FORM
	ANNOTATION		A3
PROJECT	SHEET N.	OF SHEETS	DRAWING CODE
0397	1	1	30397SE11467D-H



# 44.16. GE910-GNSS Interface board

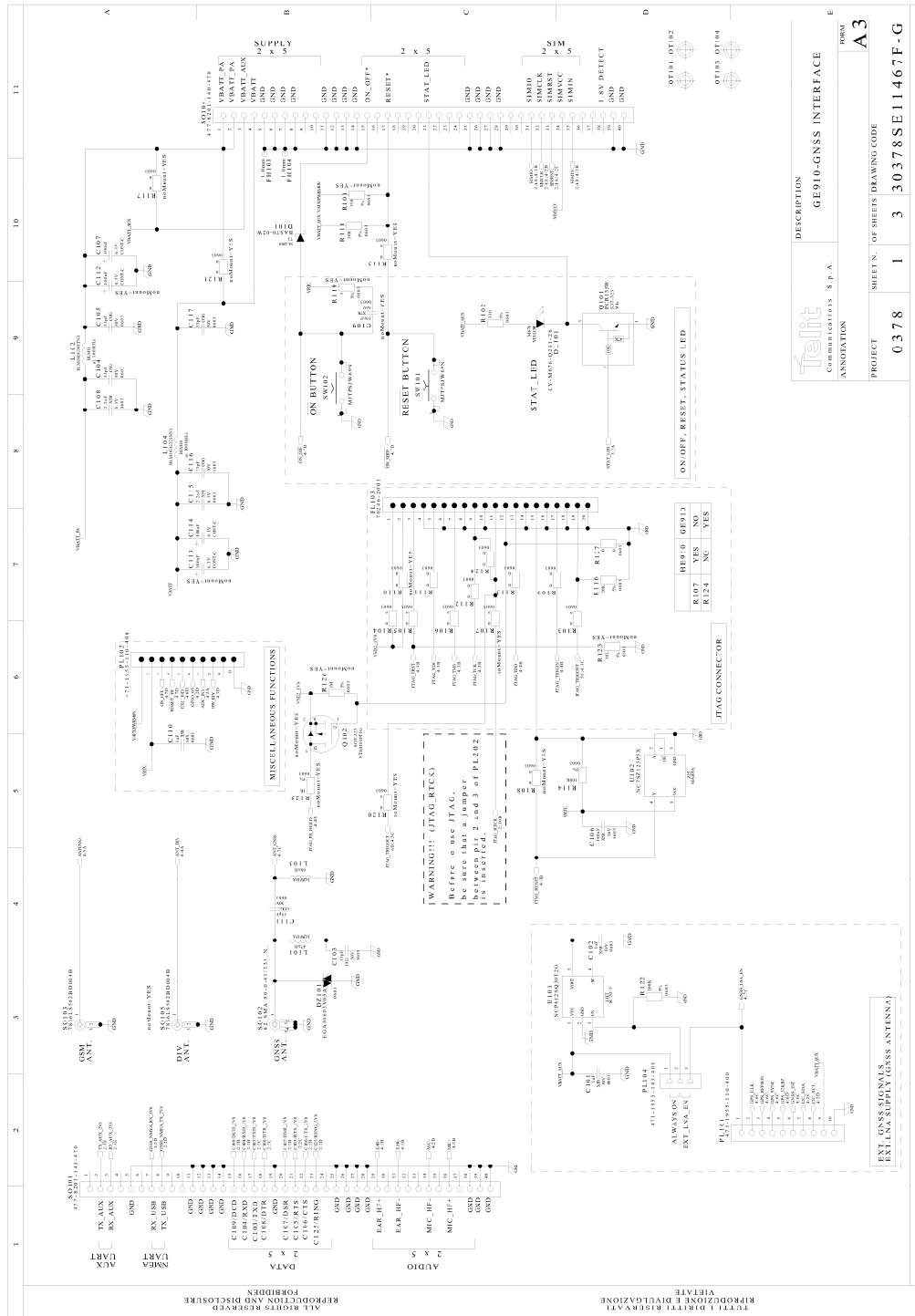



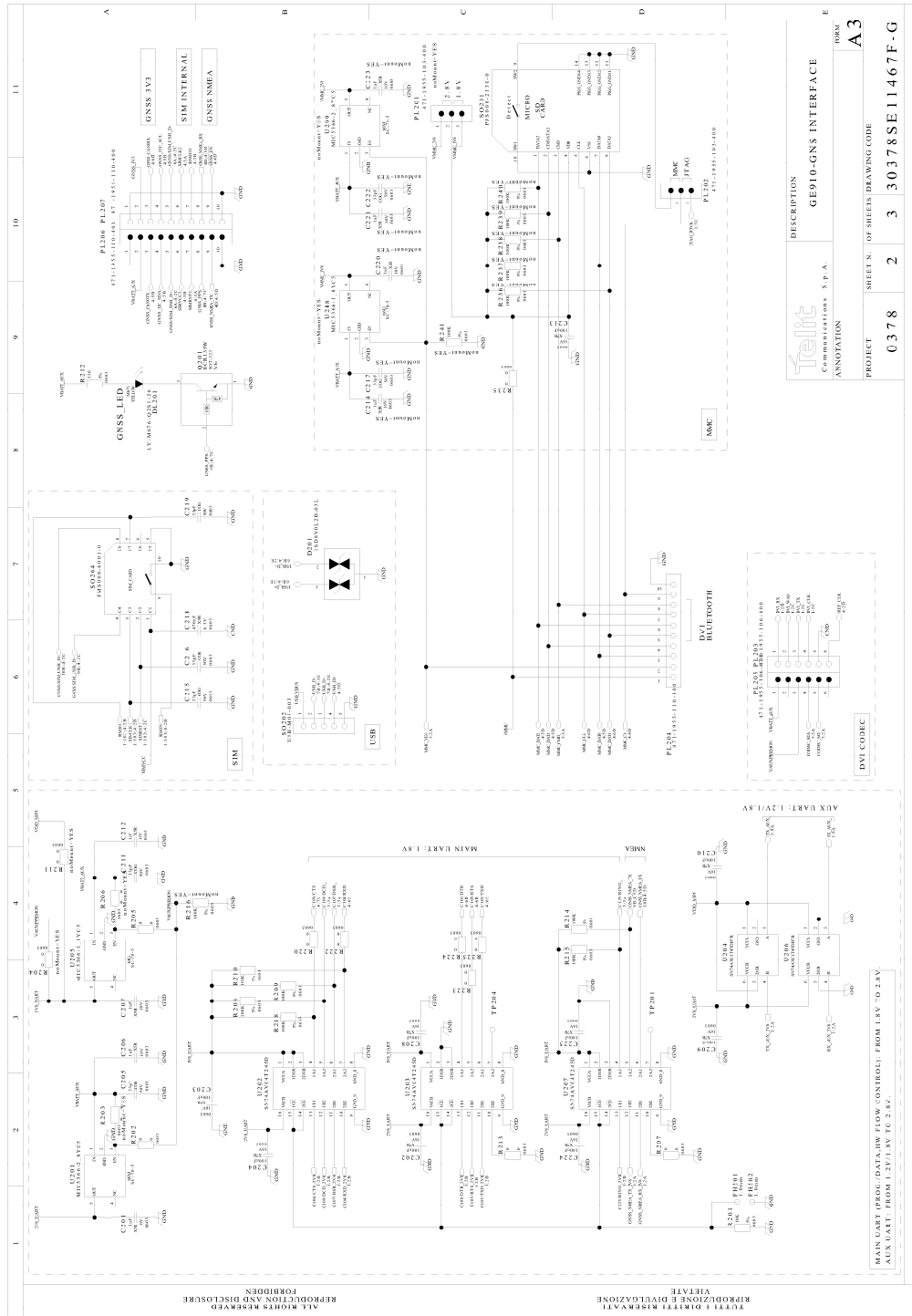

DESCRIPTION	GE910-GNS INTERFACE
PROJECT	0378
SHEET N.	2
OF SHEETS	3
DRAWING CODE	30378SE11467F-G
REVISION	A3



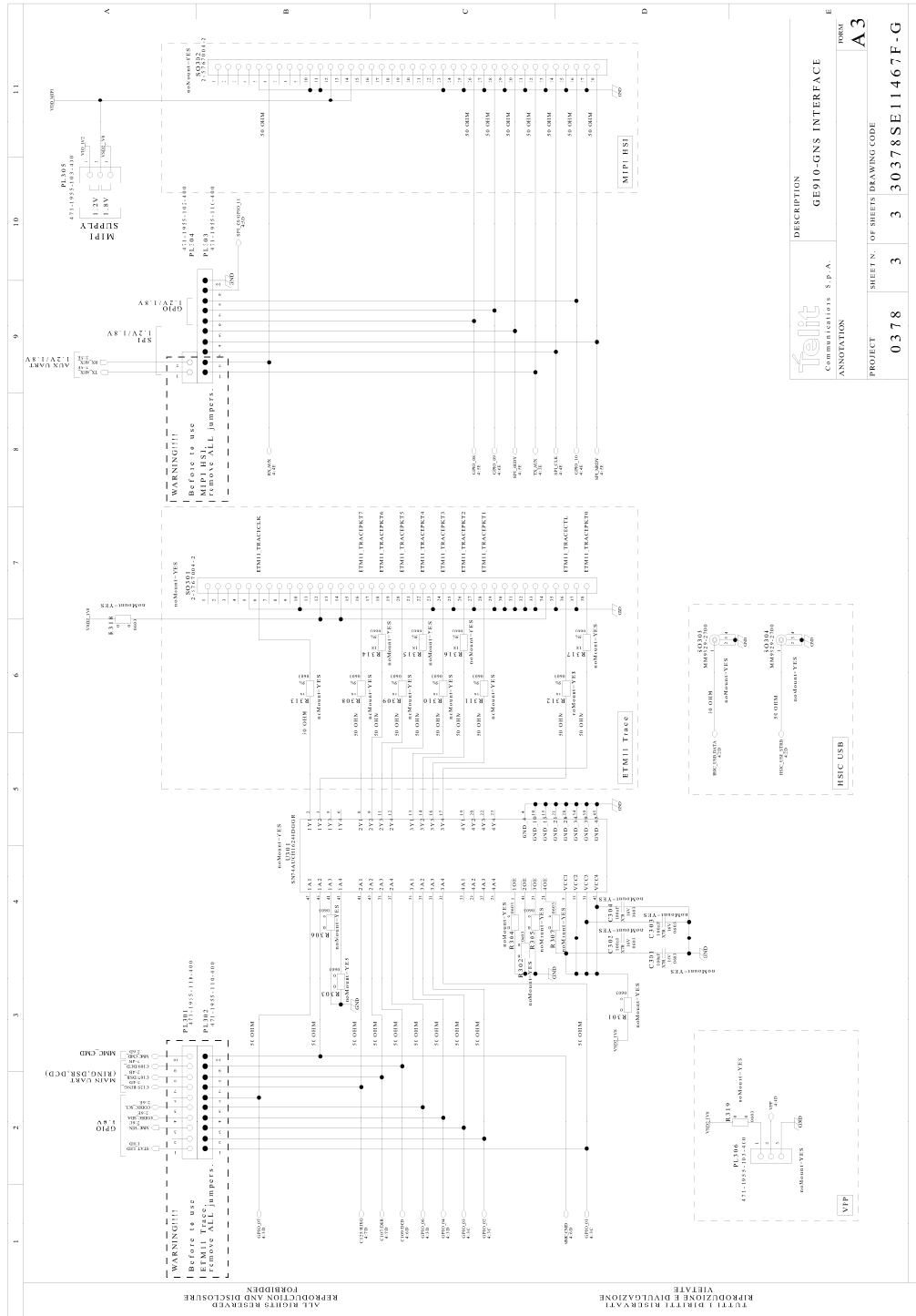

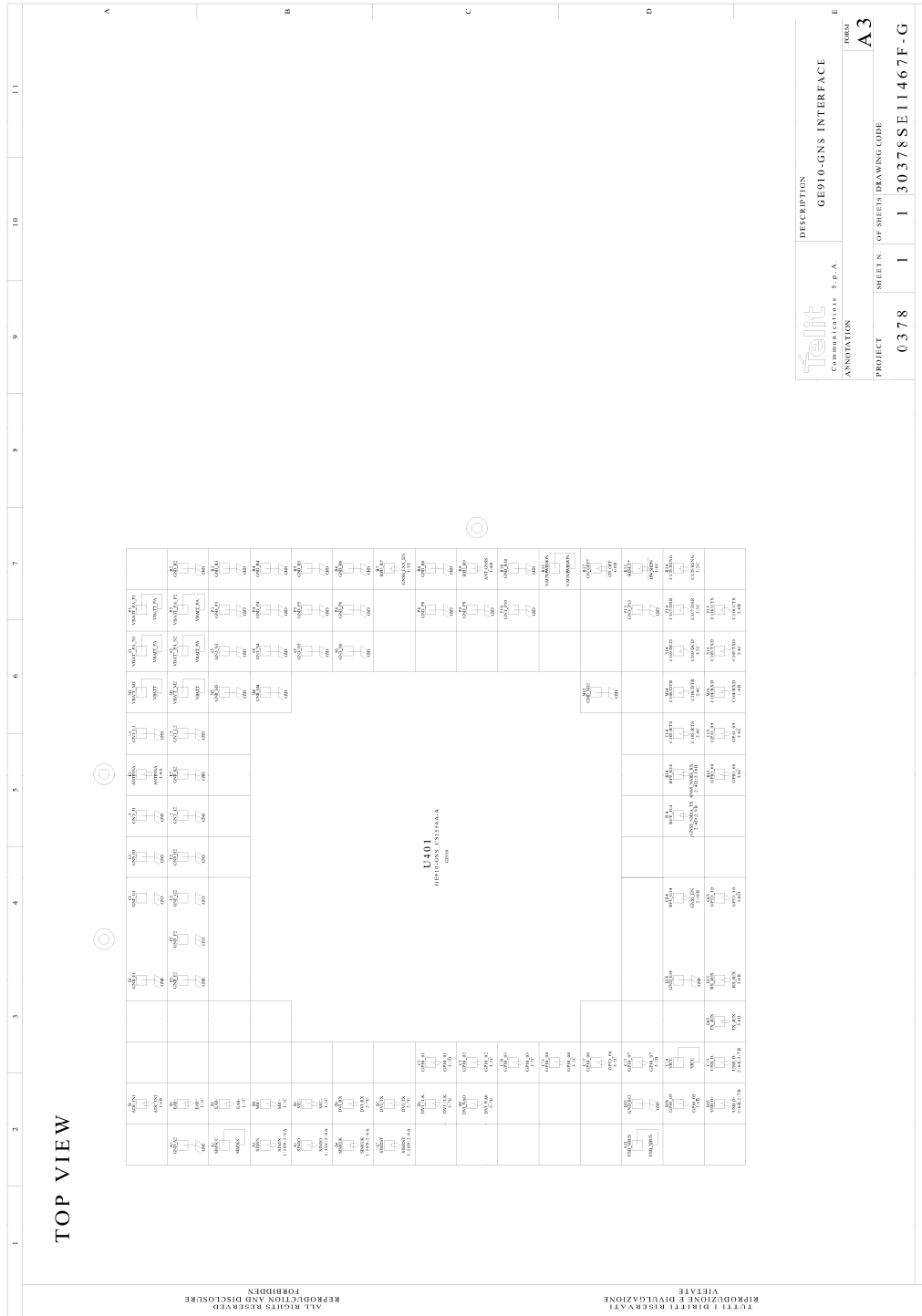

# 44.17. GE910-QUAD V3 Interface board

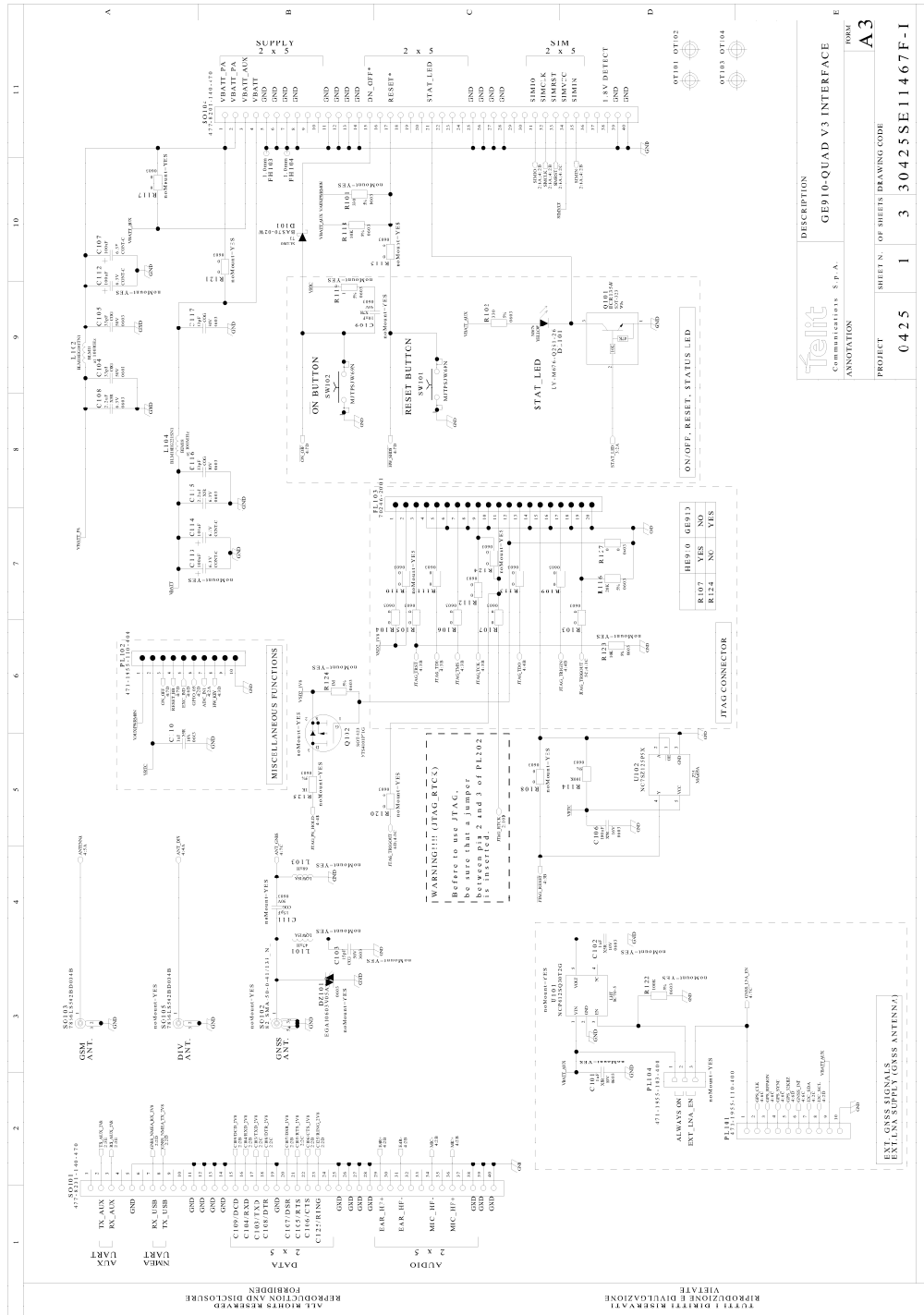

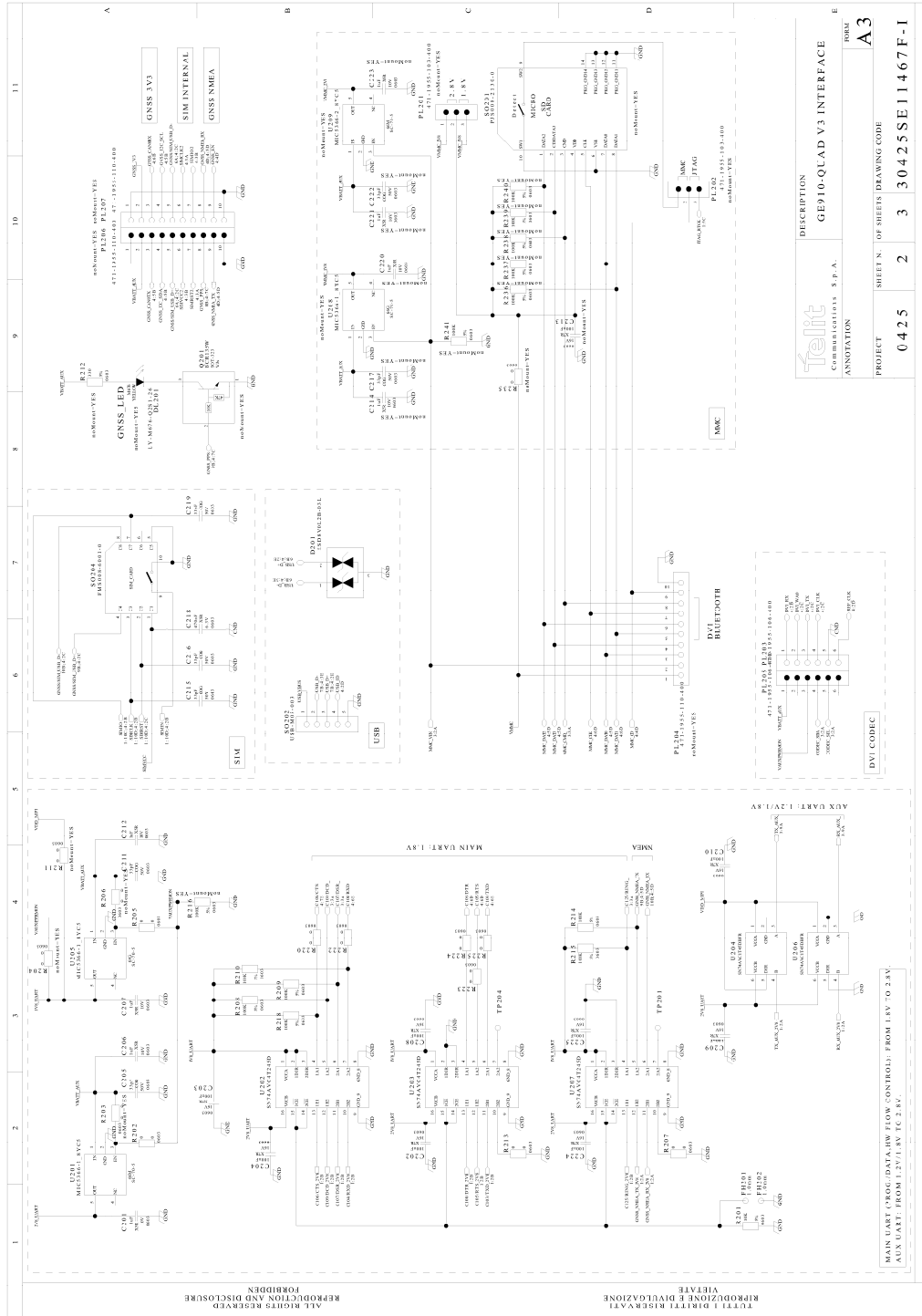



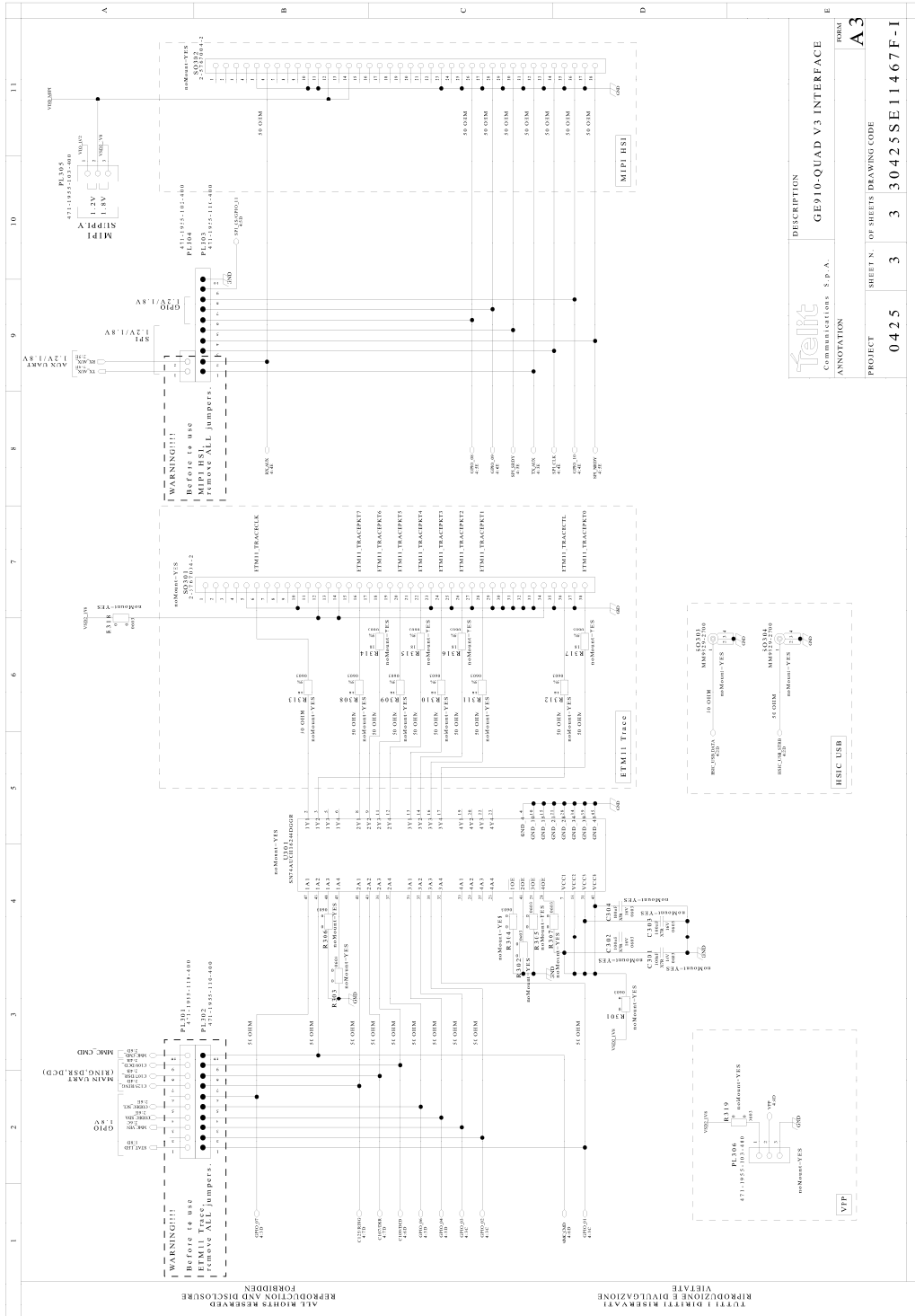

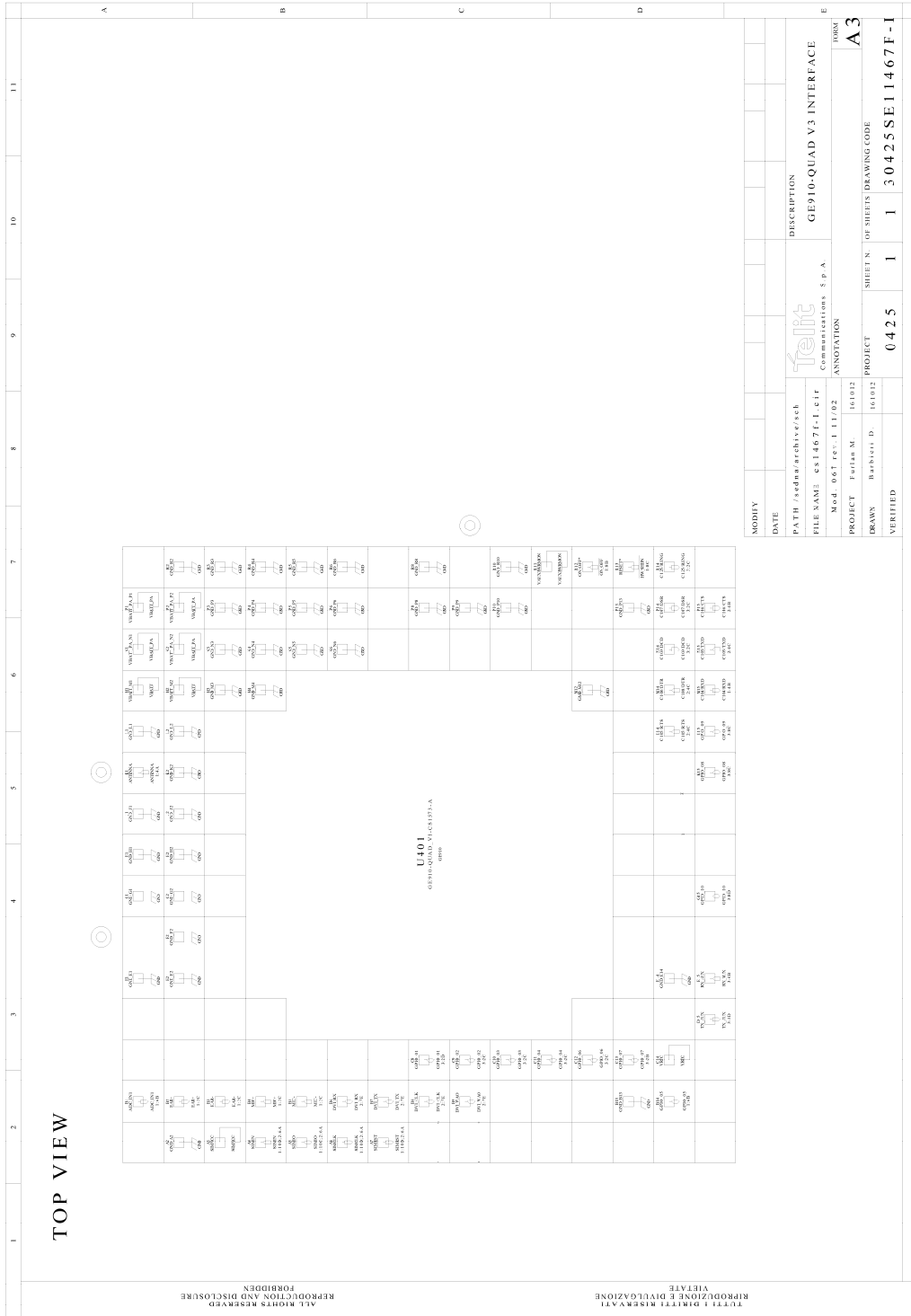

## 44.18. GE865 – JF2 Interface board

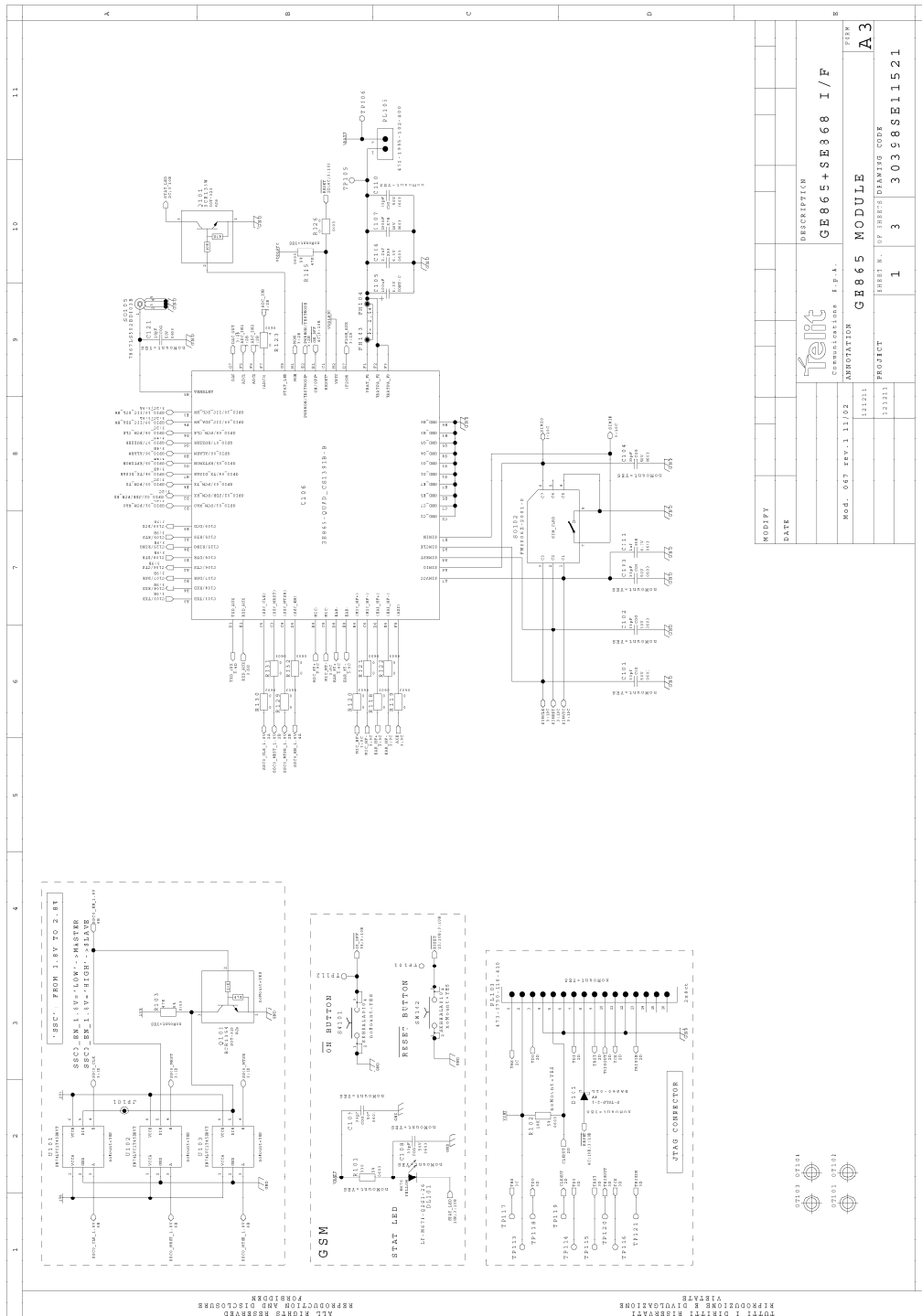

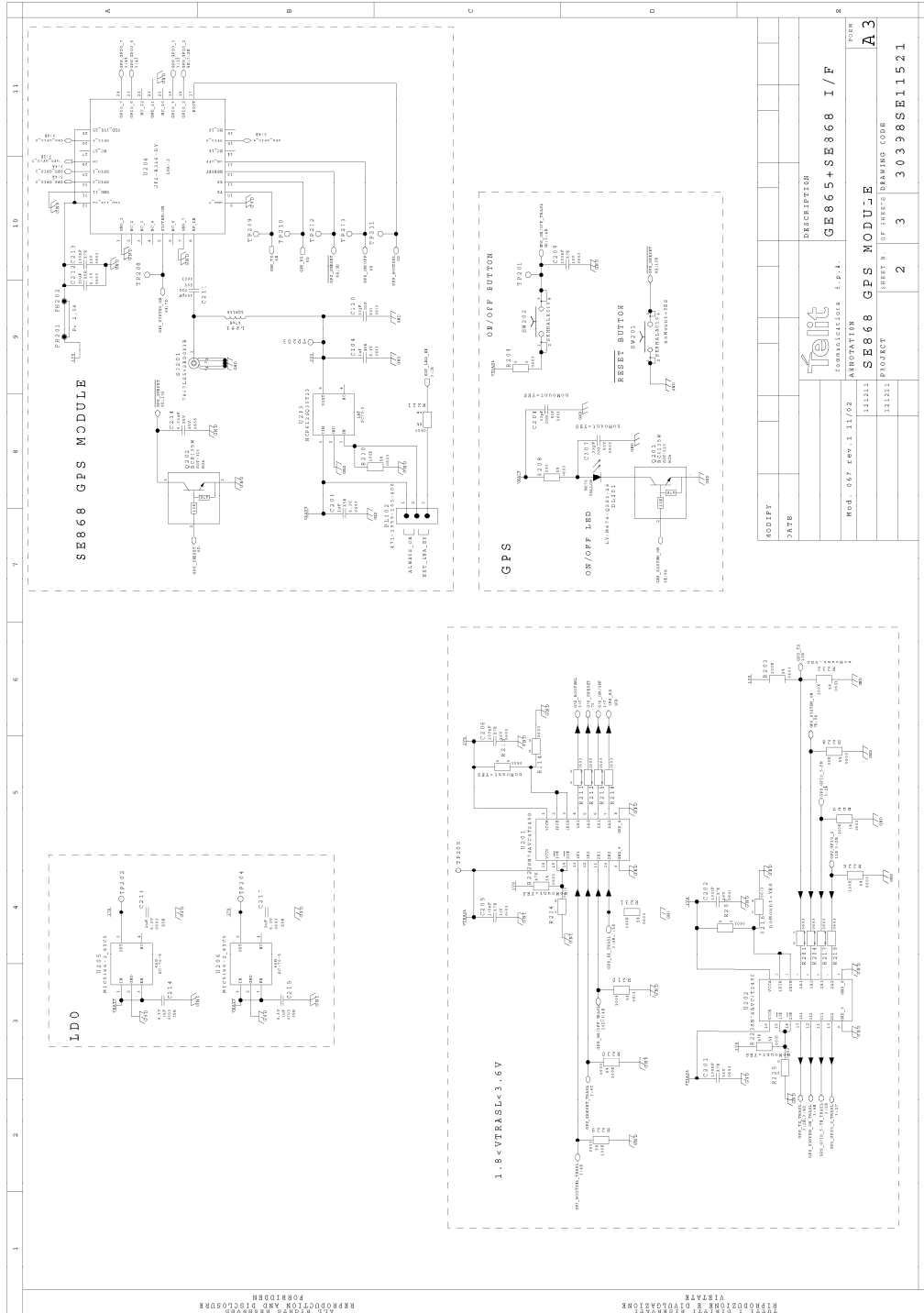

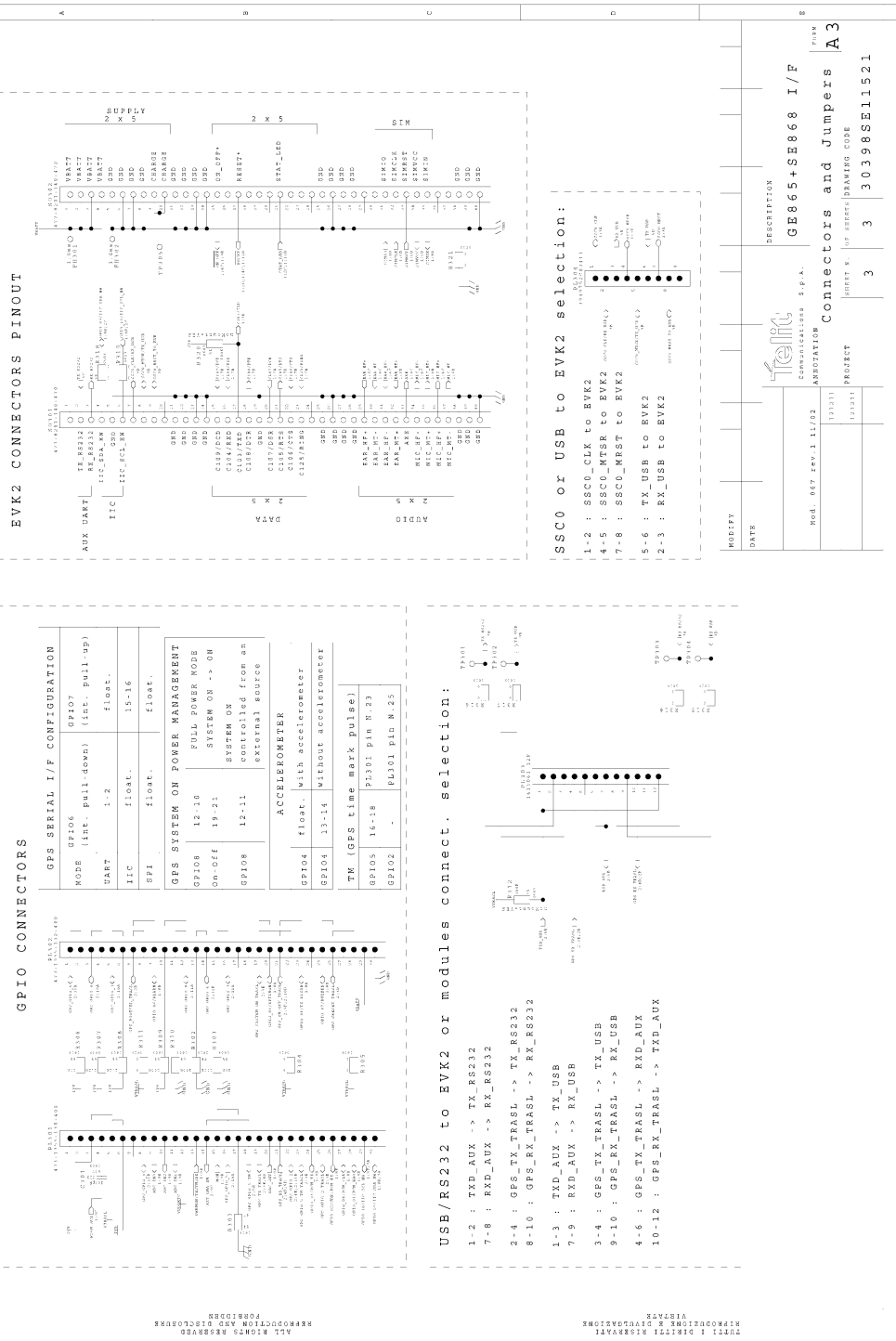

REVISED BY		DESCRIPTION	
DATE			
Mod. 067 rev.1 11/02		Telit Communications S.p.A.	GB865+SE868 I/P
		ADAPTATION PROJECT	Connectors and Jumpers A3
		PROJECT	3 3 30398SE11521





## 44.19. GL865 – SL869/JN3 Interface board

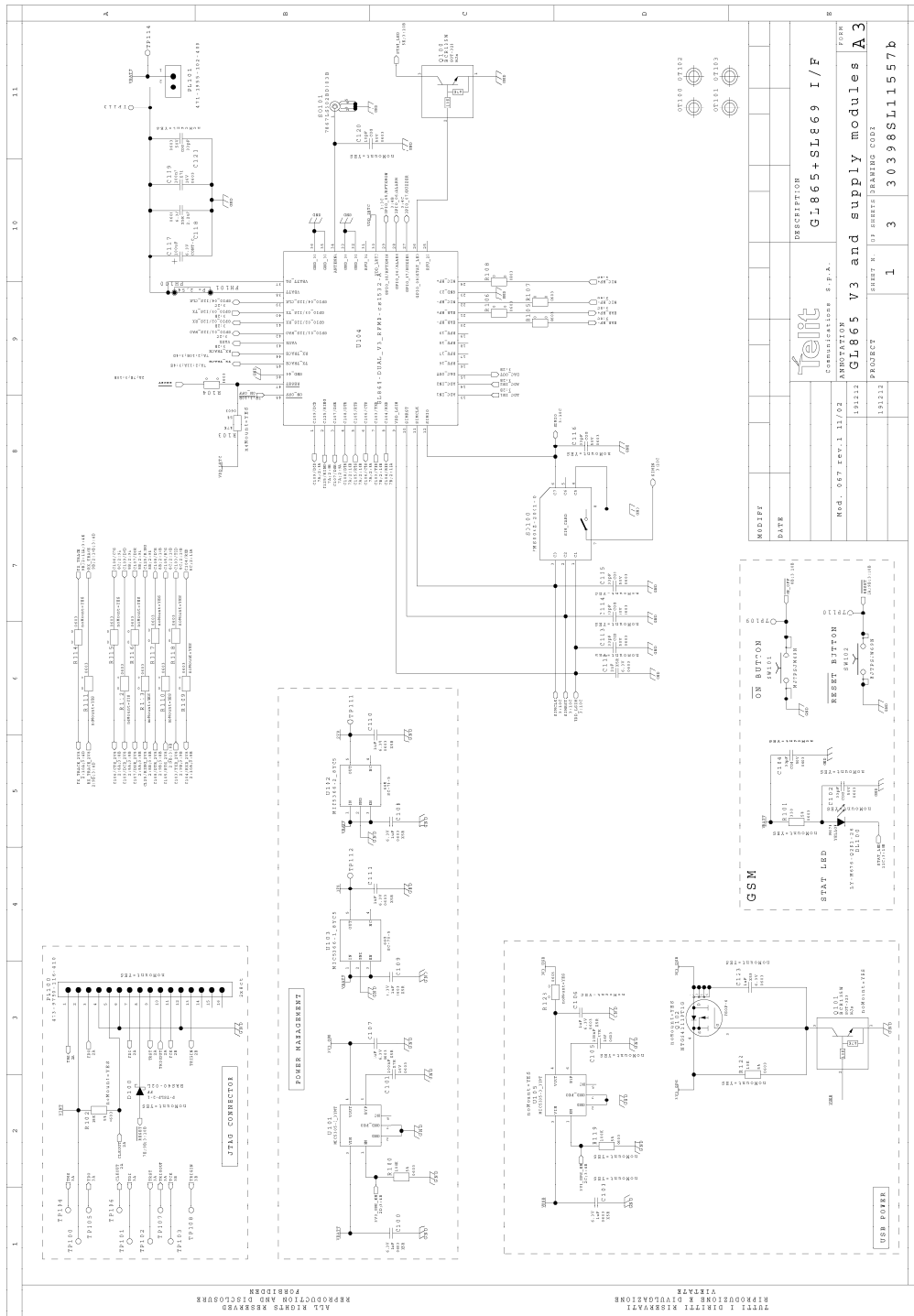

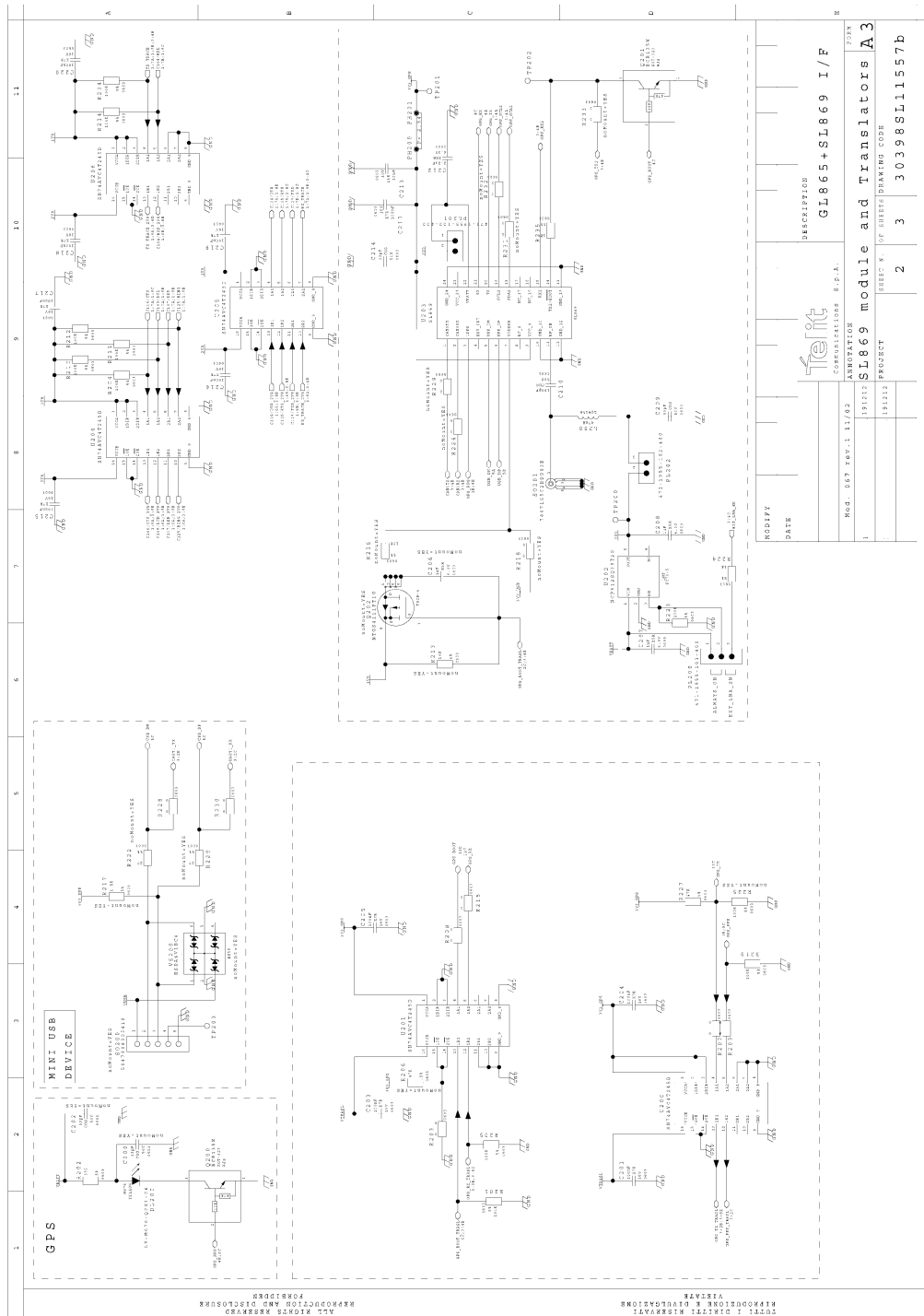

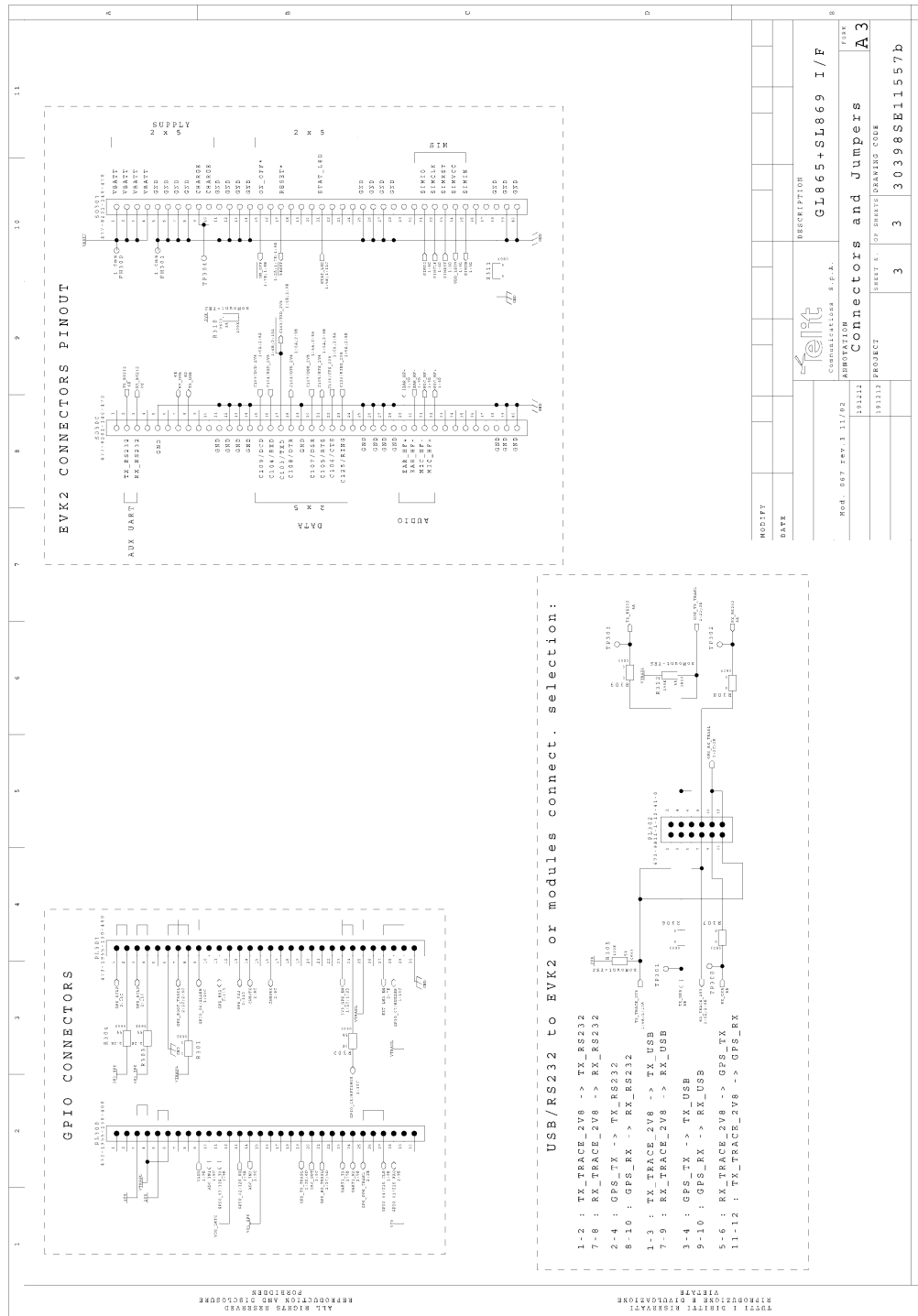

## 44.20. DE910 Interface board

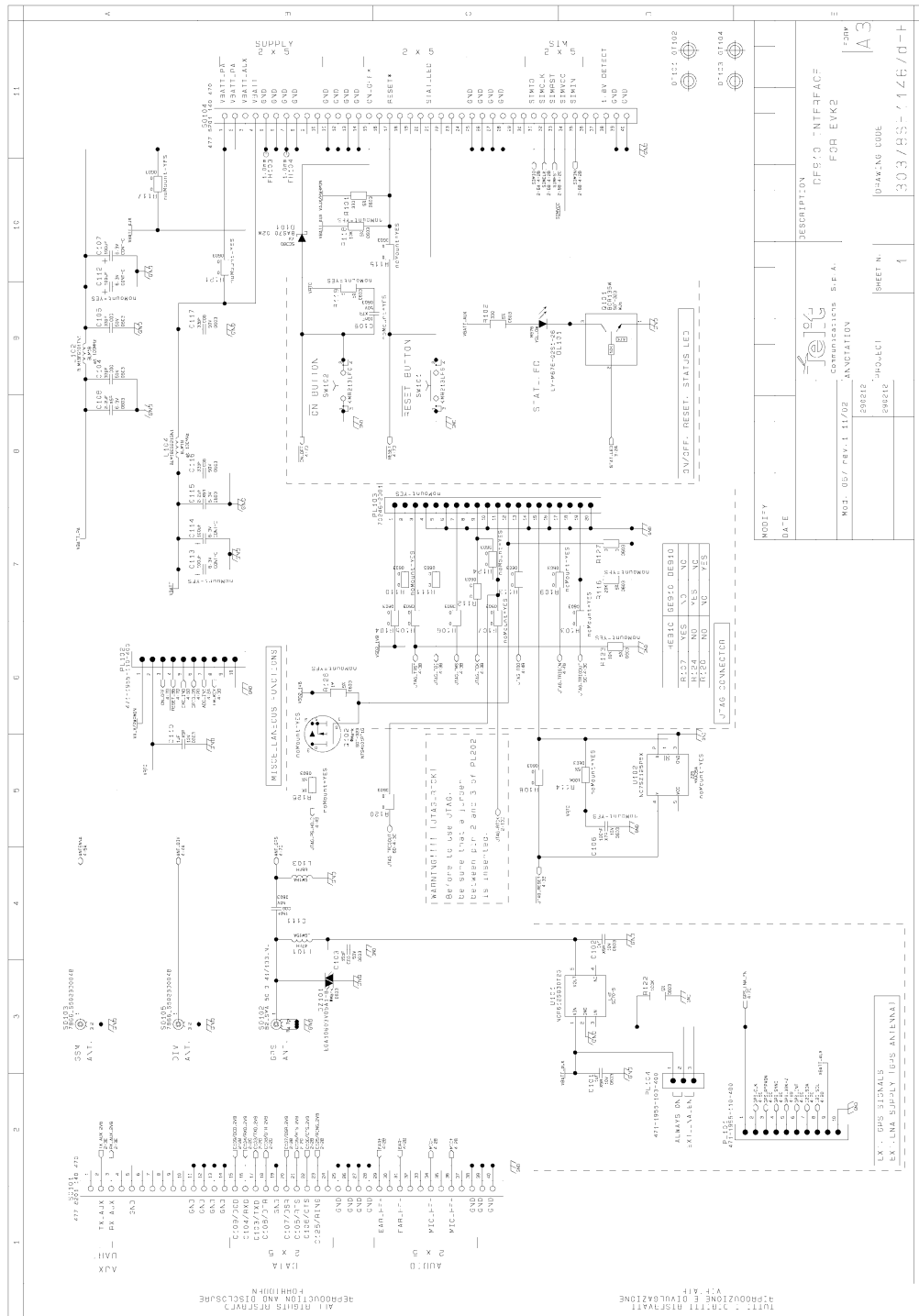

## Telit EVK2 User Guide

1w0300704 Rev.19 – 2015/01/26

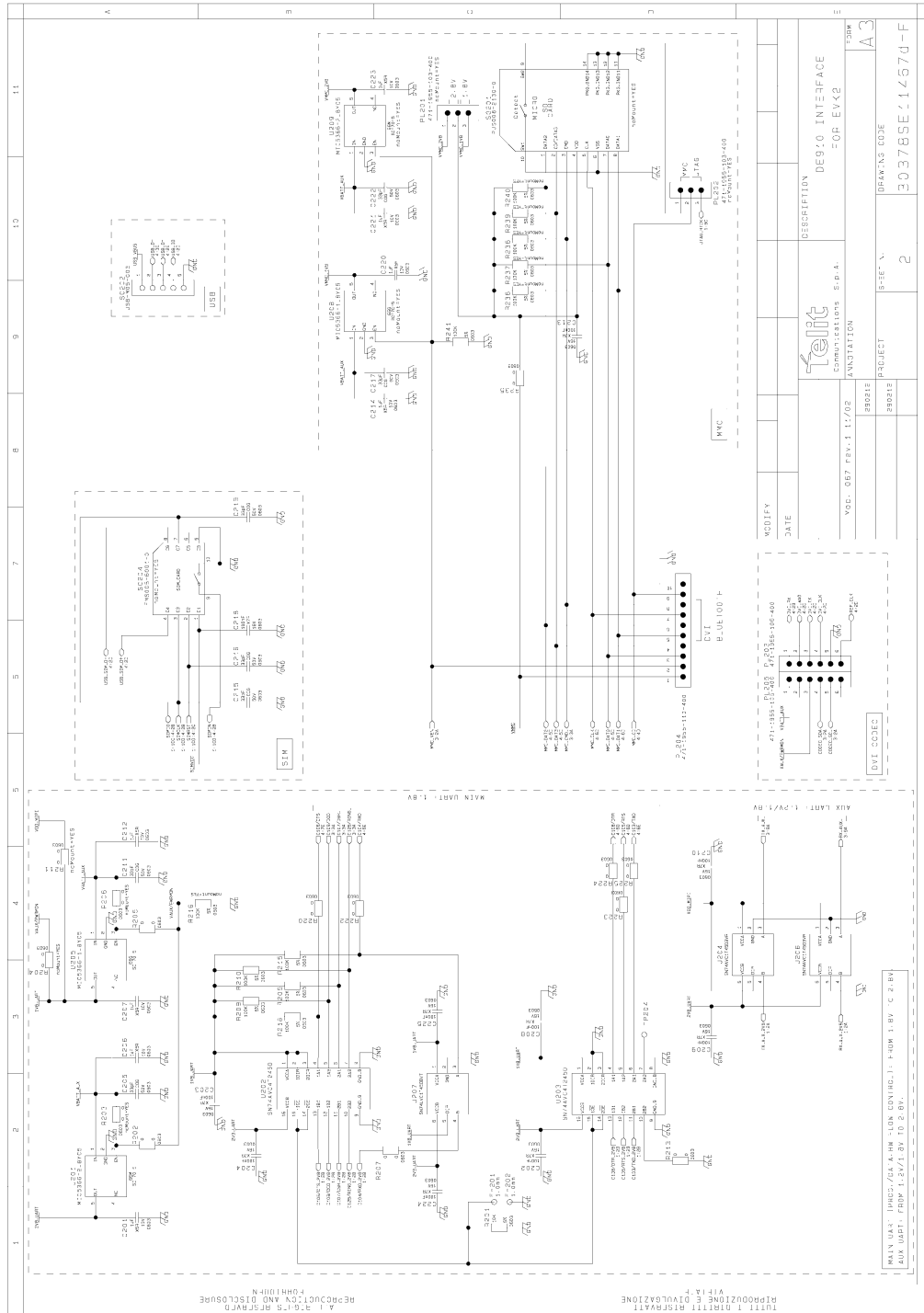



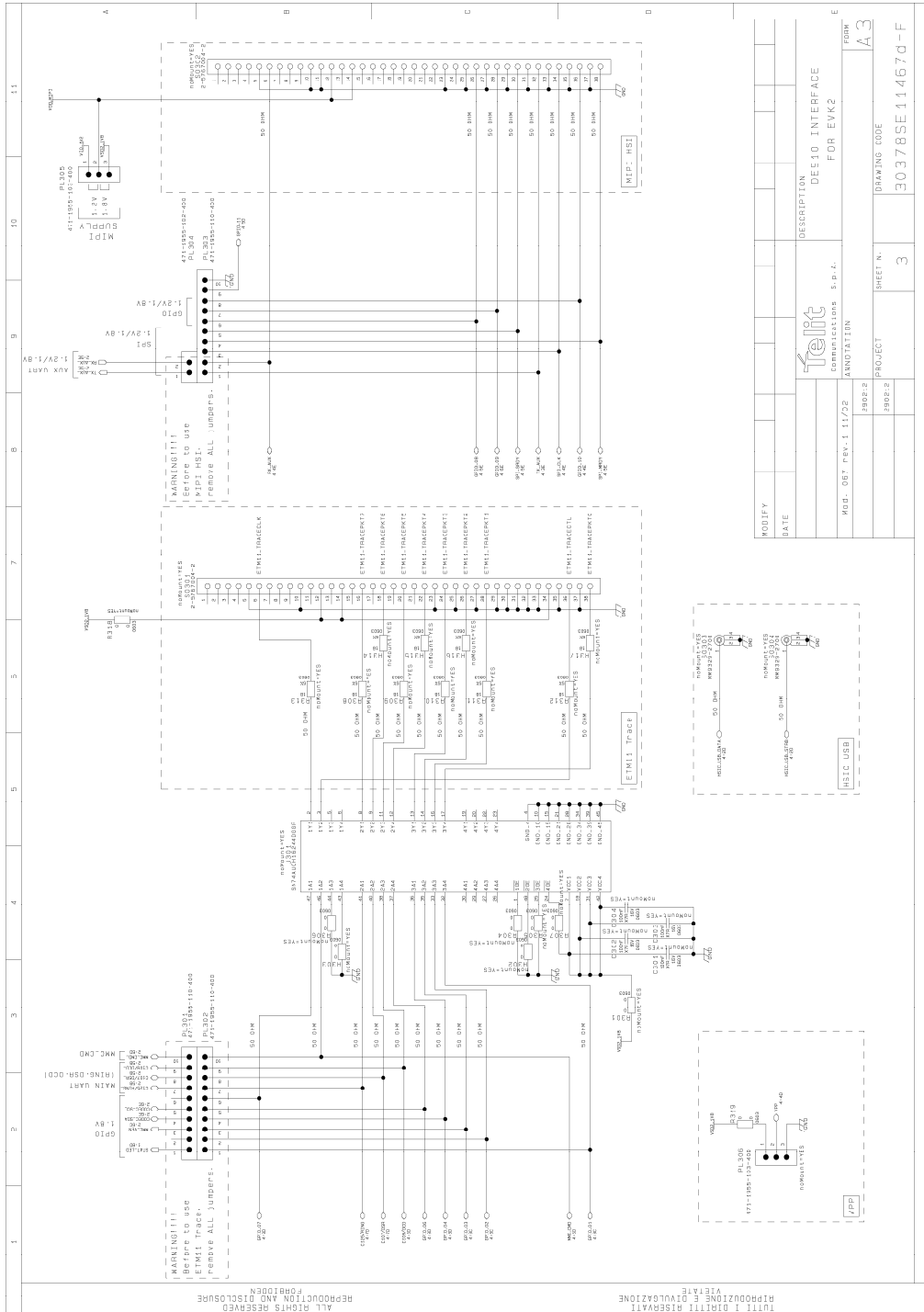

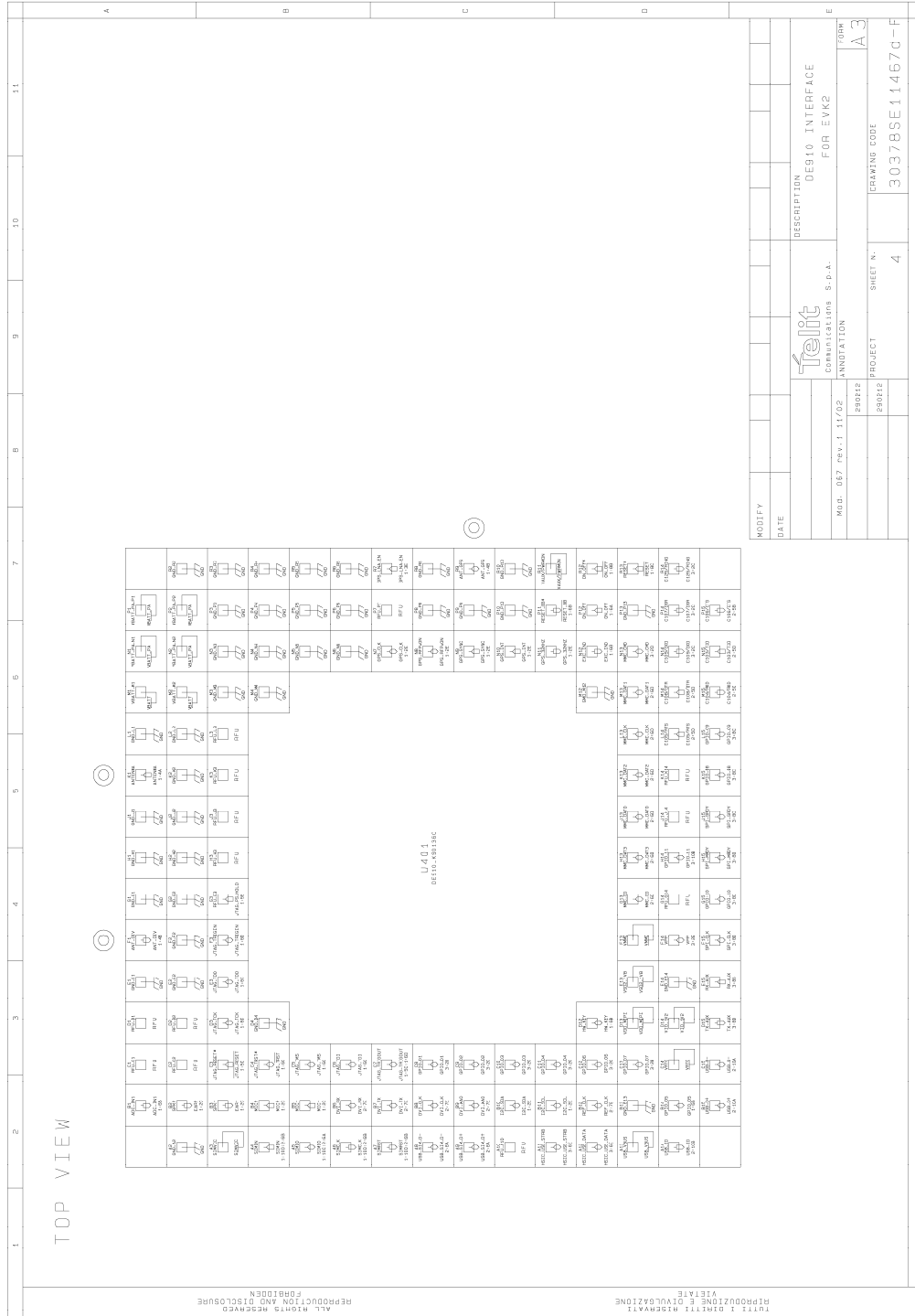

# 44.21. CE910 Interface board

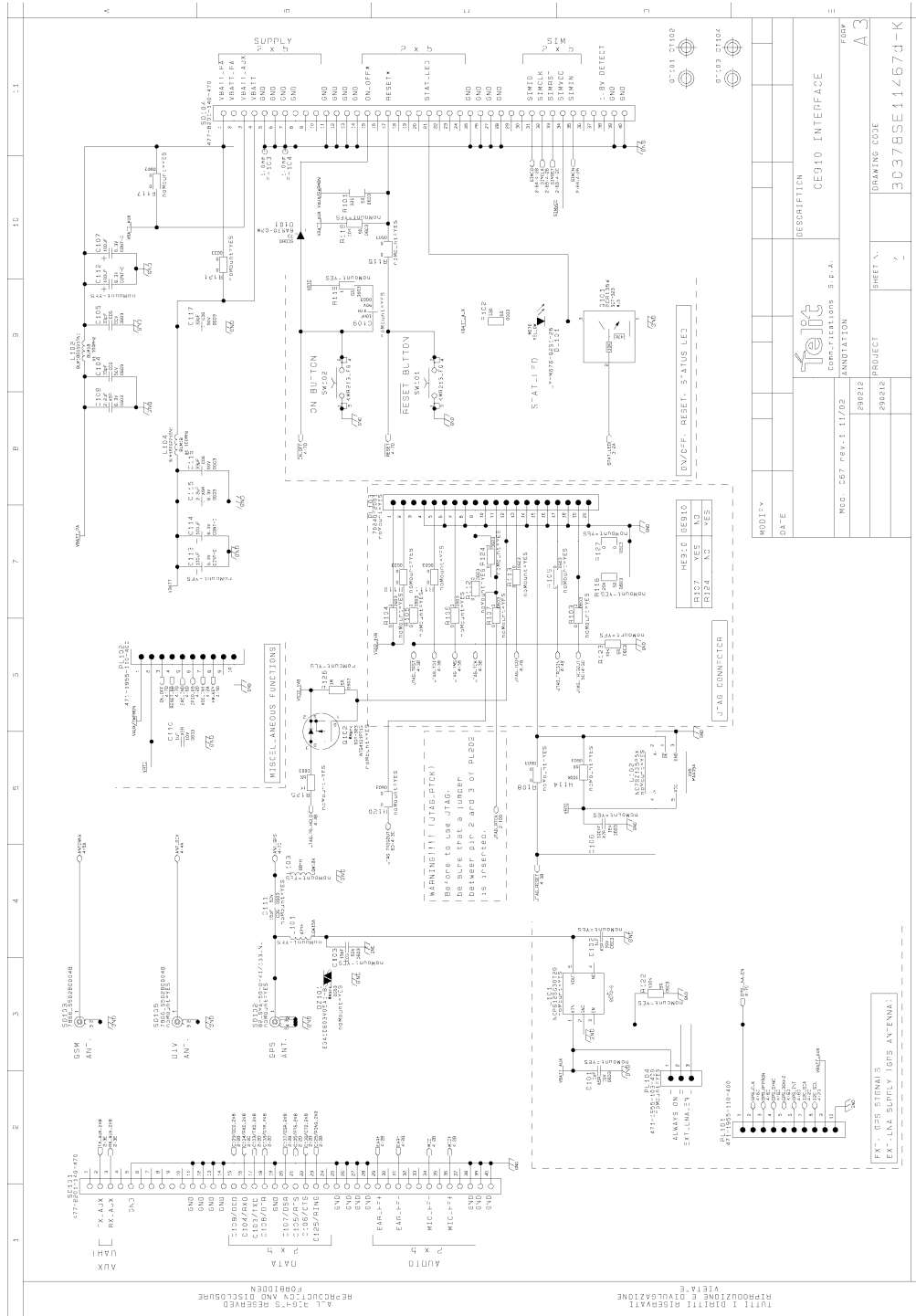

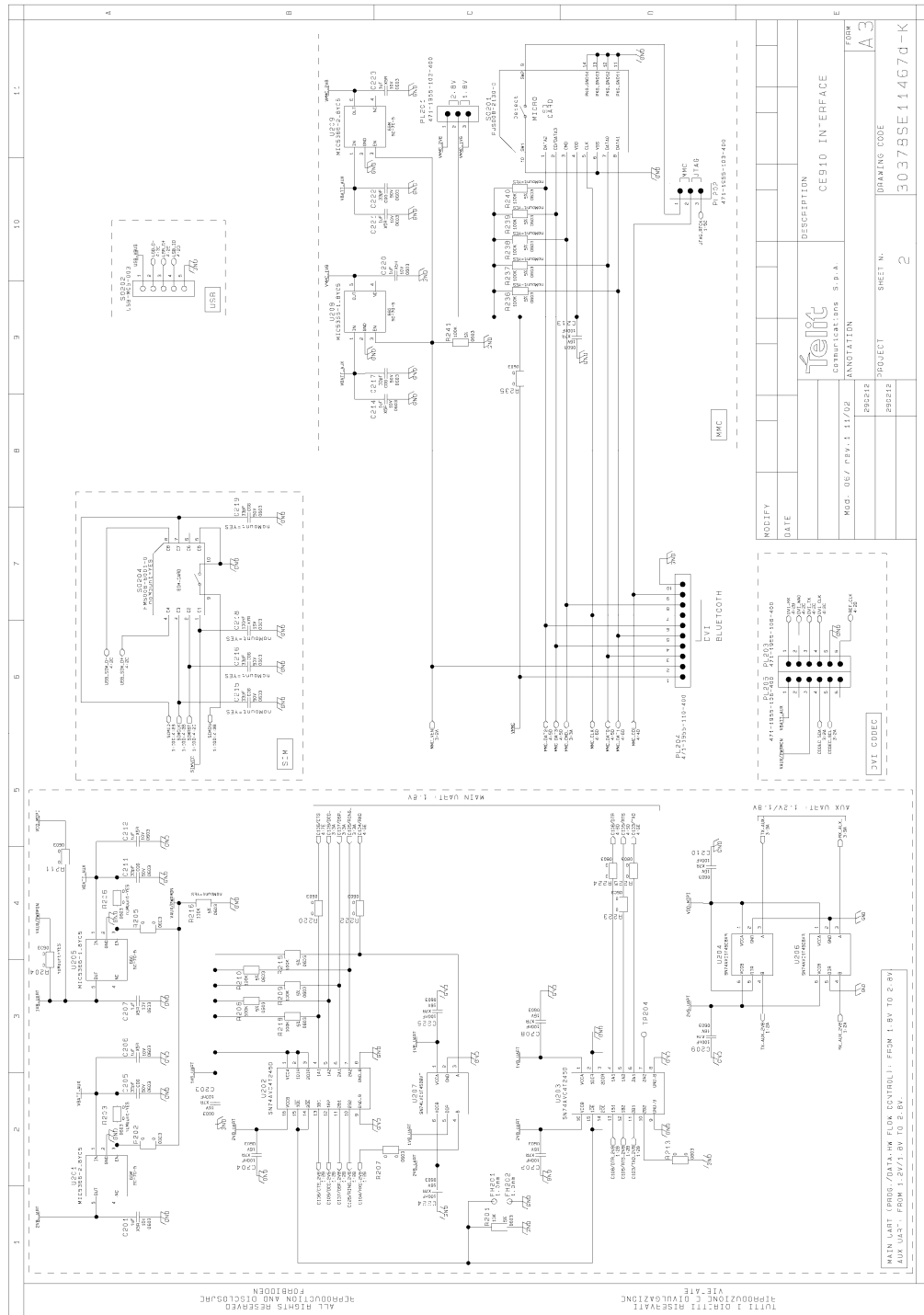

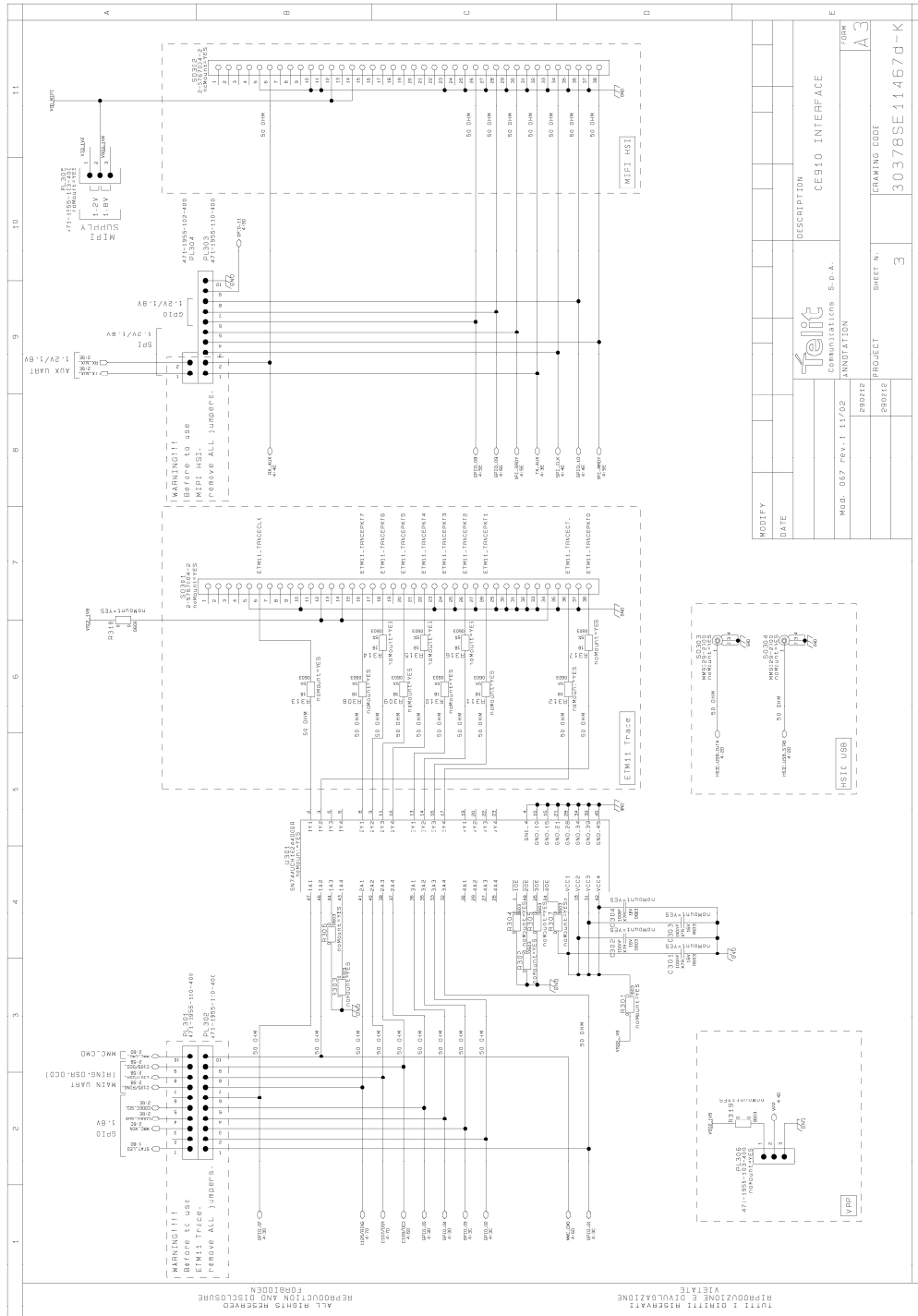



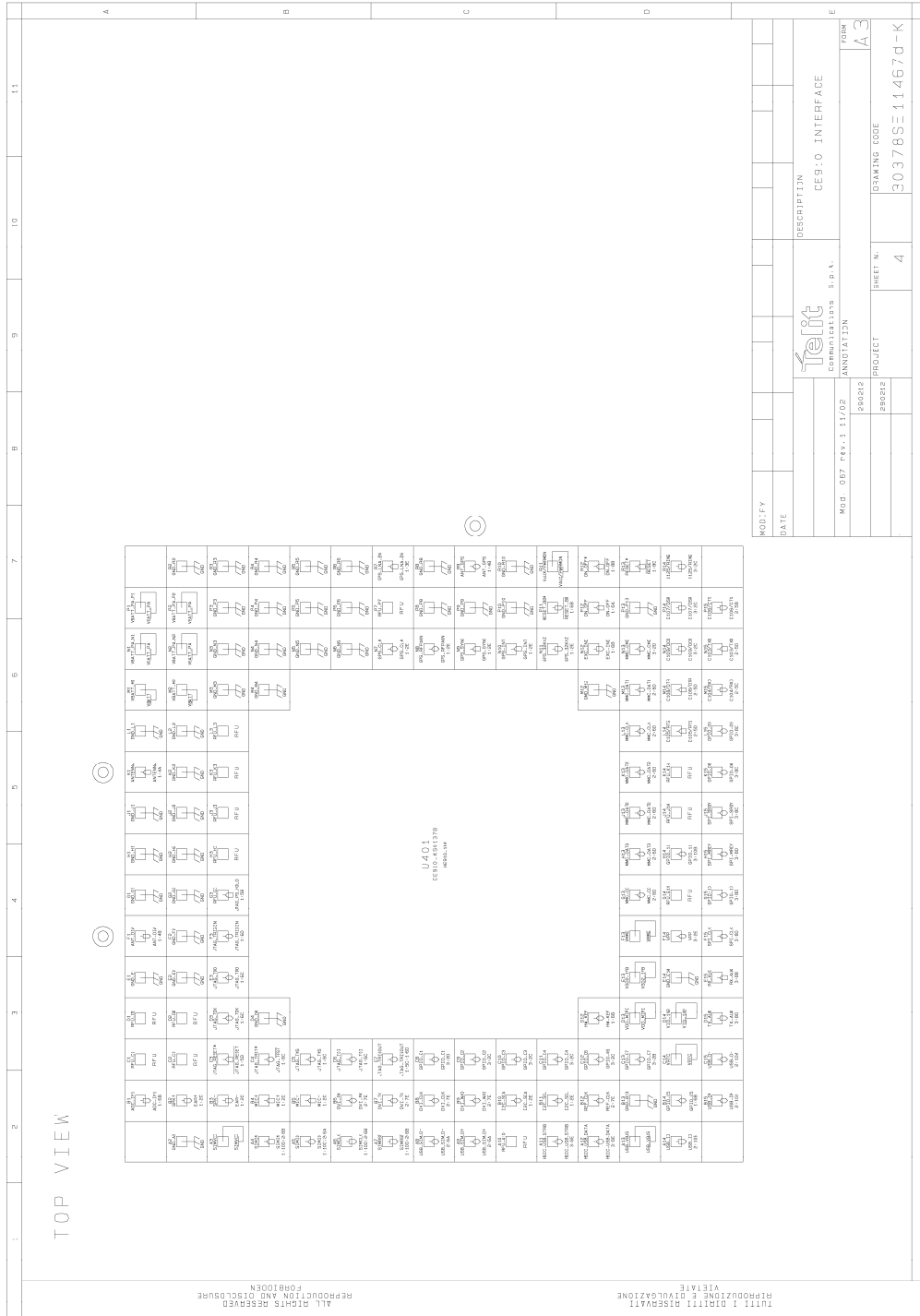

## 44.22. GL865 V3 Interface board

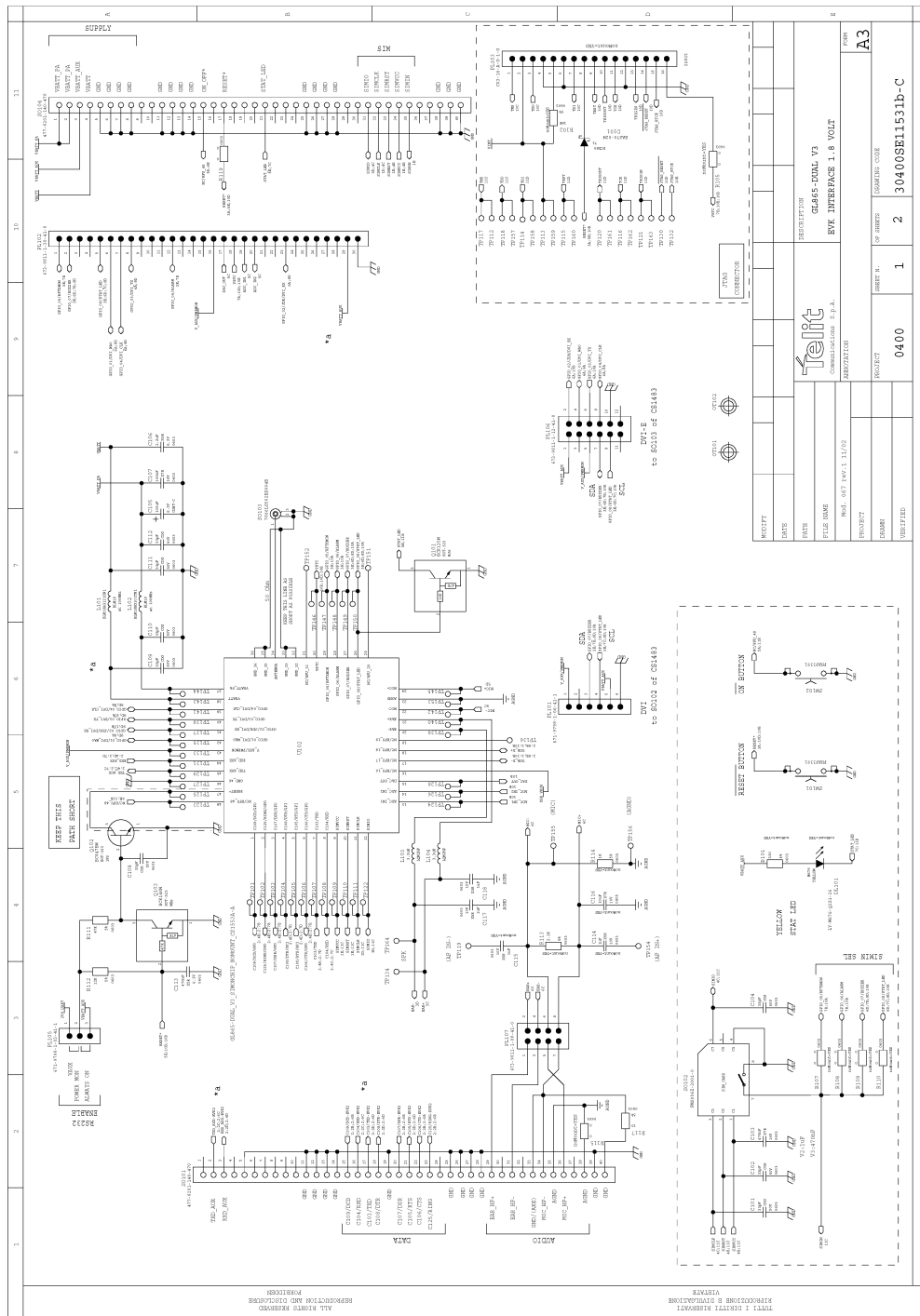

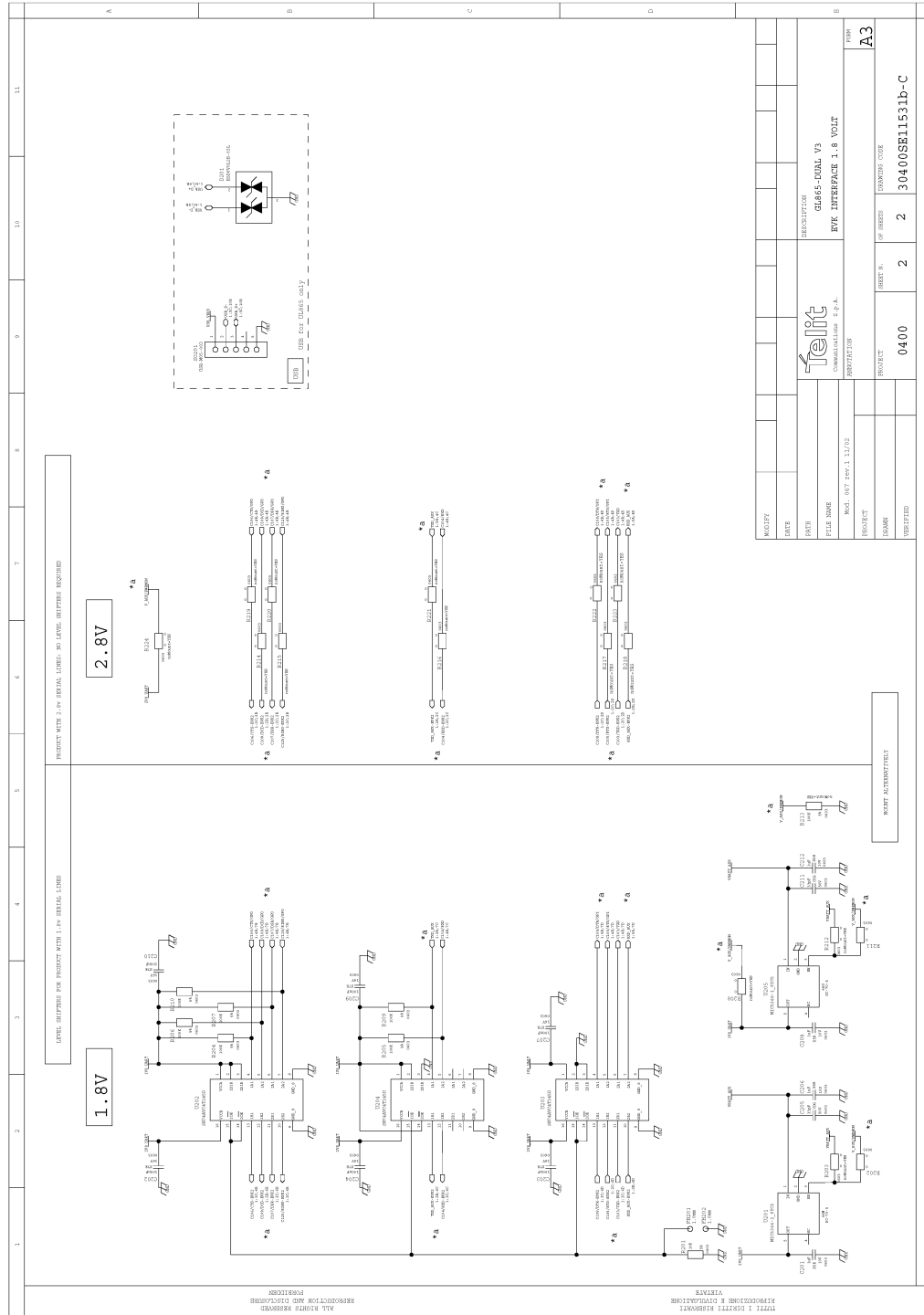

## 44.23. LE920 Interface board

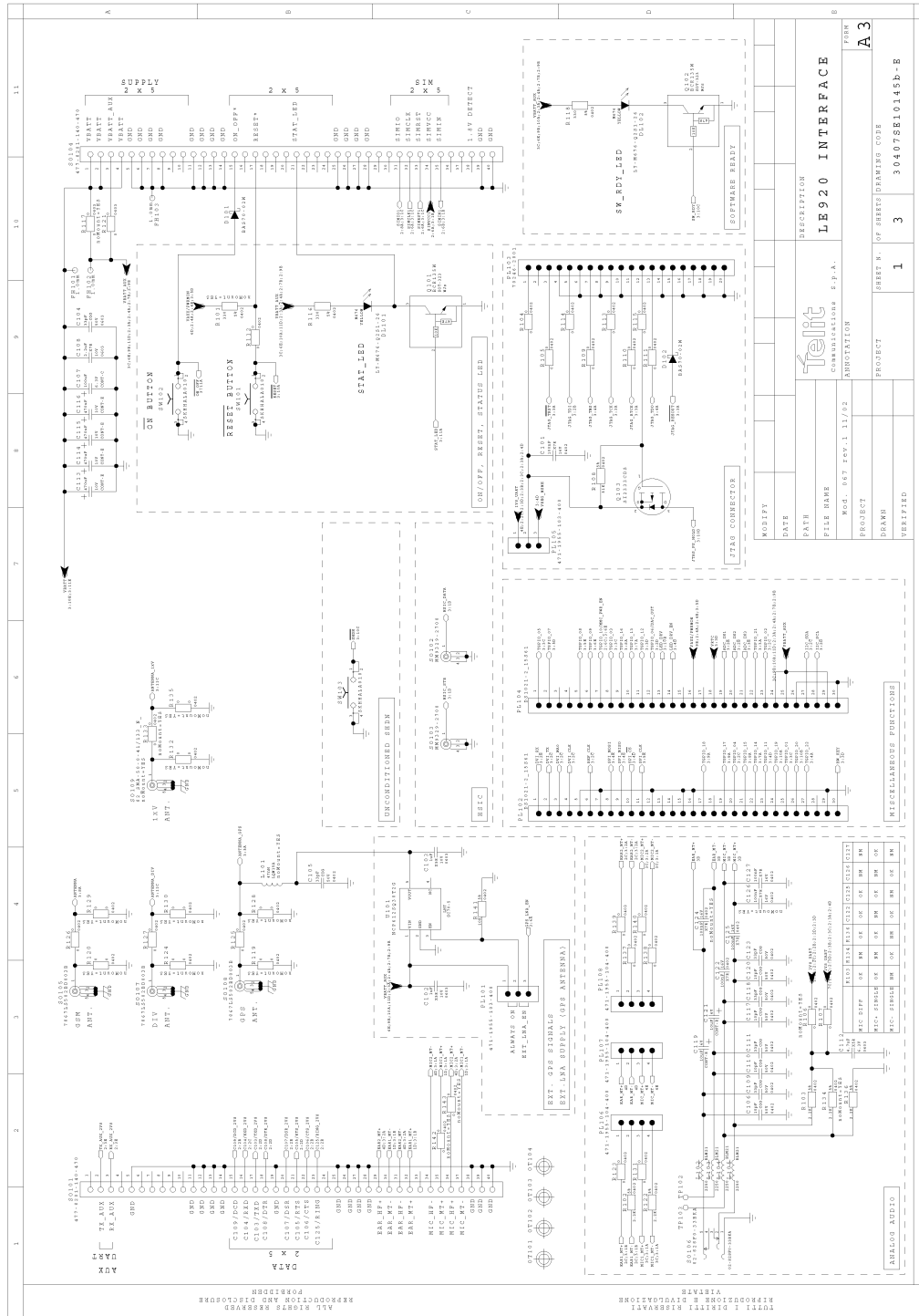

**Telit EVK2 User Guide**  
1w0300704 Rev.19 – 2015/01/26

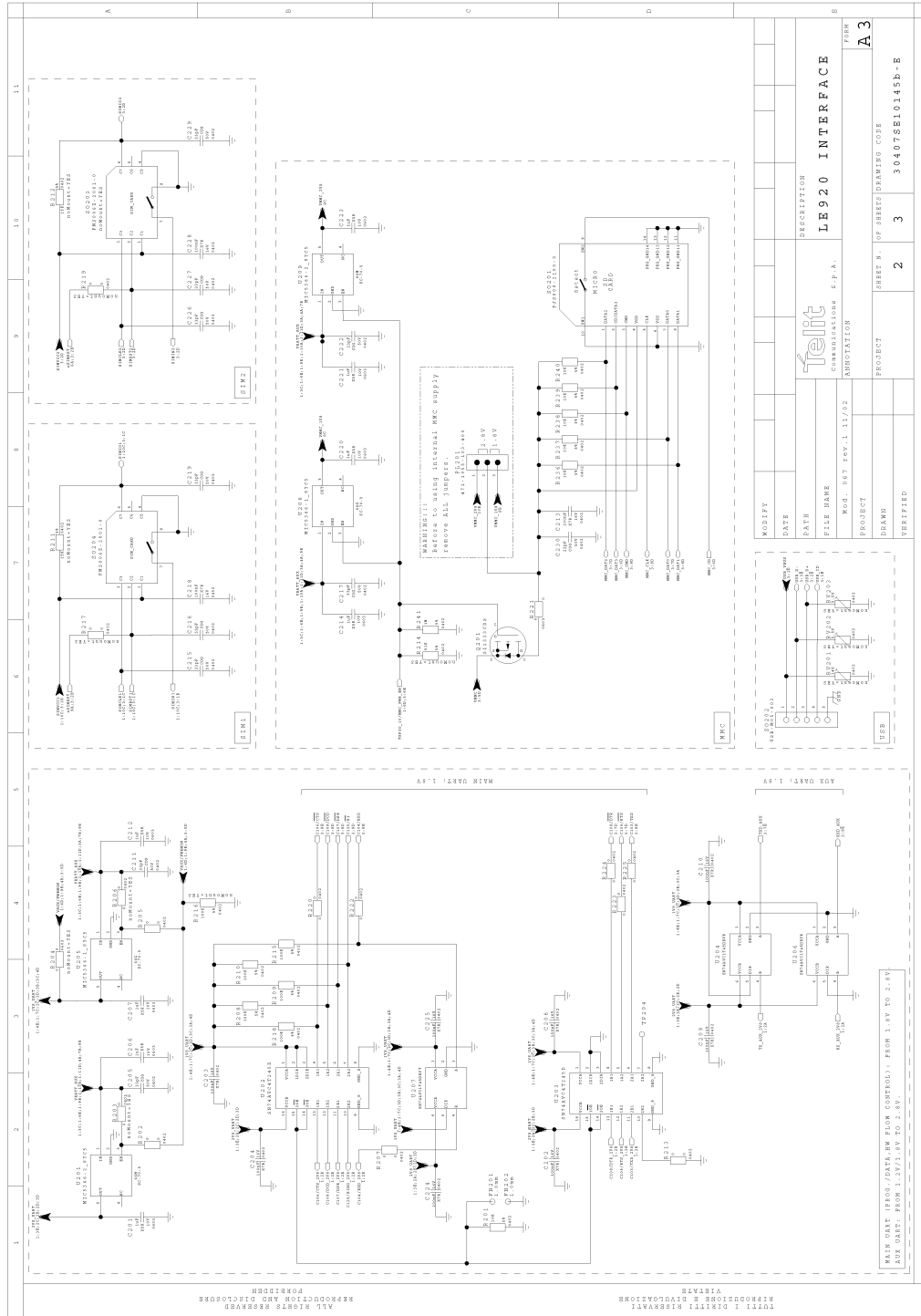

DATE	DESCRIPTION
PAGE	LE920 INTERFACE
FILE NAME	COMMUNICATIONS S.p.A.
Mod. 067 rev. 1.11/02	PROJECT
PROJECT	SHEET N. OF SHEET DRAWING CODE
BOARD	2 3 30407S810145B-B
VERIFIED	FORM
	A3





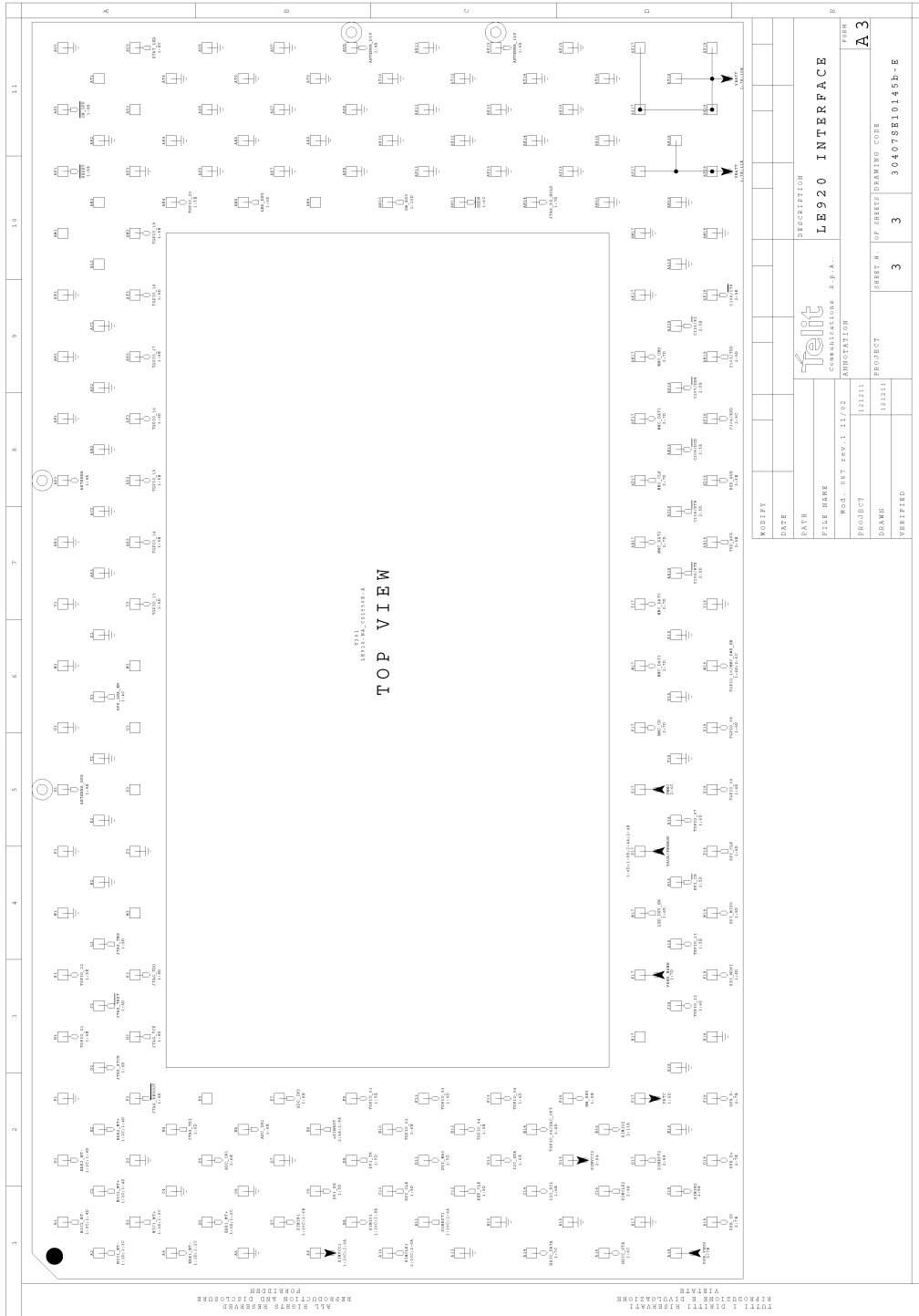

## 44.24. HE920 family Interface board

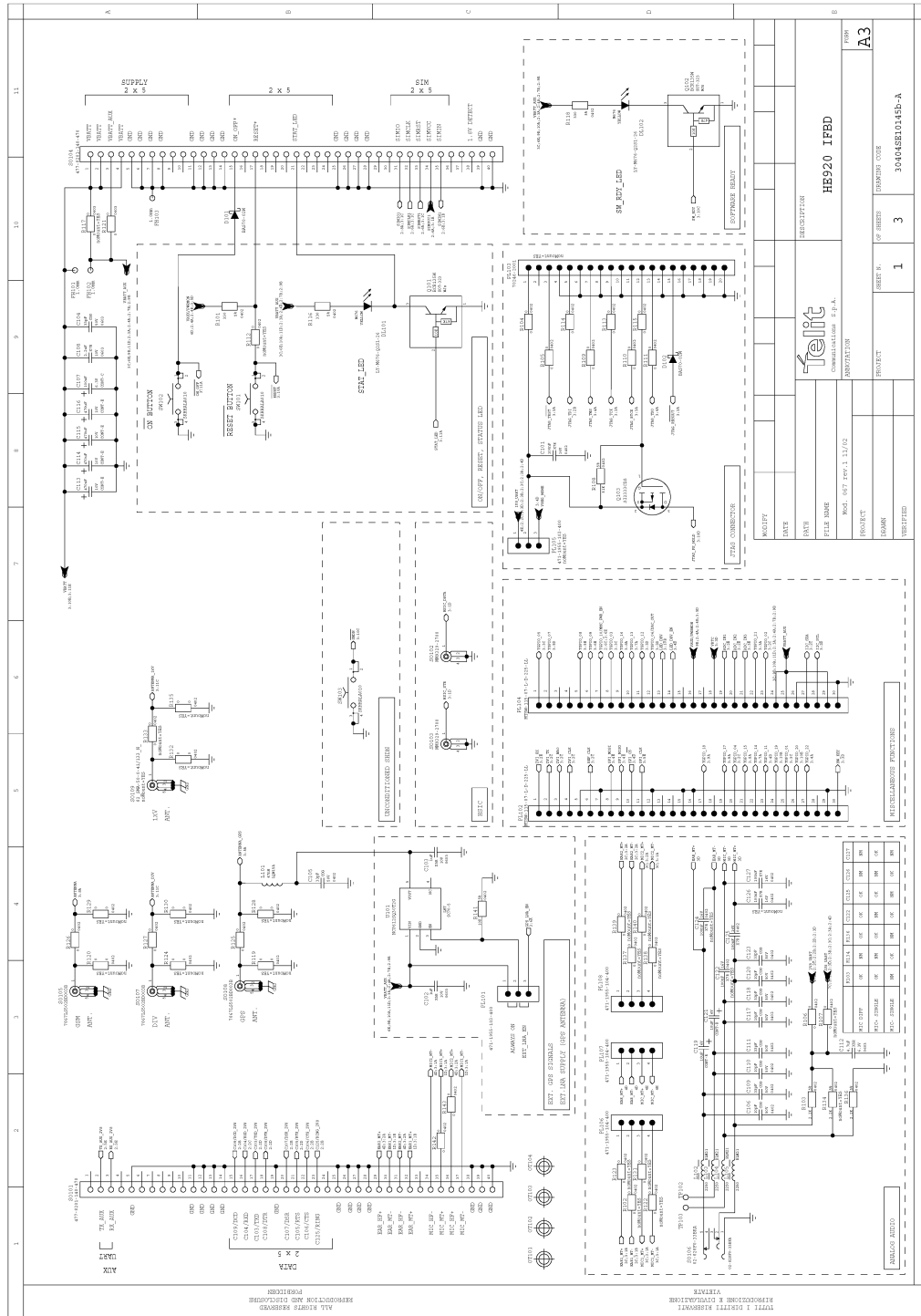

**Telit EVK2 User Guide**  
1w0300704 Rev.19 – 2015/01/26

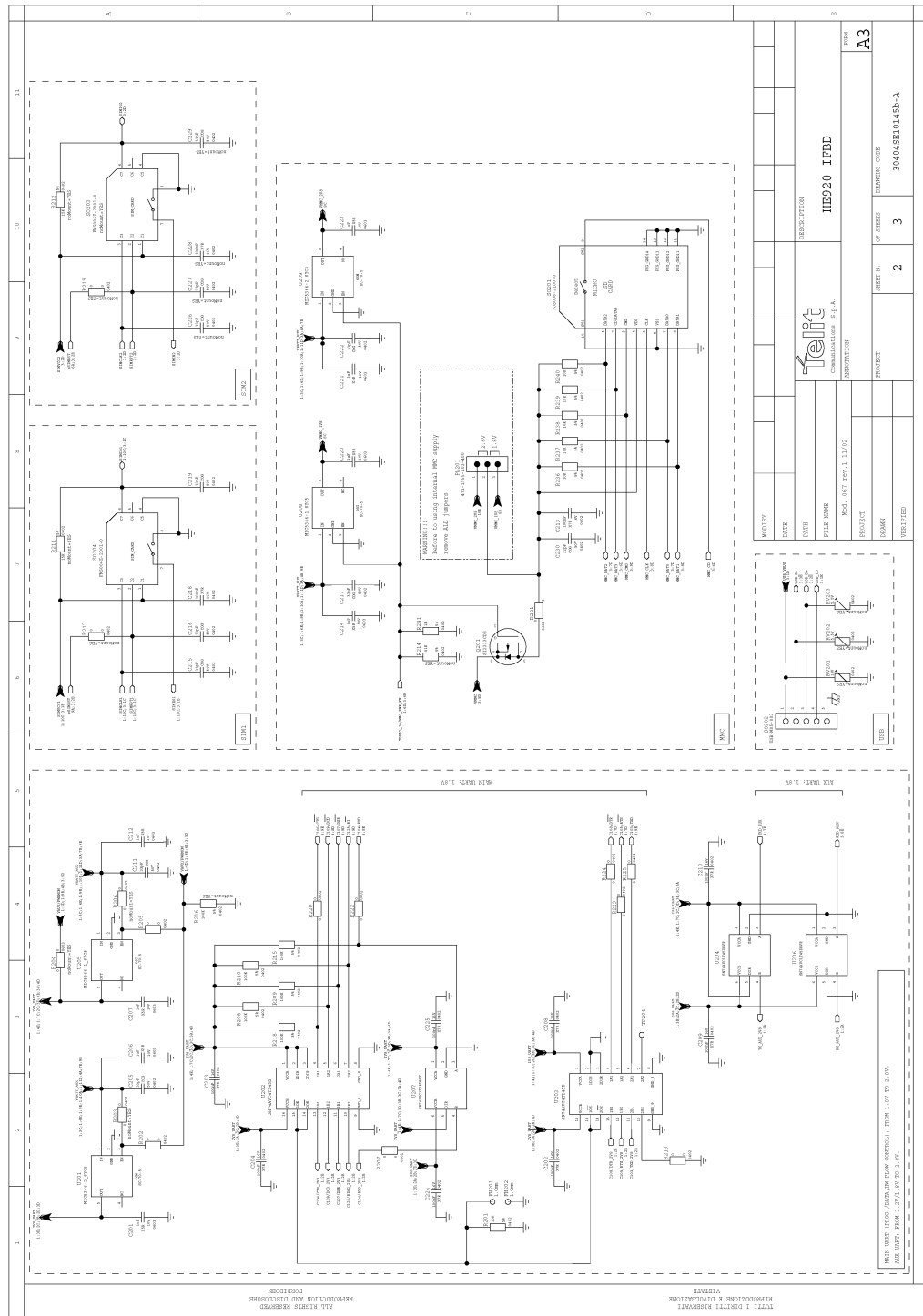

**Telit EVK2 User Guide**  
1w0300704 Rev.19 – 2015/01/26

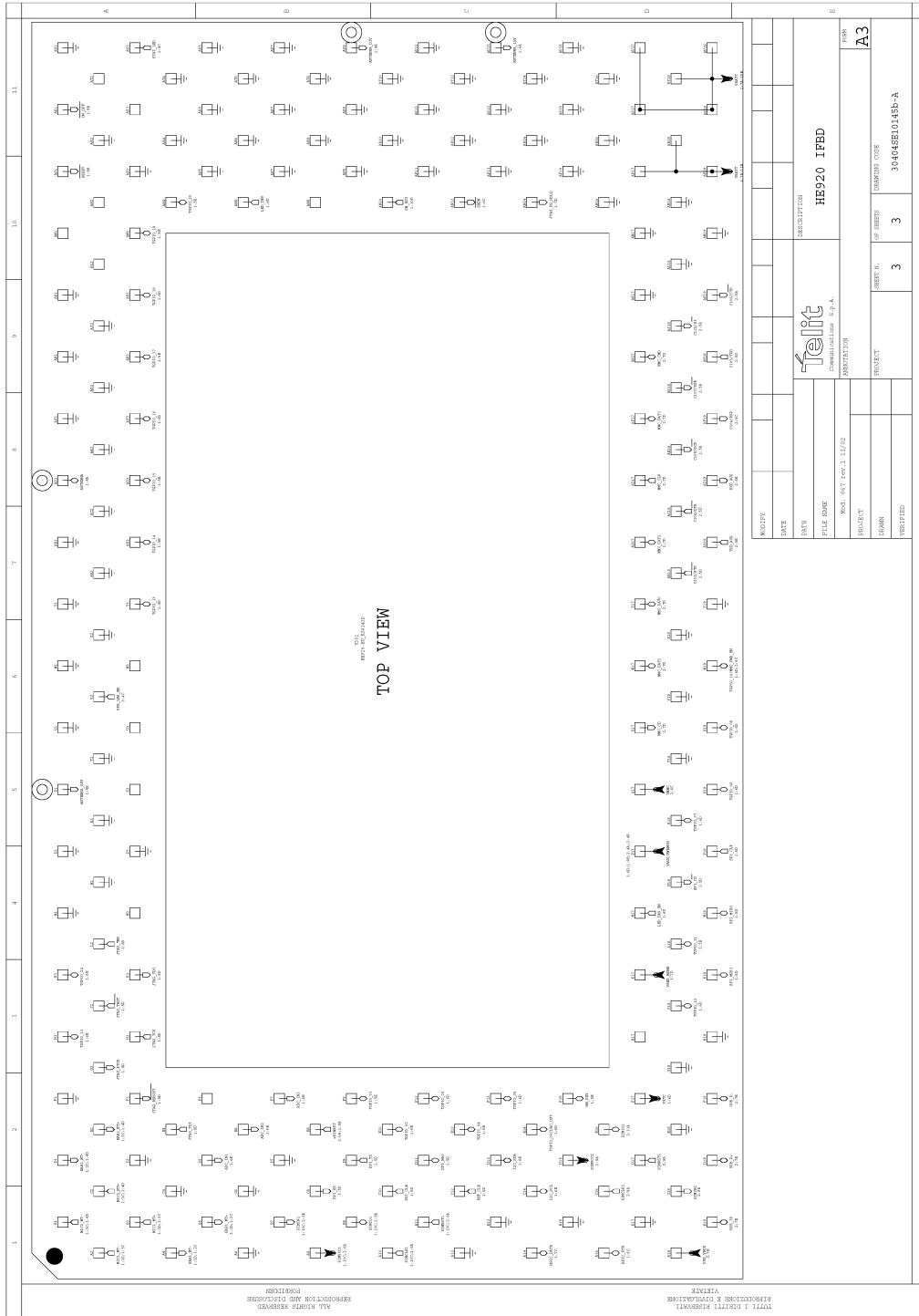

## 44.25. HE910 V2 Interface board

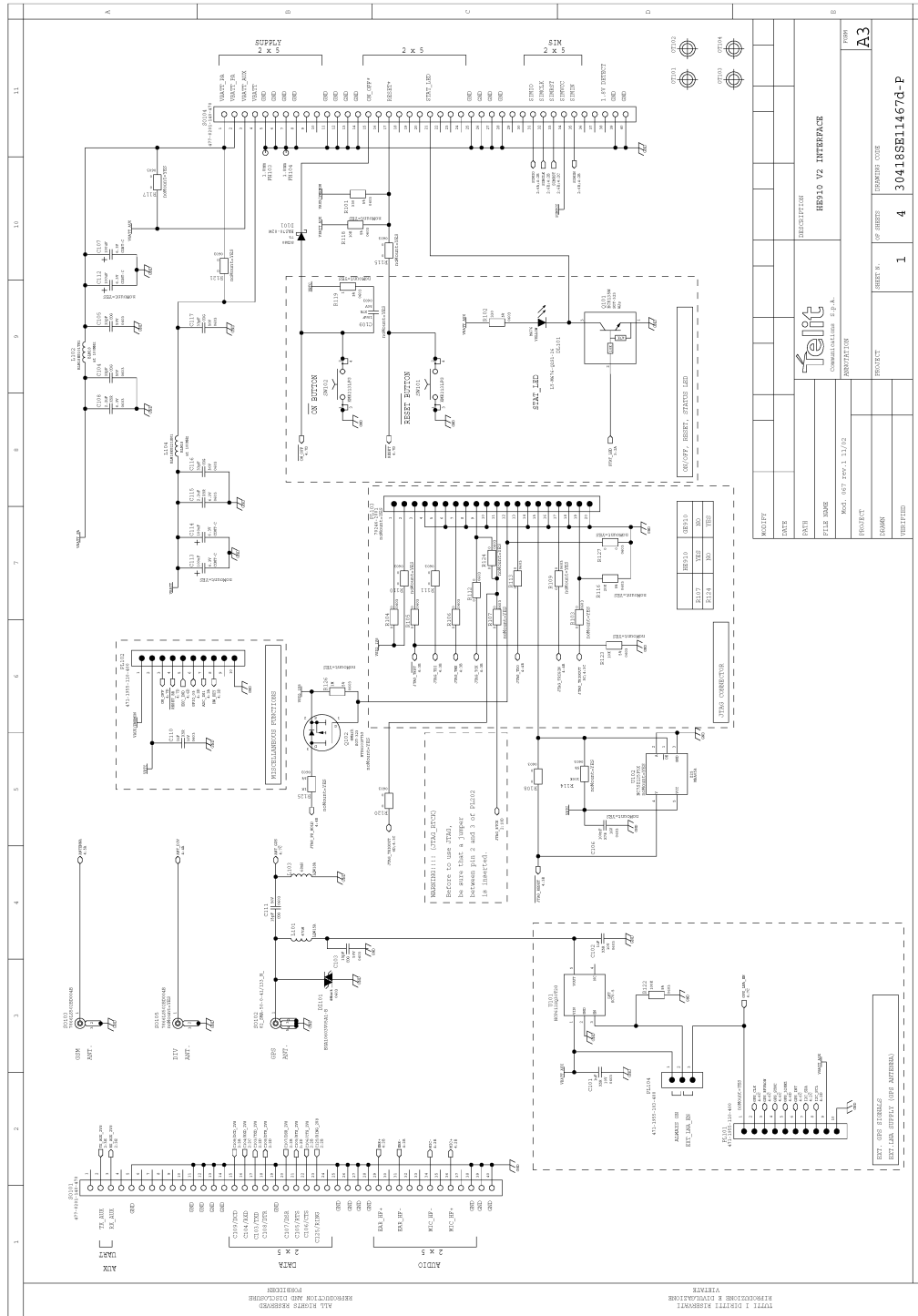



# Telit EVK2 User Guide

1w0300704 Rev.19 – 2015/01/26

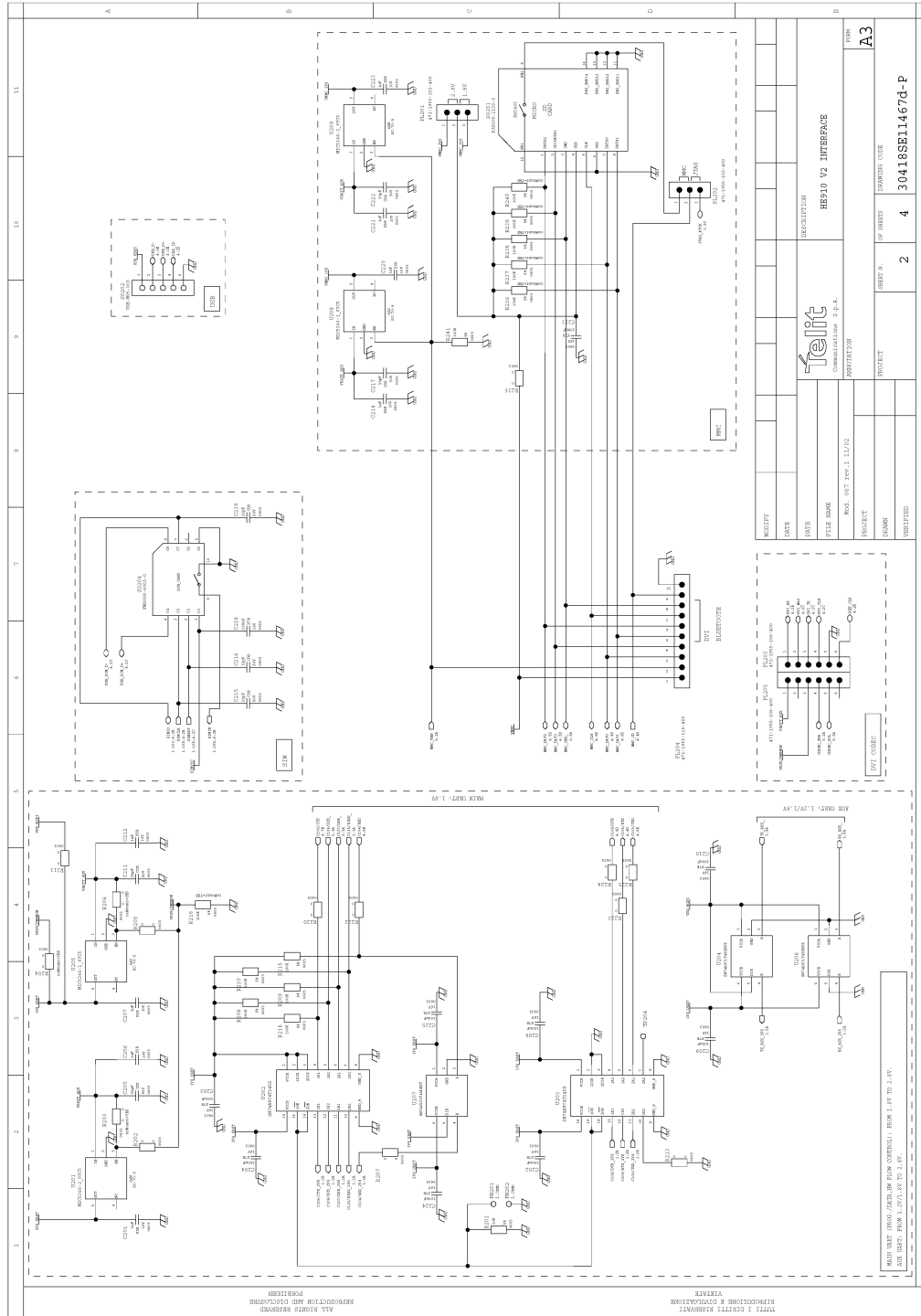

**Telit EVK2 User Guide**  
1w0300704 Rev.19 – 2015/01/26

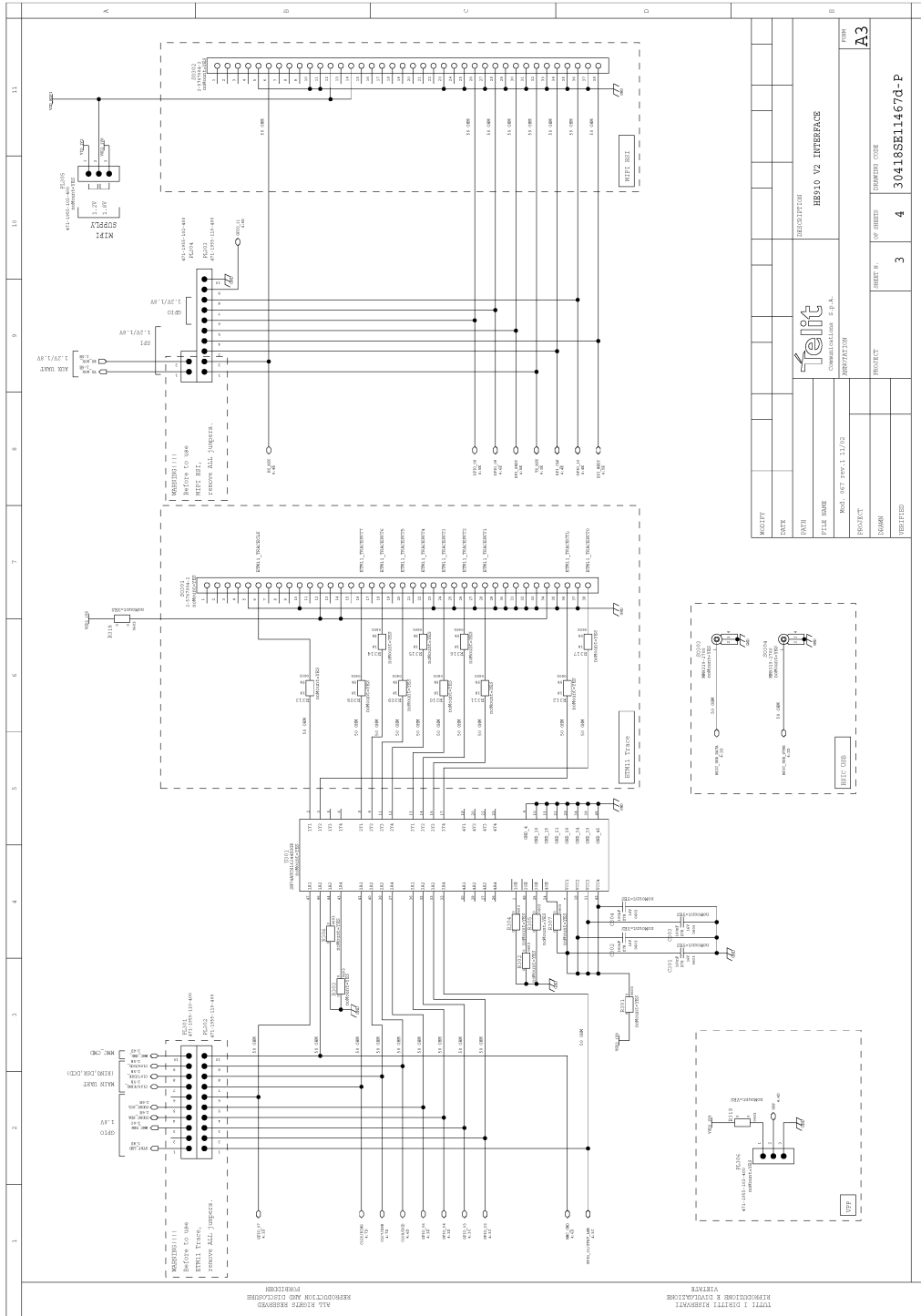

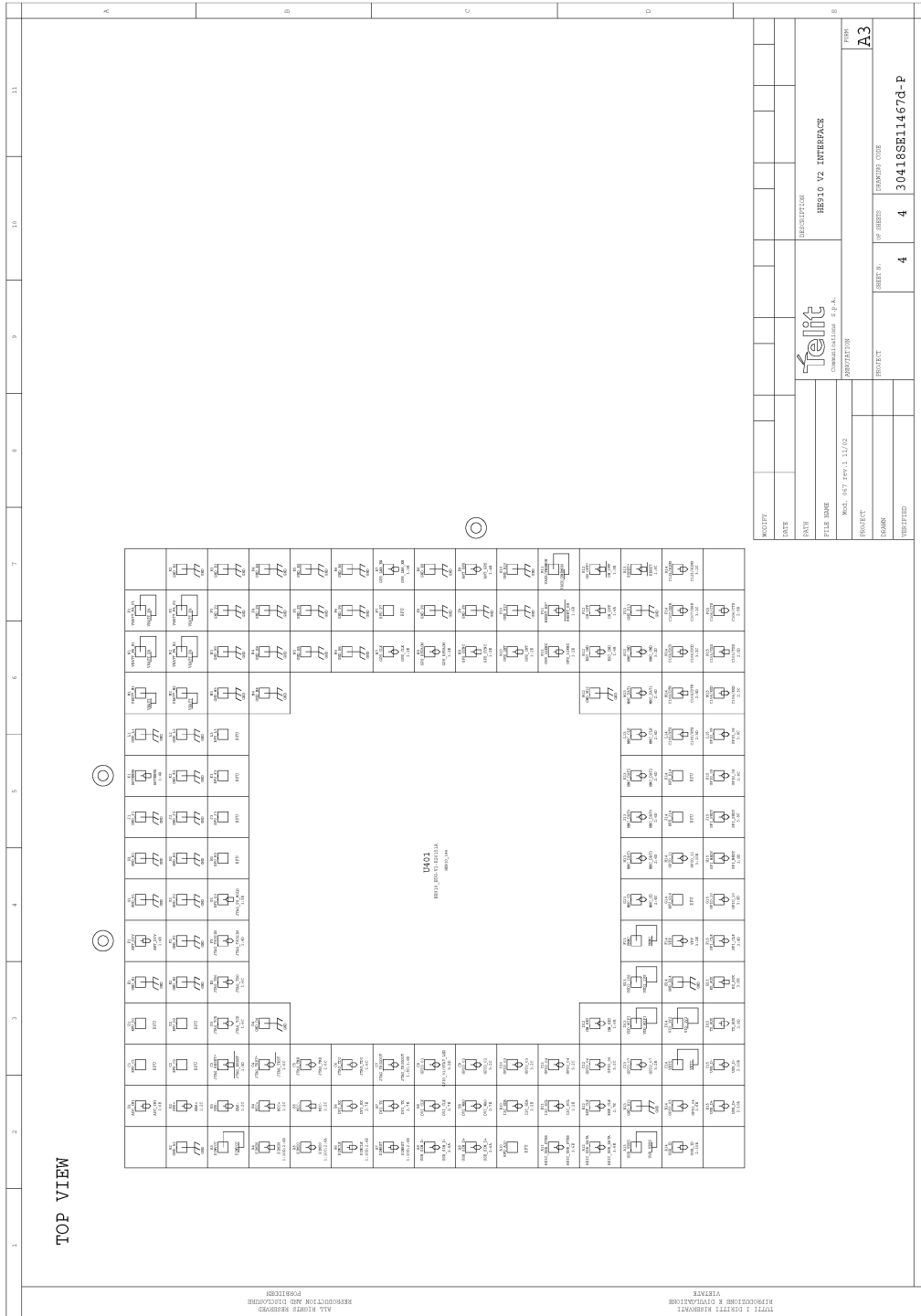

## 44.26. UE910 V2 Interface board

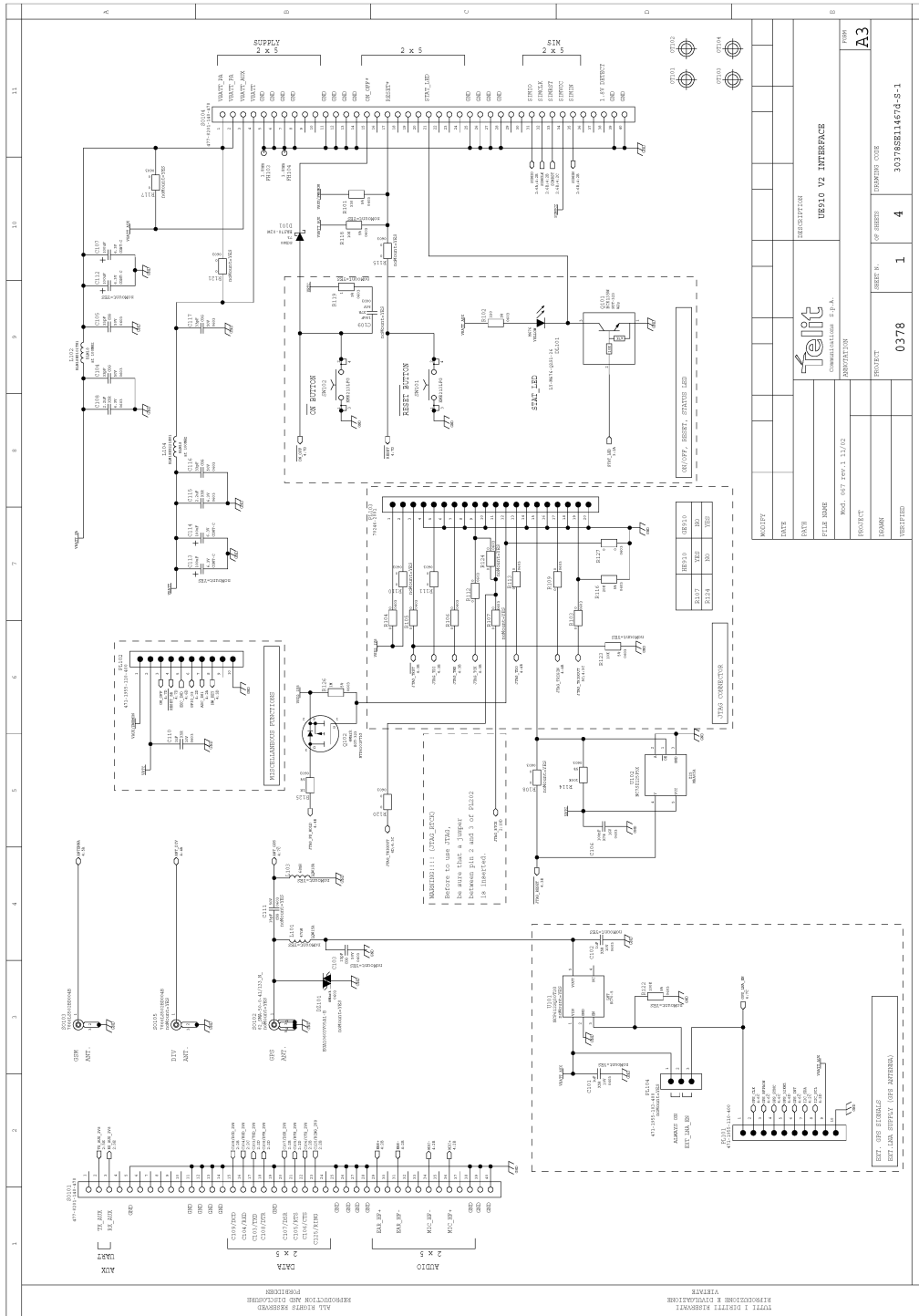

**Telit EVK2 User Guide**  
1w0300704 Rev.19 – 2015/01/26

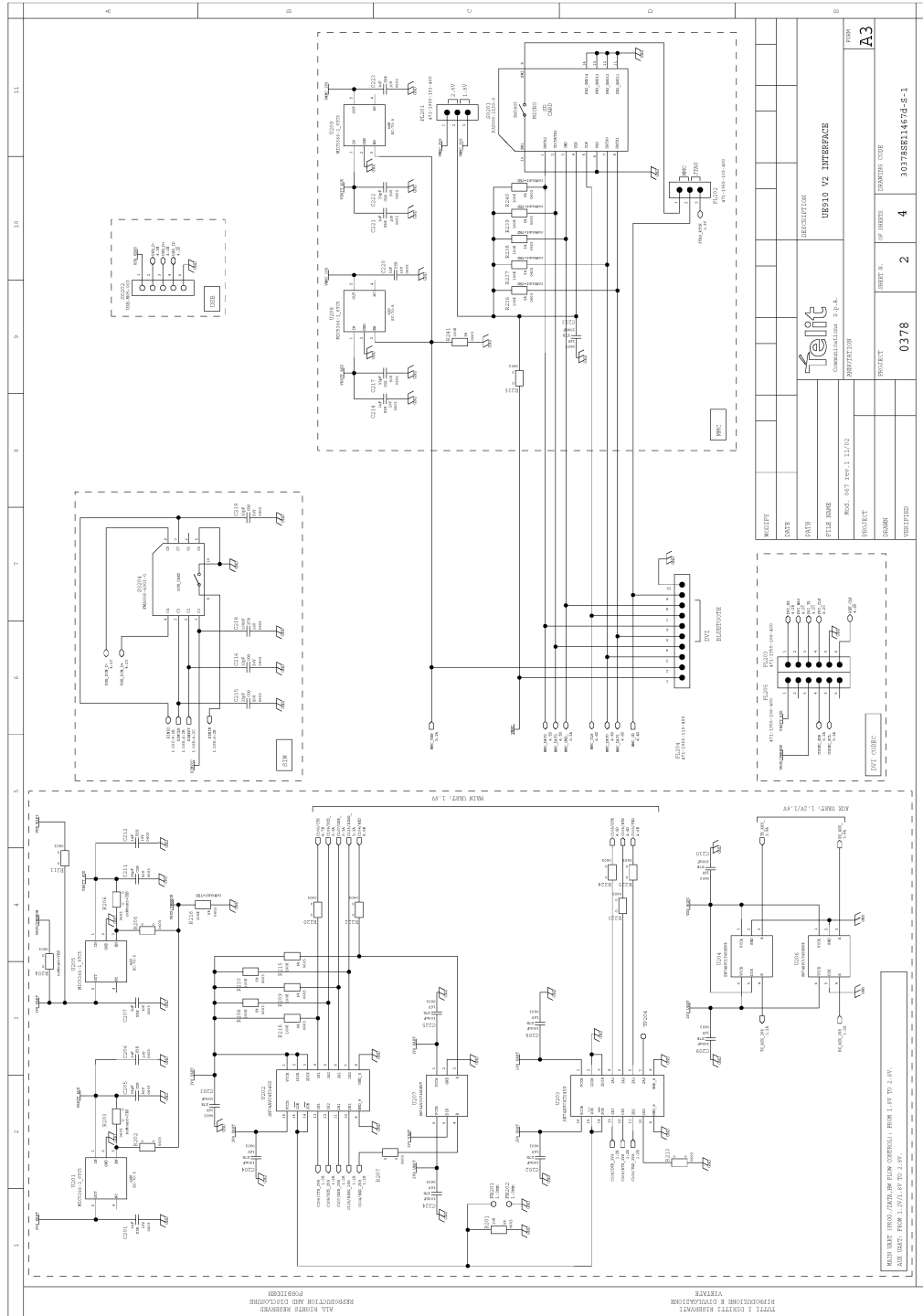

MODIFY				
DATE				
FILE NAME				
PROJECT				
DESIGNER				
REVISION				
DESCRIPTION	UR510 V2 INTERFACE			
COMPANY	Telit Communications S.p.A.			
PROJECT CODE	0378	OF SHEETS	4	SHEET NO. 2
DATE				
VERIFIED				
DESIGNED				
PRODUCT	30378RSL14674-S-1			





**Telit EVK2 User Guide**  
1w0300704 Rev.19 – 2015/01/26

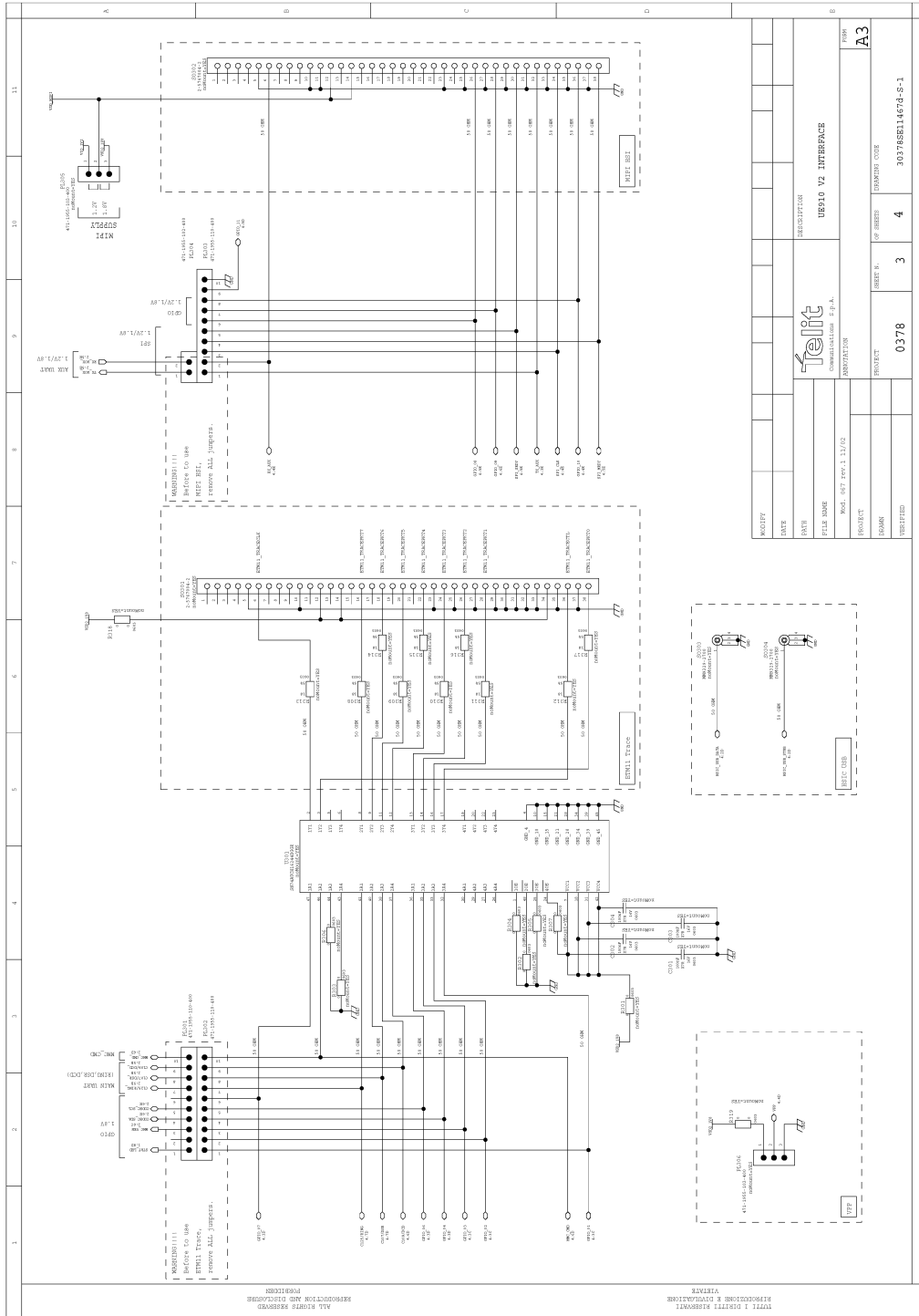

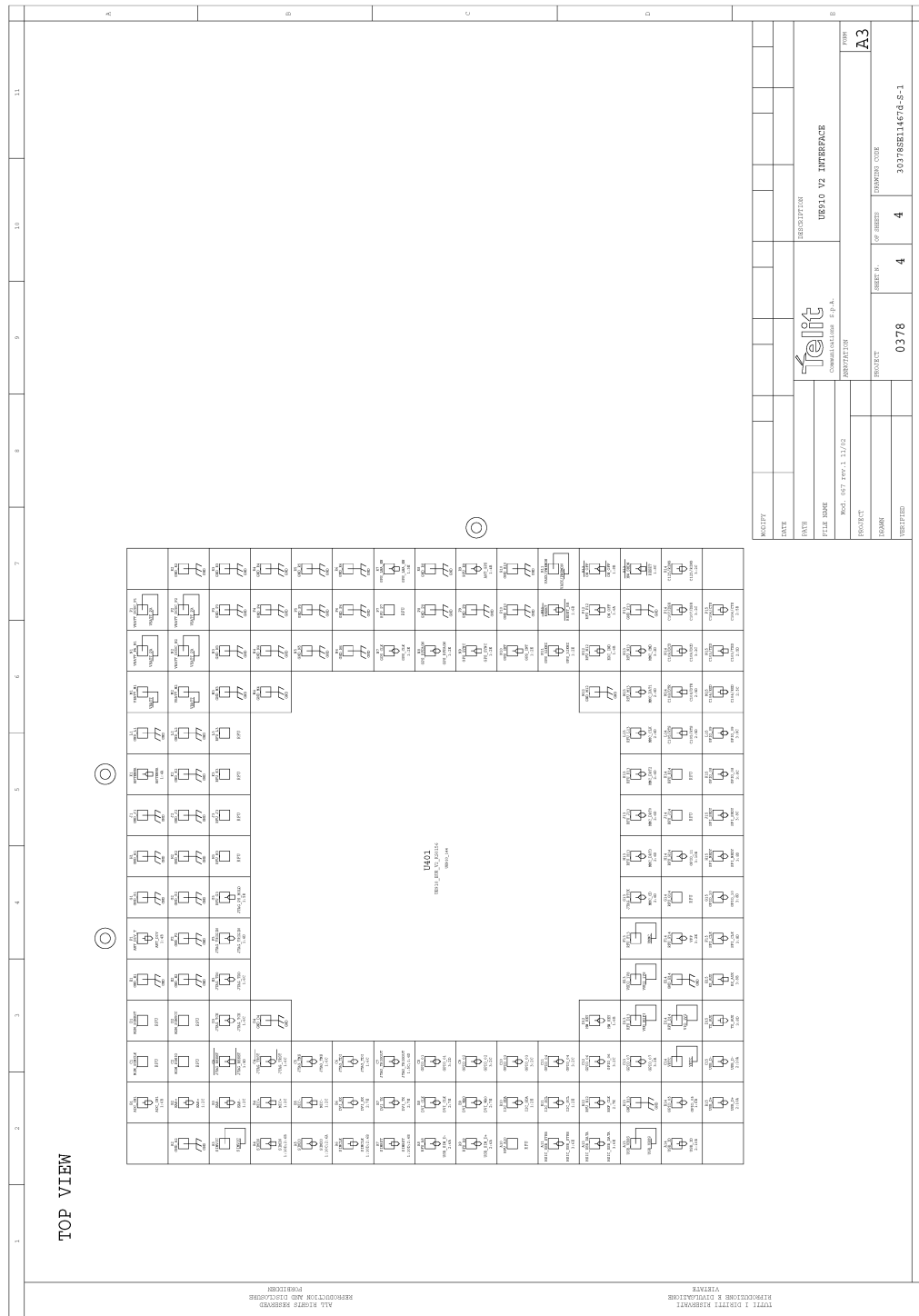

## 44.27. CL865 Interface board

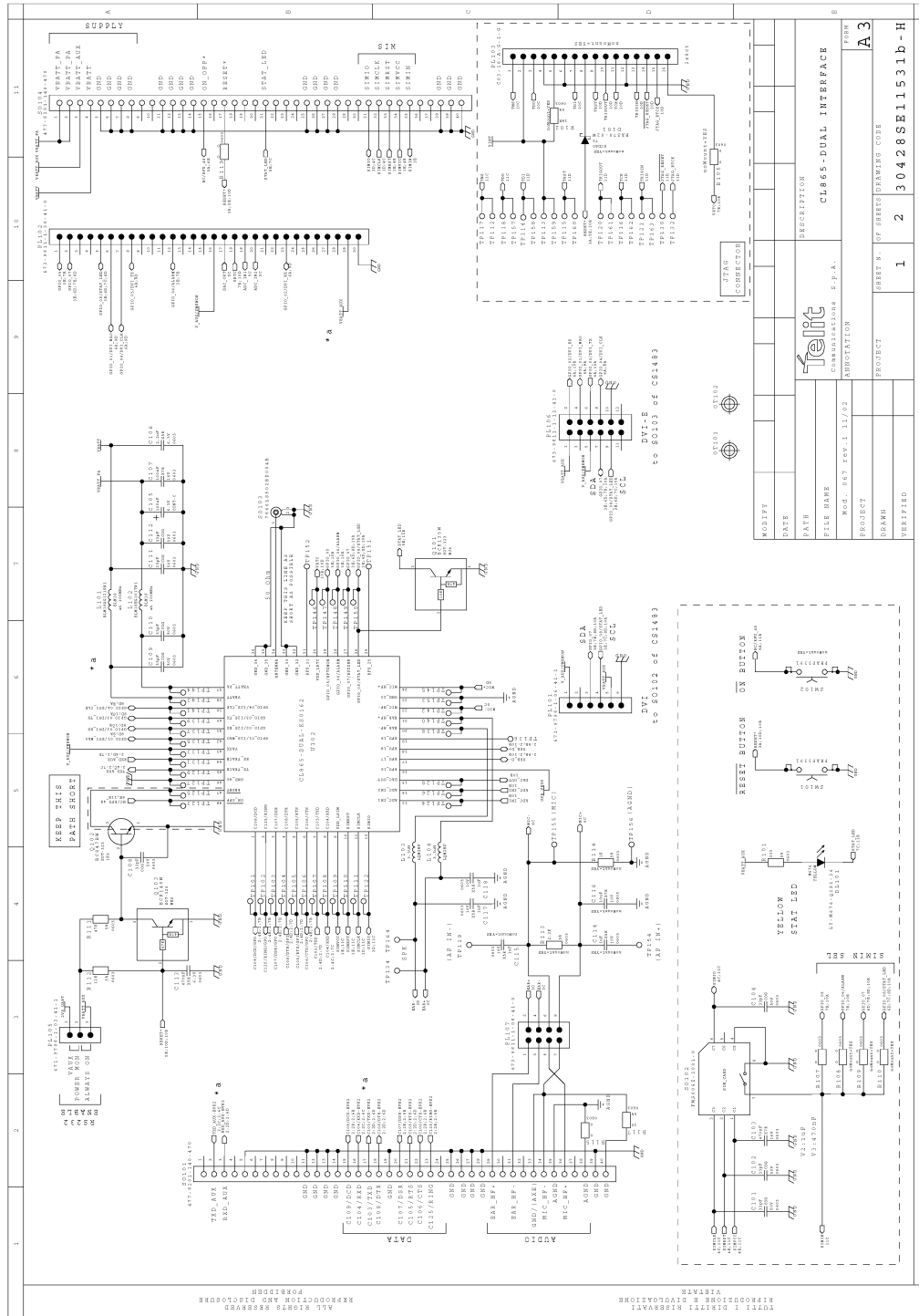

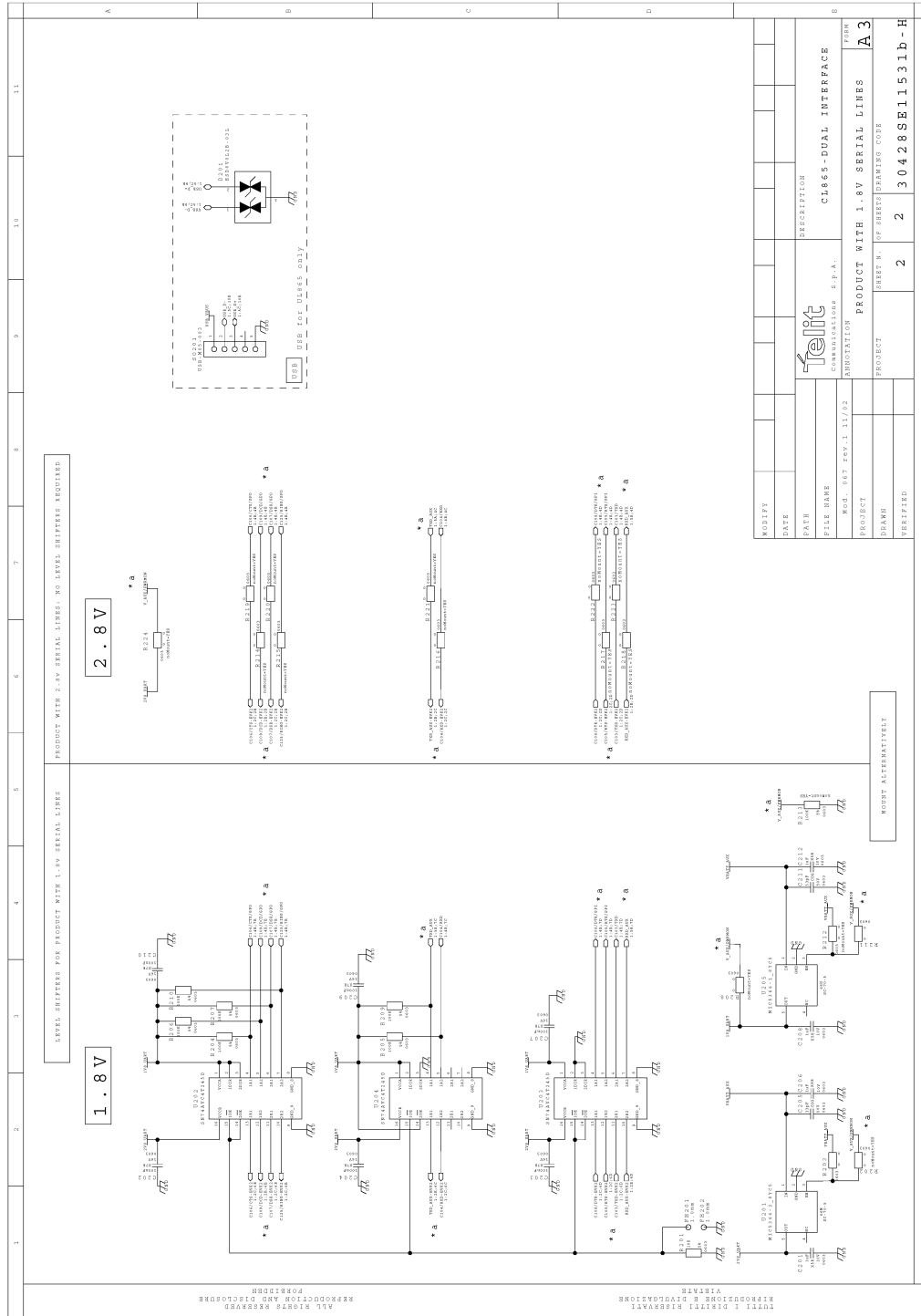

## 44.28. GE866-QUAD Interface board

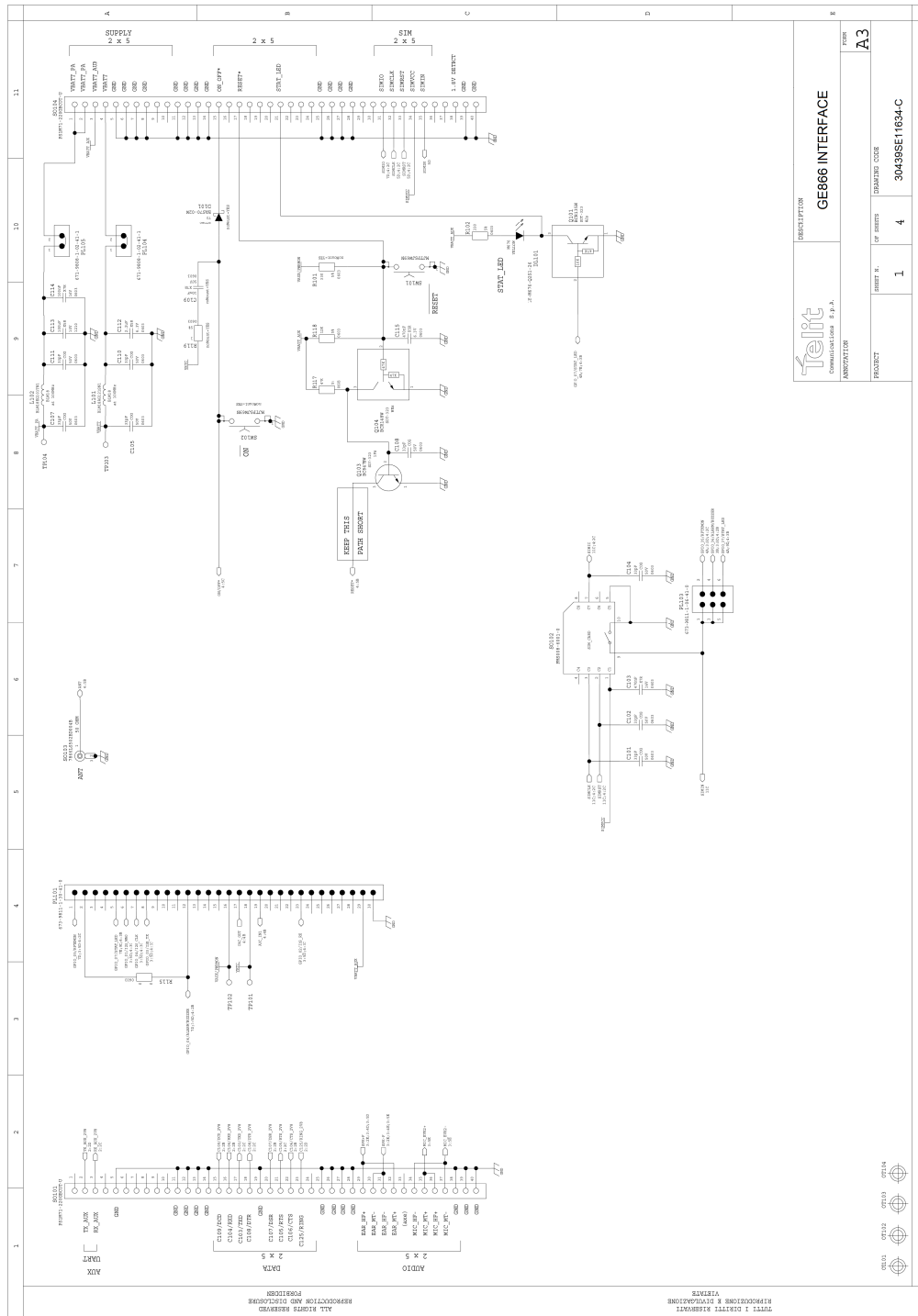



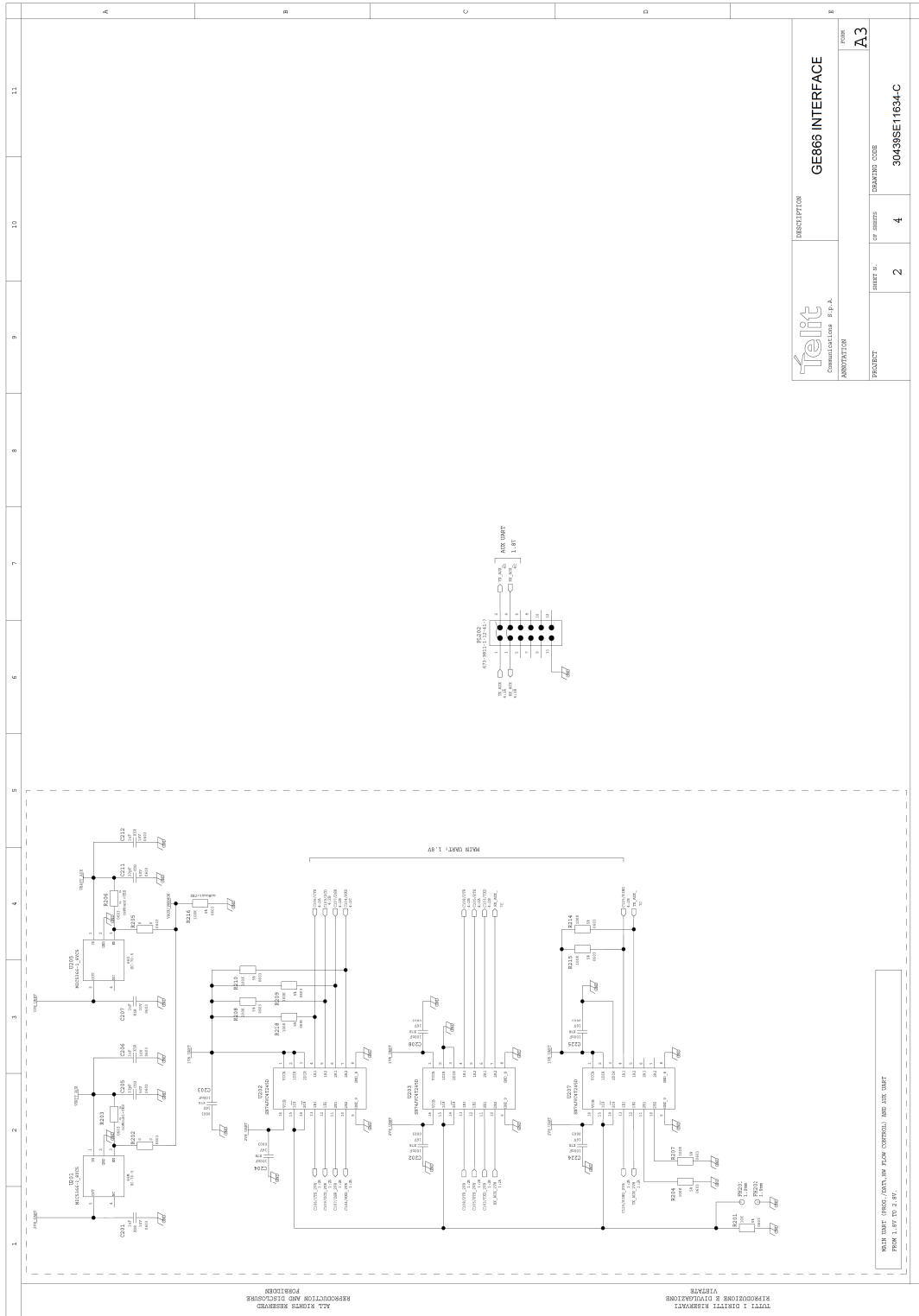

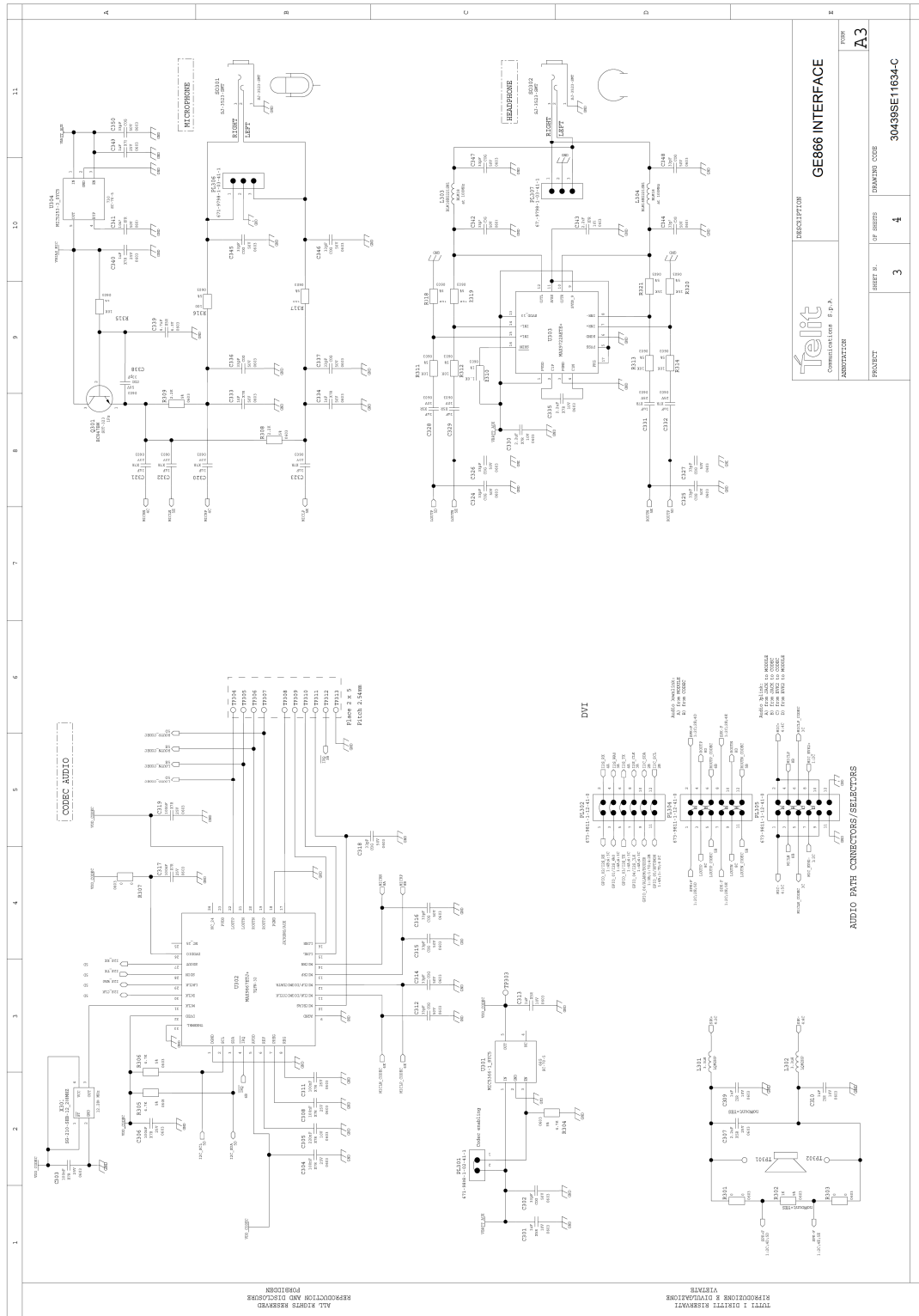

 COMMUNICATIONS S.p.A.	DESCRIPTION	GE866 INTERFACE		
	ANOTAZIONE			
PROJECT	3	4	304395E11634-C	FORM
	REV. 0001			A3



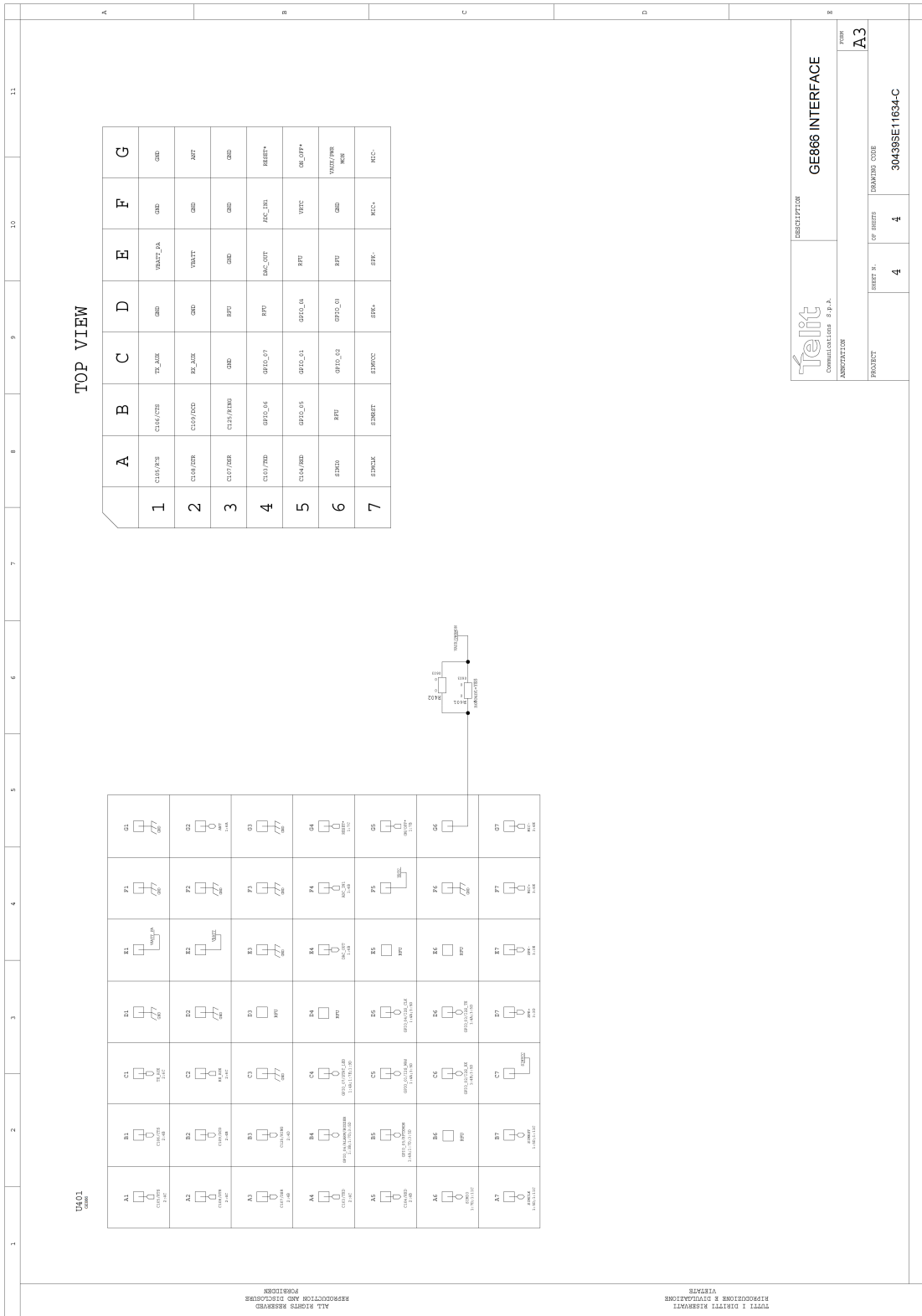

<b>Telit</b> COMMUNICATIONS S.p.A.		DESCRIPTION <b>GE866 INTERFACE</b>	
PROJECT	304395E11634-C	SHEET N.	4
OF SHEETS	4	DRAWING CODE	
FORM		<b>A3</b>	



## 44.29. UE866 Interface Board

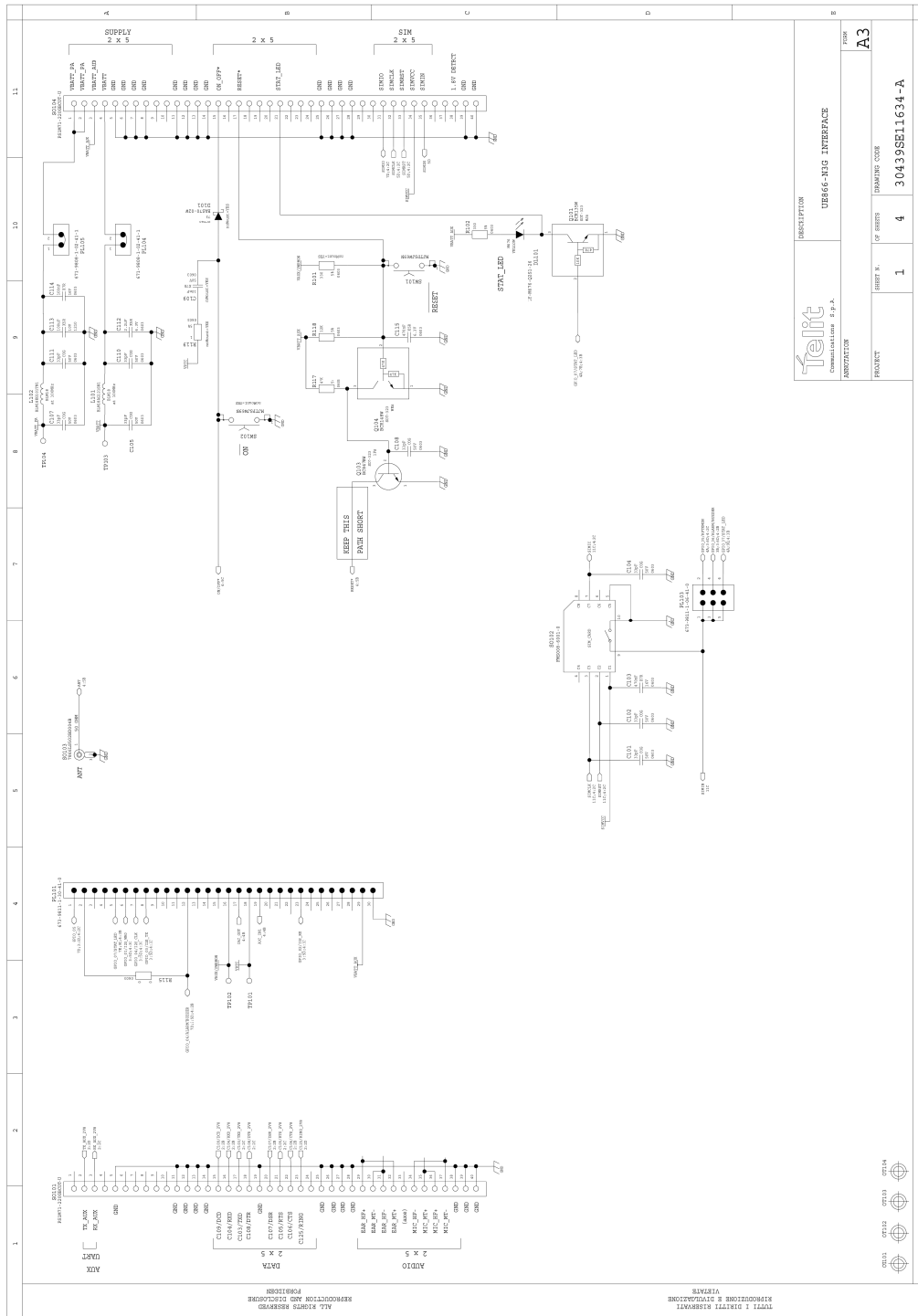

**Telit EVK2 User Guide**  
1vw0300704 Rev.19 – 2015/01/26

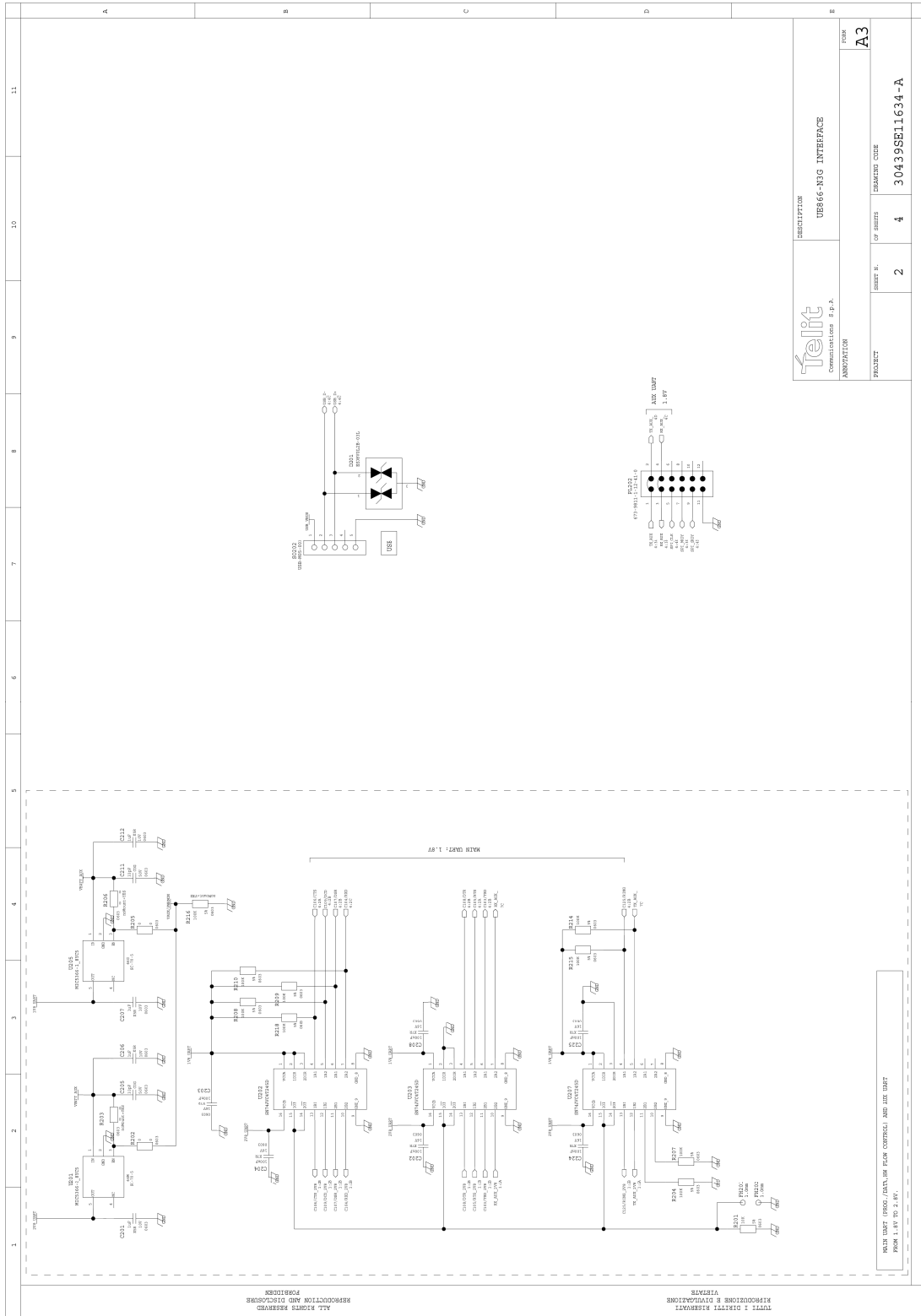



**Telit EVK2 User Guide**  
1vw0300704 Rev.19 – 2015/01/26

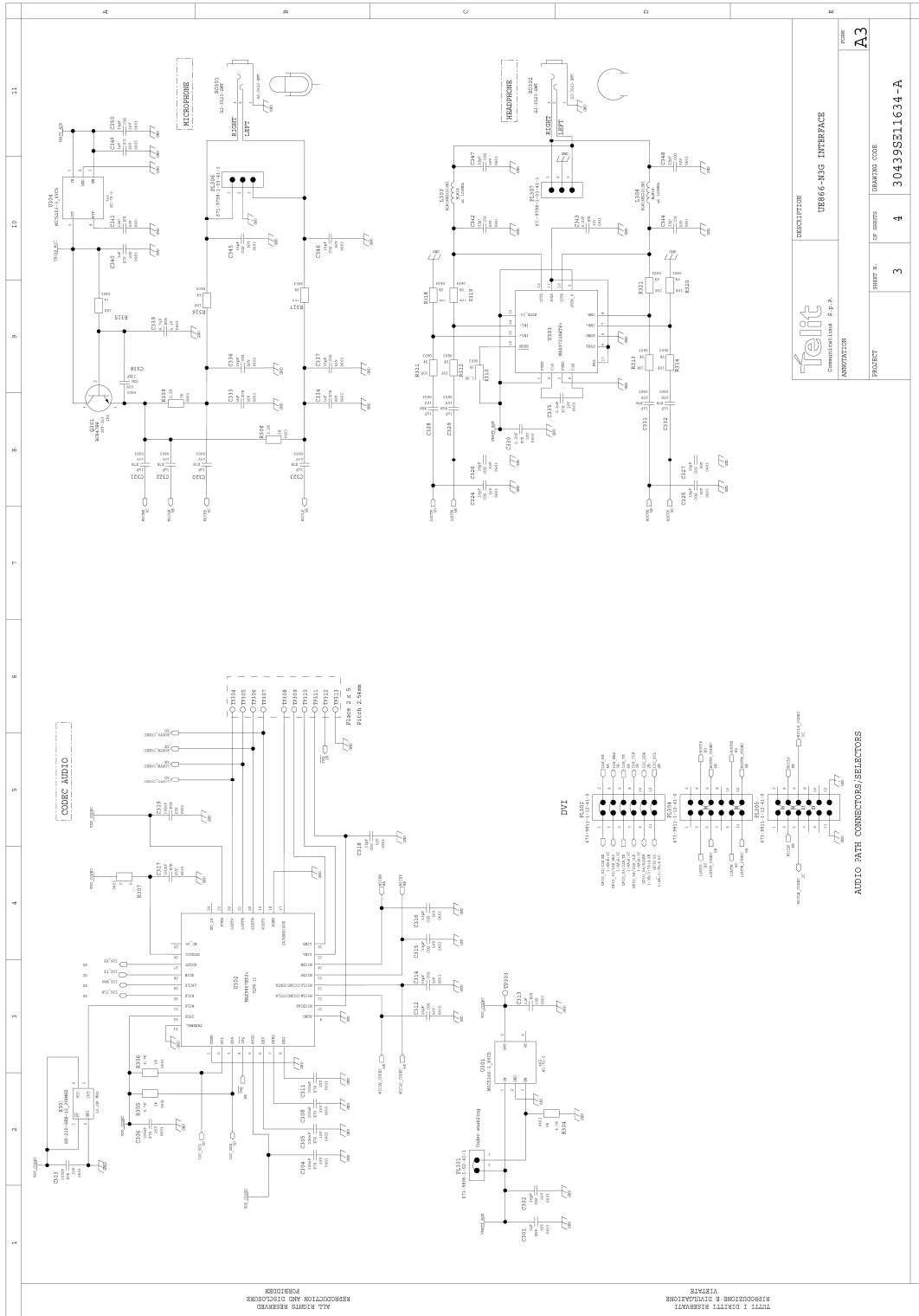

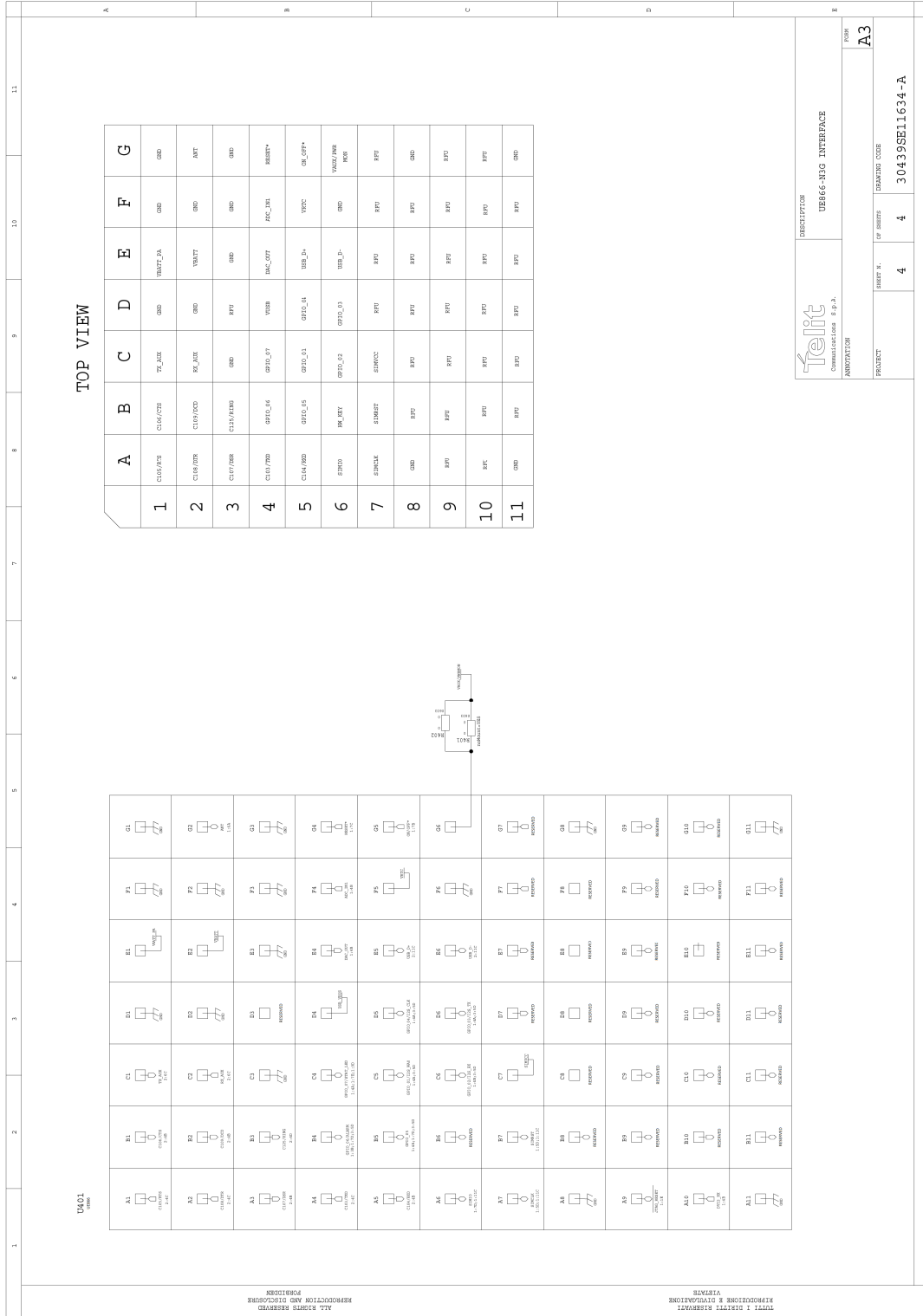

## 44.30. LE910 Interface board

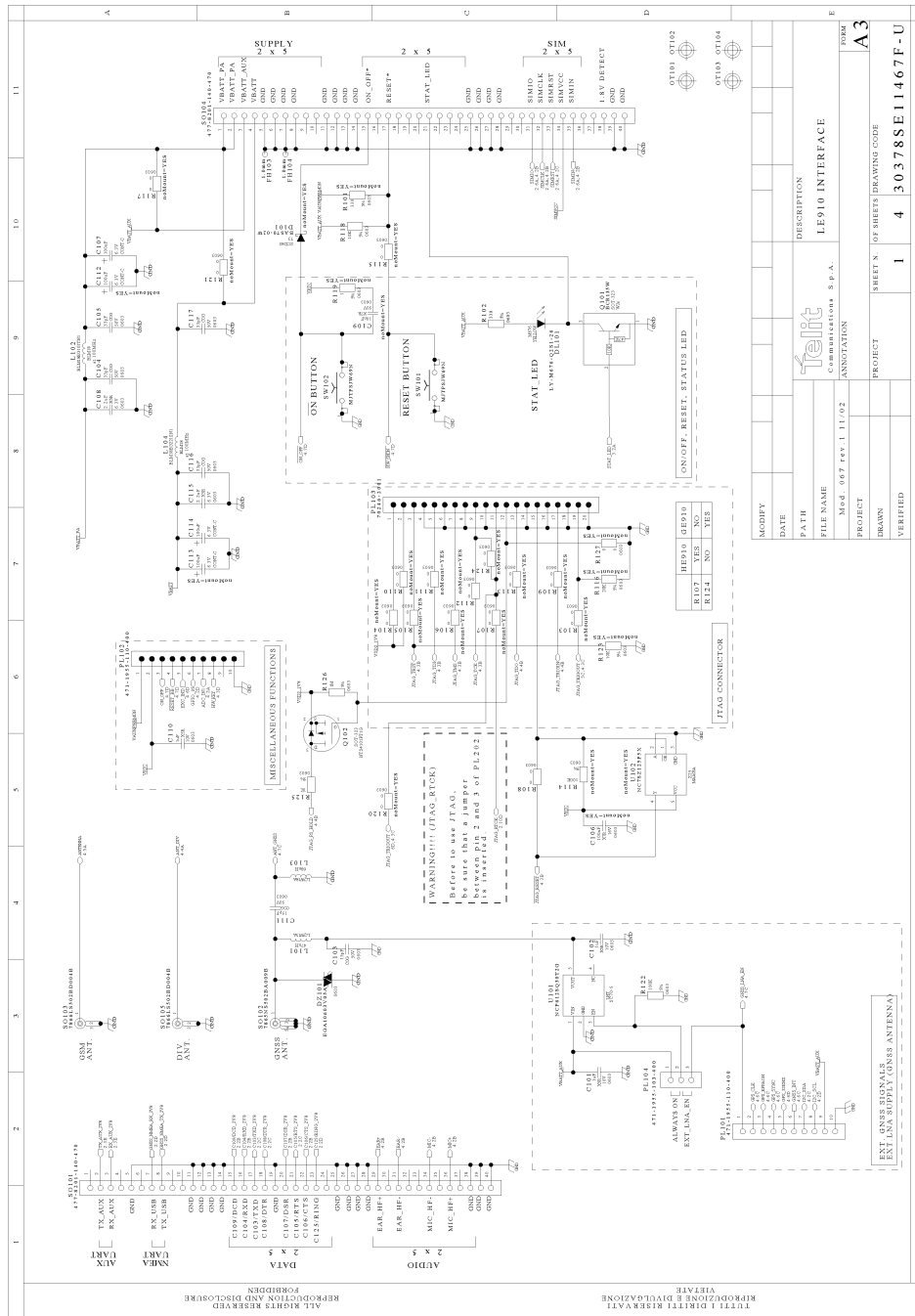

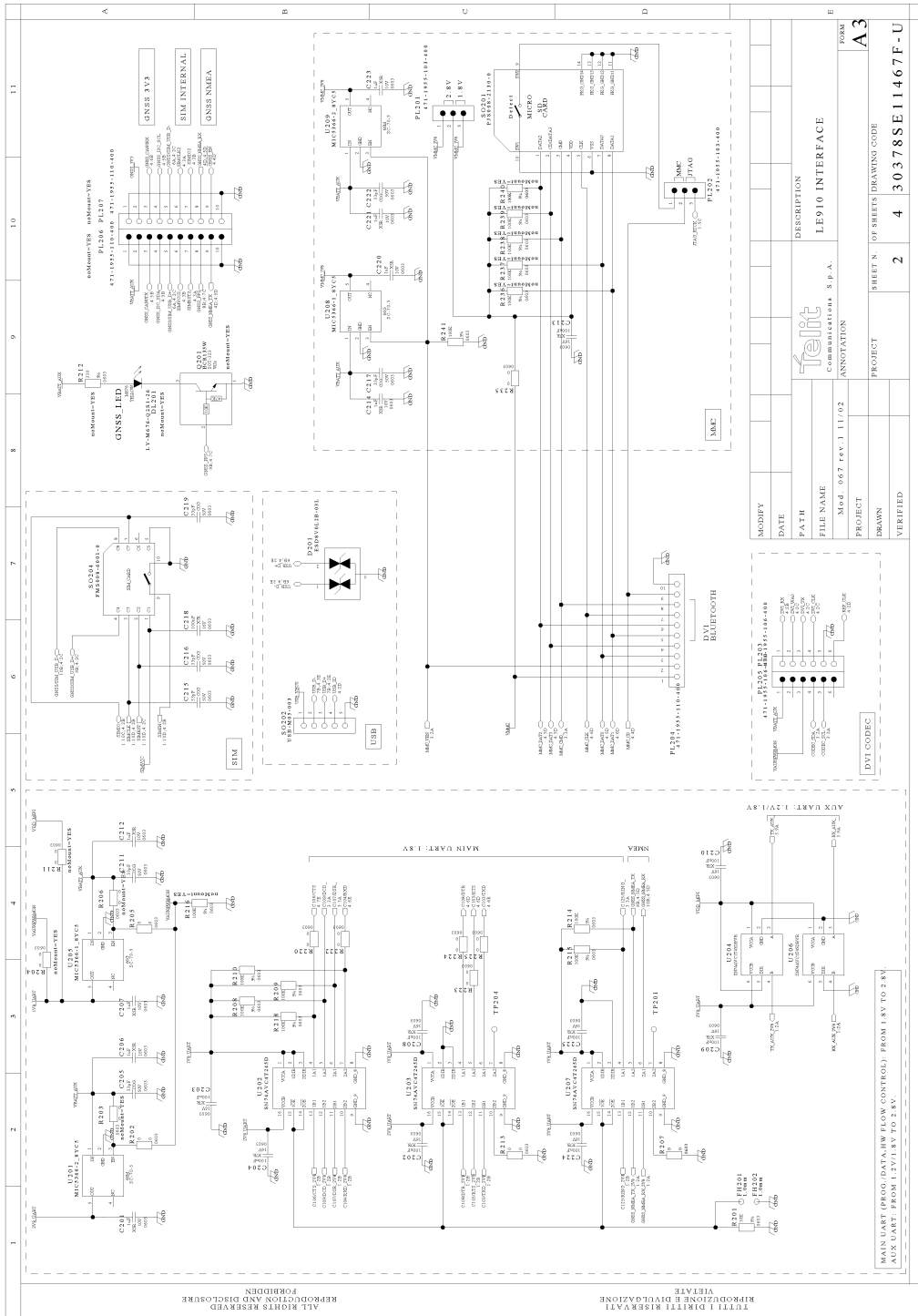

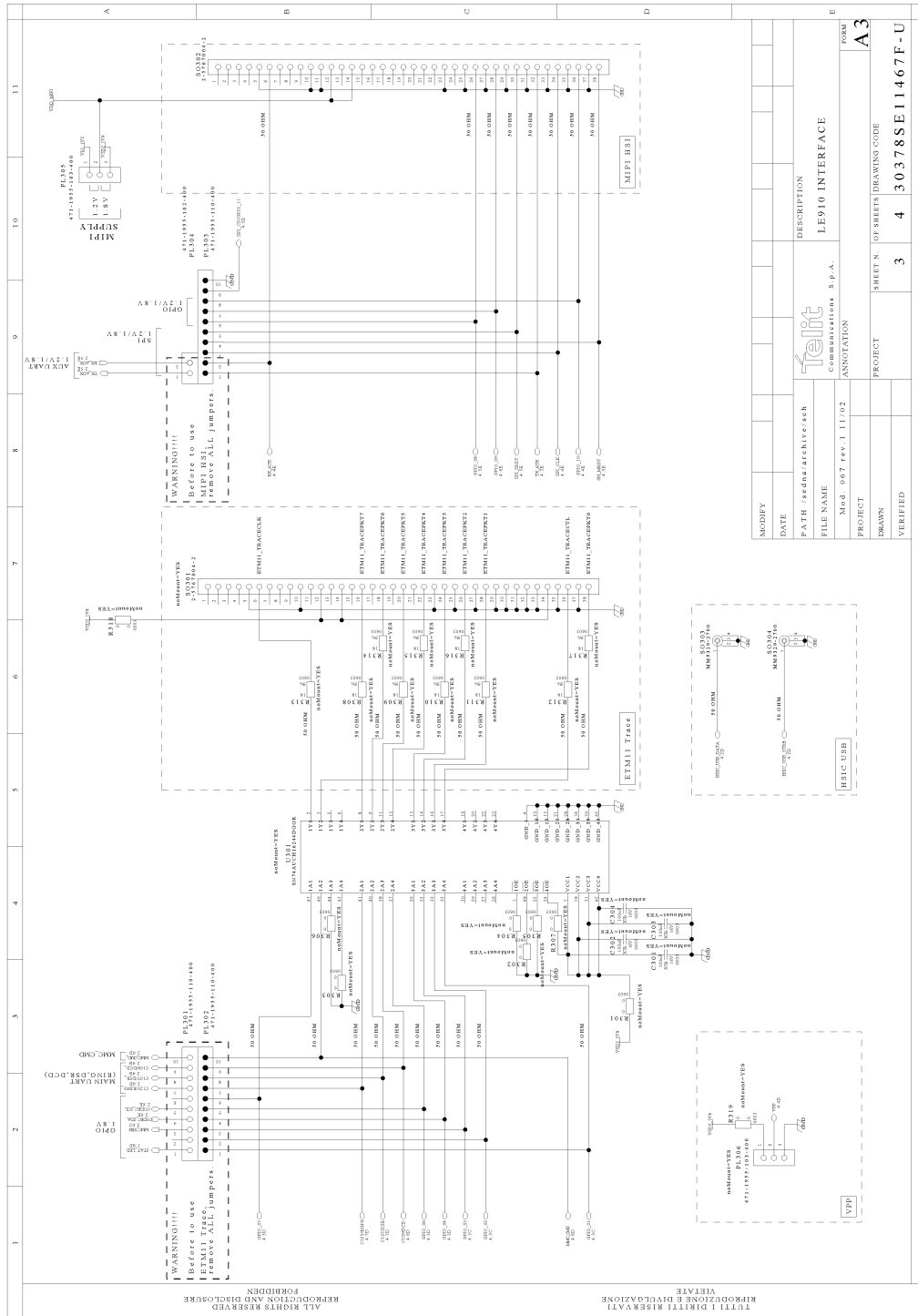



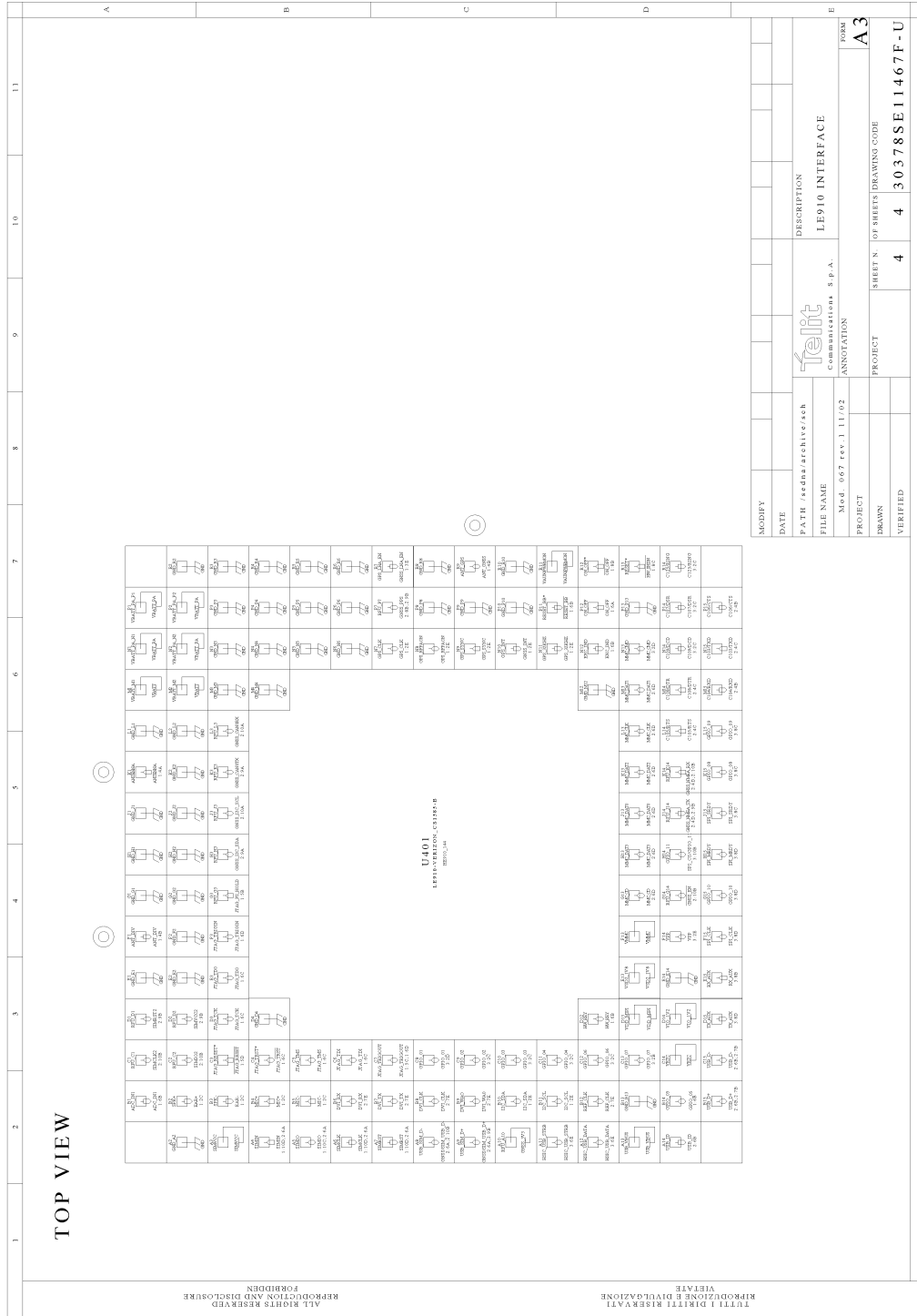

# 44.31. UL865 Interface board

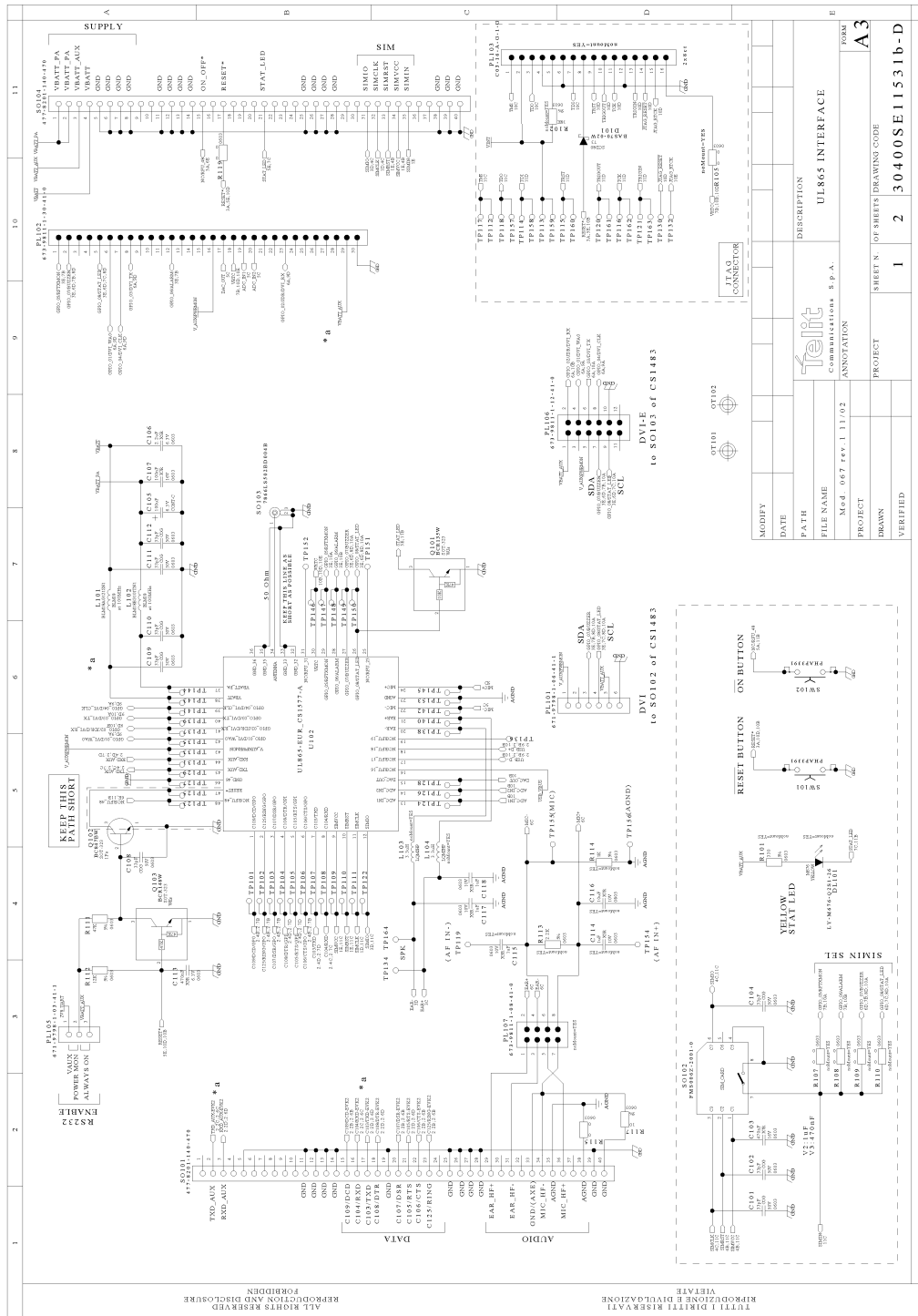

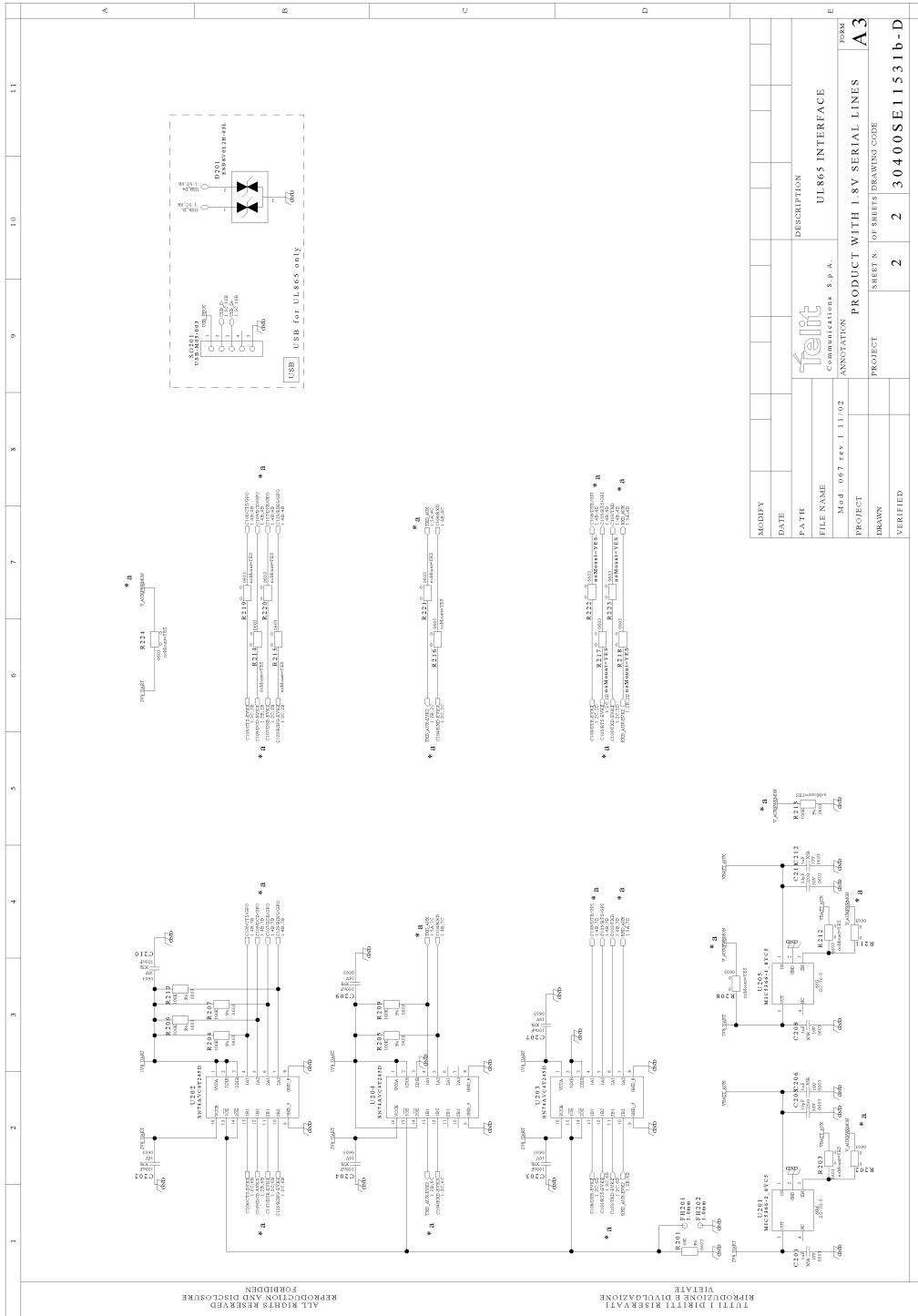

## 45. Service and firmware update

You can update the Telit Module firmware through the serial cables (RS232 or USB depending on module's characteristics) used for the communication with a PC. The firmware update can be done with a specific software tool provided by Telit that runs on windows based PCs.

All levels are conformed to RS232 and V.24 standard and a PC serial port can be directly connected to this connector.



## 46. SAFETY RECOMMENDATIONS

### READ CAREFULLY

Be sure the use of this product is allowed in the country and in the environment required. The use of this product may be dangerous and has to be avoided in the following areas:

Where it can interfere with other electronic devices in environments such as hospitals, airports, aircrafts, etc

Where there is risk of explosion such as gasoline stations, oil refineries, etc

It is responsibility of the user to enforce the country regulation and the specific environment regulation.

Do not disassemble the product; any mark of tampering will compromise the warranty validity.

We recommend following the instructions of the hardware user guides for a correct wiring of the product. The product has to be supplied with a stabilized voltage source and the wiring has to be conforming to the security and fire prevention regulations.

The product has to be handled with care, avoiding any contact with the pins because electrostatic discharges may damage the product itself. Same cautions have to be taken for the SIM, checking carefully the instruction for its use. Do not insert or remove the SIM when the product is in power saving mode.

The system integrator is responsible of the functioning of the final product; therefore, care has to be taken to the external components of the module, as well as of any project or installation issue, because the risk of disturbing the GSM network or external devices or having impact on the security. Should there be any doubt, please refer to the technical documentation and the regulations in force.

Every module has to be equipped with a proper antenna with specific characteristics. The antenna has to be installed with care in order to avoid any interference with other electronic devices and has to guarantee a minimum distance from the people (20 cm). In case of this requirement cannot be satisfied, the system integrator has to assess the final product against the SAR regulation.

The European Community provides some Directives for the electronic equipment introduced on the market. All the relevant information's are available on the European Community website: <http://europa.eu.int/comm/enterprise/rte/dir99-5.htm>

The text of the Directive 99/05 regarding telecommunication equipments is available, while the applicable Directives (Low Voltage and EMC) are available at: [http://europa.eu.int/comm/enterprise/electr\\_equipement/index\\_en.htm](http://europa.eu.int/comm/enterprise/electr_equipement/index_en.htm)





## 46.1. Disposal of this product in the European Union

According to the WEEE Directive 2012/19/EU, the crossed-out wheeled bin symbol on the product or on its packaging indicates that the product must not be disposed of with your other household waste.



For equipment in private household, it's user's responsibility to dispose of his waste equipment by handing it over to a designated collection point for the recycling of waste electrical and electronic equipment. For more information about where you can drop off your waste equipment from private household for recycling, please contact your local city office, your household waste disposal service or the retailer where you purchased the product. As a producer of electronic devices, TELIT provides for the financing of the treatment and recycling of waste returned through the designated collection points in accordance with local requirements. If you have professional electronic equipment that you purchased directly from TELIT that you wish to have picked up for recycling, please contact us to receive necessary information and instructions. The separate collection and recycling of your waste equipment at the time of disposal will help to conserve natural resources and ensure that it is recycled in a manner that protects human health and the environment.

Reference Directives:

2012/19/EU	Directive of the European Parliament and of the Council of 4 July 2012 on waste electrical and electronic equipment (WEEE).
------------	---

## 46.2. Disposal of this product in other countries outside the European Union

Please dispose of this product in accordance with local requirements; contact your local authorities or dealer and ask for the correct method of disposal.





Rev.5	13/10/2006	<p>Renamed figure from 38 to 42</p> <p>Pag.2 Added products name and P/N for GE863-PY/QUAD interface and GC864-C2 interface</p> <p>3.2.6 Added mechanical characteristics GC864-C2 interface</p> <p>5.0 Correct Optically Positioning Guide system description</p> <p>7.1 Correct the line selection description</p> <p>6.5.2 Updated Current Charger footnote</p> <p>Generality: added note for the VGA camera</p> <p>Added in the Cross List GE864-PY/QUAD interface and GC864-C2 interface</p> <p>15.2.1 Inserted P/N of GE863-GPS version</p> <p>Added GC864-C2 interface description</p> <p>20.1 Corrected GPIO location and added p/n of GM862 interface</p> <p>20.2 Corrected GPIO location and added p/n of GE863-GPS interface</p> <p>Corrected GPIO location and added p/n of GE863 interface</p> <p>Corrected GPIO location and added p/n of GE864 interface</p> <p>Corrected GPIO location and added p/n of GC864 interface</p> <p>Corrected GPIO location and added p/n of GC864-C2 interface</p> <p>Added GC864-C2 interface Schematic</p> <p>GM862 Interface p/n 3990250670: added RoHS certification</p> <p>GE863-PY Interface p/n 3990250669: added RoHS certification</p> <p>GE863-GPS Interface p/n 3990250671: added RoHS certification</p> <p>GE863-PY Interface p/n 3990250684: added RoHS certification</p> <p>GC864-QUAD Interface p/n 3990250685: added RoHS certification</p> <p>GE864-PY Interface p/n 3990250672: added RoHS certification</p> <p>GC864-PY Interface p/n 3990250680: added RoHS certification</p>
Rev.6	24/05/2007	<p>Pag.2 Product Table updated</p> <p>Pag.10 Table 1 updated</p> <p>Pag.24 Modified the formula</p> <p>Pag.22 Inserted the Audio Section chapter</p> <p>Pag.39 Table 10 modified</p> <p>PCB release updating</p> <p>Erased all Dual Camera paragraph</p> <p>Figures and table updated</p> <p>Paragraph 15.3 16.2 17.3 18.3 19.3 inserted</p> <p>24.1 EVK2 SYS p/n 3990150463: added RoHS certification</p> <p>24.9 GE864-QUAD Interface p/n 3990250688: added RoHS certification</p> <p>24.11 GE864-QUAD-C2 Interface p/n 3990250683: added RoHS certification</p>



## Telit EVK2 User Guide

1wv0300704 Rev.19 – 2015/01/26

Rev.7	22/01/2008	<p>Pag.2 Product Table updated with UC864-E and GE863-SIM</p> <p>Pag.7 Disclaimer Date modified</p> <p>Pag.13 Inserted UC864 Interface dimensions</p> <p>Pag.36 Inserted refer to GE863-SIM</p> <p>Pag.38 Table 10 Inserted UC864 and GE863-SIM Interface Code</p> <p>Pag.38 Order Code Table updated</p> <p>Pag.42 Added figure 24 with GE863-SIM photo</p> <p>Pag.43 Added GE863-SIM version kit list</p> <p>Pag.54 Inserted UC864 Interface photo</p> <p>Pag.64 Inserted figure 40 and Table 17 of UC864 GPIO positioning</p> <p>Pag.77-78 Inserted UC864 Interface Schematic diagrams</p> <p>Removed notes regarding interface board of phased out models from the GE863 family (Please refer to the previous version of this document if you need information for the interfaces with the following P/N: 3990250669 &amp; 3990250677)</p>
Rev.8	20/03/2008	<p>Pag.64 Updated 40 and Table 19 of UC864 GPIO positioning</p> <p>Pag.66-70 Updated EVK mother board schematics</p> <p>Pag.81 Added new European WEEE directive</p>
Rev. 9	28/05/2008	<p>Pag.77-78 Replaced UC864 Interface board schematics with more readable drawings.</p>
Rev. 10	20/06/2011	<p>Pag.02 Replaced the applicability list – Pag.123 replaced the RoHS certifications</p>
Rev. 11	18/07/2011	<p>HE910 added to the document</p> <p>GE864-GPS section update to align with latest PCB development</p>
Rev. 12	2012/05/21	<p>Added GE865-JF2 sections</p>
Rev. 13	2012/06/25	<p>Updated fig.48</p> <p>Updated HE910 interface board P/N in applicability Table.</p> <p>Update GE865+JF2 drawings §27.1</p>
Rev. 14	2012/12/11	<p>Updated with GE910 interface board; P/N in applicability Table.</p> <p>Updated Startup procedure chapter with XX910 products and timings;</p> <p>Updated Power ON Switch chapter with XX910 products and timings;</p> <p>Updated Figure 22 Switches position</p> <p>Added info for DE910 and CE910</p> <p>20 2.2.15 DE910 Interface CS1467D</p> <p>20 2.2.16 CE910 Interface CS1467D</p> <p>27 DE910 family Interface</p> <p>28 CE910 family Interface</p> <p>29.1.12 DE910 Interface</p> <p>29.1.13 CE910 Interface</p> <p>30.17 DE910 Interface board schematic</p> <p>30.18 CE910 Interface board schematic</p>
Rev. 15	2013-02-19	<p>Added §20 about JN3+GL865 Interface board.</p>
Rev. 16	2013/03/15	<p>Added GL865 V3 interface board</p>
Rev. 17	2013/05/30	<p>Added GE910-GNSS; GE910-QUAD V3, UE910, LE920 interface board</p>
Rev. 18	2014/06/30	<p>Added HE920, HE910 V2, UE910 V2, CL865, UL865 and LE910 interface boards</p> <p>Updated 45.1 Disposal of product in the European Union</p> <p>Added 45.2 Disposal of product outside the European Union</p>
Rev. 19	2015/01/26	<p>Updated chapters 39 and 44.28: GE866-QUAD Interface</p> <p>42.1.20 GPIO Table</p> <p>Added UE866 and UE910 3G</p>







## X-ON Electronics

Largest Supplier of Electrical and Electronic Components

*Click to view similar products for [USB Interface IC](#) category:*

*Click to view products by [Telit](#) manufacturer:*

Other Similar products are found below :

[TUSB1146RNQT](#) [TUSB1146IRNQT](#) [CY7C65210-24LTXI](#) [CY7C69356-48LTXC](#) [CYUSB2304-68LTXI](#) [CY7C65642-48AXCT](#) [CYPD2119-24LQXI](#) [USB2227-NU-11](#) [USB2251-NU-06](#) [USB3319C-GJ-TR](#) [USB3370B-EZK-TR](#) [USB5537B-4100AKZE](#) [USB3347-CP](#) [USB2230-NU-02](#) [USB2229-NU-02](#) [CG7648AM](#) [W83627HG-AW](#) [CY7C64225-28PVXCT](#) [CY7C65215A-32LTXI](#) [CYPD2120-24LQXI](#) [CYWB0164BB-BZXI](#) [CYWB0224ABS-BZXI](#) [CY7C65211A-24LTXI](#) [USB5807T-I/KD](#) [USB5742-I/2G](#) [USB3331E-GL-TR](#) [USB3321C-GL-TR](#) [USB1T1103MHX](#) [USB1T1103MPX](#) [USB5742/2G](#) [MAX3301EETJ+T](#) [CYPD2122-20FNXIT](#) [CYPD2122-24LQXIT](#) [LIF-UC120-SWG36ITR50](#) [MAX3456EETE+T](#) [LIF-UC120-CM36ITR50](#) [UPD360-C/6HX](#) [USB2228-NU-11](#) [UPD360-B/6HX](#) [PI3EQX7841ZDEX](#) [CYPD4225-40LQXI](#) [LAN7800-I/VSX](#) [UPD360T-B/6HX](#) [UPD360-A/6HX](#) [LAN7800/VSX](#) [MAX20037ATIB/V+](#) [MP5030CGQH-P](#) [USB7056/KDX](#) [STUSBCD01BJR](#) [CY7C65642-28LTXCT](#)