

## Thick-film power resistor RTS-02

### Characteristics



### Description

RTS series high power resistors are made in a thick film technology on stainless steel substrate. Resistors are characterized by a high power at small size, high resistance to temporary overloads and very low inductance which make them useful at high power and high frequency applications. Mounting holes dimensions are compliant with standard thick film heat-sinkable power resistors, which allows for an easy replacement. Various types of connectors are available, in standard resistors are equipped with 5/A screw connectors. Resistors are designed for use with suitable heatsink.

### Features

- Very good power/volume ratio
- Power applications up to 1000W
- Wide ohmic range
- Flat design
- Non inductive
- Easy mounting
- RoHS compliant



### Technical Specifications

	RTS-02-300	RTS-02-600
Resistance range	0,1 Ω ... 1 MΩ (available also < 0,1 Ω)	
Resistance tolerance	±5%, ±10 %	
Power rating (on heatsink)	300 W	600 W
Electric strength voltage	2,5 kV	
Temperature coefficient	±100 ppm/°C (available also ±1500 ppm/°C )	
Max operating temperature	170°C (available also 300°C )	
External dimensions	67 x 60 x 2 mm	
Mounting - torque for contacts M4	1,6 Nm ... 1,8 Nm	

Contact technical department for more informations.

## Thick-film power resistor RTS-02

### Thermal resistance

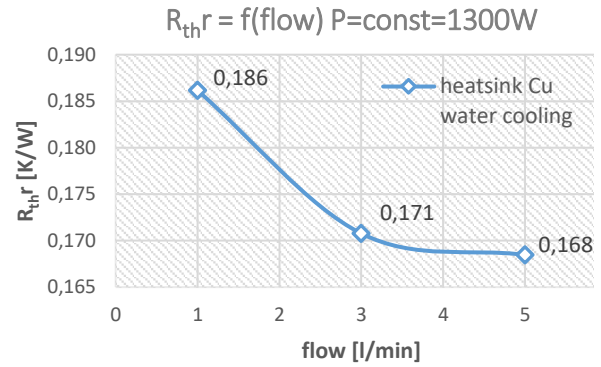
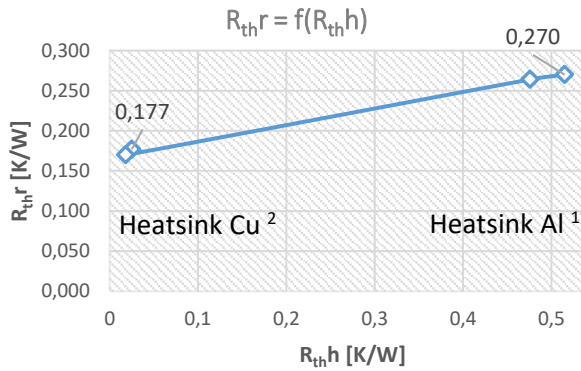

$R_{th,r}$  – Thermal resistance of the RTS-02 resistor  
 $R_{th,h}$  – Thermal resistance of the heatsink

### Temperatures on resistor with different working conditions

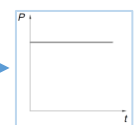
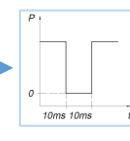
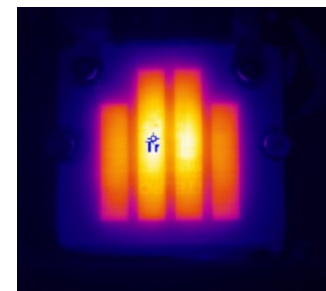
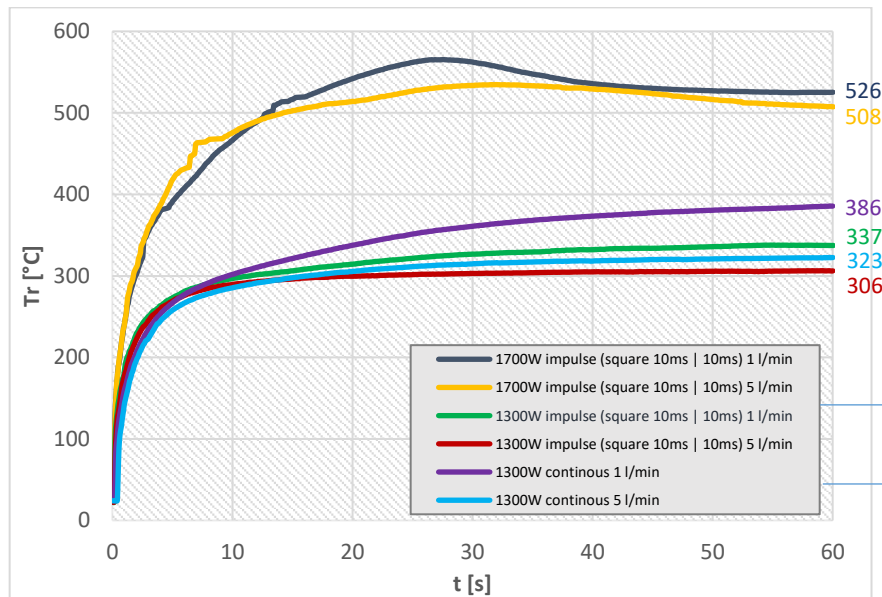

$T_r$  – Temperature on resistor surface, Heatsink Cu<sup>2</sup> (water 21 °C), AAB TG4 thermal grease, 1,6 Nm mounting screws

### Overload

Every test resistor was mounted with thermal grease (AAB TG4) on a heatsink Cu<sup>2</sup>

- Constant inlet water temperature: +20°C (flow 0,5l/min)
- Pulse lenght:  $t_1 = 200\text{ms}; 600\text{ms}; 1\text{s}; 5\text{s}; 10\text{s}$
- Pulse shape: rectangular
- Break time between pulses: 30s
- Test time: 10min

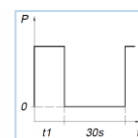

## Thick-film power resistor RTS-02

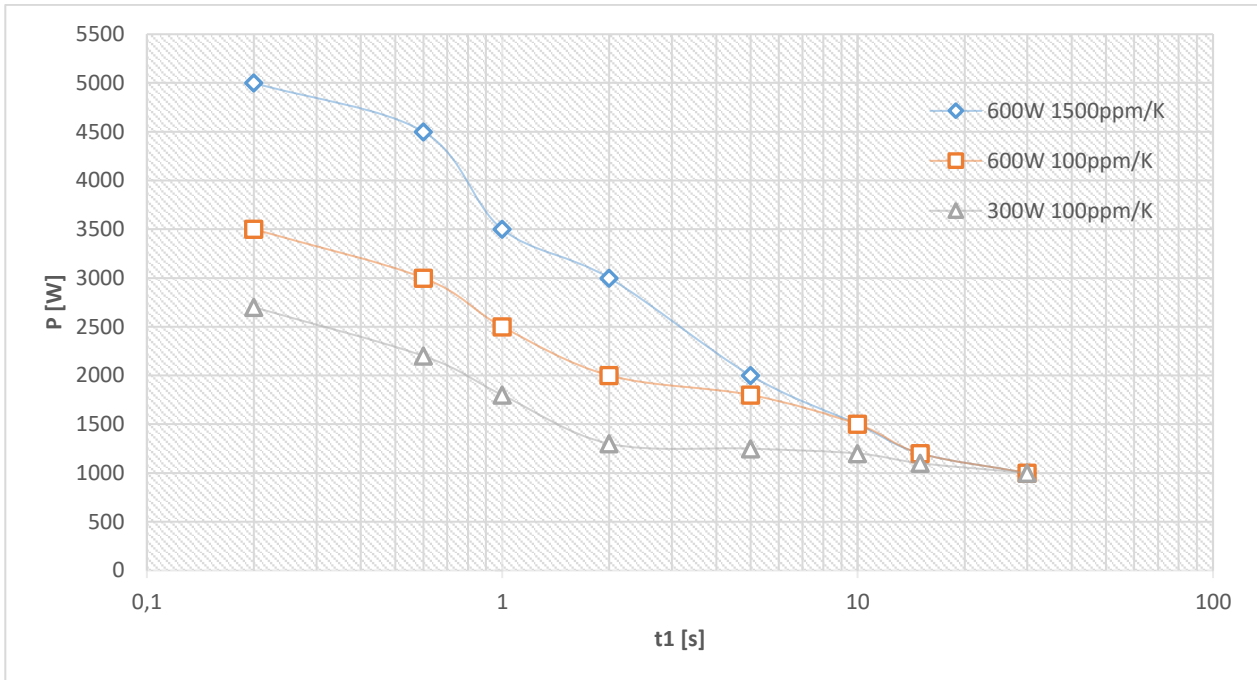

Do you need to check the resistor in your application ? Contact us for custom measurements / samples.

### Used heatsinks

<sup>1</sup> Heatsink Al – 202x70x70mm, 62cm<sup>2</sup> cross section,  
R<sub>th,h</sub>=0,48 K/W (no air-cooling)

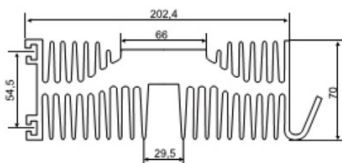

<sup>2</sup> Heatsink Cu – 195x150x26 with water cooling,  
R<sub>th,h</sub>=0,025 K/W (1 l/min, 21 °C)

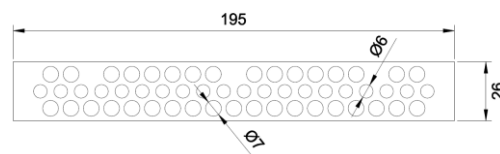

### External dimensions

[mm]

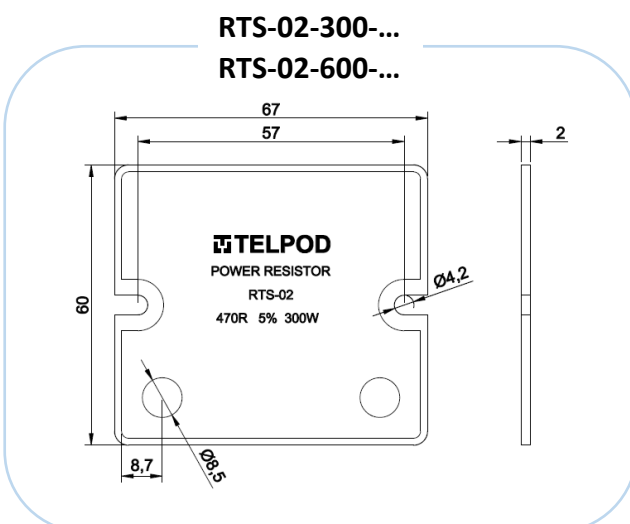

## Thick-film power resistor RTS-02

### Types of terminals

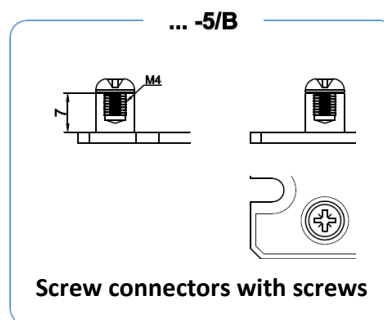
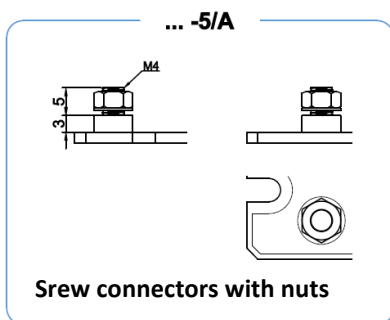
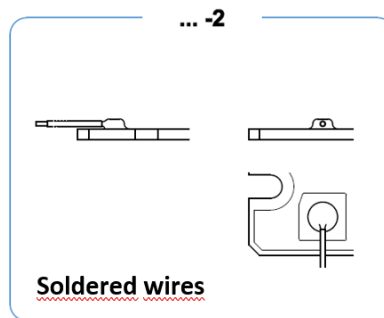
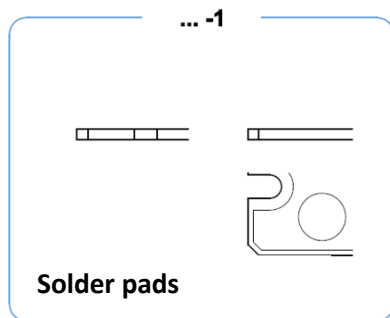

The recommended tightening torque for 5/A and 5/B connections is **1.2 Nm**

### Mounting to the heat sink

The resistor should be screwed to the heat sink with M4 screws. In order to ensure effective heat transfer, we recommend using thermocouples dedicated specifically to our products. More information on [RTS-THERMOPADS](#).

### Ordering informations

Series	-	Power	-	Resistance	-	Tolerance	-	Terminal
RTS-02		300 W 600 W		0R1 ... ... 1M		5 % 10 %		1 2 5/A 5/B

### Example

**RTS-02 - 300 - 1R - 5 - 5/A**

RTS-02 series resistor with power 300W, resistance  $1\Omega \pm 5\%$  with screws and nut connections.

#### TELPOD S.A.

Pilsudskiego 63A  
32-050 Skawina  
www.telpod.pl

#### Sales Division

Tel.: +48 (0)12 257 10 35  
Fax: +48 (0)12 257 10 13  
order@telpod.pl

#### Technical Division

Tel.: +48 (0)12 257 10 12  
thickfilm@telpod.pl

## X-ON Electronics

Largest Supplier of Electrical and Electronic Components

*Click to view similar products for [Wirewound Resistors - SMD category](#):*

*Click to view products by [Telpod manufacturer](#):*

Other Similar products are found below :

[RWS5 R22 F B](#) [S-2 22 OHM 1%](#) [S-2 47 OHM 1%](#) [S-2 680 OHM 1%](#) [S-2 68 OHM 1%](#) [S-3 100 OHM 1%](#) [S-3 22000 OHM 1%](#) [S-4 0.010 OHM 1%](#) [S-4 220 OHM 1%](#) [S-4 22 OHM 1%](#) [S-4 470 OHM 1%](#) [S-4 68 OHM 1%](#) [WSM24R99FLFTR](#) [SMW3300RJT](#) [RWS5 33R J B](#)  
[RWS1 50R F B](#) [PWR4318W1001JE](#) [PWR2010WR500FE](#) [6-1676966-7](#) [2-1879233-9](#) [8-1879233-4](#) [1879233-1](#) [1-1879233-3](#)  
[0480100/7660087](#) [QL0000J0100200](#) [QL0000J0220200](#) [QL0000J0470100](#) [QL0000J047J100](#) [QL0025J0101000](#) [QL0025J0102000](#)  
[QL0025J0470000](#) [QL0050J0100000](#) [QL0050J0362000](#) [QL0080J0470000](#) [R100W-10R](#) [R100W-22R](#) [R100W-470R](#) [R100W-4R7](#) [R150W-470R](#) [R200W-220R](#) [R200W-47R](#) [R50W-22R](#) [R50W-2R2](#) [R80W-10K](#) [R80W-47R](#) [SMW5R36JT](#) [SMW5R24JT](#) [SMW52R4JT](#) [SMW52R0JT](#)  
[SMW513RJT](#)