

TENMA®

Model 72-7740/72-7745

Operating Manual



© Copyright 2004 Tenma Test Equipment
All rights reserved

Tenma Test Equipment
405 S. Pioneer Blvd.
Springboro, Ohio 45066
www.tenma.com



Modern Digital Multimeter



Model 72-7740/72-7745: OPERATING MANUAL

Table of Contents

Title	Page
Overview	3
Unpacking Inspection	4
Safety Information	4
Rules For Safe Operation	5
International Electrical Symbols	6
The Meter Structure	7
Rotary Switch	8
Functional Buttons	9
Display Symbols	11
Measurement Ranges	
A. Selecting a Measurement Range	12
B. Manual Ranging and Autoranging	12
Measurement Operation	
A. DC Voltage Measurement	14
B. AC Voltage Measurement	15
C. Measuring Resistance	16
D. Testing for Continuity	17
E. Testing Diodes	18
F. Capacitance Measurement	19
G. Frequency Measurement	20
H. Measuring Duty Cycle	21
I. Temperature Measurement	22
J. DC or AC Current Measurement	22
Operation of Hold Mode	24
The Use of Relative Value Mode	24
The POWER Button	25
The BLUE Button	25
Turning on the Display Backlight	25
Sleep Mode (Model 72-7740 only)	25
General Specifications	26
Accuracy Specifications	
A. DC Voltage	27
B. AC Voltage	27
C. Resistance	27
D. Continuity Test	28



Model 72-7740/72-7745: OPERATING MANUAL

	Page
E. Diode Test	28
F. Capacitance	28
G. Frequency & Duty Cycle	28
H. Temperature	29
I. DC Current	29
J. AC Current	30
Maintenance	
A. General Service	31
B. Testing the Fuses	31
C. Replacing the Battery	32
D. Replacing the Fuses	33
RS232C Serial Port (Model 72-7745)	
A. RS232C Port Cable	35
B. Setting of RS232C Serial Ports	35
C. System Requirements for Installing the serial Interface Program	35



Model 72-7740/72-7745: OPERATING MANUAL

Overview

This Operating Manual covers information on safety and cautions. Please read the relevant information carefully and observe all the **Warnings** and **Notes** strictly.

Warning

To avoid electric shock or personal injury, read the “Safety Information” and “Rules for Safe Operation” carefully before using the Meter.

Digital Multimeter **Model 72-7740** and **Model 72-7745** (hereafter referred to as “the Meter”) have autorange and manual range options with maximum reading 3999. The enclosure structure design adopted advanced “co-injection” technique in order to provide sufficient insulation.

In addition to the conventional measuring functions, there is a RS232C standard serial port equipped with **Model 72-7745** for easy connection with computer to realize macro recording and monitoring and capture of transient dynamic data, displaying change of waveform during the measurement, providing data and evidence to engineering technicians for scientific research. This is also a highly applied digital multimeter of good performance with full overload protection and backlight function. **Model 72-7745** also has true rms reading for AC voltage and AC current measurements.



Model 72-7740/72-7745: OPERATING MANUAL

Unpacking Inspection

Open the package case and take out the Meter. Check the following items carefully to see any missing or damaged part:

Item	Description	Qty
1	Operating Manual	1 piece
2	Test Lead	1 pair
3	Test Clip	1 pair
4	Point Contact Temperature Probe	1 piece
5	9V Battery (NEDA1604, 6F22 or 006P) (installed)	1 piece
6	Model 72-7745:RS232C Interface Cable	1 piece
7	Model 72-7745:CD-ROM (Installation Guide & Computer Interface Software)	1 piece

In the event you find any missing or damage, please contact your dealer immediately.

Safety Information

This Meter complies with the standards IEC61010: in pollution degree 2, overvoltage category (CAT. III 1000V, CAT. IV 600V;)and double insulation.

CAT. III: Distribution level, fixed installation, with smaller transient overvoltages than CAT. IV

CAT IV: Primary supply level, overhead lines, cable systems etc.

Use the Meter only as specified in this operating manual, otherwise the protection provided by the Meter may be impaired.

In this manual, a **Warning** identifies conditions and actions that pose hazards to the user, or may damage the Meter or the equipment under test.

A **Note** identifies the information that user should pay attention to.

International electrical symbols used on the Meter and in this Operating Manual are explained on page 6.



Model 72-7740/72-7745: OPERATING MANUAL

Rules For Safe Operation

Warning

To avoid possible electric shock or personal injury, and to avoid possible damage to the Meter or to the equipment under test, adhere to the following rules:

- 1 Before using the Meter inspect the case. Do not use the Meter if it is damaged or the case (or part of the case) is removed. Look for cracks or missing plastic. Pay attention to the insulation around the connectors.
- 1 Inspect the test leads for damaged insulation or exposed metal. Check the test leads for continuity. Replace damaged test leads with identical model number or electrical specifications before using the Meter.
- 1 Do not apply more than the rated voltage, as marked on the Meter, between the terminals or between any terminal and ground.
- 1 The rotary switch should be placed in the correct position and no change of range made during measurement, to prevent damage of the Meter.
- 1 When working at an effective voltage over 60V DC or 30V rms AC, special care should be taken there is danger of electric shock.
- 1 Use the proper terminals, function, and range for your measurements.
- 1 Do not use or store the Meter in an environment of high temperature, humidity, explosive, flammable and strong magnetic field. The performance of the Meter may deteriorate after dampened.
- 1 When using the test leads, keep your fingers behind the finger guards.
- 1 Disconnect circuit power and discharge all high-voltage capacitors before testing resistance, continuity, diodes, current, or capacitance.
- 1 Before measuring current, check the Meter's fuses and turn off power to the circuit before connecting the Meter to the circuit.
- 1 Replace the battery as soon as the battery indicator "  " appears. With a low battery, the Meter might produce false readings that can lead to electric shock and personal injury.
- 1 Remove test lead, temperature probe, RS232C interface















Model 72-7740/72-7745: OPERATING MANUAL

cable and test clip from the Meter and turn the Meter power off before opening the case.

- 1 When servicing the Meter, use only the same model number or identical electrical specifications replacement parts.
- 1 The internal circuit of the Meter shall not be altered at will to avoid damage of the Meter and any accident.
- 1 Soft cloth and mild detergent should be used to clean the surface of the Meter when servicing. No abrasive and solvent should be used to prevent the surface of the Meter from corrosion, damage and accident.
- 1 The Meter is suitable for indoor use.
- 1 Under the environment with high (+/-4kV) electrostatic discharge, the Meter may not be operated as normal condition. The user may require resetting the Meter.
- 1 Remove the battery when not used for a prolonged period to avoid damage to the Meter.
- 1 Please constantly check the battery as it may leak when it has been using for some time, replace the battery as soon as leaking appears. A leaking battery will damage the Meter.
- 1 Periodically check the battery as it may leak after some time. If leakage is apparent, the battery should be immediately replaced to prevent damage.

International Electrical Symbols

	AC (Alternating Current)		Deficiency of Built-In Battery
	DC (Direct Current)		Continuity Test
	AC or DC		Diode
	Grounding		Capacitance Test
	Double Insulated		Fuse
	Warning. Refer to the Operating Manual		Conforms to Standards of European Union



Model 72-7740/72-7745: OPERATING MANUAL



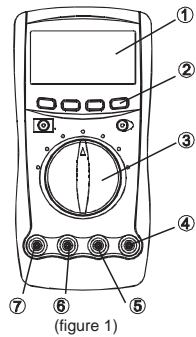





The Meter Structure(see figure 1)



- ① LCD Display
- ② Functional Buttons
- ③ Rotary Switch
- ④ **H_zV Ω** Input Terminal:
Input for voltage, frequency/duty cycle, resistance, diode, continuity and capacitance measurements.
- ⑤ **COM** Input Terminal:
Return terminal for all measurements.
- ⑥ **μ A mA^oC** Input Terminal:
Input for 0.1 μ A to 400.0mA current measurements and temperature testing.
- ⑦ **10A** Input Terminal:
Input for 0.01A to 10.00A current measurements.

Rotary Switch

The table below provides information about rotary switch positions.







Rotary Switch Position	Function
V 	DC voltage measurement range from 400.0mV to 1000V or AC voltage measurement range from 4.000V to 750.0V.
   	•) Continuity test.
	 Diode test.
	Ω Resistance measurement range from 400.0 Ω to 40.00M Ω .
	μ Capacitance test range from 40.00nF to 100.0 μ F.
$^{\circ}$ C	Temperature in celsius from -40° C ~ 1000 $^{\circ}$ C.
Hz	Frequency measurement range from 10.00Hz to 10.00MHz.
μ A 	AC or DC current measurement range from 400.0 μ A to 4000 μ A.
mA 	AC or DC current measurement range from 40.00mA to 400.0mA.
A 	AC or DC current measurement range from 4.000A to 10.00A.



Model 72-7740/72-7745: OPERATING MANUAL

Functional Buttons (1)

The table below provides information about functional button operation.

Button	Measuring Function	Operation Performed
POWER	Any rotary switch position	Turn the power on and off.
 (BLUE)	V 	Switches between AC and DC voltage; the Meter beeps. DC is default.
		Switches between continuity and diode and resistance and capacitance measurements; the Meter beeps. Resistance is default.
	μ A 	Switches between AC and DC current range from 400.0 μ A to 4000 μ A; the Meter beeps. DC is default.
	mA 	Switches between AC and DC current range from 40.00mA to 400.0mA; the Meter beeps. DC is default.
	A 	Switches between AC and DC current range from 4.000A to 10.00A; the Meter beeps. DC is default. Disable Sleep Mode feature.



Model 72-7740/72-7745: OPERATING MANUAL

Functional Buttons (2)

RANGE	Any rotary switch position except Hz and Hz %	<p>1 Press RANGE to enter the manual ranging mode; the Meter beeps.</p> <p>Manually selecting a range causes the Meter to exit the Hold and REL modes.</p> <p>1 Press RANGE to step through the ranges available for the selected function; the Meter beeps.</p> <p>1 Press and hold RANGE for 2 seconds to return to autoranging; the Meter beeps.</p>
Hz %	Hz	<p>1. Press to start the frequency counter; the Meter beeps.</p> <p>2. Press again to enter duty cycle mode; the Meter beeps.</p> <p>3. Press again to return to the frequency counter mode; the Meter beeps.</p>
	V \approx , μ A \approx , mA \approx or A \approx	<p>1. Press to start the frequency counter; the Meter beeps.</p> <p>2. Press again to enter duty cycle mode; the Meter beeps.</p> <p>3. Press again to return to the previous measurement mode; the Meter beeps.</p>
REL Δ	Any rotary switch position except Hz	Press REL Δ to enter and exit the REL mode in any measuring mode except in frequency/duty cycle; the Meter beeps.
HOLD \square	Any rotary switch position	Press HOLD \square to enter and exit the Hold mode in any mode, the Meter beeps.

Display Symbols (1) (see figure 2)

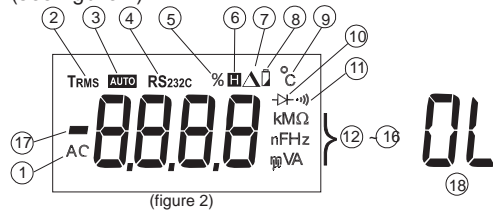

(figure 2)

Number	Symbol	Meaning
①	AC	Indicator for AC voltage or current. Model 72-7740: The displayed value is the mean value. Model 72-7745: The displayed value is the true rms value.
②	TRMS	Model 72-7745: Indicator for true rms value.
③	AUTO	The Meter is in the auto range mode in which the Meter automatically selects the range with the best resolution.
④	RS232C	Data output. It is always on the LCD, but data output is only in progress when the Meter is connected to the computer via the included RS232C Interface Cable.
⑤	%	Percent: Used for duty cycle measurements.
⑥	H	Data hold is active.
⑦	Δ	The REL is on to display the present value minus the stored value.
⑧	🔋	The battery is low. ⚠️Warning To avoid false readings, which could lead to possible electric shock or personal injury, replace the battery as soon as the battery indicator appears.
⑨	°C	Centigrade. The unit of temperature.
⑩	▶	Diode test.
⑪	•••	The continuity buzzer is on.



Model 72-7740/72-7745: OPERATING MANUAL

Display Symbols (1) (see figure 2)

⑫-⑯	Ω, kΩ, MΩ	Ω: Ohm. The unit of resistance. kΩ: kilohm. 1×10^3 or 1000 ohms. MΩ: Megaohm. 1×10^6 or 1,000,000 ohms
	F, μF, nF	F: Farad. The unit of capacitance. μF: Microfarad. 1×10^{-6} or 0.000001 farads. nF: Nanofarad. 1×10^{-9} or 0.000000001 farads.
	Hz, kHz, MHz	Hz: Hertz. The unit of frequency in cycles/second. kHz: Kilohertz. 1×10^3 or 1,000 hertz. MHz: Megahertz. 1×10^6 or 1,000,000 hertz.
	V, mV	V: Volts. The unit of voltage. mV: Millivolt. 1×10^{-3} or 0.001 volts.
	A, mA, μA	A: Amperes (amps). The unit of current. mA: Milliamp. 1×10^{-3} or 0.001 amperes. μA: Microamp. 1×10^{-6} or 0.000001 amperes.
⑰	—	Indicates negative reading.
⑱	OL	The input value is too large for the selected range.

Measurement Ranges (1)

A measurement range determines the highest value the Meter can measure. Most Meter functions have more than one range. See "Accuracy Specifications."

A. Selecting a Measurement Range

Choosing the correct measurement range is important:

- 1 If the range is too low for the input, the Meter displays **OL** to indicate an overload.
- 1 If the range is too high, the Meter will not display the most accurate measurement.

B. Manual Ranging and Autoranging

The Meter has both manual range and autorange options:



Model 72-7740/72-7745: OPERATING MANUAL

Measurement Ranges (2)

- 1 In the autorange mode, the Meter selects the best range for input signals.
This allows you to switch test points without having to reset the range.
- 1 In the manual range mode, you may select the range.
This allows you to override autorange and lock the Meter in a specific range.

The Meter defaults to the autorange mode in measurement functions that have more than one range. When the Meter is in the autorange mode, **AUTO** is displayed.

To enter and exit the manual range mode:

1. Press RANGE
The Meter enters the manual range mode and **AUTO** turns off. Pressing RANGE increments the range. When the highest range is reached, the Meter wraps to the lowest range.
2. To exit the manual range mode, press and hold RANGE for two seconds.
The Meter returns to the autorange mode and **AUTO** is displayed.

Note

- 1 If you manually change the measurement range after entering the REL or Hold recording modes, the Meter exits these modes.
- 1 Under frequency/duty cycle and capacitance measurement, only autorange mode is available.

Measurement Operation (1)

A. DC Voltage Measurement (see figure 3)

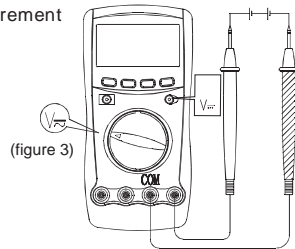

⚠ Warning

To avoid harm to you or damage to the Meter from electric shock, please do not attempt to measure voltages higher than 1000VDC / 750VAC rms although readings may be obtained.

The DC Voltage ranges are: 400.0mV, 4.000V, 40.00V, 400.0V and 1000V. To measure DC voltage, connect the Meter as follows:

1. Insert the red test lead into the $V\Omega$ terminal and the black test lead into the COM terminal.
2. Set the rotary switch to $V\text{---}$; DC measurement is default or press BLUE button to select DC measurement mode.
3. Connect the test leads across with the object being measured. The measured value shows on the display.

Note

- 1 In each range, the Meter has an input impedance of $10M\Omega$. This loading effect can cause measurement errors in high impedance circuits. If the circuit impedance is less than or equal to $10k\Omega$, the error is negligible (0.1% or less).
- 1 When DC voltage measurement has been completed, disconnect the connection between the test leads and the circuit under test, and move the test leads away from the input terminals of the Meter.

Measurement Operation (2)

B. AC Voltage Measurement (see figure 4)

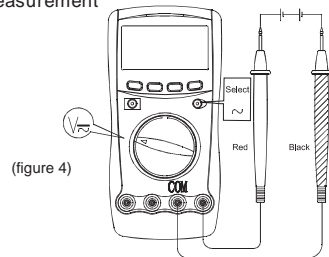

⚠ Warning

To avoid harm to you or damage to the Meter from electric shock, please do not attempt to measure voltages higher than 1000VDC / 750VAC rms although readings may be obtained.

The AC voltage ranges are: 4.000V, 40.00V, 400.0V and 750.0V. To measure AC Voltage, connect the Meter as follows:

1. Insert the red test lead into the HzVΩ terminal and the black test lead into the COM terminal.
2. Set the rotary switch to V \sim and press BLUE button to select AC measurement.
3. Connect the test leads across with the object being measured. The measured value shows on the display.

Note

- 1 In each range, the Meter has an input impedance of 10MΩ. This loading effect can cause measurement errors in high impedance circuits. If the circuit impedance is less than or equal to 10kΩ, the error is negligible (0.1% or less).
- 1 When AC voltage measurement has been completed, disconnect the connection between the testing leads and the circuit under test, and remove the testing leads away from the input terminals of the Meter.
- 1 True root mean square (TRMS) value stability period (Model 72-7745): When the reading obtained is less than 100 digits, the true root mean square value converter needs a longer time to stabilize. When there is no input voltage, the maximum reading displayed is 10 digits.

Measurement Operation (3)

C.Measuring Resistance (see figure 5)

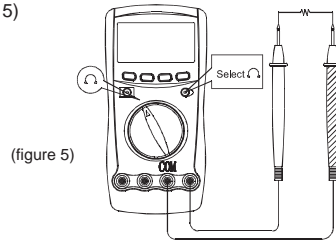

⚠Warning

To avoid damage to the Meter or to the devices under test, disconnect circuit power and discharge all the high-voltage capacitors before measuring resistance.

The resistance ranges are: 400.0Ω, 4.000k Ω, 40,00k Ω, 400.0kΩ, 4.000MΩ and 40.00MΩ. To measure resistance, connect the Meter as follows:

1. Insert the red test lead into the HzV Ω terminal and the black test lead into the COM terminal.
2. Set the rotary switch to Ω ; resistance measurement (Ω) is default or press BLUE button to select Ω measurement mode.
3. Connect the test leads across with the object being measured. The measured value shows on the display.

Note

- 1 The test leads can add 0.1Ω to 0.2 Ω of error to resistance measurement. To obtain precision readings in low-resistance measurement, that is the range of 400.0 Ω, short-circuit the input terminals beforehand, using the relative measurement function button REL Δ to automatically subtract the value measured when the testing leads are short-circuited from the reading.

Measurement Operation (4)

- 1 If Ω reading with shorted test leads is not $\leq 0.5\Omega$, check for loose test leads, incorrect function selection, or enabled Data Hold function.
- 1 For high-resistance measurement ($>1M\Omega$), it is normal to take several seconds to obtain a stable reading.
- 1 The LCD displays **OL** indicating open-circuit for the tested resistor or the resistor value is higher than the maximum range of the Meter.
- 1 When resistance measurement has been completed, disconnect the connection between the test leads and the circuit under test, and remove the test leads from the input terminals of the Meter.

D. Testing for Continuity (see figure 6)

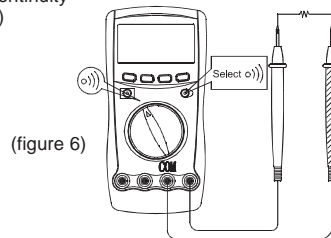

⚠ Warning

To avoid damage to the Meter or to the device under test, disconnect circuit power and discharge all the high-voltage capacitors before testing for continuity.

To test for continuity, connect the Meter as below:

1. Insert the red test lead into the HzV Ω terminal and the black test lead into the COM terminal.
2. Set the rotary switch to Ω with a diagonal line and vertical bar and press BLUE button to select Ω measurement mode.
3. The buzzer sounds if the resistance of a circuit under test is less than around 70 Ω .

Note

- 1 The LCD displays **OL** indicating the circuit being tested is open.

Measurement Operation (5)

- 1 When continuity testing has been completed, disconnect the connection between the test leads and the circuit under test, and remove the test leads from the input terminals of the Meter.

E. Testing Diodes (see figure 7)

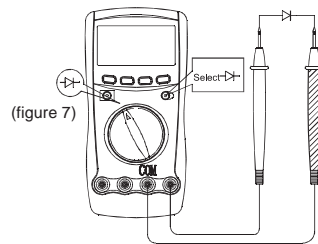



Warning

To avoid possible damage to the Meter and to the device under test, disconnect circuit power and discharge all high-voltage capacitors before testing diodes.

Use the diode test to check diodes, transistors, and other semiconductor devices. The diode test sends a current through the semiconductor junction, and then measures the voltage drop across the junction. A good silicon junction drops between 0.5V and 0.8V.

To test a diode out of a circuit, connect the Meter as follows:

1. Insert the red test lead into the HzVΩ terminal and the black testlead into the COM terminal.
2. Set the rotary switch to  and press BLUE button to select  measurement mode.
3. For forward voltage drop readings on any semiconductor component, place the red test lead on the component's anode and place the black test lead on the component's cathode. The measured value shows on the display.

Note

- 1 In a circuit, a good diode should still produce a forward



Model 72-7740/72-7745: OPERATING MANUAL

Measurement Operation (6)

voltage drop reading of 0.5V to 0.8V; however, the reverse voltage drop reading can vary depending on the resistance of other pathways between the probe tips.

- 1 Connect the test leads to the proper terminals as said above to avoid error display. The LCD will display **OL** indicating diode being tested is open or polarity is reversed. The unit of diode is Volt (V), displaying the forward voltage drop readings.
- 1 When diode testing has been completed, disconnect the connection between the testing leads and the circuit under test, and remove the testing leads away from the input terminals of the Meter.

F.Capacitance Measurement (see figure 8)

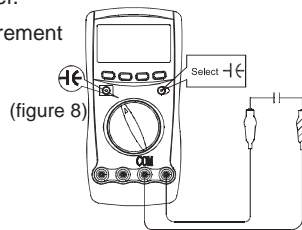

⚠Warning

To avoid damage to the Meter or to the equipment under test, disconnect circuit power and discharge all high-voltage capacitors before measuring capacitance. Use the DC Voltage function to confirm that the capacitor is discharged.

The Meter's capacitance ranges are: 40.00nF, 400.0nF, 4.000μF, 40.00μF, and 100.0μF. To measure capacitance, connect the Meter as follows:

1. Insert the red test lead into the HzVΩ terminal and the black test lead into the COM terminal.
2. Set the rotary switch to Ω with a capacitor symbol and press BLUE button to select nF measurement mode.
3. Connect the test leads across with the object being measured. The measured value shows on the display.

Note

- 1 For testing polarized capacitors, connect the red clip to

Measurement Operation (7)

anode & black clip to cathode instead of using test leads as mentioned above.

- 1 To minimize the effect of capacitance stored in the test leads, the test lead should be as short as possible. To measure a small value of capacitance, use REL mode to remove the leads capacitance. Remaining voltage, insulated impedance, & dielectric absorption from the capacitor may cause slight measurement error.
- 1 Higher value capacitors will require additional time for measurement. The 100 μ F range requires up to 15 seconds.
- 1 The LCD displays **OL** indicating the tested capacitor is shorted or it exceeds the maximum range.
- 1 When capacitance measurement has been completed, disconnect the connection between the test leads and the circuit under test and remove the test leads from the input terminals of the Meter.

G. Frequency Measurement (see figure 9)

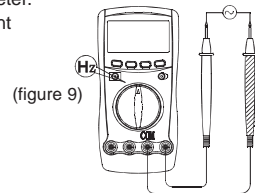

The measurement range is from 10Hz to 10MHz. To measure frequency, connect the Meter as follows:

1. Insert the red test lead into the HzV Ω terminal and the black test lead into the COM terminal.
2. Set the rotary switch to Hz; frequency measurement (Hz) is default or press Hz % to select Hz measurement mode.
3. Connect the test leads across with the object being measured. The measured value shows on the display.

Note

- 1 When frequency measurement has been completed, disconnect the connection between the test leads and the circuit under test, and remove the test leads from the input terminals of the Meter.



Model 72-7740/72-7745: OPERATING MANUAL

Measurement Operation (8)

- To obtain a stable reading when measuring input scope > 30V rms frequency signal:
Set the rotary switch to V_{\sim} .
Then press Hz% to select Hz measurement mode to obtain frequency value.
When input scope \leq 30V rms, please follow the above step 2. carrying out the measurement.
- When making frequency measurement at voltage or current range, please mind the following signal requirement table:

Range	Signal Requirement	Frequency Range
\sim 4V	$\geq 1.0V$	5Hz~10kHz
\sim 40V	≥ 5.0	5Hz~20kHz
\sim 400V	$\geq 45V$	45Hz~4kHz
\sim 1000V/~750V	≥ 420	45Hz~1.6kHz
\sim mA	$\geq 45mA$	5Hz~5kHz
\sim A	$\geq 4A$	45Hz~1kHz

H. Measuring Duty Cycle (See figure 9)

The duty cycle measurement range is: 0.1%~99.9%. To measure duty cycle, do the following:

- Set up the Meter to measure frequency.
- To select duty cycle, press Hz % until the % symbol is shown on the display.
- Connect the test leads across with the object being measured.
The measured value shows on the display.

Note

- The LCD displays 000.0% indicating the input signal is high or low level.
- When duty cycle measurement has been completed, disconnect the connection between the test leads and the circuit under test, and remove the test leads from the input terminals of the Meter.
- To obtain a stable reading when measuring input scope > 30V rms frequency signal:
Set the rotary switch to V_{\sim} .
Then press Hz% to select % measurement mode to obtain duty cycle value.
When input scope \leq 30V rms, please follow the above step 2. carrying out the measurement.

Measurement Operation (9)

I. Temperature Measurement(see figure 10)

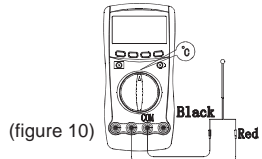

The temperature measurement range is $-40^{\circ}\text{C}\sim 1000^{\circ}\text{C}$. To measure temperature, connect the Meter as follows:

1. Insert the red temperature probe into the $\mu\text{A}/\text{mAC}$ terminal and the black temperature probe into the COM terminal.
2. Set the rotary switch to $^{\circ}\text{C}$.
3. Place the temperature probe to the object being measured. The measured value shows on the display.

Note

- 1 The Meter automatically displays the temperature value inside the Meter when there is no temperature probe connection.
- 1 The included point contact temperature probe can only be used up to 250°C . For any measurement higher than that, rod type temperature probe must be used.
- 1 When temperature measurement has been completed, disconnect the connection between the test leads and the circuit under test, and remove the test leads from the input terminals of the Meter.

J. DC or AC Current Measurement (see figure 11)

(figure 11)

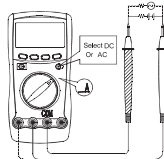

⚠ Warning

Never attempt an in-circuit current measurement where the open-circuit voltage between the circuit and ground is greater than 250V.

If the fuse burns out during measurement, the Meter may be damaged or the operator may be injured. Use proper terminals, function, and range for the measurement. When the test leads are connected to the current terminals, do not parallel them across any circuit.



Model 72-7740/72-7745: OPERATING MANUAL

Measurement Operation (10)

The current measurement has 3 measurement positions on the rotary switch: μA , mA and A.

The μA has a 400.0 μA and 4000 μA range, with auto ranging; the mA has a 40.00mA and 400.0mA range, with auto ranging; A position has a 4.000A and 10.00A range, with auto ranging.

To measure current, do the following:

1. Turn off power to the circuit. Discharge all high-voltage capacitors.
2. Insert the red test lead into the μA or 10A terminal and the black test lead into the COM terminal.
Use the 10A terminal and A range if the current value to be tested is an unknown.
3. Set the rotary switch to μA , mA, or A.
4. The Meter defaults to DC current measurement mode. To toggle between DC and AC current measurement function, press BLUE button.

Model 72-7740: AC current is displayed as effective value of sine wave (mean value response).

Model 72-7745: AC current is displayed as true rms value.

5. Break the current path to be tested. Connect the red test lead to the more positive side of the break and the black test lead to the more negative side of the break.
6. Turn on power to the circuit.
The measured value shows on the display.

Note

- 1 (TRMS) stability period: (Model 72-7745)

When the reading obtained is less than 100 digits, the true root mean square value converter needs a longer time to stabilize. When there is no input voltage, the maximum reading displayed is 10 digits.

- 1 For safety sake, each measurement time for high current should be less than 10 seconds and the interval time between 2 measurements should be greater than 15 minutes.
- 1 When current measurement has been completed, disconnect the connection between the test leads and the circuit under test, and remove the test leads from the input terminals of the Meter.



Model 72-7740/72-7745: OPERATING MANUAL

Operation of Hold Mode

Warning

To avoid possibility of electric shock, do not use Hold mode to determine if circuits are without power. The Hold mode will not capture unstable or noisy readings.

The Hold mode is applicable to all measurement functions.

- 1 Press **HOLD** to enter Hold mode; the Meter beeps.
- 1 Press **HOLD** again or RANGE or Hz % or turn the rotary switch to exit Hold mode; the Meter beeps.
- 1 In Hold mode is displayed.

The Use of Relative Value Mode

The REL mode applies to all measurement functions except frequency/duty cycle measurement. It subtracts a stored value from the present measurement value and displays the result.

For instance, if the stored value is 20.0V and the present measurement value is 22.0V, the reading would be 2.0V. If a new measurement value is equal to the stored value then display 0.0V.

To enter or exit REL mode:

- 1 Use rotary switch to select the measurement function before selecting REL . If measurement function changes manually after REL is selected, the Meter exits the REL mode.
- 1 Press REL to enter REL mode, auto ranging turns off except under capacitance testing mode, and the present measurement range is locked and display "0" as the stored value.
- 1 Press REL again or turn the rotary switch to reset the stored value and exit REL mode.

Pressing HOLD in REL mode makes the Meter stop updating. Pressing HOLD again to resume updating.



Model 72-7740/72-7745: OPERATING MANUAL

The POWER button

This is a self-lock switch used to turn on or off the power of the Meter.



The BLUE button

It is used for selecting the required measurement function when more than one function exists at one position of the rotary switch.

Turning on the Display Backlight

Warning

In order to avoid the hazard arising from mistaken readings in insufficient light or poor vision, please use Display Backlight function.

- 1 Press and hold HOLD  for over 2 seconds to turn the Display Backlight on.
- 1 Press and hold HOLD  again for over 2 seconds to turn the Display Backlight off, otherwise it will stay on continuously.

Sleep Mode (Model 72-7740)





To preserve battery life, the Meter automatically turns off after 30 minutes of inactivity.

To disable the Sleep Mode function, press BLUE button while turning on the Meter.



Model 72-7740/72-7745: OPERATING MANUAL

General Specifications

- 1 Maximum Voltage between any Terminals and Grounding: 1000V.
- 1  Fused Protection for μ mA Input Terminal:
Glass fuse, 0.5A, 250V, fast type, 5x20mm.
- 1  Fused Protection for 10A Input Terminal:
Glass fuse, 10A, 250V, fast type, 5x20mm.
- 1 Maximum Display: Digital: 3999
- 1 Measurement Speed: Updates 3 times/second.
- 1 Temperature: Operating : 0°C~40°C (32°F ~104 °F).
Storage : -10°C~50°C (14°F~122°F).
- 1 Relative Humidity: $\leq 75\%$ @ 0°C - 30°C; $\leq 50\%$ @ 31°C - 40°C;
- 1 Altitude: Operating: 2000 m.
Storage : 10000 m.
- 1 Battery Type: One piece of 9V (NEDA1604 or 6F22 or 006P).
- 1 Low Battery : Display 
- 1 Dimensions (HxWxL): 177 x 85 x 40 mm.
- 1 Weight: Approximate 300g (battery included).
- 1 Safety/Compliances: IEC61010 CAT.III 1000V,
CAT.IV 600V overvoltage and double insulation standard.
- 1 Certifications:  ,UL & CUL



Model 72-7740/72-7745: OPERATING MANUAL

Accuracy Specifications (1)

Accuracy: $\pm (a\% \text{ reading} + b \text{ digits})$, guarantee for 1 year.

Operating temperature: $23^{\circ}\text{C} \pm 5^{\circ}\text{C}$.

Relative humidity: $< 75\%$.

Temperature coefficient: $0.1 \times (\text{specified accuracy})/1^{\circ}\text{C}$

A. DC Voltage

Range	Resolution	Accuracy	Overload Protection
400mV	0.1mV	$\pm (0.8\%+3)$	1000V DC 750V AC rms continuous.
4V	1mV	$\pm (0.8\%+1)$	
40V	10mV		
400V	100mV		
1000V	1V	$\pm (1\%+3)$	

Remarks: Input impedance $\geq 10\text{M}\Omega$.

B. AC Voltage

Range	Resolution	Accuracy	Overload Protection
4V	1mV	$\pm (1\%+5)$	1000V DC 750V AC rms continuous.
40V	10mV		
400V	100mV		
750V	1V	$\pm (1.2\%+5)$	

Remarks:

1 Input impedance $\geq 10\text{M}\Omega$.

1 Model 72-7740: displays effective value of sine wave (mean value response).

Model 72-7745: displays true rms value.

1 Frequency response 40Hz~400Hz.

C. Resistance

Range	Resolution	Accuracy	Overload Protection
400 Ω	0.1 Ω	Measure at REL mode $\pm (1.2\%+2)$	1000Vp
4k Ω	1 Ω	$\pm (1\%+2)$	
40k Ω	10 Ω		
400k Ω	100 Ω		
4M Ω	1k Ω	$\pm (1.2\%+2)$	
40M Ω	10k Ω	$\pm (1.5\%+2)$	

Remarks Open circuit voltage approximate 0.45V.



Model 72-7740/72-7745: OPERATING MANUAL

Accuracy Specifications (2)

D Continuity Test

Range	Resolution	Accuracy	Overload Protection
400.0Ω	0.1Ω	Approximate $\leq 100\Omega$	1000Vp

Remarks:

- 1 Buzzer beeps continuously.
- 1 Open circuit voltage approximate 0.45V.

E. Diode Test

Range	Resolution	Overload Protection
Diode	1mV	1000Vp

Remarks:

- 1 Open circuit voltage approximate 1.48V.
- 1 Displays approximate forward voltage drop reading 0.5V~0.8V.

F. Capacitance

Range	Resolution	Accuracy	Overload Protection
40nF	10pF	Measure at REL mode $\pm(3\%+10)$	1000Vp
400nF	100pF	$\pm(3\%+5)$	
4μF	1nF		
40μF	10nF		
100μF	100nF	$\pm(4\%+5)$	

G. Frequency & Duty Cycle

Range	Resolution	Accuracy	Overload Protection
10Hz~10MHz		$\pm(0.1\%+3)$	1000Vp
0.1%~99.9%	0.01%		

Remarks:

- 1 10Hz~10MHz Range:
 - $\leq 1\text{MHz}$: 300mV rms \leq input sensitivity $\leq 30\text{V rms}$;
 - $> 1\text{MHz}$: 600mV rms \leq input sensitivity $\leq 30\text{V rms}$.
- 1 0.1%~99.9%:
Reading is only for reference purpose.



Model 72-7740/72-7745: OPERATING MANUAL

Accuracy Specifications (3)

H. Temperature

Range	Resolution	Accuracy	
-40°C~ 1000°C	1°C	-40°C ~0°C	±(3%+4)
		0°C ~400°C	±(1%+3)
		400°C ~1000°C	±(2%+10)

Overload Protection:

Glass fuse 0.5A, 250V, fast type, ϕ 5x20mm.

I. DC Current

Range	Resolution	Accuracy	Overload Protection
400 μ A	0.1 μ A	±(1%+2)	Glass fuse 0.5A, 250V, fast type Glass fuse, ϕ 5x20 mm.
4000 μ A	1 μ A		
40mA	0.01mA		
400mA	0.1mA		
4A	0.001A	±(1.5%+5)	Glass fuse 10A, 250V, fast type Glass fuse, ϕ 5x20 mm.
10A	0.01A		

Remarks:

1 4A & 10A Range:

For continuous measurement \leq 10 seconds and interval not less than 15 minutes.



Model 72-7740/72-7745: OPERATING MANUAL

Accuracy Specifications (4)

J. AC Current

Range	Resolution	Accuracy	Overload Protection
400 μ A	0.1 μ A	$\pm(1.5\%+5)$	0.5A, 250V, fast type Glass fuse, ϕ 5x20 mm.
4000 μ A	1 μ A		
40mA	0.01mA		
400mA	0.1mA	$\pm(2\%+5)$	
4A	0.001A	$\pm(2.5\%+5)$	10A, 250V, fast type Glass fuse, ϕ 5x20 mm.
10A	0.01A		

Remarks:

Frequency response 40Hz ~ 400Hz.

Model 72-7740 : displays effective value of sine wave
(mean value response).

Model 72-7745 : displays true rms value.

1 4A & 10A Range:

For continuous measurement \leq 10 seconds
and interval not less than 15 minutes.



Model 72-7740/72-7745: OPERATING MANUAL

MAINTENANCE

This section provides basic maintenance information including battery and fuse replacement instruction.

Warning

Do not attempt to repair or service your Meter unless you are qualified to do so and have the relevant calibration, performance test, and service information.

To avoid electrical shock or damage to the Meter, do not get water inside the case.

A. General Service

- 1 Periodically wipe the case with a damp cloth and mild detergent. Do not use abrasives or solvents.
- 1 To clean the terminals with cotton bar with detergent, as dirt or moisture in the terminals can affect readings.
- 1 Turn off the power of the Meter when it is not in use and take out the battery when not using for a long time.
- 1 Take out the battery when it is using for a long time.
- 1 Do not use or store the Meter in a place of humidity, high temperature, explosive, inflammable and strong magnetic field.



B. Testing the Fuses

Warning

To avoid electrical shock or personal injury, remove the test leads and any input signals before replacing the battery or fuse.

To prevent damage or injury, install ONLY replacement fuses with identical amperage, voltage, and speed ratings.

To test the fuse:

1. Set the rotary switch to  and press BLUE button to select .
2. Plug a test lead into the terminal HzV  and touch the probe to the 10A terminal.

- 1 If the Meter beeps, the fuse is good.
- 1 If the display shows **OL**, replace the fuse and test again.
- 1 If the display shows any other value, have the Meter serviced and contact your dealer immediately.

If the Meter does not work while the fuse is all right, send it to your dealer for repair.

C. Replacing the Battery (see figure 12)

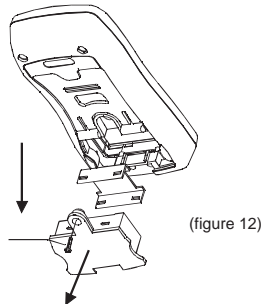

⚠ Warning

To avoid false readings, which could lead to possible electric shock or personal injury, replace the battery as soon as the battery indicator "⚡" appears.

Make sure the test leads are disconnected from the circuit being tested before opening the case bottom.

To replace the battery:

1. Press the POWER to turn the Meter off and remove all connections from the terminals.
2. Remove the screw from the battery compartment, and separate the battery compartment from the case bottom.
3. Remove the battery from the battery compartment.
4. Replace the battery with a new 9V battery (NEDA1604, 6F22 or 006P)
5. Rejoin the case bottom and battery compartment, and reinstall the screw.



Model 72-7740/72-7745: OPERATING MANUAL

D. Replacing the Fuses (see figure 13)

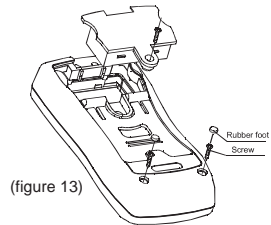

⚠ Warning

To avoid electrical shock, arc blast, personal injury or damage to the Meter, use specified fuses **ONLY** in accordance with the following procedure.

To replace the Meter's fuse:

1. Press the **POWER** to turn the Meter off and remove all connections from the terminals.
2. Remove the screw from the battery compartment, and separate the battery compartment from the case bottom.
3. Remove the 2 rubber feet and 2 screws from the case bottom, and separate the case top from the case bottom.
4. Remove the fuse by gently prying one end loose, then take out the fuse from its bracket.
5. Install **ONLY** replacement fuses with the identical type and specification as follows and make sure the fuse is fixed firmly in the bracket.
Fuse 1: Glass fuse 0.5A, 250V, fast type, ϕ 5x20mm.
Fuse 2: Glass fuse 10A, 250V, fast type, ϕ 5x20mm.



Model 72-7740/72-7745: OPERATING MANUAL

6. Rejoin the battery compartment and the case top, and reinstall the screw.
7. Rejoin the case bottom and case top, and reinstall the 2 screws and 2 rubber feet.

Replacement of the fuses is seldom required. Burning of a fuse always results from improper operation.



Model 72-7740/72-7745: OPERATING MANUAL

RS232C Serial Port (Model 72-7745)

A. RS232C Port Cable

The Meter	Computer		
	D-sub 9 Pin Female	D-sub 25 Pin Female	Pin Name
2	2	3	RX
3	3	2	TX
4	4	20	DTR
5	5	7	GND
6	6	6	DSR
7	7	4	RTS
8	8	5	CTS

B. Setting of RS232C Serial Ports

Default of RS232C serial port for communication is set as:

Baud Rate 2400
Start bit 1 (always 0)
Stop bit 1 (always 1)
Data bits 7
Parity Odd

C. System Requirements for Installing the serial Interface Program

To use **serial Interface Program**, you need the following hardware and software:

- An IBM PC or equivalent computer with 80486 or higher processor and 640 x 480 pixel or better monitor.
- Microsoft Windows 95 or above.
- At least 8MB of RAM.
- At least 8MB free space in hard drive.
- Can access to a local or a network CD-ROM.
- A free serial port.
- A mouse or other pointing device supported by Windows.

Please refer to the included CD-ROM **Installation Guide & Computer Interface Software** for installing and operating instructions of the **serial Interface Program**.

~ END ~



Model 72-7740/72-7745: OPERATING MANUAL

Tenma Test Equipment
405 S. Pioneer Blvd.
Springboro, Ohio 45066
www.tenma.com

X-ON Electronics

Largest Supplier of Electrical and Electronic Components

Click to view similar products for [tenma manufacturer](#):

Other Similar products are found below :

[21-10164](#) [21-10158](#) [72-7715](#) [BC0024434](#) [72-7712](#) [76-009](#) [76-081](#) [CBB019217](#) [CBB018722](#) [72-9170](#) [72-13668](#) [72-13686](#) [72-13688](#) [72-13736](#) [72-13742](#) [72-13818](#) [72-13822](#) [72-13824](#) [72-13836](#) [72-13856](#) [72-13858](#) [72-13872](#) [72-13874](#) [72-13908](#) [72-13950](#) [72-13986](#) [72-14060](#) [72-14302](#) [72-3099](#) [76-1448](#) [76-1556](#) [76-019](#) [76-024](#) [76-1568](#) [21-670](#) [72-14400](#) [72-13762](#) [72-13826](#) [72-13832](#) [72-13888](#) [72-13942](#) [72-14008](#) [72-14014](#) [72-14048](#) [72-14148](#) [72-14230](#) [72-17175](#) [72-2655](#) [72-7615](#) [76-097](#)