

SFP HSMC

Terasic SFP HSMC Board

User Manual



INTRODUCTION.....	1
1.1 1.1 FEATURES.....	1
1.2 1.2 ABOUT THE KIT	2
1.3 1.3 ASSEMBLE THE SFP HSMC BOARD	3
1.4 1.4 GETTING HELP	5
ARCHITECTURE.....	6
2.1 2.1 LAYOUT AND COMPONENTS.....	6
2.2 2.2 BLOCK DIAGRAM	8
BOARD COMPONENTS.....	9
3.1 3.1 THE SFP HSMC CONNECTOR.....	9
3.2 3.2 CLOCK CIRCUITRY.....	15
3.3 3.3 POWER SUPPLY.....	17
DEMONSTRATION	18
4.1 4.1 INTRODUCTION	18
4.2 4.2 SYSTEM REQUIREMENTS	18
4.3 4.3 SETUP THE DEMONSTRATION	18
4.4 4.4 DEMO OPERATION.....	20
4.5 4.5 OVERVIEW	21
APPENDIX.....	23
5.1 5.1 REVISION HISTORY.....	23
5.2 5.2 ALWAYS VISIT SFP HSMC WEBPAGE FOR NEW MAIN BOARD.....	23

1 Introduction

The Small Form-Factor Pluggable (SFP) HSMC board is a hardware platform for evaluating the interoperation of Altera FPGA, specifically Stratix IV GX, Arria GX, and Arria II GX, with generic SFP modules. The optical modules that are of particular importance are SGMII Ethernet, Fiber channel, CPRI/OBSAI and SONET. Furthermore, the SFP HSMC board is intended for customers to implement both telecommunication and data communications applications.

1.1 Features

Figure 1.1 shows the photo of the SFP HSMC board. The important features are listed below:

- 8 SFP Connectors
 - ✓ 4 Transceiver Based SFPs
 - ✓ 4 LVDS Bases SFPs
- 8 SMAs
 - ✓ 2 Transceiver Receive SMAs
 - ✓ 2 Transceiver Transmit SMAs
 - ✓ 1 LVDS Clock Input SMA pair (2 SMAs)
 - ✓ 2 Single-ended Clock Outputs SMAs
 - ✓ 1 LVDS Clock Output SMA pair (2 SMAs)
 - ✓ 1 LVPECL Clock Output SMA pair (2 SMAs)
- Power
 - ✓ 12V to 4V
 - ✓ 4V to 3.3V
- Clocks
 - ✓ 61.44 MHz
 - ✓ 125 MHz
 - ✓ 155.52 MHz
 - ✓ 156.25 MHz
 - ✓ Differential SMA
- High Speed Mezzanine Card (HSMC)



Figure 1.1. The SFP HSMC Board

1.2 About the KIT

This section describes the package content

- SFP HSMC Board x 1
- System CD-ROM x 1

The CD contains technical documents of the SFP HSMC, and reference designs along with the source code.

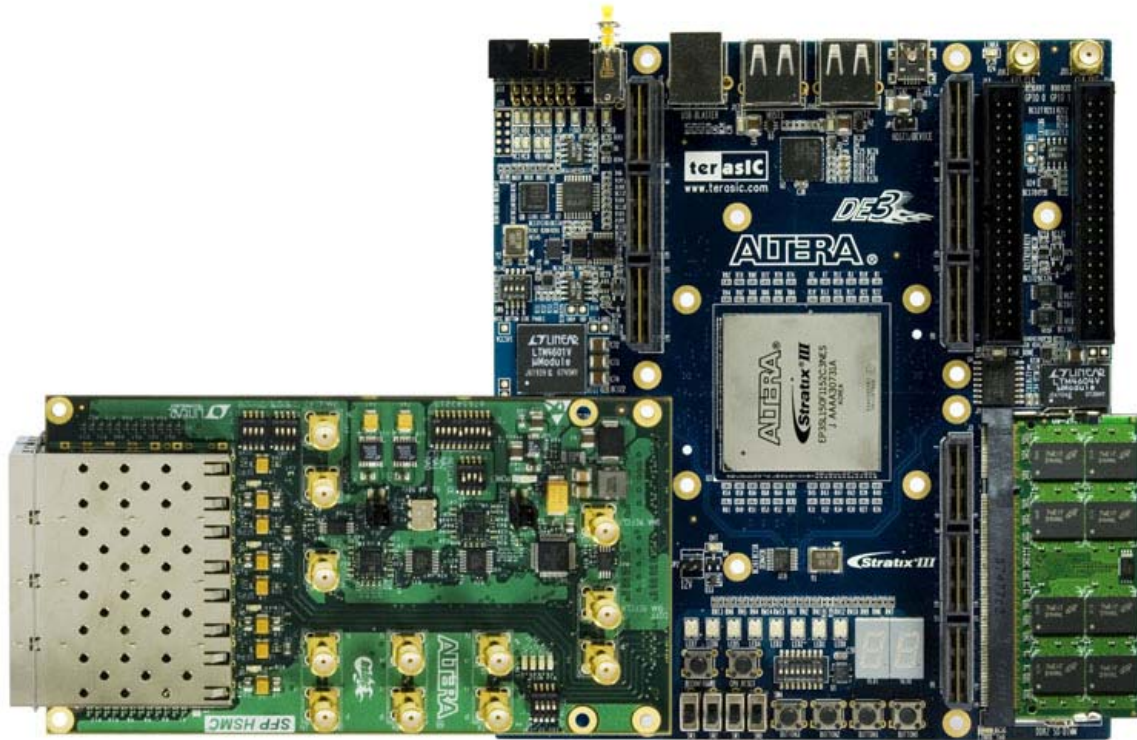

Figure 1.2 SFP HSMC Package

1.3 Assemble the SFP HSMC Board

This section describes how to connect the SFP HSMC board to a main board.

The SFP HSMC board connects with Altera DE3 Board



The SFP HSMC connects to the Stratix IV GX FPGA Development Board

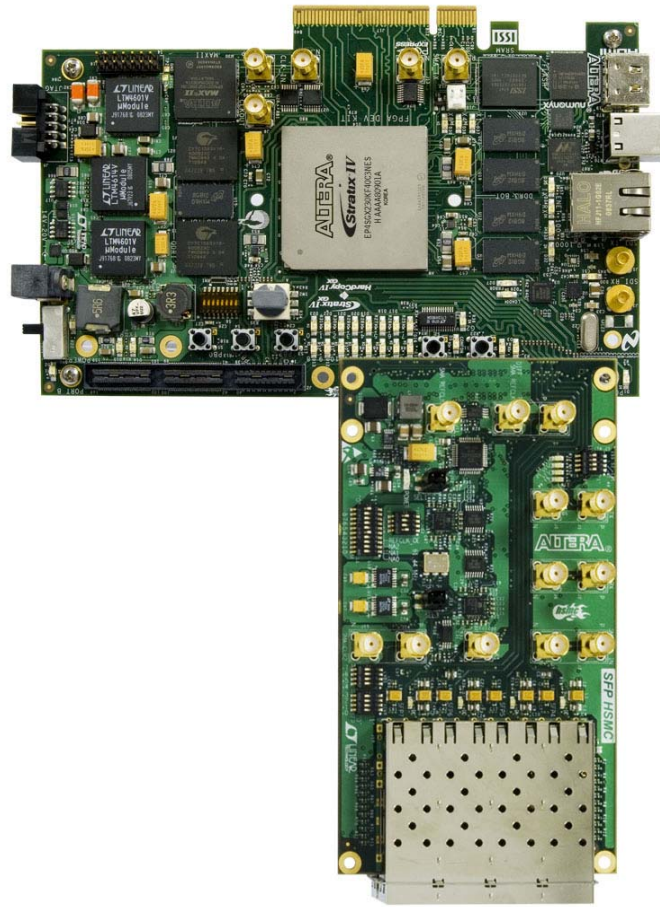

The SFP HSMC board connects with Altera Stratix III FPGA Development Kit

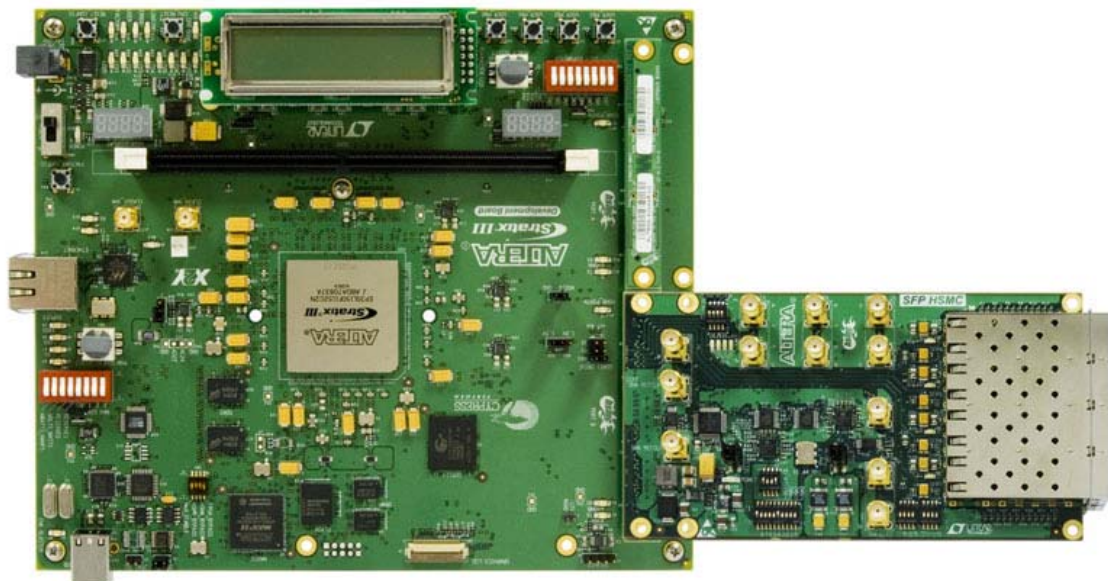

Note. Do not attempt to connect/remove the SFP HSMC daughter board to/from the main board when the power is on, or else the hardware could be damaged.

1.4 Getting Help

Here are some places to get help if you encounter any problem:

- ✓ Email to support@terasic.com
- ✓ Taiwan & China: +886-3-550-8800
- ✓ Korea : +82-2-512-7661
- ✓ Japan: +81-428-77-7000

This Chapter covers the architecture of the SFP HSMC board including its PCB and block diagram.

2.1 Layout and Components

The picture of the SFP HSMC board is shown in Figure 2.1 and Figure 2.2. It depicts the layout of the board and indicates the location of the connectors and key components.

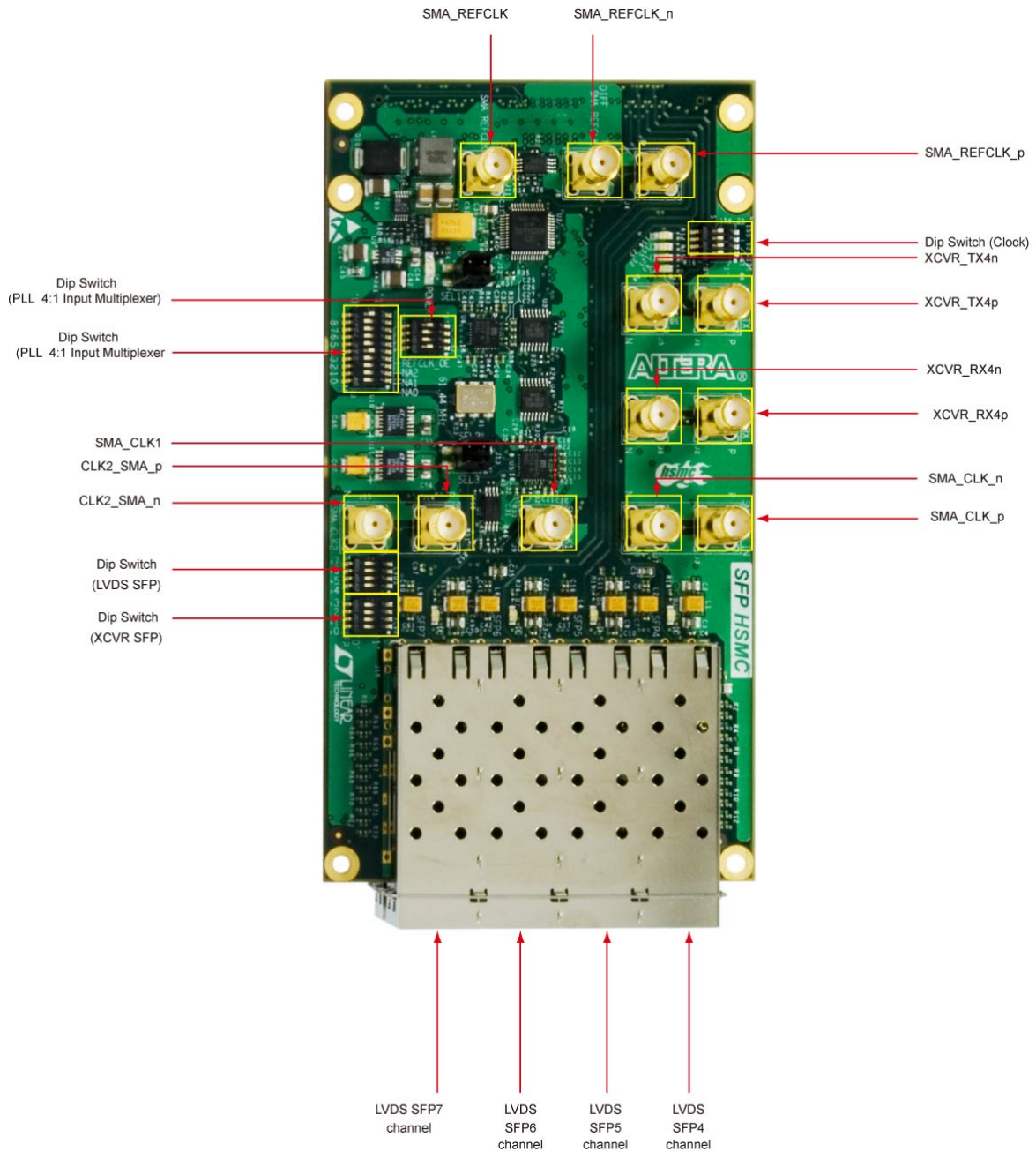

Figure 2.1. The SFP HSMC PCB and component diagram

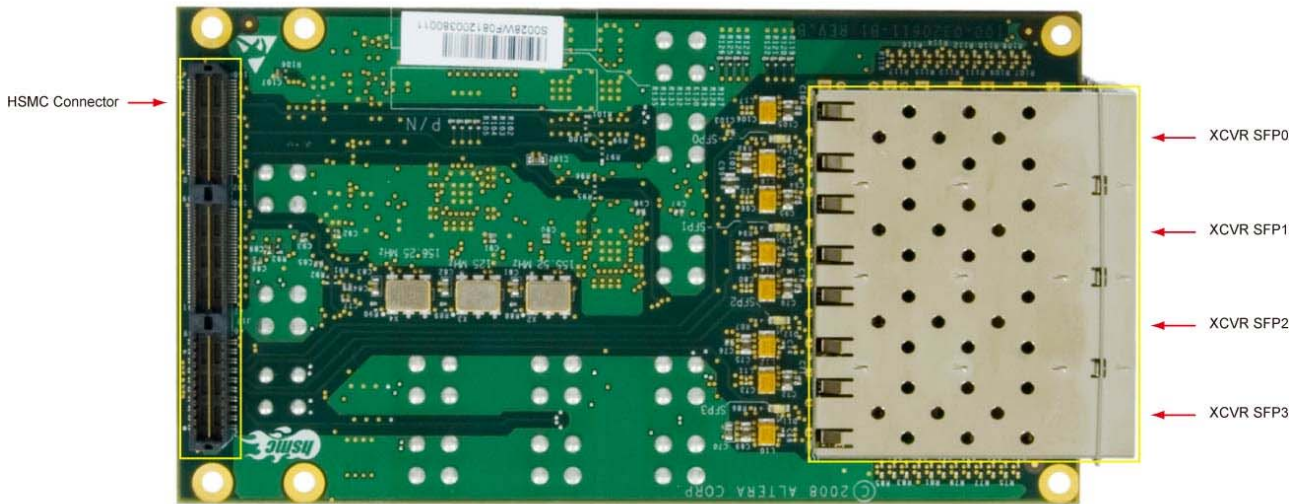

Figure 2.2. The SFP HSMC Back side – HSMC connector view

The following components are provided on the SFP HSMC board :

- LVDS SFP[4-7] (J10), XCVR SFP Dip Switch (S5), XCVR LVDS Dip Switch (S4), CLK2_SMA_p (J14), CLK2_SMA_n (J15), SMA_CLK1 (J9), PLL 4:1 Input Multiplexer Dip Switch (S3), PLL 4:1 Input Multiplexer Dip Switch (S2), SMA_REFCLK (J11), SMA_REFCLK_n (J8), SMA_REFCLK_p (J4), CLOCK Dip Switch (S1), XCVR_TX4n (J5), XCVR_TX4p (J1), XCVR_TX4n (J6), XCVR_RX4p (J2), SMA_CLK_n (J7), SMA_CLK_p (J3)
- HSMC Connector (J17), XCVR SFP[0-3] (J16)

2.2 Block Diagram

Figure 2.3 shows the block diagram of the SFP HSMC board

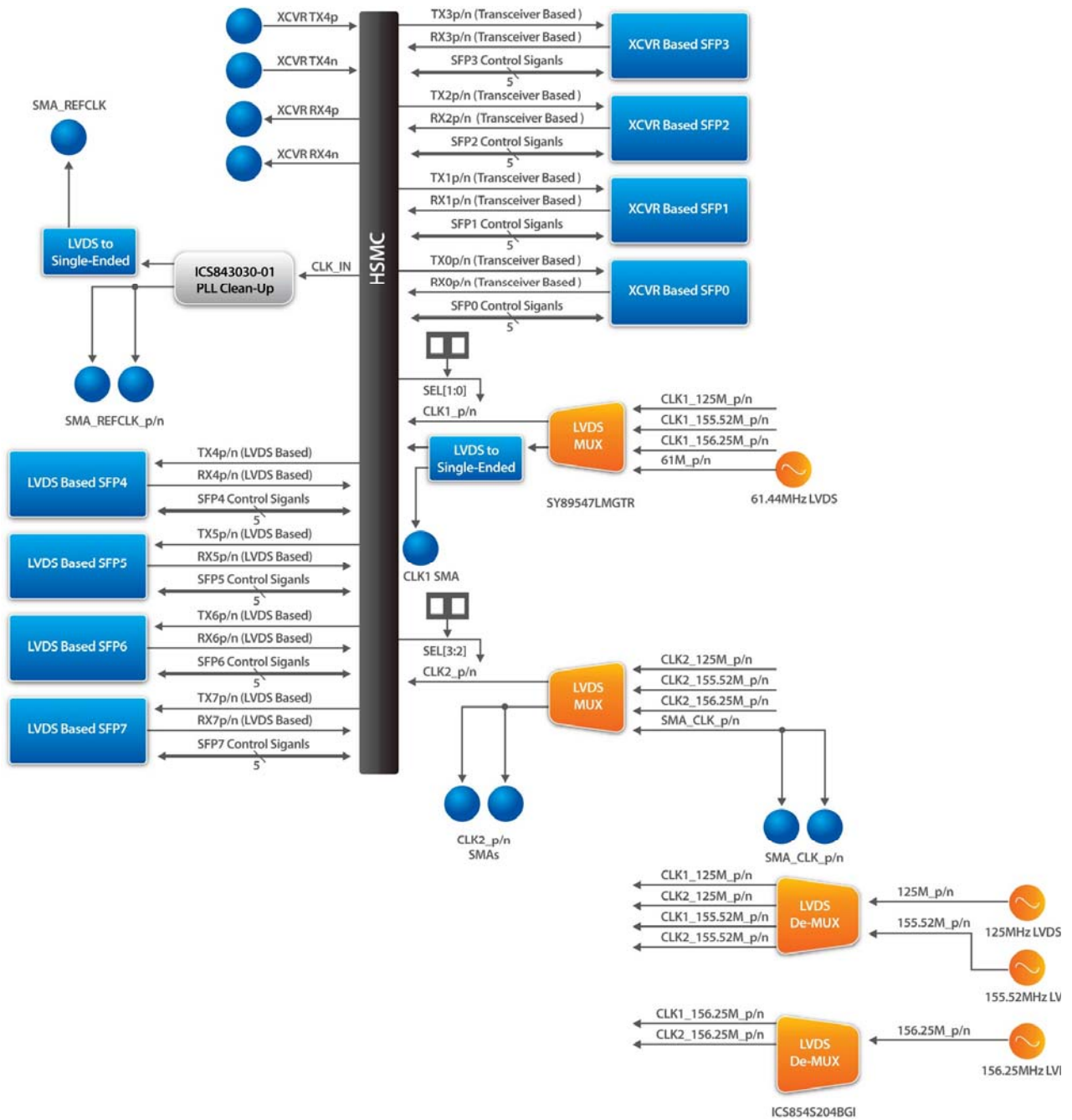

Figure 2.3. The block diagram of the SFP HSMC board

This section illustrates the detailed information of the components, connector interfaces, and the pin mapping tables of the SFP HSMC board.

3.1 The SFP HSMC Connector

This section describes pin definition of the SFP HSMC interface onboard

All the control and data signals of the SFPs are connected to the HSMC connector, so users can fully control the SFP HSMC daughter board through the HSMC interface. Power is derived from 3.3V and 12V of the HSMC connector.

Board Components

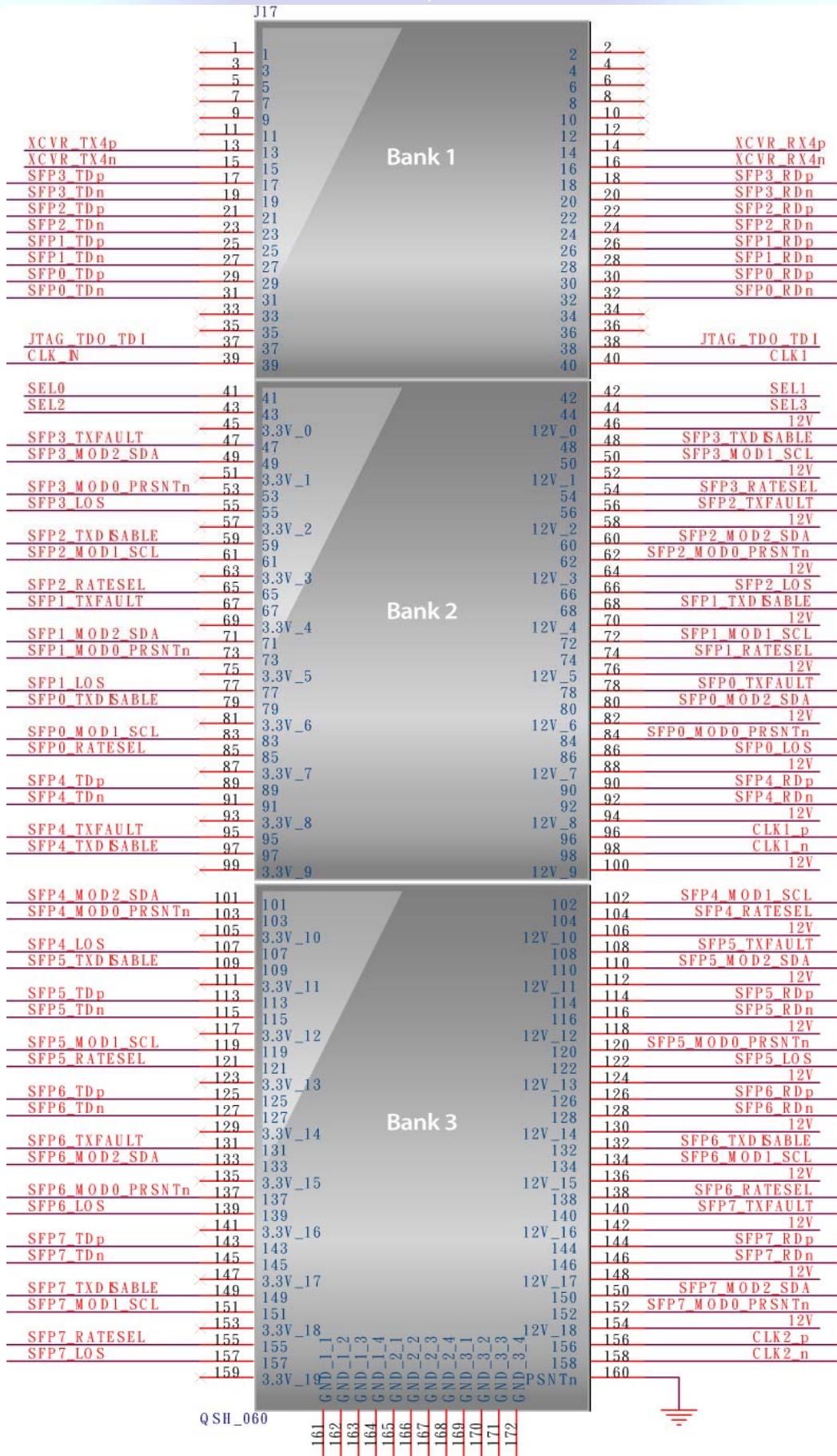

Figure 3.1. The pin-outs on the HSMC connector

The table 3.1 below lists the HSMC signal direction and description.

Pin Numbers	Name	Direction	Description
1	N.C.	N/A	Not Connect
2	N.C.	N/A	Not Connect
3	N.C.	N/A	Not Connect
4	N.C.	N/A	Not Connect
5	N.C.	N/A	Not Connect
6	N.C.	N/A	Not Connect
7	N.C.	N/A	Not Connect
8	N.C.	N/A	Not Connect
9	N.C.	N/A	Not Connect
10	N.C.	N/A	Not Connect
11	N.C.	N/A	Not Connect
12	N.C.	N/A	Not Connect
13	XCVR_TX4p	Output	SMA Transceiver Input
14	XCVR_RX4p	Input	SMA Transceiver Output
15	XCVR_TX4n	Output	SMA Transceiver Input
16	XCVR_RX4n	Input	SMA Transceiver Output
17	SFP3_TDp	Output	Transmitter Non-Inverted Data Input
18	SFP3_RDp	Input	Receiver Non-Inverted Data Output
19	SFP3_TDn	Output	Transmitter Inverted Data Input
20	SFP3_RDn	Input	Receiver Inverted Data Output
21	SFP2_TDp	Output	Transmitter Non-Inverted Data Input
22	SFP2_RDp	Input	Receiver Non-Inverted Data Output
23	SFP2_TDn	Output	Transmitter Inverted Data Input
24	SFP2_RDn	Input	Receiver Inverted Data Output
25	SFP1_TDp	Output	Transmitter Non-Inverted Data Input
26	SFP1_RDp	Input	Receiver Non-Inverted Data Output
27	SFP1_TDn	Output	Transmitter Inverted Data Input
28	SFP1_RDn	Input	Receiver Inverted Data Output
29	SFP0_TDp	Output	Transmitter Non-Inverted Data Input
30	SFP0_RDp	Input	Receiver Non-Inverted Data Output
31	SFP0_TDn	Output	Transmitter Inverted Data Input
32	SFP0_RDn	Input	Receiver Inverted Data Output
33	N.C.	N/A	Not Connect
34	N.C.	N/A	Not Connect
35	N.C.	N/A	Not Connect

Board Components

36	N.C.	N/A	Not Connect
37	JTAG_TDO_TDI	Inout	JTAG data loop through
38	JTAG_TDO_TDI	Inout	JTAG data loop through
39	N.C.	N/A	Not Connect
40	N.C.	N/A	Not Connect
41	SEL[0]	Inout	CLK 1 Select bit 0
42	SEL[1]	Inout	CLK 1 Select bit 1
43	SEL[2]	Inout	CLK 2 Select bit 2
44	SEL[3]	Inout	CLK 2 Select bit 3
45	3V3	Power	Power 3.3V
46	12V	Power	Power 12V
47	SFP3_TXFAULT	Input	Module Transmitter Fault
48	SFP3_TXDISABLE	Output	Transmitter Disable, Turns off transmitter laser output
49	SFP3_MOD2_SDA	Input	SDA Serial Data Signal
50	SFP3_MOD1_SCL	Inout	SCL Serial Clock Signal
51	3V3	Power	Power 3.3V
52	12V	Power	Power 12V
53	SFP3_MOD0_PRSENTn	Input	LED indicator that the module is present
54	SFP3_RATESEL	Output	Rate Select
55	SFP3_LOS	Input	Receiver Loss of Signal Indication
56	SFP2_TXFAULT	Input	Module Transmitter Fault
57	3V3	Power	Power 3.3V
58	12V	Power	Power 12V
59	SFP2_TXDISABLE	Output	Transmitter Disable, Turns off transmitter laser output
60	SFP2_MOD2_SDA	Inout	SDA Serial Data Signal
61	SFP2_MOD1_SCL	Output	SCL Serial Clock Signal
62	SFP2_MOD0_PRSENTn	Input	LED indicator that the module is present
63	3V3	Power	Power 3.3V
64	12V	Power	Power 12V
65	SFP2_RATESEL	Output	Rate Select
66	SFP2_LOS	Input	Receiver Loss of Signal Indication
67	SFP1_TXFAULT	Input	Module Transmitter Fault
68	SFP1_TXDISABLE	Output	Transmitter Disable, Turns off transmitter laser output
69	3V3	Power	Power 3.3V
70	12V	Power	Power 12V
71	SFP1_MOD2_SDA	Inout	SDA Serial Data Signal
72	SFP1_MOD1_SCL	Output	SCL Serial Clock Signal
73	SFP1_MOD0_PRSENTn	Input	LED indicator that the module is present

Board Components

74	SFP1_RATESEL	Output	Rate Select
75	3V3	Power	Power 3.3V
76	12V	Power	Power 12V
77	SFP1_LOS	Input	Receiver Loss of Signal Indication
78	SFP0_TXFAULT	Input	Module Transmitter Fault
79	SFP0_TXDISABLE	Output	Transmitter Disable, Turns off transmitter laser output
80	SFP0_MOD2_SDA	Inout	SDA Serial Data Signal
81	3V3	Power	Power 3.3V
82	12V	Power	Power 12V
83	SFP0_MOD1_SCL	Output	SCL Serial Clock Signal
84	SFP0_MOD0_PRSENTn	Input	LED indicator that the module is present
85	SFP0_RATESEL	Output	Rate Select
86	SFP0_LOS	Input	Receiver Loss of Signal Indication
87	3V3	Power	Power 3.3V
88	12V	Power	Power 12V
89	SFP4_TDp	Output	Transmitter Non-Inverted Data Input
90	SFP4_RDp	Input	Receiver Non-Inverted Data Output
91	SFP4_TDn	Output	Transmitter Inverted Data Input
92	SFP4_RDn	Input	Receiver Inverted Data Output
93	3V3	Power	Power 3.3V
94	12V	Power	Power 12V
95	SFP4_TXFAULT	Input	Module Transmitter Fault
96	CLK1_p	Input	Differential Clock Input
97	SFP4_TXDISABLE	Output	Transmitter Disable, Turns off transmitter laser output
98	CLK1_n	Input	Differential Clock Input
99	3V3	Power	Power 3.3V
100	12V	Power	Power 12V
101	SFP4_MOD2_SDA	Inout	SDA Serial Data Signal
102	SFP4_MOD1_SCL	Output	SCL Serial Clock Signal
103	SFP4_MOD0_PRSENTn	Input	LED indicator that the module is present
104	SFP4_RATESEL	Output	Rate Select
105	3V3	Power	Power 3.3V
106	12V	Power	Power 12V
107	SFP4_LOS	Input	Receiver Loss of Signal Indication
108	SFP5_TXFAULT	Input	Module Transmitter Fault
109	SFP5_TXDISABLE	Output	Transmitter Disable, Turns off transmitter laser output
110	SFP5_MOD2_SDA	Inout	SDA Serial Data Signal
111	3V3	Power	Power 3.3V

Board Components

112	12V	Power	Power 12V
113	SFP5_TDp	Output	Transmitter Non-Inverted Data Input
114	SFP5_RDp	Input	Receiver Non-Inverted Data Output
115	SFP5_TDn	Output	Transmitter Inverted Data Input
116	SFP5_RDn	Input	Receiver Inverted Data Output
117	3V3	Power	Power 3.3V
118	12V	Power	Power 12V
119	SFP5_MOD1_SCL	Output	SCL Serial Clock Signal
120	SFP5_MOD0_PRSNTn	Input	Not Connect
121	SFP5_RATESEL	Output	Rate Select
122	SFP5_LOS.	Input	Receiver Loss of Signal Indication
123	3V3	Power	Power 3.3V
124	12V	Power	Power 12V
125	SFP6_TDp	Output	Transmitter Non-Inverted Data Input
126	SFP6_RDp	Input	Receiver Non-Inverted Data Output
127	SFP6_TDn	Output	Transmitter Inverted Data Input
128	SFP6_RDn	Input	Receiver Inverted Data Output
129	3V3	Power	Power 3.3V
130	12V	Power	Power 12V
131	SFP6_TXFAULT	Input	Module Transmitter Fault
132	SFP6_TXDISABLE	Output	Transmitter Disable, Turns off transmitter laser output
133	SFP6_MOD2_SDA	Inout	SDA Serial Data Signal
134	SFP6_MOD1_SCL	Output	SCL Serial Clock Signal
135	3V3	Power	Power 3.3V
136	12V	Power	Power 12V
137	SFP6_MOD0_PRSNTn	Input	LED indicator that the module is present
138	SFP6_RATESEL	Output	Rate Select
139	SFP6_LOS	Input	Receiver Loss of Signal Indication
140	SFP7_TXFAULT	Input	Module Transmitter Fault
141	3V3	Power	Power 3.3V
142	12V	Power	Power 12V
143	SFP7_TDp	Output	Transmitter Non-Inverted Data Input
144	SFP7_RDp	Input	Receiver Non-Inverted Data Output
145	SFP7_TDn	Output	Transmitter Inverted Data Input
146	SFP7_RDn	Input	Receiver Inverted Data Output
147	3V3	Power	Power 3.3V
148	12V	Power	Power 12V
149	SFP7_TXDISABLE	Output	Transmitter Disable, Turns off transmitter laser output

Board Components

150	SFP7_MOD2_SDA	Inout	SDA Serial Data Signal
151	SFP7_MOD1_SCL	Output	SCL Serial Clock Signal
152	SFP7_MOD0_PRSENTn	Input	LED indicator that the module is present
153	3V3	Power	Power 3.3V
154	12V	Power	Power 12V
155	SFP7_RATESEL	Output	Rate Select
156	CLK2_p	Input	Differential Clock Input
157	SFP7_LOS	Input	Receiver Loss of Signal Indication
158	CLK2_n	Input	Differential Clock Input
159	N.C.	N/A	Not Connect
160	GND	Power	Power Ground

3.2 Clock Circuitry

This section describes the board's clock inputs and outputs

LVDS clock frequencies of 61.44MHz, 125MHz, 155.52MHz, or 156.25MHz can be selected for HSMC CLK1p/CLK1n. CLK1p/CLK1n will be converted to a single-ended clock signal and output to an SMA.

LVDS clock frequencies of 125MHz, 155.52MHz, 156.25MHz, or SMA_CLKp/n can be selected for HSMC CLK2p/CLK2n pins. CLK2p/CLK2n will also be output directly to SMAs.

CLK_IN is a single-ended CMOS signal received by the daughter card from the FPGA and is cleaned-up with a frequency synthesizer. The cleaned-up clock is output to an LVPECL SMA pair.

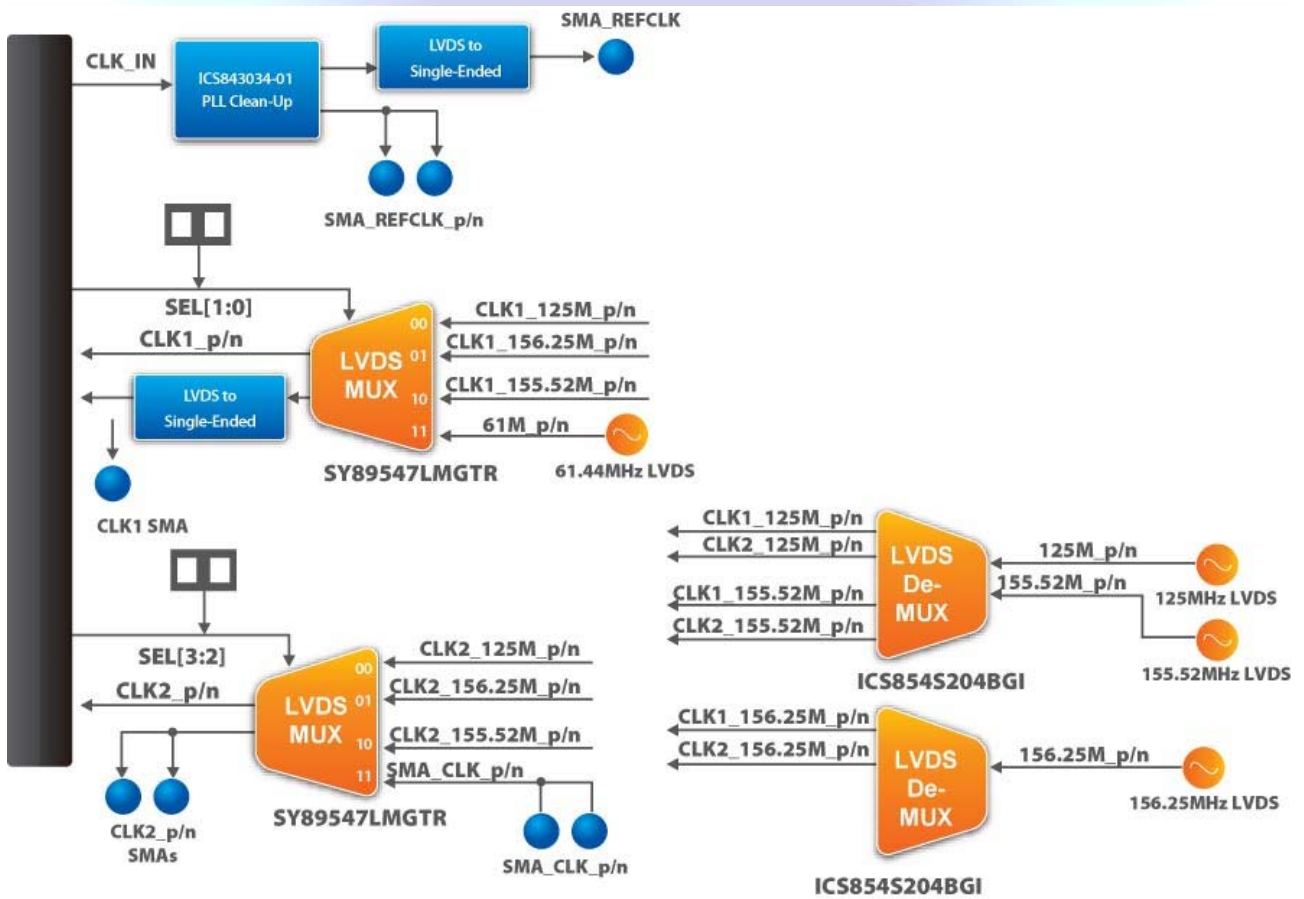

Figure 3.2 Clock Diagram

Table 3.2 CLK1 Settings

SEL [1:0]	CLK1p/CLK1n Frequency
11	125.00 MHz (Default)
10	155.52 MHz
01	156.25 MHz
00	61.44 MHz

Table 3.3 CLK2 Settings

SEL [3:2]	CLK2p/CLK2n Frequency
11	125.00 MHz (Default)
10	155.52 MHz
01	156.25 MHz
00	SMA_CLK_p/n

3.3 Power Supply

This section describes the power supply on the SFI HSMC board

The SFP HSMC is powered through the HSMC connector's 3.3V and 12V pins. The SFP and clocking circuitry requires 3.3V. A switching regulator powered from the 12V HSMC input produces 4V. Three linear regulators powered from 4V will produce the 3.3V. The switching frequency is set to 1MHz. The power distribution network is shown in the figure below. Max power consumption is estimated at 1A on 12V. Typical power consumption is considerably less than this.

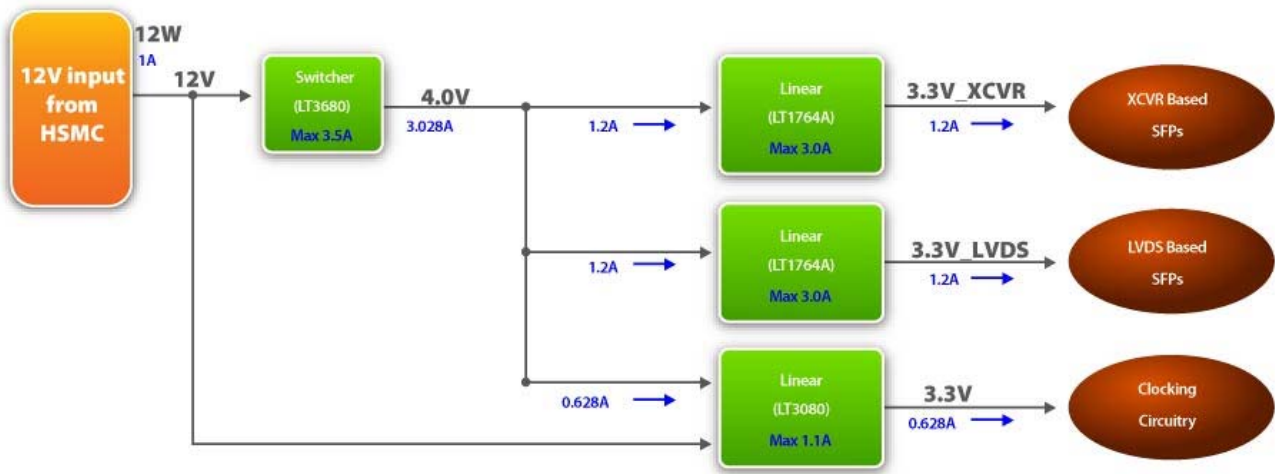

Figure 3.3 Power distribution on the SFP HSMC board

This Chapter illustrates the reference designs for the SFP HSMC board

4.1 Introduction

This section describes the functionality of the demonstration briefly.

The demonstration shows how to run the SFP HSMC loopback test for both Transceiver/LVDS based channels using the SFP HSMC daughter board and the Stratix IV GX FPGA Development board. The demonstration is intended for users to provide a basic introduction to the SFP HSMC daughter board with the procedure to control different hardware and software settings.

4.2 System Requirements

The following items are required for the HSMC-DVI Server demonstration.

- SFP HSMC x 1
- Stratix IV GX FPGA Development Board x 1
- SFP Loopback Connectors x 4

4.3 Setup the Demonstration

Figure 4.3 and 4.4 shows how to setup hardware for the SFP HSMC demonstration.

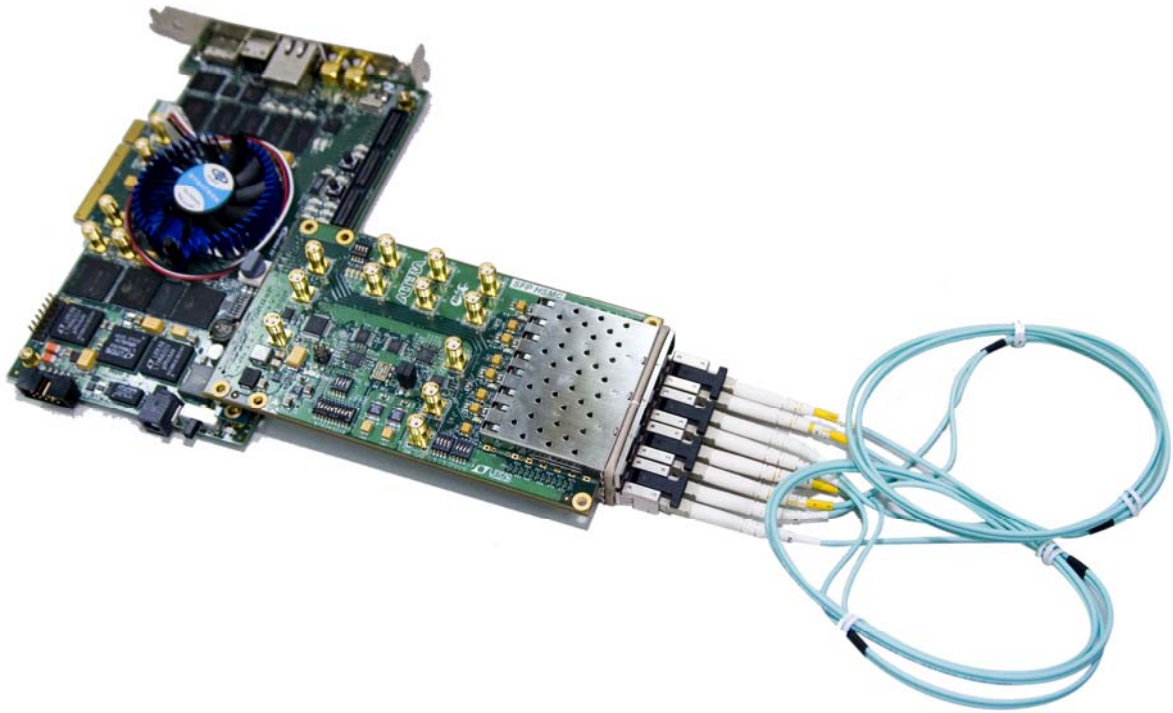

Figure 4.3 Transceiver Loopback Test Setup

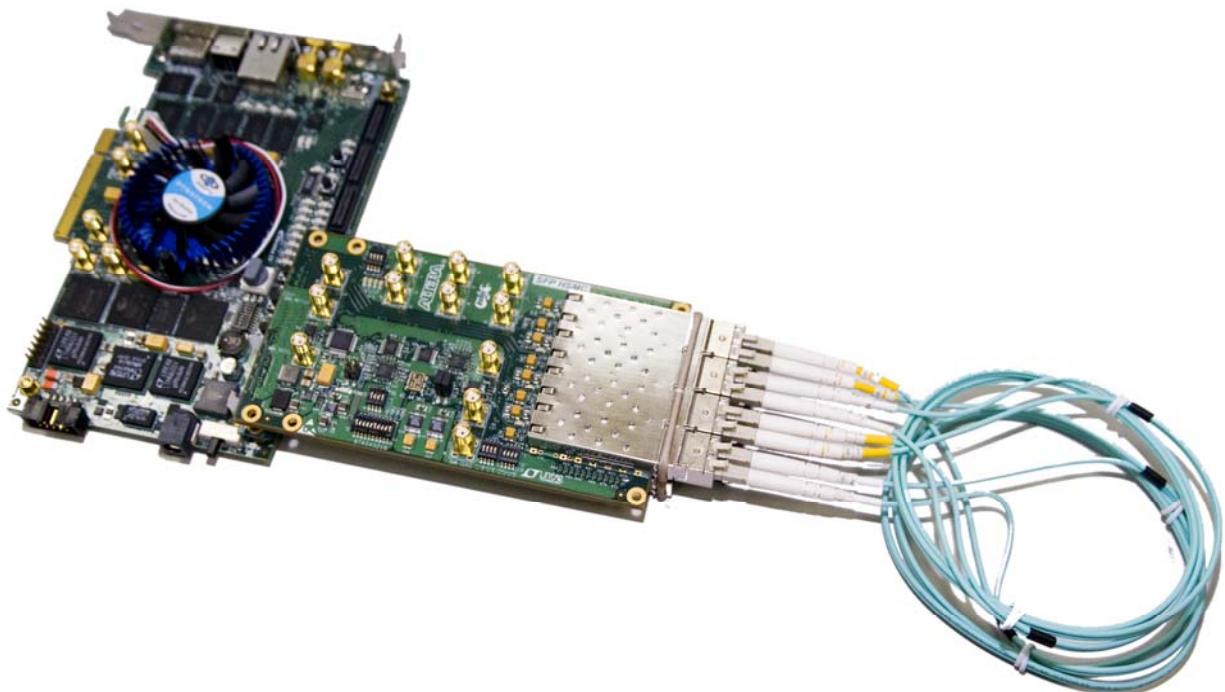

Figure 4.4 LVDS Loopback Test Setup

Note: The SFP HSMC board must be connected to HSMC Slot "B" of the Stratix IV GX FPGA Development Board for this demonstration

4.4 Demo Operation

This section describes the procedures of running the demonstration

FPGA Configuration

Demonstration Setup, File Locations, and Instructions

Transceiver Loopback Test Demo:

- Project directory: sfp_hsmb_s4gx_pcie_xcvr_loopback_6p25Gbps_restored
- Bit Stream used: hsmc_loopback.sof
- SFP HSMC Setup
 - ✓ Insert SFP modules with loopback connectors into SFP ports 0-3 on the SFP HSMC board
 - ✓ Set SW5 switches on the SFP HSMC all to the “0” position
- Stratix IV GX FPGA Development Kit Setup
 - ✓ Set SW3 switches 1-3 & 5-8 in the “down” position.
 - ✓ Set SW3 switch 4 in the “up” position
 - ✓ Set SW4 switches 1,2,4 in the “up” position and switches 3,5,6,8 in the “down” position
 - ✓ Set the rotary switch (SW2) to the 0 position
- Power on the Stratix IV GX FPGA Development Board and download the SOF file (hsmc_loopback.sof)
- Press and release CPU reset button located on the host board to initiate the test
- Press and release PB0, enabling comma detect
- Press and release PB1 enabling channel bonding
- Press and release PB2, start transmitting PRBS data
- LED0, LED1, and LED2 should be ON and LED3 should be OFF.
- Remove one of the SFP modules or one side of a connector so that the loopback will fail. A Failure is indicated on the Stratix IV GX FPGA Dev Kit when LED3 turns ON
- To reset the board test system, press and release the CPU reset button on the host board
- Press and release PB1 and PB2 at the same time creates an error in the transmitter data stream, where LED3 should be ON
- Press and release, the CPU reset button on the host board and verify the results

LVDS Loopback Test Demo:

- Project directory: sfp_hsmb_s4gx_pcie_lvds_loopback_restored
- Bit Stream used: hsmc_loopback.sof
- SFP HSMC Setup
 - ✓ Insert SFP modules with loopback connectors into SFP ports 4-7 on the SFP HSMC board
 - ✓ Set SW4 switches on the SFP HSMC all to the “1” position
- Stratix IV GX FPGA Development Kit Setup
 - ✓ Set SW3 switches 1-4 & 6-8 in the “down” position.
 - ✓ Set SW3 switch 5 in the “up” position
 - ✓ Set SW4 switches 1,2,4 in the “up” position and switches 3,5,6,8 in the “down” position

- ✓ Set the rotary switch (SW2) to the 0 position
- Power on the Stratix IV GX FPGA Development Board and download the SOF file (hsmc_loopback.sof)
- Press the CPU reset button located on the host board to initiate the test
- Press and release PB0, enabling comma detect
- Press and release PB1 enabling channel bonding
- Press and release PB2, start transmitting PRBS data
- LED0, LED1, and LED2 should be ON and LED3 should be OFF.
- Remove one of the SFP modules or one side of a connector so that the loopback will fail. A Failure is indicated on the Stratix IV GX FPGA Dev Kit when LED3 turns ON
- To reset the board test system, press and release the CPU reset button on the host board
- Press and release PB1 and PB2 at the same time creates an error in the transmitter data stream, where LED3 should be ON
- Press and release, the CPU reset button on the host board and verify the results

4.5 Overview

This section describes the design concepts for the SFP HSMC demonstration.

The demonstration is operating on Stratix GX Development Board HSMC Port B interface testing the four Transceiver/LVDS channels at 6.25Gbps. The transceiver signals HSMB[0:3] on the Stratix IV GX FPGA Development board are looped back through the SFP HSMC daughter board. The SFP HSMC board must have SFP modules inserted in SFP[0:3] locations with a loopback from SFP TX to SFP RX on each module. Four transceiver channels of pseudo-random data are 8B/10B encoded, serialized, pre-emphasized and transmitted out according to the following signals HSMB_TX_P/N[3:0] of the Stratix IV GX device at 6.25Gbps. These high-speed serial data are then looped back through an external SFP HSMC back to the Stratix IV GX device. Through the SFP HSMC board the data is then equalized, retimed, deserialized, word aligned, 8B/10B decoded, channel bonded, and then the four bonded channels are compared against a receive side PRBS generator inside the Stratix IV GX FPGA fabric.

The demonstration function block diagram is shown below in figure 4.5

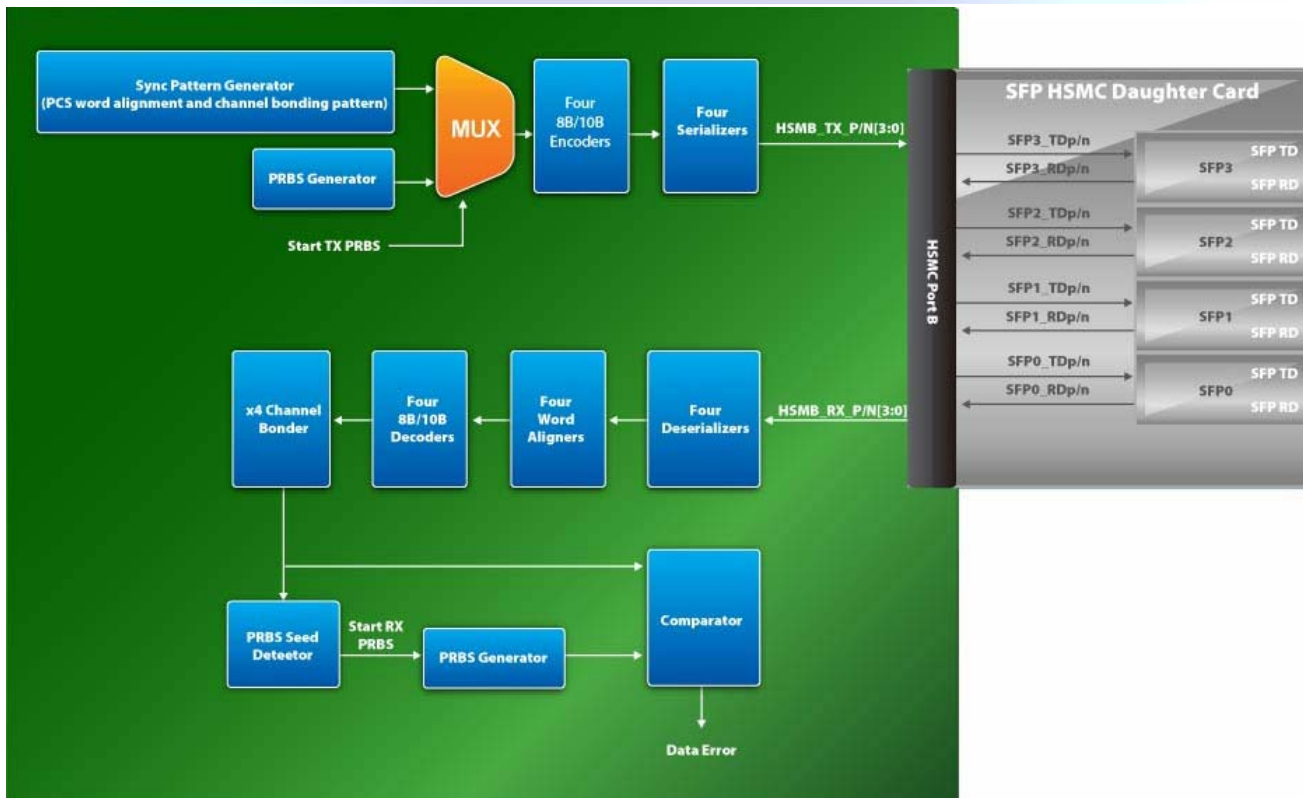

Figure 4.5 SFP Transceiver Test Block Diagram

Transceiver/LVDS Loopback Definitions

RESET – Resets the Board Test System

PB0 – Enable Comma Detect

PB1 – Enable Channel Bond

PB2 – Start Transmitting PRBS data

PB1 & PB2 – Pressing PB1 and PB2 at the same time creates an error in the transmitter data stream

USER_LED[0] – PLLs are locked

USER_LED[1] – Pattern Sync Acquired (Word aligned, Channel Bonded, 1st PRBS Data Received)

USER_LED[2] – Test Complete

USER_LED[3] – Error

USER_LED[15:4] – Heartbeat Pattern (Board is active)

5.1 Revision History

Date	Change Log
SEPT 1 , 2009	Initial Version
April 20 , 2013	Modify some board name

5.2 Always Visit SFP HSMC Webpage for New Main board

We will be continuing providing interesting examples and labs on our SFP HSMC

webpage. Please visit www.altera.com or hsmcsfp.terasic.com for more information.

X-ON Electronics

Largest Supplier of Electrical and Electronic Components

Click to view similar products for [Daughter Cards & OEM Boards](#) category:

Click to view products by [Terasic Technologies](#) manufacturer:

Other Similar products are found below :

[ADZS-21262-1-EZEXT 27911](#) [MPC5777C-416DS](#) [KITMPC5744DBEVM](#) [SPC56ELADPT144S](#) [TMDXRM46CNCD](#) [DM160216](#) [EV-ADUCM350GPIOTHZ](#) [EV-ADUCM350-BIO3Z](#) [ATSTK521 1130](#) [MA160015](#) [MA240013](#) [MA240026](#) [MA320014](#) [MA330014](#) [MA330017](#) [TMDSCNCD28054MISO](#) [MIKROE-2152](#) [MIKROE-2154](#) [MIKROE-2381](#) [TSSOP20EV](#) [MIKROE-1108](#) [MIKROE-1516](#) [SPS-READER-GEVK](#) [AC244049](#) [AC244050](#) [AC320004-3 2077](#) [ATSMARTCARD-XPRO](#) [EIC - Q600 -230](#) [ATZB-212B-XPRO](#) [SPC560PADPT100S](#) [SPC560BADPT64S](#) [MA180018](#) [EIC - Q600 -220](#) [AC164134-1](#) [BOB-12035](#) [BB-BONE-BATT-01](#) [STM8/128-D/RAIS](#) [AC164127-6](#) [AC164127-4](#) [AC164134-3](#) [AC164156](#) [MA320021](#) [MA320024](#) [DFR0285](#) [DFR0312](#) [DFR0356](#) [MA320023](#)