

TEWA TEMPERATURE SENSORS

HIGH PRECISION NTC THERMISTORS AND TEMPERATURE SENSORS

Specification of Temperature Probe

PART NUMBER: **TT4-G10KC8-T180-OM52-500**

No. of pages: 1

Date: **19.09.2019**

Revision: **00**

FEATURES:

Sensing Element	Glass Thermistor NTC
No-load resistance at 25°C	10 000 Ω
Tolerances at 25°C	± 1%
Beta(25/85) Constant	3 435K ±1%
Operating temperature range	-40°C ÷ 180°C
Test Voltage	500V DC
RoHS Compatible	YES

DRAWING:

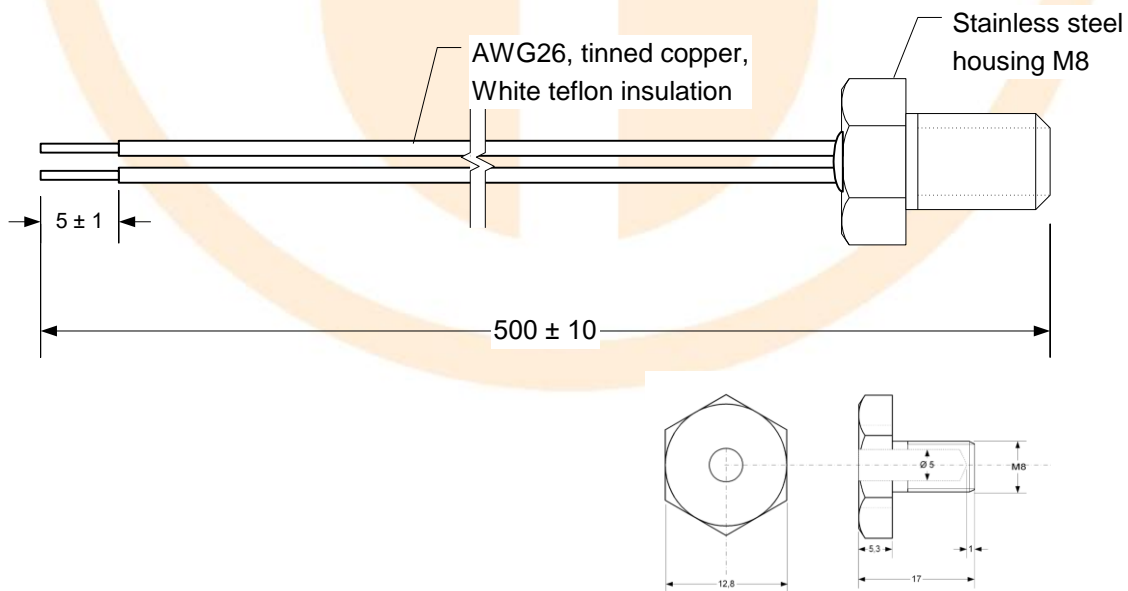

UNITS: [mm]

X-ON Electronics

Largest Supplier of Electrical and Electronic Components

Click to view similar products for TEWA TEMPERATURE SENSORS manufacturer:

Other Similar products are found below :

[TT02-10KC3-1D-T105-1500](#) [TT02-10KC8-1D-T105-1500](#) [TT02-PT1000B-1D-T105-1500](#) [TT02-PT100B-1D-T105-1500](#) [TT05-10KC3-1S-T105-1500](#) [TT05-10KC8-1S-T105-1500](#) [TT0P-10KC3-T105-1500](#) [TT0P-10KC8-T105-1500](#) [TT0P-PT1000B-T105-1500](#) [TT0P-PT100B-T105-1500](#) [TT2-100KC3H-7](#) [TT2-10KC3-10](#) [TT2-10KC3-13](#) [TT2-10KC8-13](#) [TT2-10KC8-3](#) [TT2-30KC5-3](#) [TT2-50.7KC3H-1](#) [TT2-50KC3-9](#) [TT2-5KC7-1](#) [TT4-10KC3-T105-OM55-1500](#) [TT4-10KC8-T105-OM55-1500](#) [TT4-G10KC3-T180-C312-200](#) [TT4-G10KC3-T180-OM52-500](#) [TT4-G10KC3-T80-OM54-500](#) [TT4-G10KC8-T180-C312-200](#) [TT4-G10KC8-T180-OM52-500](#) [TT4-G10KC8-T80-OM54-500](#) [TT4M-10KC3-T105-1500](#) [TT4M-10KC3-T125-M5-500](#) [TT4M-10KC8-T105-1500](#) [TT4M-10KC8-T125-M5-500](#) [TT4M-G10KC8-T200-1500](#) [TT4M-PT1000B-T125-M5-500](#) [TT4M-PT1000B-T200-1500](#) [TT4M-PT1000B-T350-1500](#) [TT4M-PT100B-T105-1500](#) [TT4M-PT100B-T125-M5-500](#) [TT4M-PT100B-T200-1500](#) [TT4M-PT100B-T350-1500](#) [TT4-PT1000B-T105-OM55-1500](#) [TT4-PT1000B-T180-OM52-500](#) [TT4-PT100B-T105-OM55-1500](#) [TT4-PT100B-T180-C312-200](#) [TT4-PT100B-T180-OM52-500](#) [TT6-100KC3L-5-AUR](#) [TT6-10KC8-9-25](#) [TT6-10KC8-9-50](#) [TT7-0.73KC7-1](#) [TT7-0.88KC7-1](#) [TT7-100KC3-3](#)