

ADC128S052, ADC128S052-Q1 8-Channel, 200 kSPS to 500 kSPS, 12-Bit A/D Converter

1 Features

- Qualified for Automotive Applications
- AEC-Q100 Qualified With the Following Results:
 - Device Temperature Grade 1: -40°C to $+125^{\circ}\text{C}$ Ambient Operating Temperature Range
- Eight Input Channels
- Variable Power Management
- Independent Analog and Digital Supplies
- Compatible With SPI™, QSPI™, MICROWIRE, and DSP
- Packaged in 16-Pin TSSOP
- Conversion Rate 200 kSPS to 500 kSPS
- DNL ($V_A = V_D = 5\text{ V}$) + 1.3 or -0.9 LSB (Maximum)
- INL ($V_A = V_D = 5\text{ V}$) $\pm 1\text{ LSB}$ (Maximum)
- Power Consumption
 - 3-V Supply 1.6 mW (Typical)
 - 5-V Supply 8.7 mW (Typical)

2 Applications

- Automotive Navigation
- Portable Systems
- Medical Instruments
- Mobile Communications
- Instrumentation and Control Systems

3 Description

The ADC128S052x device is a low-power, eight-channel CMOS 12-bit analog-to-digital converter specified for conversion throughput rates of 200 kSPS to 500 kSPS. The converter is based on a successive-approximation register architecture with an internal track-and-hold circuit. It can be configured to accept up to eight input signals at inputs IN0 through IN7.

The output serial data is straight binary and is compatible with several standards, such as SPI, QSPI, MICROWIRE, and many common DSP serial interfaces.

The ADC128S052x may be operated with independent analog and digital supplies. The analog supply (V_A) can range from 2.7 V to 5.25 V, and the digital supply (V_D) can range from 2.7 V to V_A . Normal power consumption using a 3-V or 5-V supply is 1.6 mW and 8.7 mW, respectively. The power-down feature reduces the power consumption to 0.06 μW using a 3-V supply and 0.25 μW using a 5-V supply.

The ADC128S052x is packaged in a 16-pin TSSOP package. The ADC128S052 is ensured over the extended industrial temperature range of -40°C to $+105^{\circ}\text{C}$ while the ADC128S052-Q1 is ensured to an AECQ100 Grade-1 automotive temperature range of -40°C to $+125^{\circ}\text{C}$.

Device Information⁽¹⁾

PART NUMBER	PACKAGE	BODY SIZE (NOM)
ADC128S052, ADC128S052-Q1	TSSOP (16)	4.40 mm x 5.00 mm

(1) For all available packages, see the orderable addendum at the end of the data sheet.

Simplified Schematic

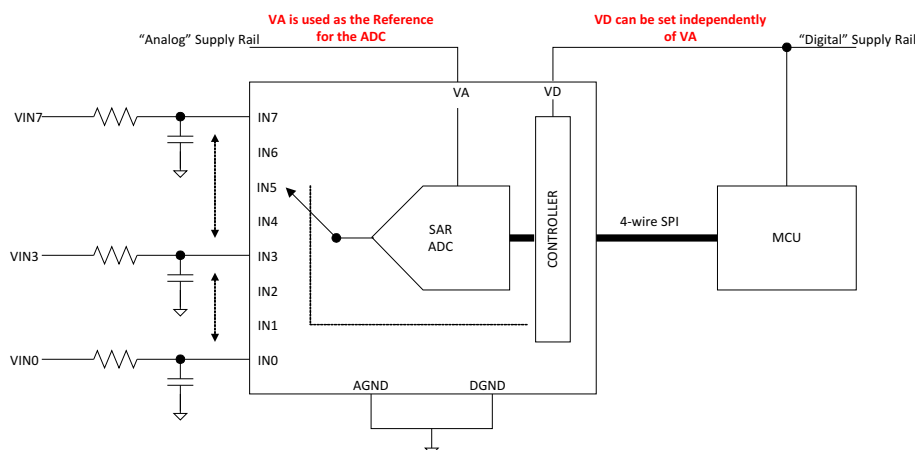

Table of Contents

1 Features	1	7.5 Programming.....	17
2 Applications	1	7.6 Register Maps	18
3 Description	1	8 Application and Implementation	19
4 Revision History	2	8.1 Application Information.....	19
5 Pin Configuration and Functions	3	8.2 Typical Application	20
6 Specifications	4	9 Power Supply Recommendations	22
6.1 Absolute Maximum Ratings	4	9.1 Power Supply Sequence.....	22
6.2 ESD Ratings – Commercial	4	9.2 Power Supply Noise Considerations.....	22
6.3 ESD Ratings – Automotive	4	10 Layout	23
6.4 Recommended Operating Conditions	5	10.1 Layout Guidelines	23
6.5 Thermal Information	5	10.2 Layout Example	23
6.6 Electrical Characteristics	5	11 Device and Documentation Support	24
6.7 Timing Specifications	8	11.1 Device Support	24
6.8 Typical Characteristics	9	11.2 Related Links	25
7 Detailed Description	15	11.3 Community Resources.....	26
7.1 Overview	15	11.4 Trademarks	26
7.2 Functional Block Diagram	15	11.5 Electrostatic Discharge Caution.....	26
7.3 Feature Description.....	15	11.6 Glossary	26
7.4 Device Functional Modes.....	16	12 Mechanical, Packaging, and Orderable Information	26

4 Revision History

NOTE: Page numbers for previous revisions may differ from page numbers in the current version.

Changes from Revision D (March 2013) to Revision E	Page
<ul style="list-style-type: none">Added <i>Device Information</i> table, <i>ESD Ratings</i> table, <i>Thermal Information</i> table, <i>Feature Description</i> section, <i>Device Functional Modes</i>, <i>Application and Implementation</i> section, <i>Power Supply Recommendations</i> section, <i>Layout</i> section, <i>Device and Documentation Support</i> section, and <i>Mechanical, Packaging, and Orderable Information</i> section.....	1

Changes from Revision C (March 2013) to Revision D	Page
<ul style="list-style-type: none">Changed layout of National Data Sheet to TI format	23

5 Pin Configuration and Functions

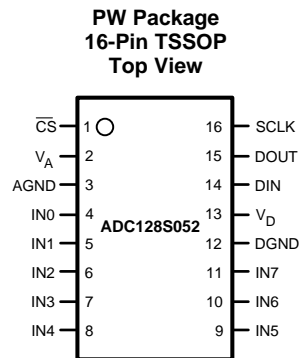

Pin Functions

PIN		TYPE	DESCRIPTION
NO.	NAME		
1	\overline{CS}	Digital I/O	Chip select. On the falling edge of \overline{CS} , a conversion process begins. Conversions continue as long as \overline{CS} is held low.
2	V_A	Power Supply	Positive analog supply pin. This voltage is also used as the reference voltage. This pin must be connected to a quiet 2.7-V to 5.25-V source and bypassed to GND with 1- μ F and 0.1- μ F monolithic ceramic capacitors located within 1 cm of the power pin.
3	AGND	Power Supply	The ground return for the analog supply and signals.
4	IN0 to IN7	Analog I/O	Analog inputs. These signals can range from 0 V to V_{REF} .
5			
6			
7			
8			
9			
10			
11			
12	DGND	Power Supply	The ground return for the digital supply and signals.
13	V_D	Power Supply	Positive digital supply pin. This pin must be connected to a 2.7-V to V_A supply, and bypassed to GND with a 0.1- μ F monolithic ceramic capacitor located within 1 cm of the power pin.
14	DIN	Digital I/O	Digital data input. The control register of the ADC128S052 is loaded through this pin on rising edges of the SCLK pin.
15	DOUT	Digital I/O	Digital data output. The output samples are clocked out of this pin on the falling edges of the SCLK pin.
16	SCLK	Digital I/O	Digital clock input. The ensured performance range of frequencies for this input is 3.2 MHz to 8 MHz. This clock directly controls the conversion and readout processes.

6 Specifications

6.1 Absolute Maximum Ratings

 See ⁽¹⁾⁽²⁾⁽³⁾

	MIN	MAX	UNIT
Analog Supply Voltage V_A	-0.3	6.5	V
Digital Supply Voltage V_D	-0.3	$V_A + 0.3$, max 6.5	V
Voltage on Any Pin to GND	-0.3	$V_A + 0.3$	V
Input Current at Any Pin ⁽⁴⁾		± 10	mA
Package Input Current ⁽⁴⁾		± 20	mA
Power Dissipation at $T_A = 25^\circ\text{C}$		See ⁽⁵⁾	
Junction Temperature		+150	$^\circ\text{C}$
Storage Temperature, T_{stg}	-65	150	$^\circ\text{C}$

- Stresses beyond those listed under *Absolute Maximum Ratings* may cause permanent damage to the device. These are stress ratings only, which do not imply functional operation of the device at these or any other conditions beyond those indicated under *Recommended Operating Conditions*. Exposure to absolute-maximum-rated conditions for extended periods may affect device reliability.
- If Military/Aerospace specified devices are required, contact the TI Sales Office/Distributors for availability and specifications.
- For soldering specifications: see product folder at www.ti.com and [SNOA549](#).
- When the input voltage at any pin exceeds the power supplies (that is, $V_{\text{IN}} < \text{AGND}$ or $V_{\text{IN}} > V_A$ or V_D), the current at that pin must be limited to 10 mA. The 20-mA maximum package input current rating limits the number of pins that can safely exceed the power supplies with an input current of 10 mA to two.
- The absolute maximum junction temperature (T_{JMAX}) for this device is 150°C . The maximum allowable power dissipation is dictated by T_{JMAX} , the junction-to-ambient thermal resistance ($R_{\theta\text{JA}}$), and the ambient temperature (T_A), and can be calculated using the formula $P_{\text{DMAX}} = (T_{\text{JMAX}} - T_A)/R_{\theta\text{JA}}$. In the 16-pin TSSOP, $R_{\theta\text{JA}}$ is $110^\circ\text{C}/\text{W}$, so $P_{\text{DMAX}} = 1,200 \text{ mW}$ at 25°C and 625 mW at the maximum operating ambient temperature of 105°C . Note that the power consumption of this device under normal operation is a maximum of 12 mW. The values for maximum power dissipation listed above is reached only when the ADC128S052 is operated in a severe fault condition (for example, when input or output pins are driven beyond the power supply voltages, or the power supply polarity is reversed). Such conditions must always be avoided.

6.2 ESD Ratings – Commercial

		VALUE	UNIT
$V_{\text{(ESD)}}$	Electrostatic discharge	Human body model (HBM), per ANSI/ESDA/JEDEC JS-001 ⁽¹⁾⁽²⁾	± 2500
		Machine model (MM) ⁽³⁾	± 250

- JEDEC document JEP155 states that 500-V HBM allows safe manufacturing with a standard ESD control process.
- Human body model is a 100-pF capacitor discharged through a 1.5-k Ω resistor.
- Machine model is a 220-pF discharged through ZERO Ω .

6.3 ESD Ratings – Automotive

		VALUE	UNIT
$V_{\text{(ESD)}}$	Electrostatic discharge	Human-body model (HBM), per AEC Q100-002 ⁽¹⁾	± 2500
		Charged-device model (CDM), per AEC Q100-011	± 250

- AEC Q100-002 indicates that HBM stressing shall be in accordance with the ANSI/ESDA/JEDEC JS-001 specification.

6.4 Recommended Operating Conditions

 See ⁽¹⁾

		MIN	NOM	MAX	UNIT
Operating Temperature	ADC128S052	-40	T _A	105	°C
	ADC128S052-Q1	-40	T _A	125	°C
V _A Supply Voltage		2.7		5.25	V
V _D Supply Voltage		2.7		V _A	V
Digital Input Voltage		0		V _A	V
Analog Input Voltage		0		V _A	V
Clock Frequency		50		1600	kHz

⁽¹⁾ All voltages are measured with respect to GND = 0 V, unless otherwise specified.

6.5 Thermal Information

THERMAL METRIC ⁽¹⁾		ADC128S052, ADC128S052-Q1		UNIT
		PW (TSSOP)		
		16 PINS		
R _{θJA}	Junction-to-ambient thermal resistance	110		°C/W
R _{θJC(top)}	Junction-to-case (top) thermal resistance	42		°C/W
R _{θJB}	Junction-to-board thermal resistance	56		°C/W
Ψ _{JT}	Junction-to-top characterization parameter	5		°C/W
Ψ _{JB}	Junction-to-board characterization parameter	55		°C/W

⁽¹⁾ For more information about traditional and new thermal metrics, see the *Semiconductor and IC Package Thermal Metrics* application report, [SPRA953](#).

6.6 Electrical Characteristics

 The following specifications apply for AGND = DGND = 0 V, f_{SCLK} = 3.2 MHz to 8 MHz, f_{SAMPLE} = 200 kSPS to 500 kSPS, C_L = 50 pF, unless otherwise noted. Maximum and minimum limits apply for T_A = T_{MIN} to T_{MAX}; all other limits T_A = 25°C.⁽¹⁾

PARAMETER	TEST CONDITIONS	MIN	TYP	MAX ⁽²⁾	UNIT
STATIC CONVERTER CHARACTERISTICS					
	Resolution with No Missing Codes			12	Bits
INL	Integral Non-Linearity (End Point Method)	V _A = V _D = 3 V	±0.3	±1	LSB
		V _A = V _D = 5 V	±0.4	±1	LSB
DNL	Differential Non-Linearity	V _A = V _D = 3 V	-0.7	0.3	0.9
			-0.2		LSB
		V _A = V _D = 5 V		0.6	1.3
		-0.9	-0.4		LSB
V _{OFF}	Offset Error	V _A = V _D = 3 V		0.8	±2.3
		V _A = V _D = 5 V		1.2	±2.3
OEM	Offset Error Match	V _A = V _D = 3 V	±0.05	±1.5	LSB
		V _A = V _D = 5 V	±0.2	±1.5	LSB
FSE	Full Scale Error	V _A = V _D = 3 V	0.6	±2.0	LSB
		V _A = V _D = 5 V	0.3	±2.0	LSB
FSEM	Full Scale Error Match	V _A = V _D = 3 V	±0.05	±1.5	LSB
		V _A = V _D = 5 V	±0.2	±1.5	LSB

⁽¹⁾ Data sheet minimum and maximum specification limits are ensured by design, test, or statistical analysis.

⁽²⁾ Tested limits are ensured to TI's AOQL (Average Outgoing Quality Level).

Electrical Characteristics (continued)

The following specifications apply for AGND = DGND = 0 V, $f_{SCLK} = 3.2 \text{ MHz to } 8 \text{ MHz}$, $f_{SAMPLE} = 200 \text{ kSPS to } 500 \text{ kSPS}$, $C_L = 50 \text{ pF}$, unless otherwise noted. Maximum and minimum limits apply for $T_A = T_{MIN}$ to T_{MAX} : all other limits $T_A = 25^\circ\text{C}$.⁽¹⁾

PARAMETER		TEST CONDITIONS	MIN	TYP	MAX ⁽²⁾	UNIT
DYNAMIC CONVERTER CHARACTERISTICS						
FPBW	Full Power Bandwidth (-3 dB)	$V_A = V_D = 3 \text{ V}$		8		MHz
		$V_A = V_D = 5 \text{ V}$		11		MHz
SINAD	Signal-to-Noise Plus Distortion Ratio	$V_A = V_D = 3 \text{ V}$, $f_{IN} = 40.2 \text{ kHz}$, -0.02 dBFS	70	73		dB
		$V_A = V_D = 5 \text{ V}$, $f_{IN} = 40.2 \text{ kHz}$, -0.02 dBFS	70	73		dB
SNR	Signal-to-Noise Ratio	$V_A = V_D = 3 \text{ V}$, $f_{IN} = 40.2 \text{ kHz}$, -0.02 dBFS	70.8	73		dB
		$V_A = V_D = 5 \text{ V}$, $f_{IN} = 40.2 \text{ kHz}$, -0.02 dBFS	70.8	73		dB
THD	Total Harmonic Distortion	$V_A = V_D = 3 \text{ V}$, $f_{IN} = 40.2 \text{ kHz}$, -0.02 dBFS		-90	-74	dB
		$V_A = V_D = 5 \text{ V}$, $f_{IN} = 40.2 \text{ kHz}$, -0.02 dBFS		-89	-74	dB
SFDR	Spurious-Free Dynamic Range	$V_A = V_D = 3 \text{ V}$, $f_{IN} = 40.2 \text{ kHz}$, -0.02 dBFS	75	92		dB
		$V_A = V_D = 5 \text{ V}$, $f_{IN} = 40.2 \text{ kHz}$, -0.02 dBFS	75	91		dB
ENOB	Effective Number of Bits	$V_A = V_D = 3 \text{ V}$, $f_{IN} = 40.2 \text{ kHz}$	11.3	11.8		Bits
		$V_A = V_D = 5 \text{ V}$, $f_{IN} = 40.2 \text{ kHz}$, -0.02 dBFS	11.3	11.8		Bits
ISO	Channel-to-Channel Isolation	$V_A = V_D = 3 \text{ V}$, $f_{IN} = 20 \text{ kHz}$		81		dB
		$V_A = V_D = 5 \text{ V}$, $f_{IN} = 20 \text{ kHz}$, -0.02 dBFS		81		dB
IMD	Intermodulation Distortion, Second Order Terms	$V_A = V_D = 3 \text{ V}$, $f_a = 19.5 \text{ kHz}$, $f_b = 20.5 \text{ kHz}$		-98		dB
		$V_A = V_D = 5 \text{ V}$, $f_a = 19.5 \text{ kHz}$, $f_b = 20.5 \text{ kHz}$		-91		dB
	Intermodulation Distortion, Third Order Terms	$V_A = V_D = 3 \text{ V}$, $f_a = 19.5 \text{ kHz}$, $f_b = 20.5 \text{ kHz}$		-89		dB
		$V_A = V_D = 5 \text{ V}$, $f_a = 19.5 \text{ kHz}$, $f_b = 20.5 \text{ kHz}$		-88		dB
ANALOG INPUT CHARACTERISTICS						
V_{IN}	Input Range		0		V_A	V
I_{DCL}	DC Leakage Current				±1	µA
C_{INA}	Input Capacitance	Track Mode		33		pF
		Hold Mode		3		pF
DIGITAL INPUT CHARACTERISTICS						
V_{IH}	Input High Voltage	$V_A = V_D = 2.7 \text{ V to } 3.6 \text{ V}$	2.1			V
		$V_A = V_D = 4.75 \text{ V to } 5.25 \text{ V}$	2.4			V
V_{IL}	Input Low Voltage	$V_A = V_D = 2.7 \text{ V to } 5.25 \text{ V}$			0.8	V
I_{IN}	Input Current	$V_{IN} = 0 \text{ V or } V_D$		±0.01	±1	µA
C_{IND}	Digital Input Capacitance			2	4	pF

Electrical Characteristics (continued)

The following specifications apply for AGND = DGND = 0 V, $f_{SCLK} = 3.2$ MHz to 8 MHz, $f_{SAMPLE} = 200$ kSPS to 500 kSPS, $C_L = 50$ pF, unless otherwise noted. Maximum and minimum limits apply for $T_A = T_{MIN}$ to T_{MAX} ; all other limits $T_A = 25^\circ\text{C}$.⁽¹⁾

PARAMETER		TEST CONDITIONS	MIN	TYP	MAX ⁽²⁾	UNIT	
DIGITAL OUTPUT CHARACTERISTICS							
V_{OH}	Output High Voltage	$I_{SOURCE} = 200 \mu\text{A}$, $V_A = V_D = 2.7 \text{ V to } 5.25 \text{ V}$	$V_D - 0.5$			V	
V_{OL}	Output Low Voltage	$I_{SINK} = 200 \mu\text{A to } 1.0 \text{ mA}$, $V_A = V_D = 2.7 \text{ V to } 5.25 \text{ V}$			0.4	V	
I_{OZH} , I_{OZL}	Hi-Impedance Output Leakage Current	$V_A = V_D = 2.7 \text{ V to } 5.25 \text{ V}$			± 1	μA	
C_{OUT}	Hi-Impedance Output Capacitance ⁽¹⁾			2	4	pF	
	Output Coding		Straight (Natural) Binary				
POWER SUPPLY CHARACTERISTICS ($C_L = 10$ pF)							
V_A, V_D	Analog and Digital Supply Voltages	$V_A \geq V_D$	2.7		5.25	V	
$I_A + I_D$	Total Supply Current Normal Mode (\overline{CS} low)	$V_A = V_D = 2.7 \text{ V to } 3.6 \text{ V}$, $f_{SAMPLE} = 500 \text{ kSPS}$, $f_{IN} = 40 \text{ kHz}$		0.54	1.2	mA	
		$V_A = V_D = 4.75 \text{ V to } 5.25 \text{ V}$, $f_{SAMPLE} = 500 \text{ kSPS}$, $f_{IN} = 40 \text{ kHz}$		1.74	2.6	mA	
	Total Supply Current Shutdown Mode (\overline{CS} high)	$V_A = V_D = 2.7 \text{ V to } 3.6 \text{ V}$, $f_{SCLK} = 0 \text{ kSPS}$		20			nA
		$V_A = V_D = 4.75 \text{ V to } 5.25 \text{ V}$, $f_{SCLK} = 0 \text{ kSPS}$		50			nA
P_C	Power Consumption Normal Mode (\overline{CS} low)	$V_A = V_D = 3 \text{ V}$, $f_{SAMPLE} = 500 \text{ kSPS}$, $f_{IN} = 40 \text{ kHz}$		1.6	3.6	mW	
		$V_A = V_D = 5.0 \text{ V}$, $f_{SAMPLE} = 500 \text{ kSPS}$, $f_{IN} = 40 \text{ kHz}$		8.7	13.0	mW	
	Power Consumption Shutdown Mode (\overline{CS} high)	$V_A = V_D = 3 \text{ V}$, $f_{SCLK} = 0 \text{ kSPS}$		0.06			μW
		$V_A = V_D = 5 \text{ V}$, $f_{SCLK} = 0 \text{ kSPS}$		0.25			μW
AC ELECTRICAL CHARACTERISTICS							
f_{SCLK}^{MIN}	Minimum Clock Frequency	$V_A = V_D = 2.7 \text{ V to } 5.25 \text{ V}$	3.2	0.8		MHz	
f_{SCLK}	Maximum Clock Frequency	$V_A = V_D = 2.7 \text{ V to } 5.25 \text{ V}$		16	8	MHz	
f_S	Sample Rate Continuous Mode	$V_A = V_D = 2.7 \text{ V to } 5.25 \text{ V}$	200	50		kSPS	
				1000	500	kSPS	
$t_{CONVERT}$	Conversion (Hold) Time	$V_A = V_D = 2.7 \text{ V to } 5.25 \text{ V}$			13	SCLK cycles	
DC	SCLK Duty Cycle	$V_A = V_D = 2.7 \text{ V to } 5.25 \text{ V}$	40%	30%			
				70%	60%		
t_{ACQ}	Acquisition (Track) Time	$V_A = V_D = 2.7 \text{ V to } 5.25 \text{ V}$			3	SCLK cycles	
	Throughput Time	Acquisition Time + Conversion Time $V_A = V_D = 2.7 \text{ V to } 5.25 \text{ V}$			16	SCLK cycles	
t_{AD}	Aperture Delay	$V_A = V_D = 2.7 \text{ V to } 5.25 \text{ V}$		4		ns	

6.7 Timing Specifications

The following specifications apply for $V_A = V_D = 2.7\text{ V}$ to 5.25 V , $AGND = DGND = 0\text{ V}$, $f_{SCLK} = 3.2\text{ MHz}$ to 8 MHz , $f_{SAMPLE} = 200\text{ kSPS}$ to 500 kSPS , and $C_L = 50\text{ pF}$. Maximum and minimum limits apply for $T_A = T_{MIN}$ to T_{MAX} ; all other limits $T_A = 25^\circ\text{C}$. See [Figure 1](#), [Figure 2](#), and [Figure 3](#).

		MIN	NOM	MAX ⁽¹⁾	UNIT
t_{CSH}	\overline{CS} Hold Time after SCLK Rising Edge	10	0		ns
t_{CSS}	\overline{CS} Set-up Time prior to SCLK Rising Edge	10	4.5		ns
t_{EN}	\overline{CS} Falling Edge to DOUT enabled		5	30	ns
t_{DACC}	DOUT Access Time after SCLK Falling Edge		17	27	ns
$t_{DHL D}$	DOUT Hold Time after SCLK Falling Edge		4		ns
t_{DS}	DIN Set-up Time prior to SCLK Rising Edge	10	3		ns
t_{DH}	DIN Hold Time after SCLK Rising Edge	10	3		ns
t_{CH}	SCLK High Time	$0.4 \times t_{SCLK}$			ns
t_{CL}	SCLK Low Time	$0.4 \times t_{SCLK}$			ns
t_{DIS}	\overline{CS} Rising Edge to DOUT High-Impedance	DOUT falling	2.4	20	ns
		DOUT rising	0.9	20	ns

(1) Tested limits are ensured to TI's AOQL (Average Outgoing Quality Level).

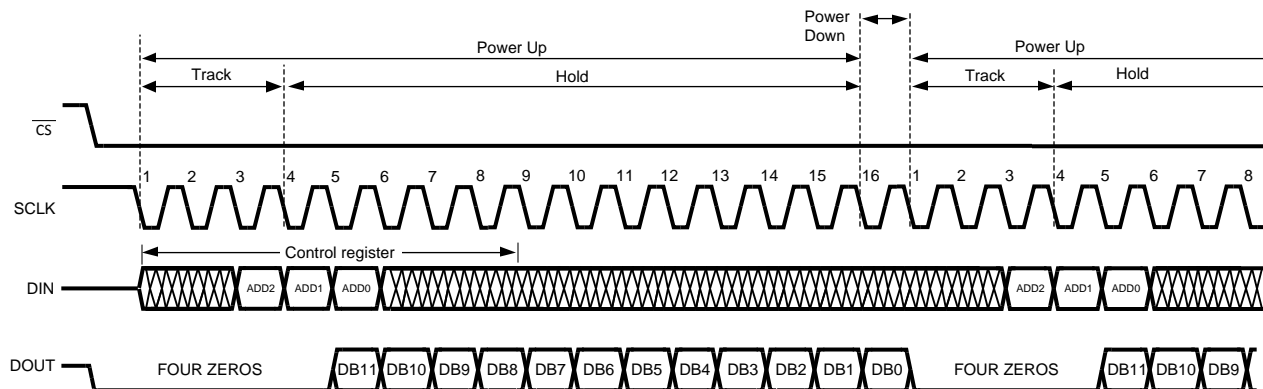

Figure 1. ADC128S052 Operational Timing Diagram

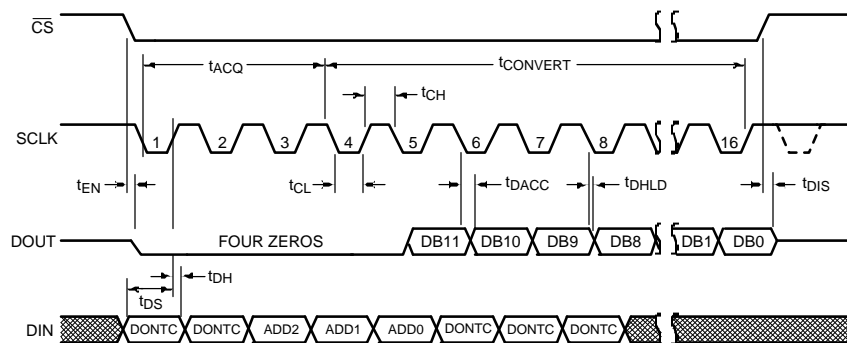

Figure 2. ADC128S052 Serial Timing Diagram

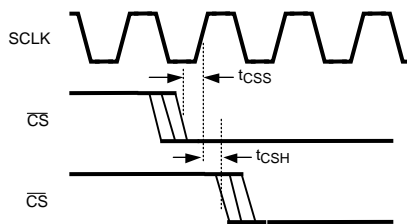

Figure 3. SCLK and CS Timing Parameters

6.8 Typical Characteristics

$T_A = 25^\circ\text{C}$, $f_{\text{SAMPLE}} = 500 \text{ kSPS}$, $f_{\text{SCLK}} = 8 \text{ MHz}$, $f_{\text{IN}} = 40.2 \text{ kHz}$ unless otherwise stated

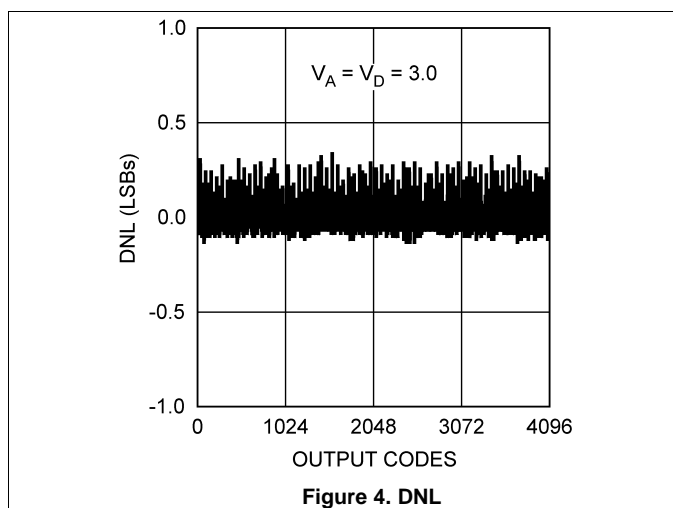

Figure 4. DNL

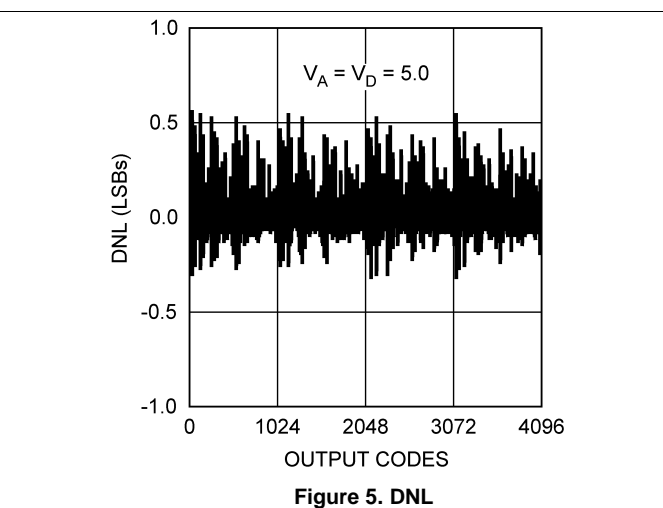

Figure 5. DNL

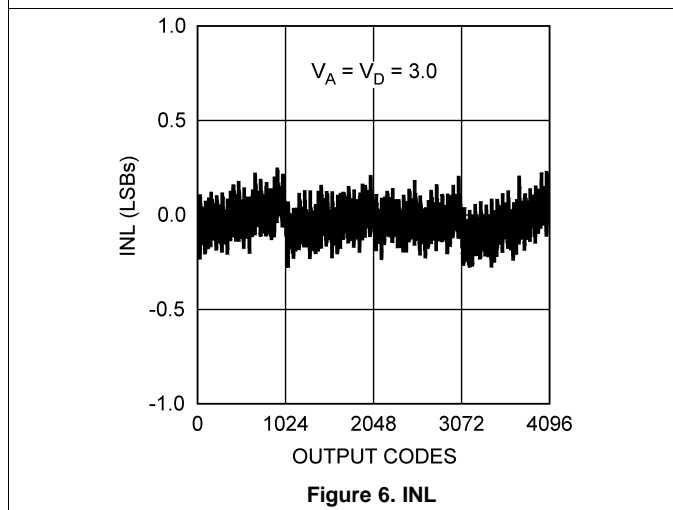

Figure 6. INL

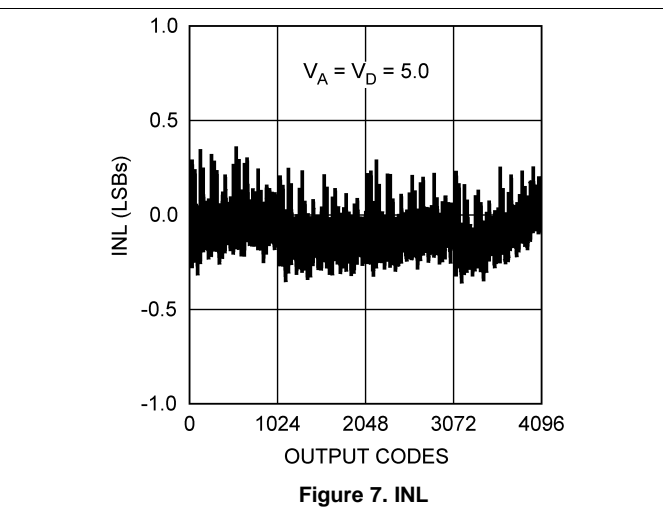
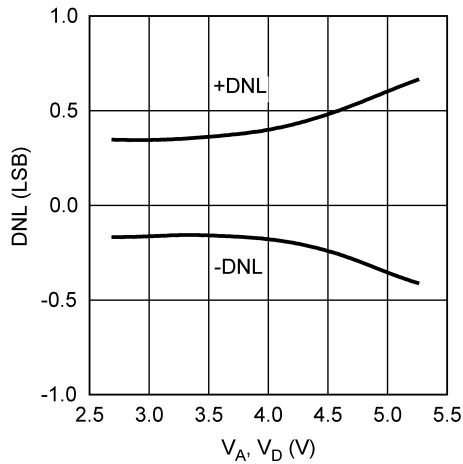
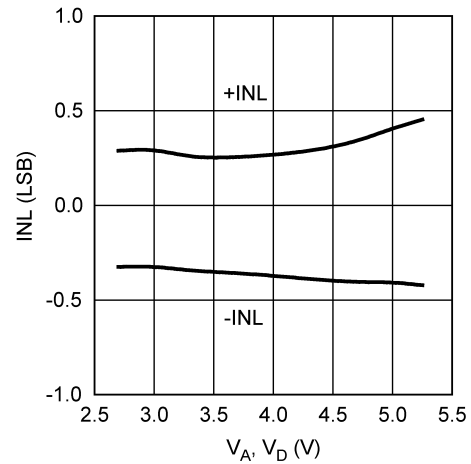
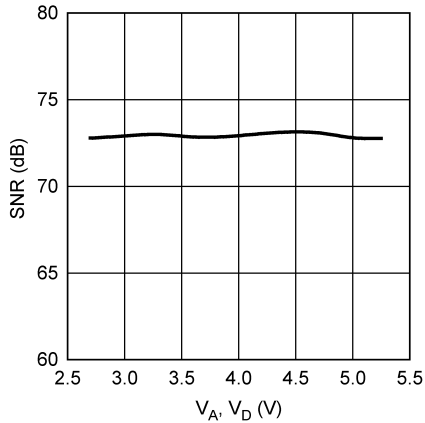
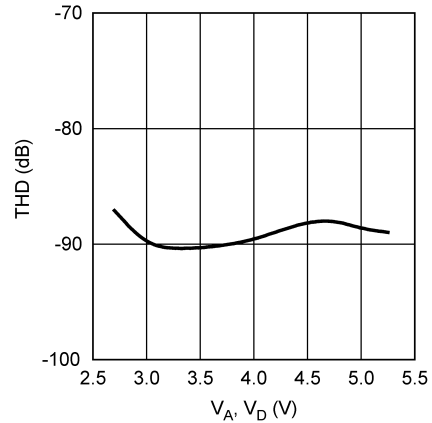
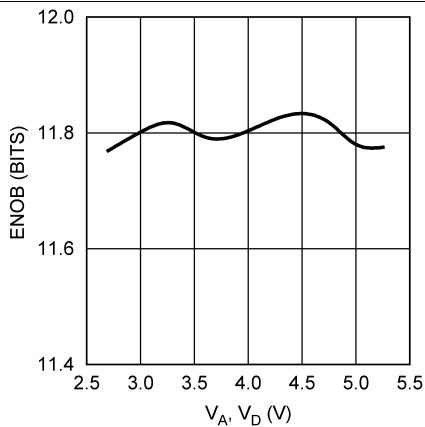
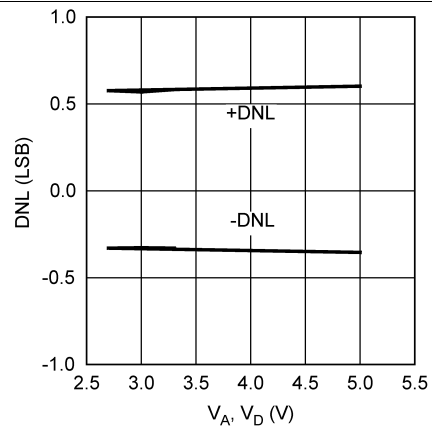

Figure 7. INL

Typical Characteristics (continued)
 $T_A = 25^\circ\text{C}$, $f_{\text{SAMPLE}} = 500 \text{ kSPS}$, $f_{\text{SCLK}} = 8 \text{ MHz}$, $f_{\text{IN}} = 40.2 \text{ kHz}$ unless otherwise stated

Figure 8. DNL vs Supply

Figure 9. INL vs Supply

Figure 10. SNR vs Supply

Figure 11. THD vs Supply

Figure 12. ENOB vs Supply

 $V_A = 5 \text{ V}$
Figure 13. DNL vs V_D

Typical Characteristics (continued)

$T_A = 25^\circ\text{C}$, $f_{\text{SAMPLE}} = 500 \text{ kSPS}$, $f_{\text{SCLK}} = 8 \text{ MHz}$, $f_{\text{IN}} = 40.2 \text{ kHz}$ unless otherwise stated

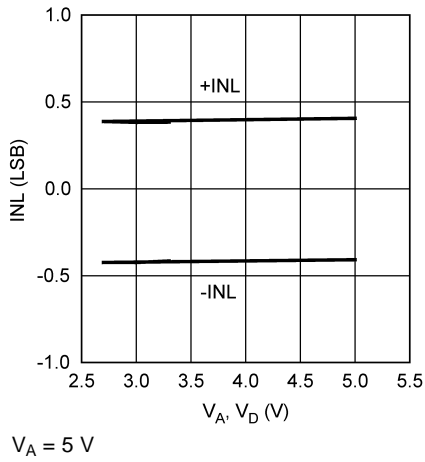

Figure 14. INL vs V_D

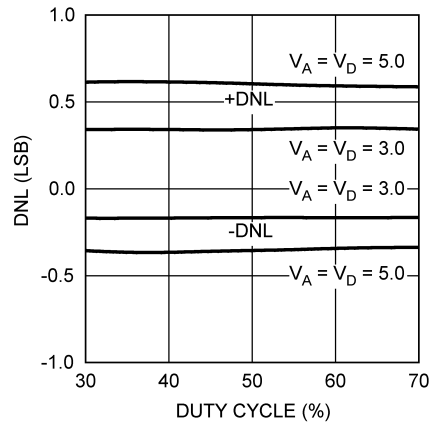

Figure 15. DNL vs SCLK Duty Cycle

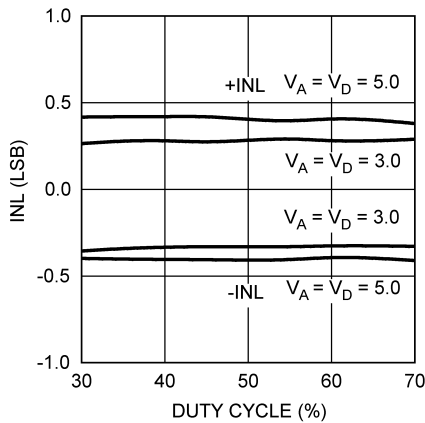

Figure 16. INL vs SCLK Duty Cycle

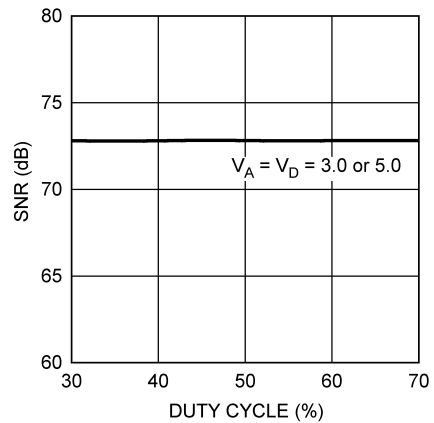

Figure 17. SNR vs SCLK Duty Cycle

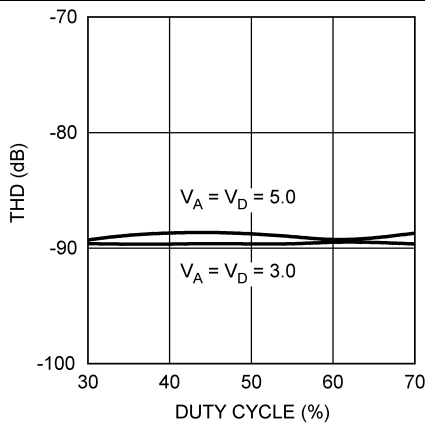

Figure 18. THD vs SCLK Duty Cycle

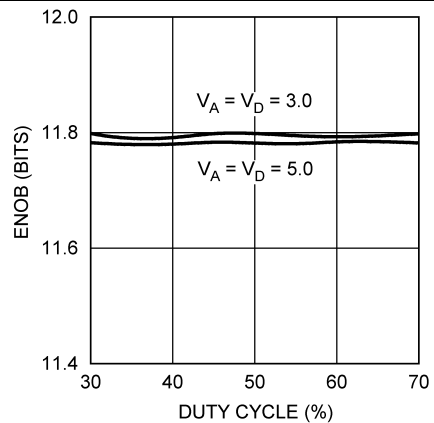
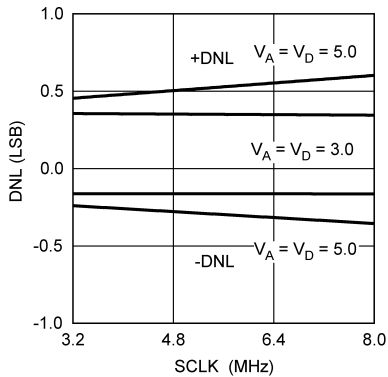
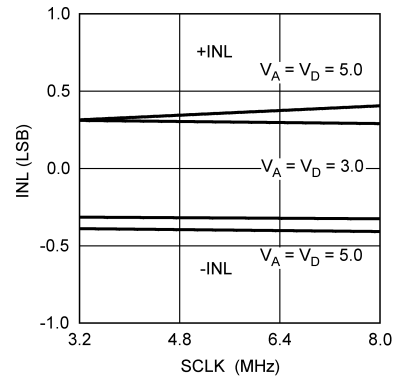
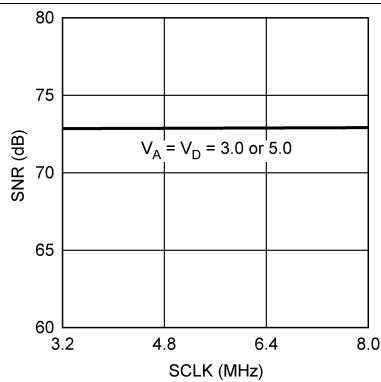
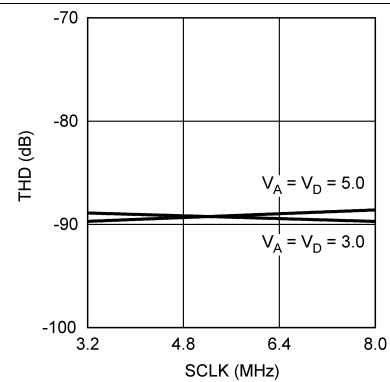
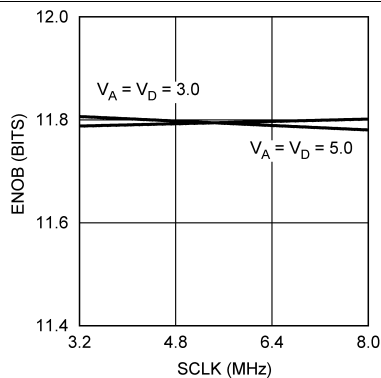
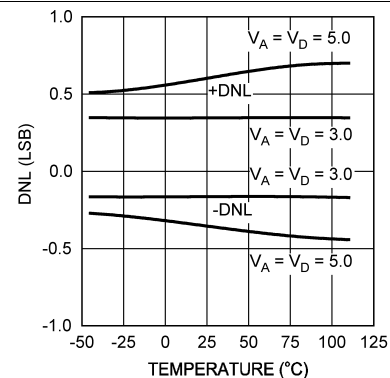

Figure 19. ENOB vs SCLK Duty Cycle

Typical Characteristics (continued)
 $T_A = 25^\circ\text{C}$, $f_{\text{SAMPLE}} = 500 \text{ kSPS}$, $f_{\text{SCLK}} = 8 \text{ MHz}$, $f_{\text{IN}} = 40.2 \text{ kHz}$ unless otherwise stated

Figure 20. DNL vs SCLK

Figure 21. INL vs SCLK

Figure 22. SNR vs SCLK

Figure 23. THD vs SCLK

Figure 24. ENOB vs SCLK

Figure 25. DNL vs Temperature

Typical Characteristics (continued)

$T_A = 25^\circ\text{C}$, $f_{\text{SAMPLE}} = 500 \text{ kSPS}$, $f_{\text{SCLK}} = 8 \text{ MHz}$, $f_{\text{IN}} = 40.2 \text{ kHz}$ unless otherwise stated

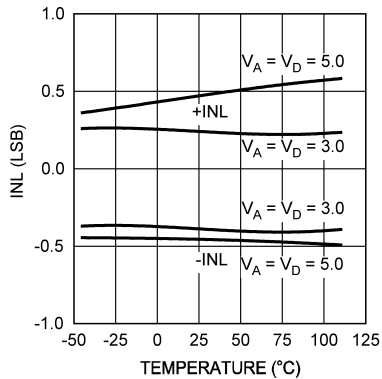

Figure 26. INL vs Temperature

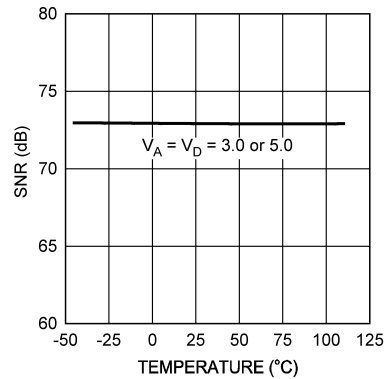

Figure 27. SNR vs Temperature

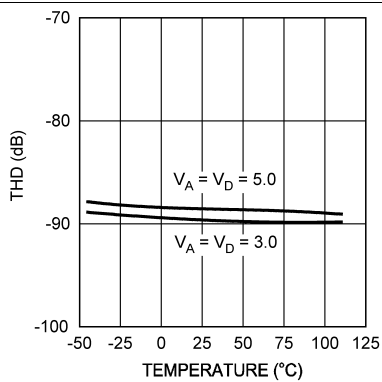

Figure 28. THD vs Temperature

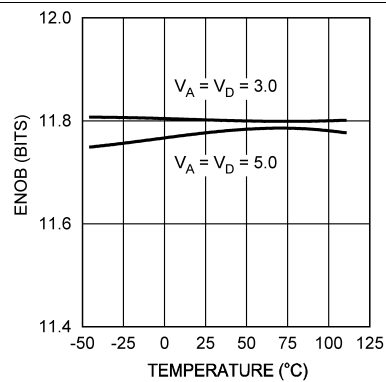

Figure 29. ENOB vs Temperature

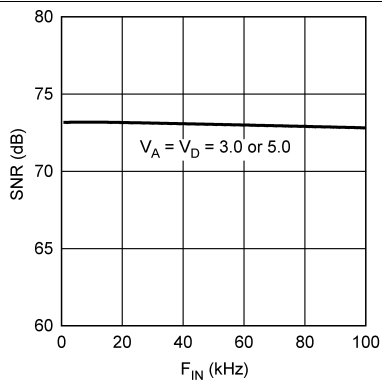

Figure 30. SNR vs Input Frequency

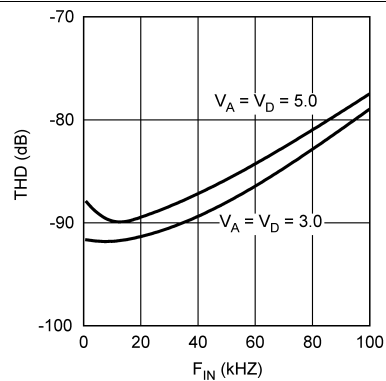

Figure 31. THD vs Input Frequency

Typical Characteristics (continued)

$T_A = 25^\circ\text{C}$, $f_{\text{SAMPLE}} = 500 \text{ kSPS}$, $f_{\text{SCLK}} = 8 \text{ MHz}$, $f_{\text{IN}} = 40.2 \text{ kHz}$ unless otherwise stated

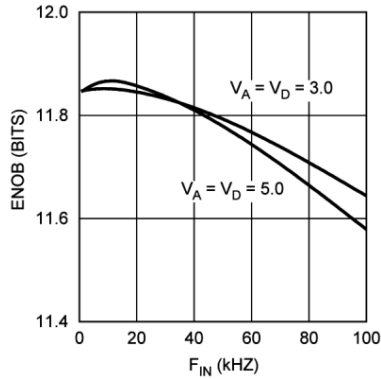

Figure 32. ENOB vs Input Frequency

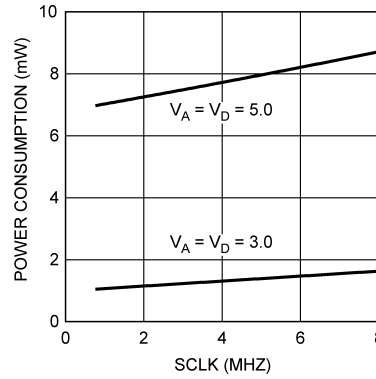

Figure 33. Power Consumption vs SCLK

7 Detailed Description

7.1 Overview

The ADC128S052x is a successive-approximation analog-to-digital converter designed around a charge-redistribution digital-to-analog converter. For the remainder of this document, ADC128S052x is abbreviated to ADC128S052.

7.2 Functional Block Diagram

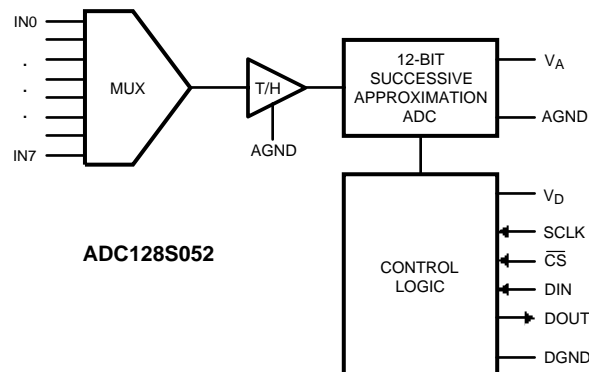

7.3 Feature Description

7.3.1 Operation

Simplified schematics of the ADC128S052 in both track and hold operation are shown in [Figure 34](#) and [Figure 35](#), respectively. In [Figure 34](#), the ADC128S052 is in track mode: switch SW1 connects the sampling capacitor to one of eight analog input channels through the multiplexer, and SW2 balances the comparator inputs. The ADC128S052 is in this state for the first three SCLK cycles after CS is brought low.

[Figure 35](#) shows the ADC128S052 in hold mode: switch SW1 connects the sampling capacitor to ground, maintaining the sampled voltage, and switch SW2 unbalances the comparator. The control logic then instructs the charge-redistribution DAC to add or subtract fixed amounts of charge to or from the sampling capacitor until the comparator is balanced. When the comparator is balanced, the digital word supplied to the DAC is the digital representation of the analog input voltage. The ADC128S052 is in this state for the last thirteen SCLK cycles after CS is brought low.

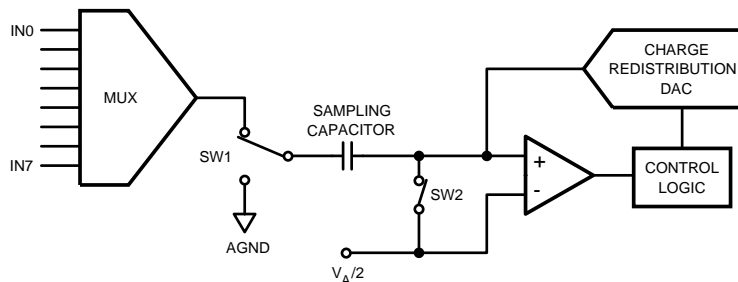

Figure 34. ADC128S052 in Track Mode

Feature Description (continued)

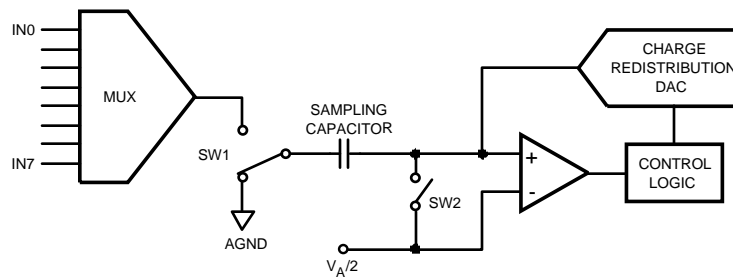

Figure 35. ADC128S052 in Hold Mode

7.3.2 Transfer Function

The output format of the ADC128S052 is straight binary. Code transitions occur midway between successive integer LSB values. The LSB width for the ADC128S052 is $V_A / 4096$. The ideal transfer characteristic is shown in Figure 36. The transition from an output code of 0000 0000 0000 to a code of 0000 0000 0001 is at $1/2$ LSB, or a voltage of $V_A / 8192$. Other code transitions occur at steps of one LSB.

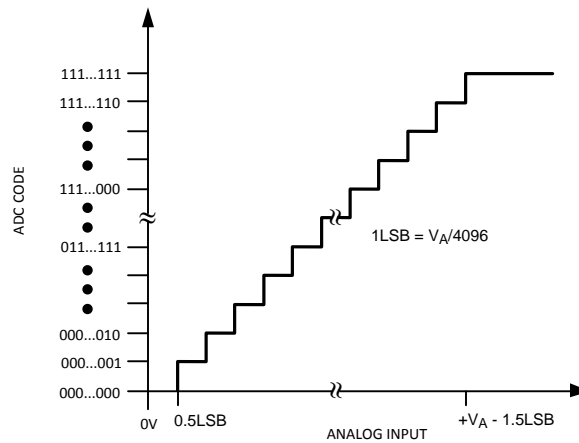

Figure 36. Ideal Transfer Characteristic

7.4 Device Functional Modes

The ADC128S052 is fully powered up whenever \overline{CS} is low and fully powered down whenever \overline{CS} is high, with one exception. If operating in continuous conversion mode, the ADC128S052 automatically enters power-down mode between the SCLK 16th falling edge of a conversion and the SCLK 1st falling edge of the subsequent conversion (see Figure 1).

In continuous conversion mode, the ADC128S052 can perform multiple conversions back-to-back. Each conversion requires 16 SCLK cycles, and the ADC128S052 performs conversions continuously as long as \overline{CS} is held low. Continuous mode offers maximum throughput.

Device Functional Modes (continued)

In burst mode, the user may trade off throughput for power consumption by performing fewer conversions per unit time. This means spending more time in power-down mode and less time in normal mode. By utilizing this technique, the user can achieve very low sample rates while still utilizing an SCLK frequency within the electrical specifications. [Figure 33](#) in the *Typical Characteristics* section shows the typical power consumption of the ADC128S052. To calculate the power consumption (P_C), simply multiply the fraction of time spent in the normal mode (t_N) by the normal mode power consumption (P_N), and add the fraction of time spent in shutdown mode (t_S) multiplied by the shutdown mode power consumption (P_S) as shown in [Equation 1](#).

$$P_C = \frac{t_N}{t_N + t_S} \times P_N + \frac{t_S}{t_N + t_S} \times P_S \quad (1)$$

7.5 Programming

7.5.1 Serial Interface

[Figure 1](#) shows a operational timing diagram, and [Figure 2](#) shows a serial interface timing diagram for the ADC128S052. \overline{CS} (chip select) initiates conversions and frames the serial data transfers. SCLK (serial clock) controls both the conversion process and the timing of serial data. DOUT is the serial data output pin, where a conversion result is sent as a serial data stream, MSB first. Data to be written to the control register of the device is placed on DIN, the serial data input pin. New data is written to DIN with each conversion.

A serial frame is initiated on the falling edge of \overline{CS} and ends on the rising edge of \overline{CS} . Each frame must contain an integer multiple of 16 rising SCLK edges. The ADC's DOUT pin is in a high impedance state when \overline{CS} is high and is active when \overline{CS} is low. Thus, \overline{CS} acts as an output enable. Similarly, SCLK is internally gated off when \overline{CS} is brought high.

During the first 3 cycles of SCLK, the ADC is in the track mode, acquiring the input voltage. For the next 13 SCLK cycles the conversion is accomplished, and the data is clocked out. SCLK falling edges 1 through 4 clock out leading zeros while falling edges 5 through 16 clock out the conversion result, MSB first. If there is more than one conversion in a frame (continuous conversion mode), the ADC re-enters the track mode on the falling edge of SCLK after the $N \times 16$ th rising edge of SCLK and re-enter the hold/convert mode on the $N \times 16 + 4$ th falling edge of SCLK. N is an integer value.

The ADC128S052 enters track mode under three different conditions. In [Figure 1](#), \overline{CS} goes low with SCLK high, and the ADC enters track mode on the first falling edge of SCLK. In the second condition, \overline{CS} goes low with SCLK low. Under this condition, the ADC automatically enters track mode and the falling edge of \overline{CS} is seen as the first falling edge of SCLK. In the third condition, \overline{CS} and SCLK go low simultaneously, and the ADC enters track mode. While there is no timing restriction with respect to the rising edges of \overline{CS} and SCLK, see [Figure 3](#) for setup and hold time requirements for the falling edge of \overline{CS} with respect to the rising edge of SCLK.

While a conversion is in progress, the address of the next input for conversion is clocked into a control register through the DIN pin on the first 8 rising edges of SCLK after the fall of \overline{CS} . See [Table 1](#), [Table 2](#), [Table 3](#).

There is no need to incorporate a power-up delay or dummy conversion as the ADC128S052 is able to acquire the input signal to full resolution in the first conversion immediately following power up. The first conversion result after power-up is that of IN0.

7.6 Register Maps

Table 1. Control Register Bits

7	6	5	4	3	2	1	0
DONTC	DONTC	ADD2	ADD1	ADD0	DONTC	DONTC	DONTC

Table 2. Control Register Bit Descriptions

BIT NO.	SYMBOL	DESCRIPTION
7, 6, 2, 1, 0	DONTC	Don't care. The values of these bits do not affect the device.
5	ADD2	These three bits determine which input channel is sampled and converted at the next conversion cycle. The mapping between codes and channels is shown in Table 3 .
4	ADD1	
3	ADD0	

Table 3. Input Channel Selection

ADD2	ADD1	ADD0	INPUT CHANNEL
0	0	0	IN0 (Default)
0	0	1	IN1
0	1	0	IN2
0	1	1	IN3
1	0	0	IN4
1	0	1	IN5
1	1	0	IN6
1	1	1	IN7

8 Application and Implementation

NOTE

Information in the following applications sections is not part of the TI component specification, and TI does not warrant its accuracy or completeness. TI's customers are responsible for determining suitability of components for their purposes. Customers should validate and test their design implementation to confirm system functionality.

8.1 Application Information

8.1.1 Analog Inputs

An equivalent circuit for one of the input channels of the ADC128S052 is shown in Figure 37. Diodes D1 and D2 provide ESD protection for the analog inputs. The operating range for the analog inputs is 0 V to V_A . Going beyond this range causes the ESD diodes to conduct and result in erratic operation.

The capacitor C1 in Figure 37 has a typical value of 3 pF and is mainly the package pin capacitance. Resistor R1 is the on resistance of the multiplexer and track or hold switch and is typically 500 Ω . Capacitor C2 is the ADC128S052 sampling capacitor and is typically 30 pF. The ADC128S052 delivers best performance when driven by a low-impedance source (less than 100 Ω). This is especially important when using the ADC128S052 to sample dynamic signals. Also important when sampling dynamic signals is a band-pass or low-pass filter which reduces harmonics and noise in the input. These filters are often referred to as anti-aliasing filters.

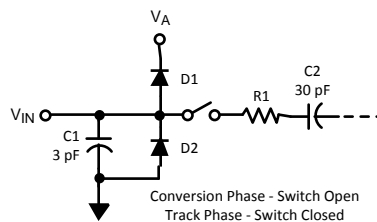

Figure 37. Equivalent Input Circuit

8.1.2 Digital Inputs and Outputs

The digital inputs (SCLK, \overline{CS} , and DIN) of the ADC128S052 have an operating range of 0 V to V_A . They are not prone to latch-up and may be asserted before the digital supply (V_D) without any risk. The digital output (DOUT) operating range is controlled by V_D . The output high voltage is $V_D - 0.5$ V (minimum) while the output low voltage is 0.4 V (maximum).

8.2 Typical Application

A typical application is shown in Figure 38. The analog supply is bypassed with a capacitor network located close to the ADC128S052. The ADC128S052 uses the analog supply (V_A) as its reference voltage, so it is very important that V_A be kept as clean as possible. Due to the low power requirements of the ADC128S052, it is also possible to use a precision reference as a power supply.

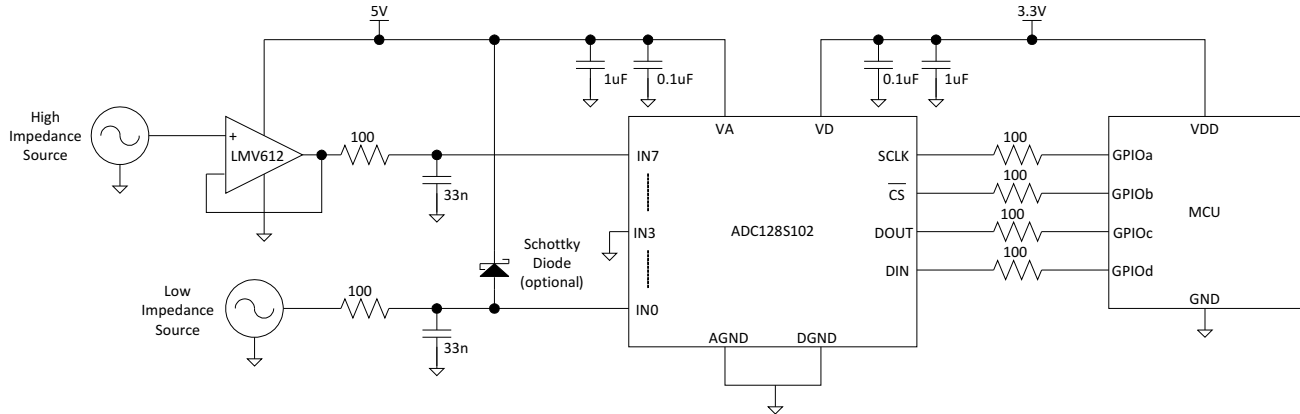

Figure 38. Typical Application Circuit

8.2.1 Design Requirements

A positive supply-only data acquisition system capable of digitizing signals ranging 0 to 5 V, BW = 10 kHz, and a throughput of 125 kSPS.

The ADC128S052 has to interface to a microcontroller with the supply is set at 3.3 V.

8.2.2 Detailed Design Procedure

The signal range requirement forces the design to use 5-V analog supply at V_A , analog supply. This follows from the fact that V_A is also a reference potential for the ADC.

The requirement of interfacing to the microcontroller which is powered by a 3.3-V supply, forces the choice of 3.3 V as a V_D supply.

Sampling is in fact a modulation process which may result in aliasing of the input signal, if the input signal is not adequately band limited. The maximum sampling rate of the ADC128S052 when all channels are enabled is, F_s is calculated by Equation 2:

$$F_s = \frac{F_{SCLK}}{16 \times 8} \quad (2)$$

Note that faster sampling rates can be achieved when fewer channels are sampled. Single channel can be sampled at the maximum rate of:

$$F_{s_single} = \frac{F_{SCLK}}{16} \quad (3)$$

In order to avoid the aliasing the Nyquist criterion has to be met:

$$BW_{signal} < \frac{F_s}{2} \quad (4)$$

Therefore it is necessary to place anti-aliasing filters at all inputs of the ADC. These filters may be single-pole low-pass filters. The pole locations need to satisfy, assuming all channels sampled in sequence, Equation 5 and Equation 6:

$$\frac{1}{\pi \times R \times C} < \frac{F_{SCLK}}{16 \times 8} \quad (5)$$

$$R \times C > \frac{128}{\pi \times F_{SCLK}} \quad (6)$$

Typical Application (continued)

With $F_{SCLK} = 16$ MHz, a good choice for the single pole filter is:

- $R = 100$
- $C = 33$ nF

This reduces the input $BW_{signal} = 48$ kHz. The capacitor at the INx input of the device provides not only the filtering of the input signal, but it also absorbs the charge kick-back from the ADC. The kick-back is the result of the internal switches opening at the end of the acquisition period.

The V_A and V_D sources are already separated in this example, due to the design requirements. This also benefits the overall performance of the ADC, as the potentially noisy V_D supply does not contaminate the V_A . In the same vein, further consideration could be given to the SPI interface, especially when the master microcontroller is capable of producing fast rising edges on the digital bus signals. Inserting small resistances in the digital signal path may help in reducing the ground bounce, and thus improve the overall noise performance of the system.

Take care when the signal source is capable of producing voltages beyond V_A . In such instances the internal ESD diodes may start conducting. The ESD diodes are not intended as input signal clamps. To provide the desired clamping action use Schottky diodes as shown in [Figure 38](#).

8.2.3 Application Curve

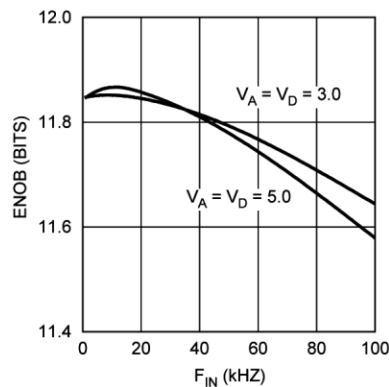

Figure 39. Typical Performance

9 Power Supply Recommendations

There are three major power supply concerns with this product: power supply sequencing, power management, and the effect of digital supply noise on the analog supply.

9.1 Power Supply Sequence

The ADC128S052 is a dual-supply device. The two supply pins share ESD resources, so exercise care to ensure that the power is applied in the correct sequence. To avoid turning on the ESD diodes, the digital supply (V_D) cannot exceed the analog supply (V_A) by more than 300 mV, not even on a transient basis. Therefore, V_A must ramp up before or concurrently with V_D .

9.2 Power Supply Noise Considerations

The charging of any output load capacitance requires current from the digital supply, V_D . The current pulses required from the supply to charge the output capacitance causes voltage variations on the digital supply. If these variations are large enough, they could degrade SNR and SINAD performance of the ADC. Furthermore, if the analog and digital supplies are tied directly together, the noise on the digital supply is coupled directly into the analog supply, causing greater performance degradation than would noise on the digital supply alone. Similarly, discharging the output capacitance when the digital output goes from a logic high to a logic low dumps current into the die substrate, which is resistive. Load discharge currents causes *ground bounce* noise in the substrate that degrades noise performance if that current is large enough. The larger the output capacitance, the more current flows through the die substrate and the greater the noise coupled into the analog channel.

The first solution for keeping digital noise out of the analog supply is to decouple the analog and digital supplies from each other or use separate supplies for them. To keep noise out of the digital supply, keep the output load capacitance as small as practical. If the load capacitance is greater than 50 pF, use a 100- Ω series resistor at the ADC output, located as close to the ADC output pin as practical. This limits the charge and discharge current of the output capacitance and improves noise performance. Because the series resistor and the load capacitor form a low frequency pole, verify signal integrity once the series resistor has been added.

10 Layout

10.1 Layout Guidelines

Capacitive coupling between the noisy digital circuitry and the sensitive analog circuitry can lead to poor performance. The solution is to keep the analog circuitry separated from the digital circuitry and the clock line as short as possible.

Digital circuits create substantial supply and ground current transients. The logic noise generated could have significant impact upon system noise performance. To avoid performance degradation of the ADC128S052 due to supply noise, do not use the same supply for the ADC128S052 that is used for digital logic.

Generally, analog and digital lines must cross each other at 90° to avoid crosstalk. However, to maximize accuracy in high resolution systems, avoid crossing analog and digital lines altogether. It is important to keep clock lines as short as possible and isolated from ALL other lines, including other digital lines. In addition, the clock line must also be treated as a transmission line and be properly terminated.

The analog input must be isolated from noisy signal traces to avoid coupling of spurious signals into the input. Any external component (for example, a filter capacitor) connected between the input pins and ground of the converter or to the reference input pin and ground must be connected to a very clean point in the ground plane.

TI recommends the use of a single, uniform ground plane and the use of split power planes. The power planes must be located within the same board layer. All analog circuitry (input amplifiers, filters, reference components, and so forth) must be placed over the analog power plane. All digital circuitry and I/O lines must be placed over the digital power plane. Furthermore, all components in the reference circuitry and the input signal chain that are connected to ground must be connected together with short traces and enter the analog ground plane at a single, quiet point.

10.2 Layout Example

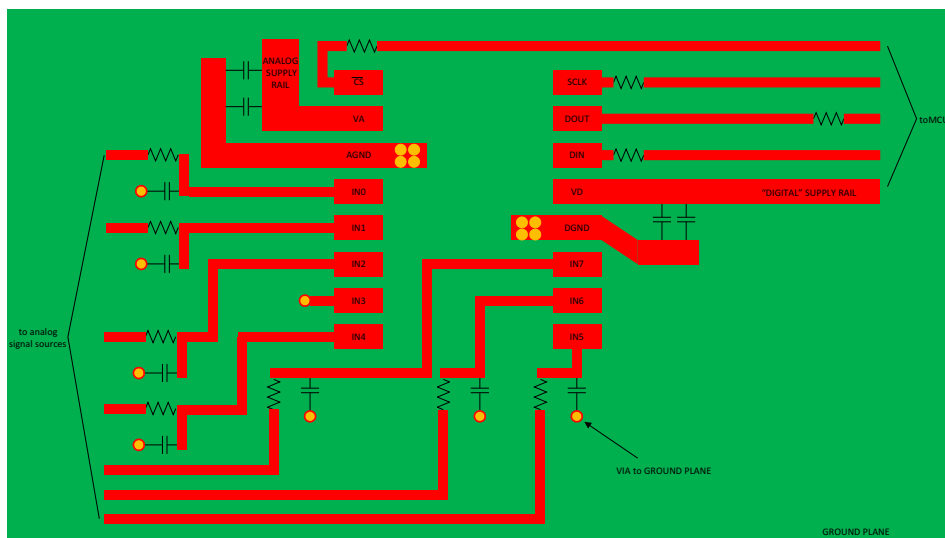

Figure 40. Layout Schematic

11 Device and Documentation Support

11.1 Device Support

11.1.1 Device Nomenclature

11.1.1.1 Specification Definitions

ACQUISITION TIME is the time required for the ADC to acquire the input voltage. During this time, the hold capacitor is charged by the input voltage.

APERTURE DELAY is the time between the fourth falling edge of SCLK and the time when the input signal is internally acquired or held for conversion.

CONVERSION TIME is the time required, after the input voltage is acquired, for the ADC to convert the input voltage to a digital word.

CHANNEL-TO-CHANNEL ISOLATION is resistance to coupling of energy from one channel into another channel.

CROSSTALK is the coupling of energy from one channel into another channel. This is similar to Channel-to-Channel Isolation, except for the sign of the data.

DIFFERENTIAL NON-LINEARITY (DNL) is the measure of the maximum deviation from the ideal step size of 1 LSB.

DUTY CYCLE is the ratio of the time that a repetitive digital waveform is high to the total time of one period. The specification here refers to the SCLK.

EFFECTIVE NUMBER OF BITS (ENOB, or EFFECTIVE BITS) is another method of specifying Signal-to-Noise and Distortion or SINAD. ENOB is defined as $(\text{SINAD} - 1.76) / 6.02$ and says that the converter is equivalent to a perfect ADC of this (ENOB) number of bits.

FULL POWER BANDWIDTH is a measure of the frequency at which the reconstructed output fundamental drops 3 dB below its low frequency value for a full scale input.

FULL SCALE ERROR (FSE) is a measure of how far the last code transition is from the ideal $1\frac{1}{2}$ LSB below V_{REF}^+ and is defined as:

$$V_{\text{FSE}} = V_{\text{max}} + 1.5 \text{ LSB} - V_{\text{REF}}^+$$

- where V_{max} is the voltage at which the transition to the maximum code occurs. FSE can be expressed in Volts, LSB or percent of full scale range. (7)

GAIN ERROR is the deviation of the last code transition (111...110) to (111...111) from the ideal ($V_{\text{REF}} - 1.5 \text{ LSB}$), after adjusting for offset error.

INTEGRAL NON-LINEARITY (INL) is a measure of the deviation of each individual code from a line drawn from negative full scale ($\frac{1}{2}$ LSB below the first code transition) through positive full scale ($\frac{1}{2}$ LSB above the last code transition). The deviation of any given code from this straight line is measured from the center of that code value.

INTERMODULATION DISTORTION (IMD) is the creation of additional spectral components as a result of two sinusoidal frequencies being applied to an individual ADC input at the same time. It is defined as the ratio of the power in both the second or the third order intermodulation products to the power in one of the original frequencies. Second order products are $f_a \pm f_b$, where f_a and f_b are the two sine wave input frequencies. Third order products are $(2f_a \pm f_b)$ and $(f_a \pm 2f_b)$. IMD is usually expressed in dB.

MISSING CODES are those output codes that never appear at the ADC outputs. These codes cannot be reached with any input value. The ADC128S052 is ensured not to have any missing codes.

OFFSET ERROR is the deviation of the first code transition (000...000) to (000...001) from the ideal (that is, GND + 0.5 LSB).

SIGNAL-TO-NOISE RATIO (SNR) is the ratio, expressed in dB, of the rms value of the input signal to the rms value of the sum of all other spectral components below one-half the sampling frequency, not including d.c. or the harmonics included in THD.

Device Support (continued)

SIGNAL-TO-NOISE PLUS DISTORTION (S/N+D or SINAD) is the ratio, expressed in dB, of the rms value of the input signal to the rms value of all of the other spectral components below half the clock frequency, including harmonics but excluding d.c.

SPURIOUS FREE DYNAMIC RANGE (SFDR) is the difference, expressed in dB, between the desired signal amplitude to the amplitude of the peak spurious spectral component, where a spurious spectral component is any signal present in the output spectrum that is not present at the input and may or may not be a harmonic.

TOTAL HARMONIC DISTORTION (THD) is the ratio, expressed in dBc, of the rms total of the first five harmonic components at the output to the rms level of the input signal frequency as seen at the output. THD is calculated as

$$\text{THD} = 20 \cdot \log_{10} \sqrt{\frac{A_{f2}^2 + \dots + A_{f10}^2}{A_{f1}^2}}$$

- where A_{f1} is the RMS power of the input frequency at the output and A_{f2} through A_{f6} are the RMS power in the first 5 harmonic frequencies. (8)

THROUGHPUT TIME is the minimum time required between the start of two successive conversions. It is the acquisition time plus the conversion and read out times. In the case of the ADC128S052, this is 16 SCLK periods.

11.2 Related Links

The table below lists quick access links. Categories include technical documents, support and community resources, tools and software, and quick access to sample or buy.

Table 4. Related Links

PARTS	PRODUCT FOLDER	SAMPLE & BUY	TECHNICAL DOCUMENTS	TOOLS & SOFTWARE	SUPPORT & COMMUNITY
ADC128S052	Click here	Click here	Click here	Click here	Click here
ADC128S052-Q1	Click here	Click here	Click here	Click here	Click here

11.3 Community Resources

The following links connect to TI community resources. Linked contents are provided "AS IS" by the respective contributors. They do not constitute TI specifications and do not necessarily reflect TI's views; see TI's [Terms of Use](#).

TI E2E™ Online Community *TI's Engineer-to-Engineer (E2E) Community*. Created to foster collaboration among engineers. At e2e.ti.com, you can ask questions, share knowledge, explore ideas and help solve problems with fellow engineers.

Design Support *TI's Design Support* Quickly find helpful E2E forums along with design support tools and contact information for technical support.

11.4 Trademarks

E2E is a trademark of Texas Instruments.

SPI, QSPI are trademarks of Motorola.

All other trademarks are the property of their respective owners.

11.5 Electrostatic Discharge Caution



These devices have limited built-in ESD protection. The leads should be shorted together or the device placed in conductive foam during storage or handling to prevent electrostatic damage to the MOS gates.

11.6 Glossary





[SLYZ022](#) — *TI Glossary*.

This glossary lists and explains terms, acronyms, and definitions.

12 Mechanical, Packaging, and Orderable Information

The following pages include mechanical, packaging, and orderable information. This information is the most current data available for the designated devices. This data is subject to change without notice and revision of this document. For browser-based versions of this data sheet, refer to the left-hand navigation.

PACKAGING INFORMATION

Orderable Device	Status (1)	Package Type	Package Drawing	Pins	Package Qty	Eco Plan (2)	Lead finish/ Ball material (6)	MSL Peak Temp (3)	Op Temp (°C)	Device Marking (4/5)	Samples
ADC128S052CIMT/NOPB	ACTIVE	TSSOP	PW	16	92	RoHS & Green	SN	Level-1-260C-UNLIM	-40 to 125	128S052 CIMT	
ADC128S052CIMTX/NOPB	ACTIVE	TSSOP	PW	16	2500	RoHS & Green	SN	Level-1-260C-UNLIM	-40 to 125	128S052 CIMT	
ADC128S052QCMT/NOPB	ACTIVE	TSSOP	PW	16	92	RoHS & Green	SN	Level-1-260C-UNLIM	-40 to 125	128S052 QCMT	
ADC128S052QCMTX/NOPB	ACTIVE	TSSOP	PW	16	2500	RoHS & Green	SN	Level-1-260C-UNLIM	-40 to 125	128S052 QCMT	

(1) The marketing status values are defined as follows:

ACTIVE: Product device recommended for new designs.

LIFEBUY: TI has announced that the device will be discontinued, and a lifetime-buy period is in effect.

NRND: Not recommended for new designs. Device is in production to support existing customers, but TI does not recommend using this part in a new design.

PREVIEW: Device has been announced but is not in production. Samples may or may not be available.

OBSELETE: TI has discontinued the production of the device.

(2) **RoHS:** TI defines "RoHS" to mean semiconductor products that are compliant with the current EU RoHS requirements for all 10 RoHS substances, including the requirement that RoHS substance do not exceed 0.1% by weight in homogeneous materials. Where designed to be soldered at high temperatures, "RoHS" products are suitable for use in specified lead-free processes. TI may reference these types of products as "Pb-Free".

RoHS Exempt: TI defines "RoHS Exempt" to mean products that contain lead but are compliant with EU RoHS pursuant to a specific EU RoHS exemption.

Green: TI defines "Green" to mean the content of Chlorine (Cl) and Bromine (Br) based flame retardants meet JS709B low halogen requirements of <=1000ppm threshold. Antimony trioxide based flame retardants must also meet the <=1000ppm threshold requirement.

(3) MSL, Peak Temp. - The Moisture Sensitivity Level rating according to the JEDEC industry standard classifications, and peak solder temperature.

(4) There may be additional marking, which relates to the logo, the lot trace code information, or the environmental category on the device.

(5) Multiple Device Markings will be inside parentheses. Only one Device Marking contained in parentheses and separated by a "~" will appear on a device. If a line is indented then it is a continuation of the previous line and the two combined represent the entire Device Marking for that device.

(6) Lead finish/Ball material - Orderable Devices may have multiple material finish options. Finish options are separated by a vertical ruled line. Lead finish/Ball material values may wrap to two lines if the finish value exceeds the maximum column width.

Important Information and Disclaimer:The information provided on this page represents TI's knowledge and belief as of the date that it is provided. TI bases its knowledge and belief on information provided by third parties, and makes no representation or warranty as to the accuracy of such information. Efforts are underway to better integrate information from third parties. TI has taken and

continues to take reasonable steps to provide representative and accurate information but may not have conducted destructive testing or chemical analysis on incoming materials and chemicals. TI and TI suppliers consider certain information to be proprietary, and thus CAS numbers and other limited information may not be available for release.

In no event shall TI's liability arising out of such information exceed the total purchase price of the TI part(s) at issue in this document sold by TI to Customer on an annual basis.

OTHER QUALIFIED VERSIONS OF ADC128S052, ADC128S052-Q1 :

- Catalog: [ADC128S052](#)
- Automotive: [ADC128S052-Q1](#)

NOTE: Qualified Version Definitions:

- Catalog - TI's standard catalog product
- Automotive - Q100 devices qualified for high-reliability automotive applications targeting zero defects

TAPE AND REEL INFORMATION

QUADRANT ASSIGNMENTS FOR PIN 1 ORIENTATION IN TAPE



*All dimensions are nominal

Device	Package Type	Package Drawing	Pins	SPQ	Reel Diameter (mm)	Reel Width W1 (mm)	A0 (mm)	B0 (mm)	K0 (mm)	P1 (mm)	W (mm)	Pin1 Quadrant
ADC128S052CIMTX/ NOPB	TSSOP	PW	16	2500	330.0	12.4	6.95	5.6	1.6	8.0	12.0	Q1
ADC128S052QCMTX/ NOPB	TSSOP	PW	16	2500	330.0	12.4	6.95	5.6	1.6	8.0	12.0	Q1

TAPE AND REEL BOX DIMENSIONS

*All dimensions are nominal

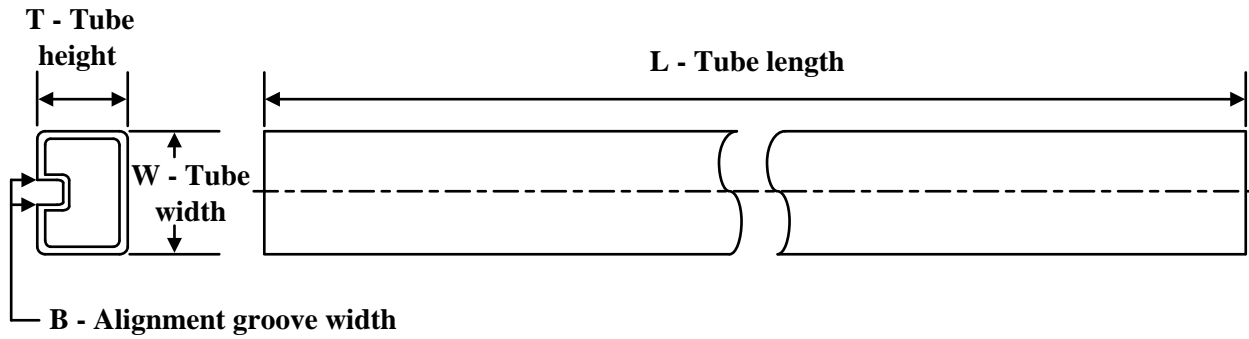
Device	Package Type	Package Drawing	Pins	SPQ	Length (mm)	Width (mm)	Height (mm)
ADC128S052CIMTX/ NOPB	TSSOP	PW	16	2500	367.0	367.0	35.0
ADC128S052QCMTX/ NOPB	TSSOP	PW	16	2500	367.0	367.0	35.0

TUBE

*All dimensions are nominal

Device	Package Name	Package Type	Pins	SPQ	L (mm)	W (mm)	T (μm)	B (mm)
ADC128S052CIMT/NOPB	PW	TSSOP	16	92	495	8	2514.6	4.06
ADC128S052QCMT/NOPB	PW	TSSOP	16	92	495	8	2514.6	4.06



4220204/A 02/2017

NOTES:

1. All linear dimensions are in millimeters. Any dimensions in parenthesis are for reference only. Dimensioning and tolerancing per ASME Y14.5M.
2. This drawing is subject to change without notice.
3. This dimension does not include mold flash, protrusions, or gate burrs. Mold flash, protrusions, or gate burrs shall not exceed 0.15 mm per side.
4. This dimension does not include interlead flash. Interlead flash shall not exceed 0.25 mm per side.
5. Reference JEDEC registration MO-153.

EXAMPLE BOARD LAYOUT

PW0016A

TSSOP - 1.2 mm max height

SMALL OUTLINE PACKAGE



LAND PATTERN EXAMPLE
EXPOSED METAL SHOWN
SCALE: 10X



SOLDER MASK DETAILS

4220204/A 02/2017

NOTES: (continued)

- 6. Publication IPC-7351 may have alternate designs.
- 7. Solder mask tolerances between and around signal pads can vary based on board fabrication site.

EXAMPLE STENCIL DESIGN

PW0016A

TSSOP - 1.2 mm max height

SMALL OUTLINE PACKAGE



SOLDER PASTE EXAMPLE
BASED ON 0.125 mm THICK STENCIL
SCALE: 10X

4220204/A 02/2017

NOTES: (continued)

8. Laser cutting apertures with trapezoidal walls and rounded corners may offer better paste release. IPC-7525 may have alternate design recommendations.
9. Board assembly site may have different recommendations for stencil design.

IMPORTANT NOTICE AND DISCLAIMER

TI PROVIDES TECHNICAL AND RELIABILITY DATA (INCLUDING DATA SHEETS), DESIGN RESOURCES (INCLUDING REFERENCE DESIGNS), APPLICATION OR OTHER DESIGN ADVICE, WEB TOOLS, SAFETY INFORMATION, AND OTHER RESOURCES "AS IS" AND WITH ALL FAULTS, AND DISCLAIMS ALL WARRANTIES, EXPRESS AND IMPLIED, INCLUDING WITHOUT LIMITATION ANY IMPLIED WARRANTIES OF MERCHANTABILITY, FITNESS FOR A PARTICULAR PURPOSE OR NON-INFRINGEMENT OF THIRD PARTY INTELLECTUAL PROPERTY RIGHTS.

These resources are intended for skilled developers designing with TI products. You are solely responsible for (1) selecting the appropriate TI products for your application, (2) designing, validating and testing your application, and (3) ensuring your application meets applicable standards, and any other safety, security, regulatory or other requirements.

These resources are subject to change without notice. TI grants you permission to use these resources only for development of an application that uses the TI products described in the resource. Other reproduction and display of these resources is prohibited. No license is granted to any other TI intellectual property right or to any third party intellectual property right. TI disclaims responsibility for, and you will fully indemnify TI and its representatives against, any claims, damages, costs, losses, and liabilities arising out of your use of these resources.

TI's products are provided subject to [TI's Terms of Sale](#) or other applicable terms available either on ti.com or provided in conjunction with such TI products. TI's provision of these resources does not expand or otherwise alter TI's applicable warranties or warranty disclaimers for TI products.

TI objects to and rejects any additional or different terms you may have proposed.

Mailing Address: Texas Instruments, Post Office Box 655303, Dallas, Texas 75265
Copyright © 2022, Texas Instruments Incorporated

X-ON Electronics

Largest Supplier of Electrical and Electronic Components

Click to view similar products for [Analog to Digital Converters - ADC category](#):

Click to view products by [Texas Instruments manufacturer](#):

Other Similar products are found below :

[MCP37211-200I/TE](#) [AD9235BCPZRL7-40](#) [HT7316ARQZ](#) [ADS1100A3IDBVR](#) [HI1175JCB](#) [HI3-574AJN-5](#) [HI5714/4CB](#) [HI5746KCA](#)
[HI5766KCAZ](#) [HI5766KCBZ](#) [ISOSD61TR](#) [ES7201](#) [AD7266BSUZ-REEL](#) [AD7708BRZ-REEL7](#) [CLM2543IDW](#) [CLM2543CDW](#)
[MCP3004T-I/SL](#) [ADS7853IPWR](#) [GP9301BXI-F10K-D1V10-SH](#) [GP9301BXI-F10K-N-SH](#) [GP9101-F50-C1H1-SW](#) [GP9301BXI-F5K-N-SW](#)
[GP9101-F10K-N-SW](#) [GP9301BXI-F4K-D1V10-SH](#) [GP9301BXI-F1K-L5H2-SH](#) [LTC2484IDD#TRPBF](#) [AD9245BCPZRL7-20](#) [SSP1120](#)
[ADS8332IBRGER](#) [ADS8168IRHBR](#) [HT7705ARWZ](#) [ADS9224RIRHBR](#) [ADC101S051CIMF](#) [AD7779ACPZ-RL](#) [AD7714YRUZ-REEL](#)
[LTC2447IUHF#PBF](#) [AD9235BRUZRL7-20](#) [AD7888ARUZ-REEL](#) [AD7606BBSTZ-RL](#) [AD7998BRUZ-1REEL](#) [AD7276ARMZ-REEL](#)
[AD7712ARZ-REEL](#) [AD7997BRUZ-1REEL](#) [LTC2348ILX-16#PBF](#) [AD2S1210BSTZ-RL7](#) [AD7711ARZ-REEL7](#) [AD7865ASZ-1REEL](#)
[AD7923BRUZ-REEL](#) [AD7495ARZ-REEL7](#) [AD9629BCPZRL7-40](#)