

DRV5055-Q1 汽车比例式线性霍尔效应传感器

1 特性

- 比例式线性霍尔效应磁传感器
- 由 3.3V 和 5V 电源供电
- 模拟输出，提供 $V_{CC}/2$ 静态失调电压
- 磁性灵敏度选项 ($V_{CC} = 5V$ 时)：
 - A1: 100mV/mT, $\pm 21mT$ 范围
 - A2: 50mV/mT, $\pm 42mT$ 范围
 - A3: 25mV/mT, $\pm 85mT$ 范围
 - A4: 12.5mV/mT, $\pm 169mT$ 范围
 - A5: $-100mV/mT$, $\pm 21mT$ 范围
- 高速 20kHz 传感带宽
- 低噪声输出，具有 $\pm 1mA$ 驱动器
- 磁体温漂补偿
- 符合面向汽车应用的 AEC-Q100 标准：
 - 温度等级 0 级: $-40^{\circ}C$ 至 $150^{\circ}C$
- 标准行业封装：
 - 表面贴装 SOT-23
 - 穿孔 TO-92

2 应用

- 汽车位置检测
- 制动、加速、离合踏板
- 扭矩传感器、变速杆
- 节气门位置、高度找平
- 动力传动系统和变速系统组件
- 绝对值角度编码
- 电流检测

典型原理图

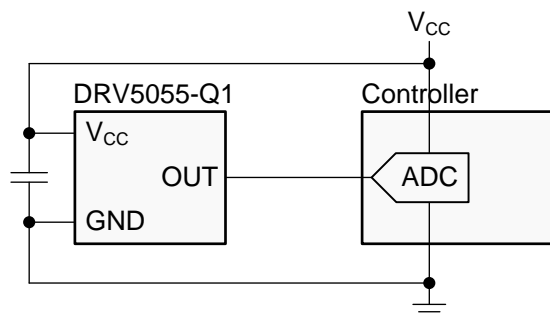

3 说明

DRV5055-Q1 是一款线性霍尔效应传感器，可按比例响应磁通量密度。该器件可用于进行精确的位置检测，应用范围广泛应用中的电源管理要求。

该器件由 3.3V 或 5V 电源供电。当不存在磁场时，模拟输出可驱动 $1/2 V_{CC}$ 。输出会随施加的磁通量密度呈线性变化，五个灵敏度选项可以根据所需的感应范围提供最大的输出电压摆幅。南北磁极产生唯一的电压。

它可检测垂直于封装顶部的磁通量，而且两个封装选项提供不同的检测方向。

该器件使用比例式架构，当外部模数转换器 (ADC) 使用相同的 V_{CC} 作为其基准电压时，可以消除 V_{CC} 容差产生的误差。此外，该器件还具有磁体温度补偿功能，可以抵消磁体漂移，在较宽的 $-40^{\circ}C$ 至 $+150^{\circ}C$ 温度范围内实现线性性能。

器件信息⁽¹⁾

器件型号	封装	封装尺寸 (标称值)
DRV5055-Q1	SOT-23 (3)	2.92mm × 1.30mm
	TO-92 (3)	4.00mm × 3.15mm

(1) 要了解所有可用封装，请参阅数据表末尾的可订购产品附录。

磁响应 (A1、A2、A3、A4 版本)

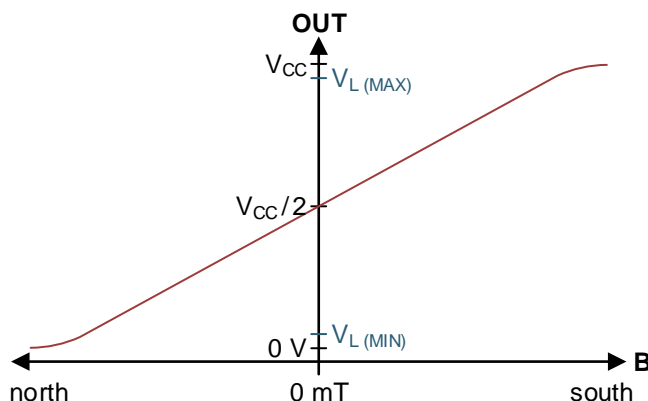

目录

1 特性 1 2 应用 1 3 说明 1 4 修订历史记录 2 5 Pin Configuration and Functions 3 6 Specifications 3 6.1 Absolute Maximum Ratings 3 6.2 ESD Ratings 4 6.3 Recommended Operating Conditions 4 6.4 Thermal Information 4 6.5 Electrical Characteristics 4 6.6 Magnetic Characteristics 5 6.7 Typical Characteristics 6 7 Detailed Description 9 7.1 Overview 9 7.2 Functional Block Diagram 9 7.3 Feature Description 9	7.4 Device Functional Modes 13 8 Application and Implementation 14 8.1 Application Information 14 8.2 Typical Application 15 8.3 Do's and Don'ts 17 9 Power Supply Recommendations 18 10 Layout 18 10.1 Layout Guidelines 18 10.2 Layout Examples 18 11 器件和文档支持 19 11.1 文档支持 19 11.2 接收文档更新通知 19 11.3 社区资源 19 11.4 商标 19 11.5 静电放电警告 19 11.6 术语表 19 12 机械、封装和可订购信息 19
--	--

4 修订历史记录

注：之前版本的页码可能与当前版本有所不同。

Changes from Revision B (January 2018) to Revision C	Page
• 已发布至生产	1

5 Pin Configuration and Functions

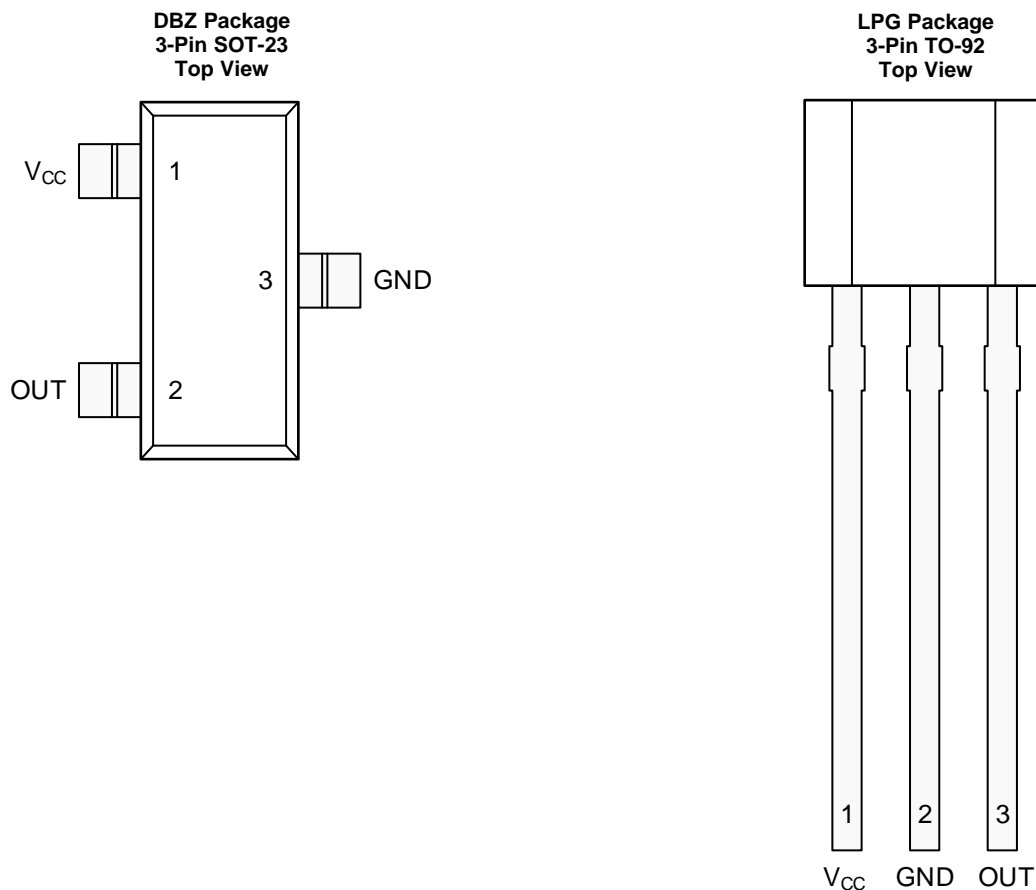

Pin Functions

NAME	PIN		I/O	DESCRIPTION
	SOT-23	TO-92		
V _{CC}	1	1	—	Power supply. TI recommends connecting this pin to a ceramic capacitor to ground with a value of at least 0.01 μ F.
OUT	2	3	O	Analog output
GND	3	2	—	Ground reference

6 Specifications

6.1 Absolute Maximum Ratings

over operating free-air temperature range (unless otherwise noted)⁽¹⁾

		MIN	MAX	UNIT
Power supply voltage	V _{CC}	-0.3	7	V
Output voltage	OUT	-0.3	V _{CC} + 0.3	V
Magnetic flux density, B _{MAX}		Unlimited		T
Operating junction temperature, T _J		-40	170	°C
Storage temperature, T _{stg}		-65	150	°C

(1) Stresses beyond those listed under *Absolute Maximum Ratings* may cause permanent damage to the device. These are stress ratings only, which do not imply functional operation of the device at these or any other conditions beyond those indicated under *Recommended Operating Conditions*. Exposure to absolute-maximum-rated conditions for extended periods may affect device reliability.

6.2 ESD Ratings

		VALUE	UNIT
V _(ESD)	Electrostatic discharge	Human body model (HBM), per AEC Q100-002 ⁽¹⁾	±2500
		Charged device model (CDM), per AEC Q100-011	±750

(1) AEC Q100-002 indicates that HBM stressing shall be in accordance with the ANSI/ESDA/JEDEC JS-001 specification.

6.3 Recommended Operating Conditions

over operating free-air temperature range (unless otherwise noted)

		MIN	MAX	UNIT
V _{CC}	Power-supply voltage ⁽¹⁾	3	3.63	V
		4.5	5.5	
I _O	Output continuous current	–1	1	mA
T _A	Operating ambient temperature ⁽²⁾	–40	150	°C

(1) There are two isolated operating V_{CC} ranges. For more information see the [Operating V_{CC} Ranges](#) section.

(2) Power dissipation and thermal limits must be observed.

6.4 Thermal Information

THERMAL METRIC ⁽¹⁾		DRV5055-Q1		UNIT
		SOT-23 (DBZ)	TO-92 (LPG)	
		3 PINS	3 PINS	
R _{θJA}	Junction-to-ambient thermal resistance	170	121	°C/W
R _{θJC(top)}	Junction-to-case (top) thermal resistance	66	67	°C/W
R _{θJB}	Junction-to-board thermal resistance	49	97	°C/W
Y _{JT}	Junction-to-top characterization parameter	1.7	7.6	°C/W
Y _{JB}	Junction-to-board characterization parameter	48	97	°C/W

(1) For more information about traditional and new thermal metrics, see the [Semiconductor and IC Package Thermal Metrics](#) application report.

6.5 Electrical Characteristics

for V_{CC} = 3 V to 3.63 V and 4.5 V to 5.5 V, over operating free-air temperature range (unless otherwise noted)

PARAMETER	TEST CONDITIONS ⁽¹⁾	MIN	TYP	MAX	UNIT
I _{CC}	Operating supply current		6	10	mA
t _{ON}	Power-on time (see Figure 18)	B = 0 mT, no load on OUT	175	330	μs
f _{BW}	Sensing bandwidth		20		kHz
t _d	Propagation delay time	From change in B to change in OUT	10		μs
B _{ND}	Input-referred RMS noise density	V _{CC} = 5 V	130		nT/√Hz
		V _{CC} = 3.3 V	215		
B _N	Input-referred noise	B _{ND} × 6.6 × √20 kHz	V _{CC} = 5 V	0.12	mT _{PP}
			V _{CC} = 3.3 V	0.2	
V _N	Output-referred noise ⁽²⁾	B _N × S	DRV5055A1, DRV5055A5	12	mV _{PP}
			DRV5055A2	6	
			DRV5055A3	3	
			DRV5055A4	1.5	

(1) B is the applied magnetic flux density.

(2) V_N describes voltage noise on the device output. If the full device bandwidth is not needed, noise can be reduced with an RC filter.

6.6 Magnetic Characteristics

for $V_{CC} = 3\text{ V}$ to 3.63 V and 4.5 V to 5.5 V , over operating free-air temperature range (unless otherwise noted)

PARAMETER		TEST CONDITIONS ⁽¹⁾	MIN	TYP	MAX	UNIT	
V_Q	Quiescent voltage	$B = 0\text{ mT}$, $T_A = 25^\circ\text{C}$	$V_{CC} = 5\text{ V}$	2.43	2.5	2.57	V
			$V_{CC} = 3.3\text{ V}$	1.59	1.65	1.71	
$V_{Q\Delta T}$	Quiescent voltage temperature drift	$B = 0\text{ mT}$, $T_A = -40^\circ\text{C}$ to 150°C versus 25°C	$\pm 1\% \times V_{CC}$			V	
V_{QRE}	Quiescent voltage ratiometry error ⁽²⁾		$\pm 0.2\%$				
$V_{Q\Delta L}$	Quiescent voltage lifetime drift	High-temperature operating stress for 1000 hours	< 0.5%				
S	Sensitivity	$V_{CC} = 5\text{ V}$, $T_A = 25^\circ\text{C}$	DRV5055A1	95	100	105	mV/mT
			DRV5055A2	47.5	50	52.5	
			DRV5055A3	23.8	25	26.2	
			DRV5055A4	11.9	12.5	13.2	
			DRV5055A5	-105	-100	-95	
		$V_{CC} = 3.3\text{ V}$, $T_A = 25^\circ\text{C}$	DRV5055A1	57	60	63	
			DRV5055A2	28.5	30	31.5	
			DRV5055A3	14.3	15	15.8	
			DRV5055A4	7.1	7.5	7.9	
			DRV5055A5	-63	-60	-57	
B_L	Linear magnetic sensing range ^{(3) (4)}	$V_{CC} = 5\text{ V}$, $T_A = 25^\circ\text{C}$	DRV5055A1, DRV5055A5	± 21		mT	
			DRV5055A2	± 42			
			DRV5055A3	± 85			
			DRV5055A4	± 169			
		$V_{CC} = 3.3\text{ V}$, $T_A = 25^\circ\text{C}$	DRV5055A1, DRV5055A5	± 22			
			DRV5055A2	± 44			
			DRV5055A3	± 88			
			DRV5055A4	± 176			
V_L	Linear range of output voltage ⁽⁴⁾		0.2	$V_{CC} - 0.2$	V		
S_{TC}	Sensitivity temperature compensation for magnets ⁽⁵⁾		0.12		%/ $^\circ\text{C}$		
S_{LE}	Sensitivity linearity error ⁽⁴⁾	V_{OUT} is within V_L	$\pm 1\%$				
S_{SE}	Sensitivity symmetry error ⁽⁴⁾	V_{OUT} is within V_L	$\pm 1\%$				
S_{RE}	Sensitivity ratiometry error ⁽²⁾	$T_A = 25^\circ\text{C}$, with respect to $V_{CC} = 3.3\text{ V}$ or 5 V	-2.5%	2.5%			
$S_{\Delta L}$	Sensitivity lifetime drift	High-temperature operating stress for 1000 hours	<0.5%				

(1) B is the applied magnetic flux density.

(2) See the [Ratiometric Architecture](#) section.

(3) B_L describes the minimum linear sensing range at 25°C taking into account the maximum V_Q and Sensitivity tolerances.

(4) See the [Sensitivity Linearity](#) section.

(5) S_{TC} describes the rate the device increases Sensitivity with temperature. For more information, see the [Sensitivity Temperature Compensation for Magnets](#) section.

6.7 Typical Characteristics

for $T_A = 25^\circ\text{C}$ (unless otherwise noted)

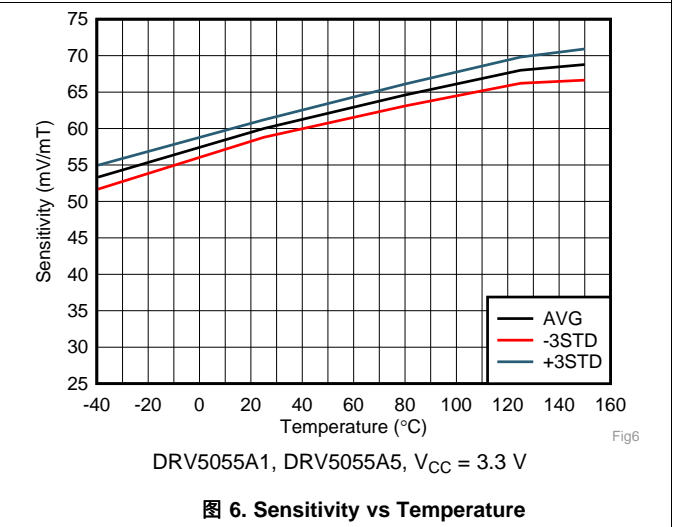
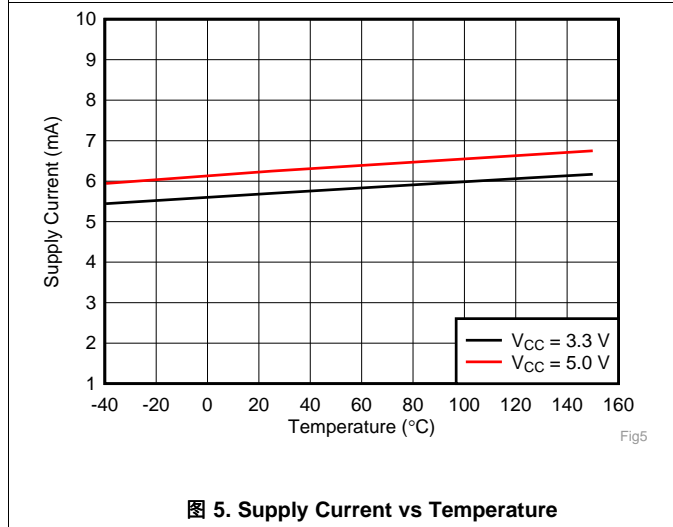
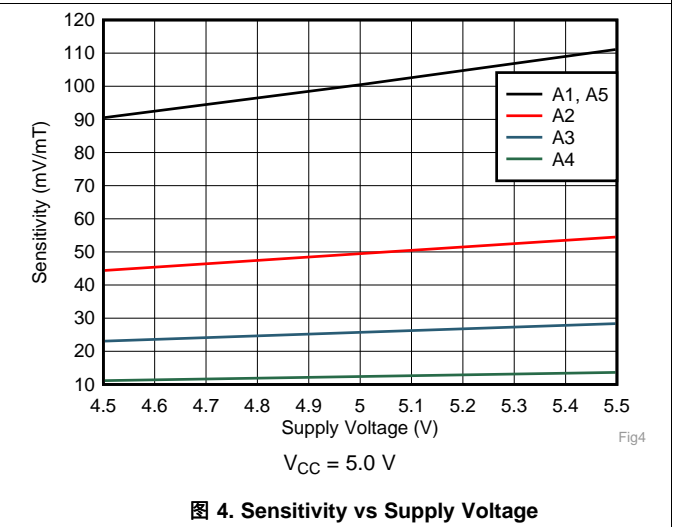
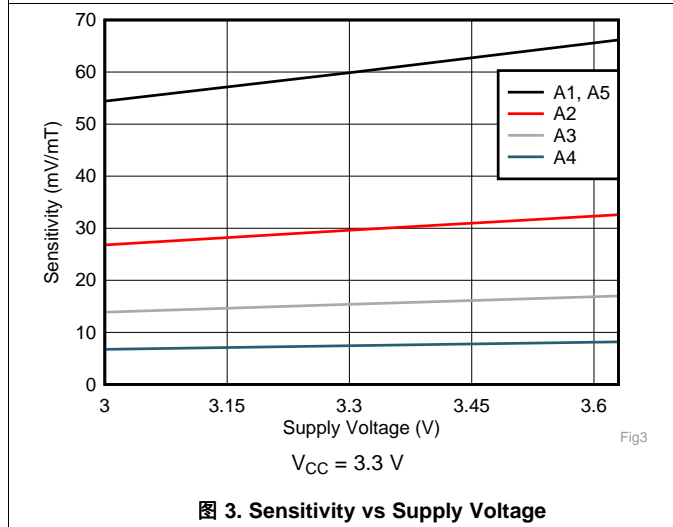
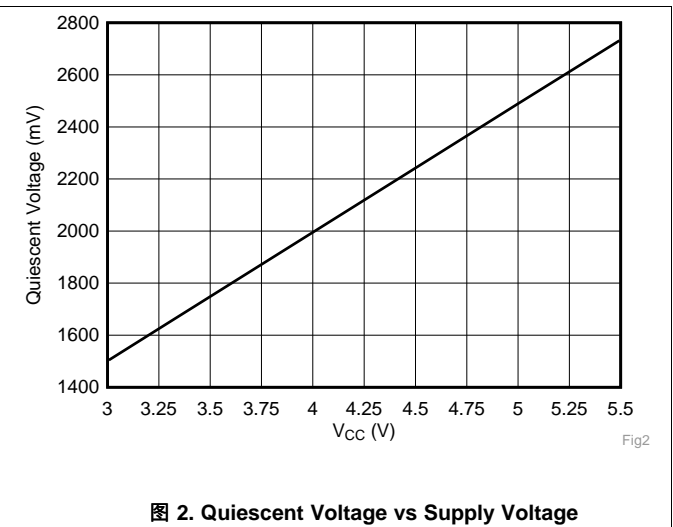
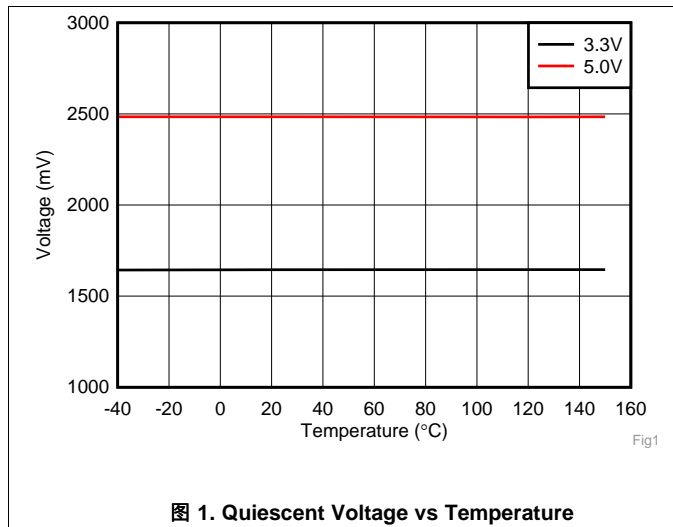

Typical Characteristics (接下页)

for $T_A = 25^\circ\text{C}$ (unless otherwise noted)

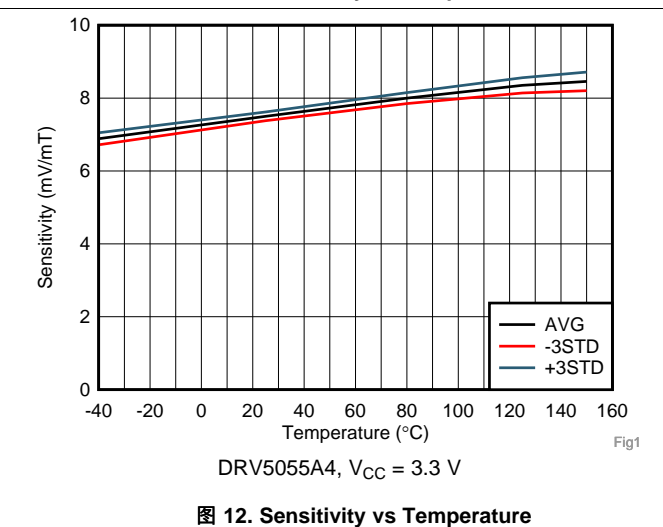
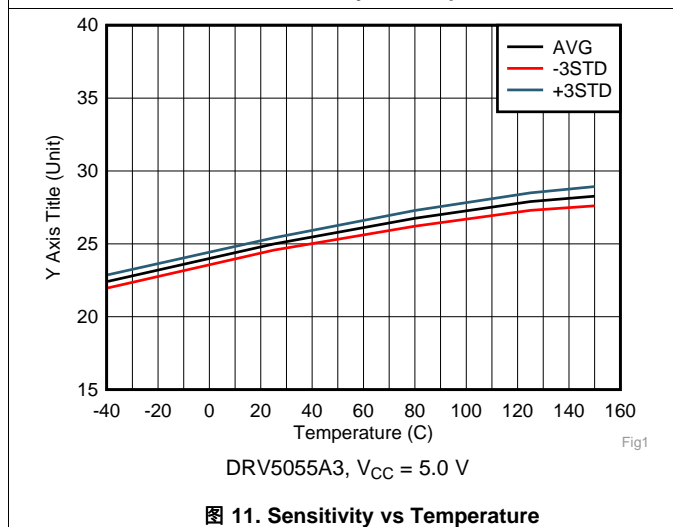
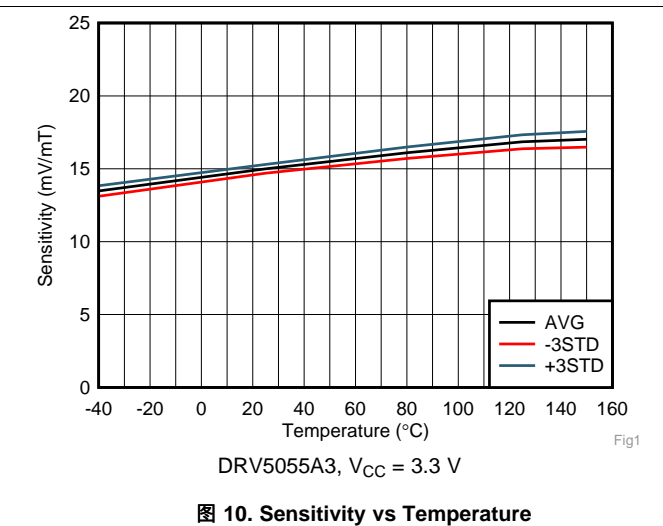
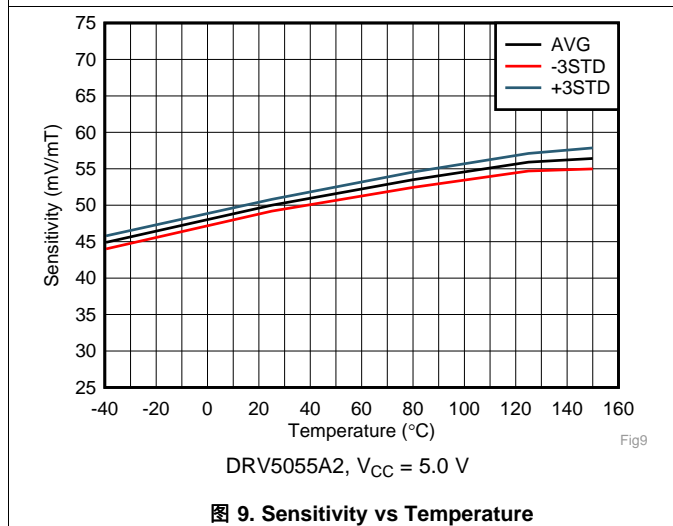
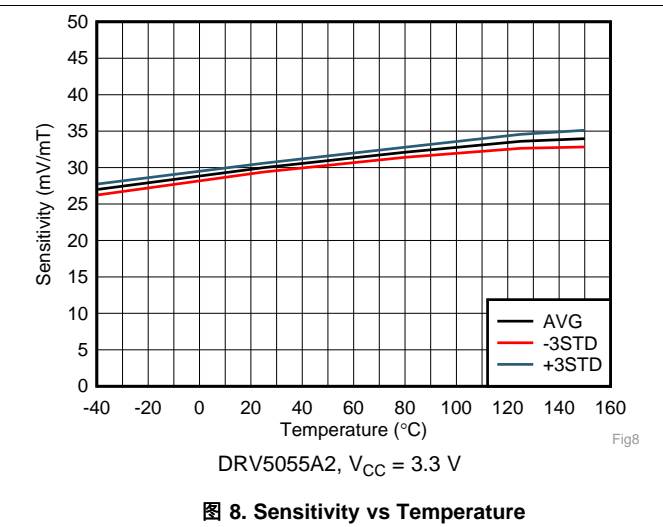
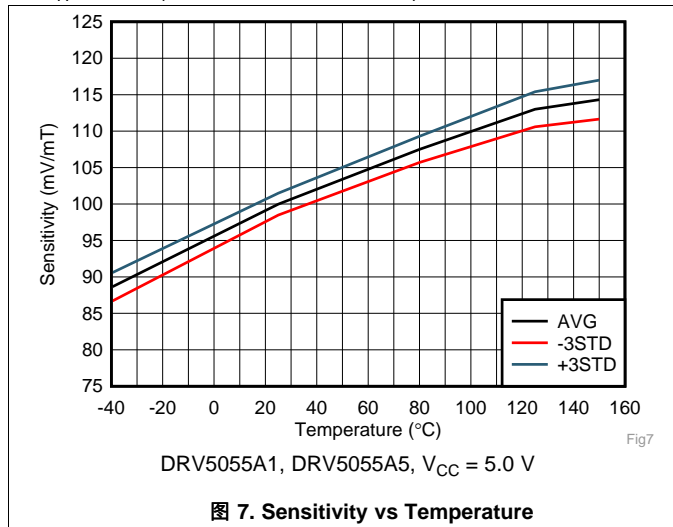

Typical Characteristics (接下页)

for $T_A = 25^\circ\text{C}$ (unless otherwise noted)

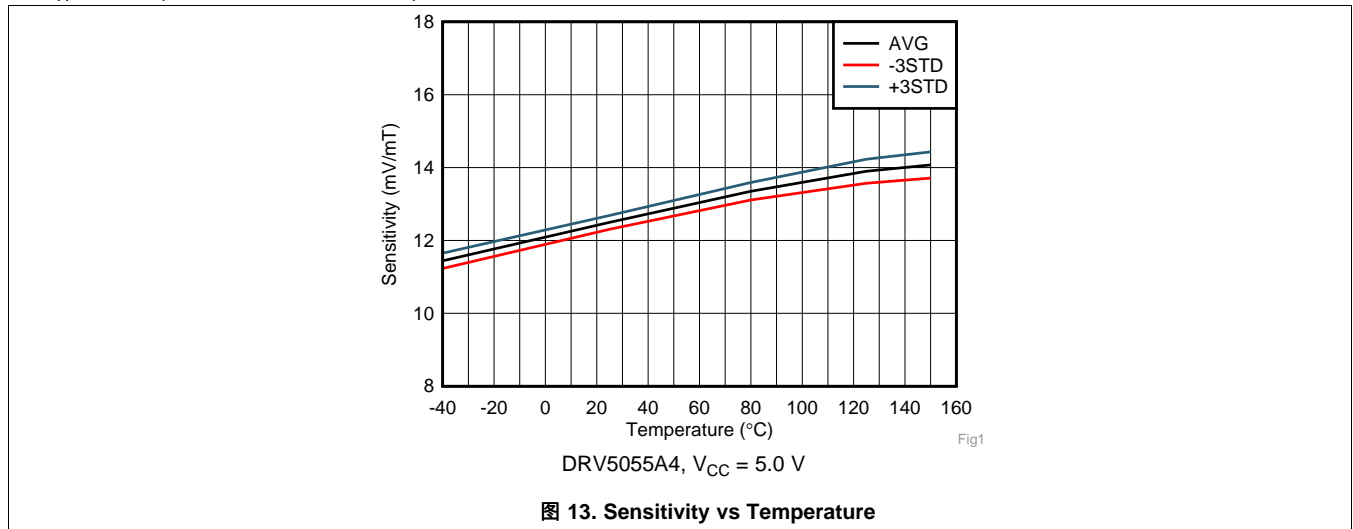

7 Detailed Description

7.1 Overview

The DRV5055-Q1 is a 3-pin linear Hall effect sensor with fully integrated signal conditioning, temperature compensation circuits, mechanical stress cancellation, and amplifiers. The device operates from 3.3-V and 5-V ($\pm 10\%$) power supplies, measures magnetic flux density, and outputs a proportional analog voltage that is referenced to V_{CC} .

7.2 Functional Block Diagram

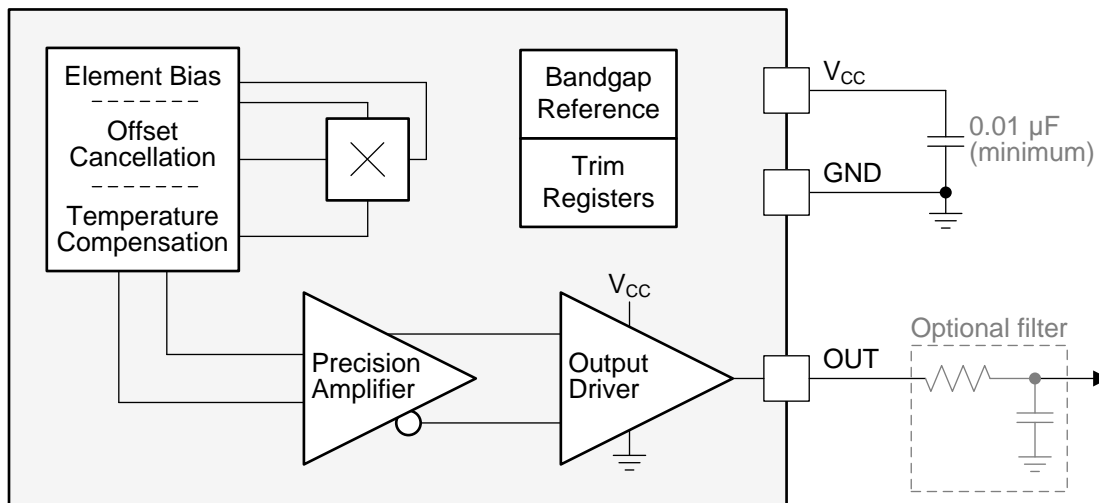

7.3 Feature Description

7.3.1 Magnetic Flux Direction

As shown in 图 14, the DRV5055-Q1 is sensitive to the magnetic field component that is perpendicular to the top of the package.



图 14. Direction of Sensitivity

Feature Description (接下页)

Magnetic flux that travels from the bottom to the top of the package is considered positive in this document. This condition exists when a south magnetic pole is near the top (marked-side) of the package. Magnetic flux that travels from the top to the bottom of the package results in negative millitesla values.

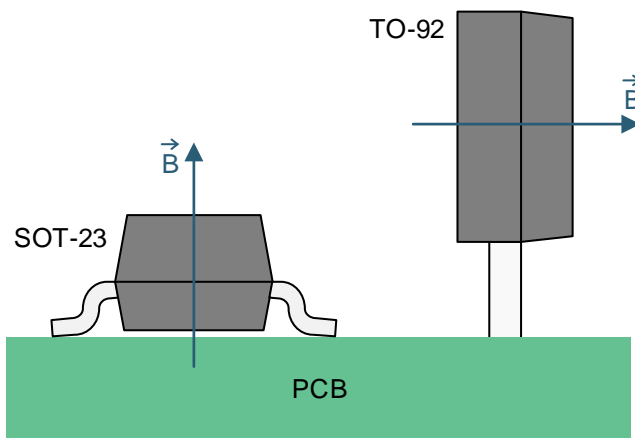

图 15. The Flux Direction for Positive B

7.3.2 Magnetic Response

When the DRV5055-Q1 is powered, the DRV5055-Q1 outputs an analog voltage according to 公式 1:

$$V_{OUT} = V_Q + B \times (\text{Sensitivity}_{(25^\circ\text{C})} \times (1 + S_{TC} \times (T_A - 25^\circ\text{C})))$$

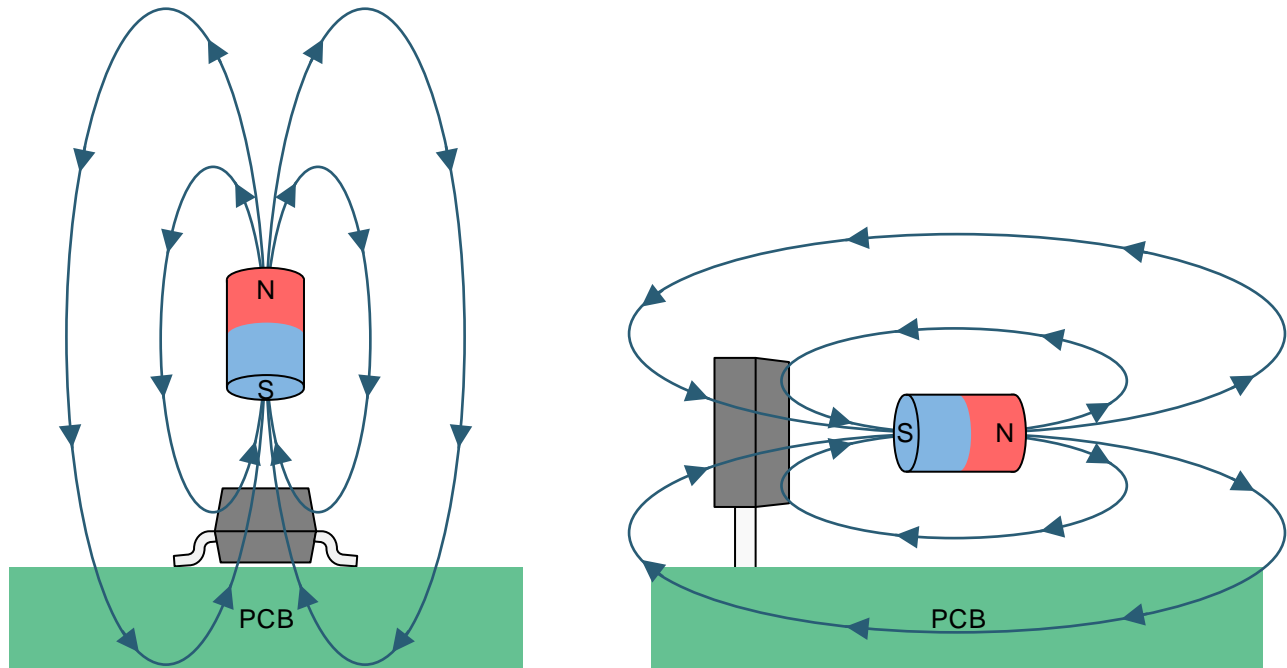
where

- V_Q is typically half of V_{CC}
- B is the applied magnetic flux density
- $\text{Sensitivity}_{(25^\circ\text{C})}$ depends on the device option and V_{CC}
- S_{TC} is typically 0.12%/°C
- T_A is the ambient temperature
- V_{OUT} is within the V_L range

(1)

As an example, consider the DRV5055A3 with $V_{CC} = 3.3\text{ V}$, a temperature of 50°C , and 67 mT applied. Excluding tolerances, $V_{OUT} = 1650\text{ mV} + 67\text{ mT} \times (15\text{ mV/mT} \times (1 + 0.0012/^\circ\text{C} \times (50^\circ\text{C} - 25^\circ\text{C}))) = 2685\text{ mV}$.

7.3.3 Sensitivity Linearity

The device produces a linear response when the output voltage is within the specified V_L range. Outside this range, sensitivity is reduced and nonlinear. 图 16 and 图 17 graph the magnetic response.

Feature Description (接下页)



图 16. Magnetic Response of the A1, A2, A3, A4 Versions



图 17. Magnetic Response of the A5 Version

公式 2 calculates parameter B_L , the minimum linear sensing range at 25°C taking into account the maximum quiescent voltage and sensitivity tolerances.

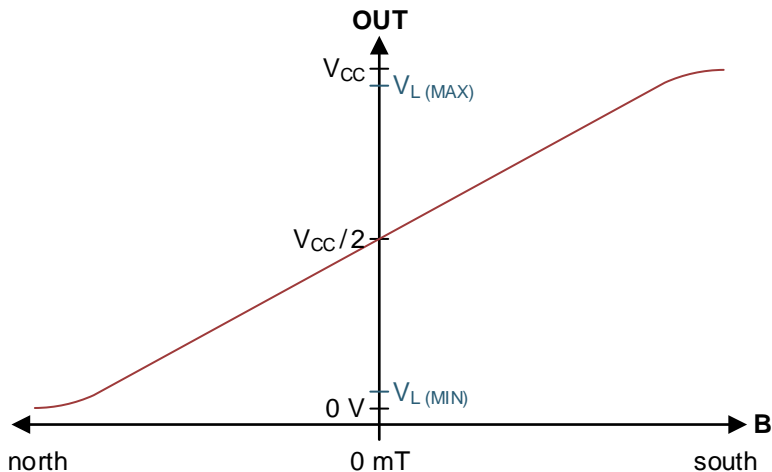
$$B_{L(MIN)} = \frac{V_{L(MAX)} - V_{Q(MAX)}}{S_{(MAX)}} \tag{2}$$

The parameter S_{LE} defines linearity error as the difference in sensitivity between any two positive B values, and any two negative B values, while the output is within the V_L range.

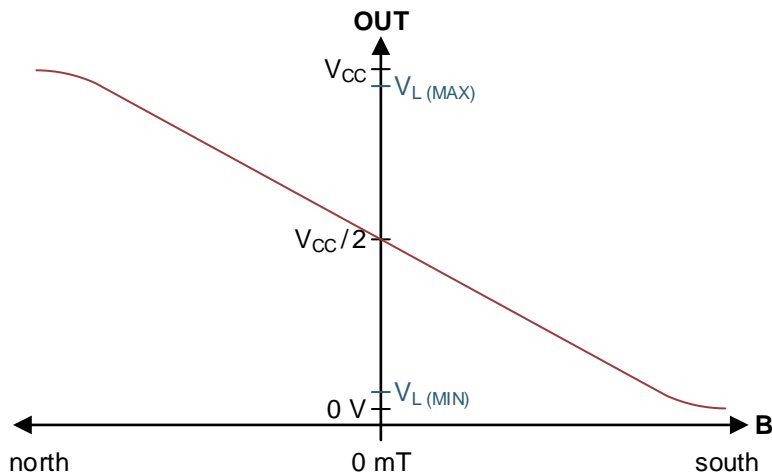
The parameter S_{SE} defines symmetry error as the difference in sensitivity between any positive B value and the negative B value of the same magnitude, while the output voltage is within the V_L range.

7.3.4 Ratiometric Architecture

The DRV5055-Q1 has a ratiometric analog architecture that scales the quiescent voltage and sensitivity linearly with the power-supply voltage. For example, the quiescent voltage and sensitivity are 5% higher when $V_{CC} = 5.25\text{ V}$ compared to $V_{CC} = 5\text{ V}$. This behavior enables external ADCs to digitize a consistent value regardless of the power-supply voltage tolerance, when the ADC uses V_{CC} as its reference.

Feature Description (接下页)

公式 3 calculates the sensitivity ratiometry error:

$$S_{RE} = 1 - \frac{S_{(V_{CC})} / S_{(5V)}}{V_{CC} / 5V} \text{ for } V_{CC} = 4.5 \text{ V to } 5.5 \text{ V}, \quad S_{RE} = 1 - \frac{S_{(V_{CC})} / S_{(3.3V)}}{V_{CC} / 3.3V} \text{ for } V_{CC} = 3 \text{ V to } 3.63 \text{ V}$$

where

- $S_{(V_{CC})}$ is the sensitivity at the current V_{CC} voltage
 - $S_{(5V)}$ or $S_{(3.3V)}$ is the sensitivity when $V_{CC} = 5 \text{ V}$ or 3.3 V
 - V_{CC} is the current V_{CC} voltage
- (3)

公式 4 calculates quiescent voltage ratiometry error:

$$V_{QRE} = 1 - \frac{V_{Q(V_{CC})} / V_{Q(5V)}}{V_{CC} / 5V} \text{ for } V_{CC} = 4.5 \text{ V to } 5.5 \text{ V}, \quad V_{QRE} = 1 - \frac{V_{Q(V_{CC})} / V_{Q(3.3V)}}{V_{CC} / 3.3V} \text{ for } V_{CC} = 3 \text{ V to } 3.63 \text{ V}$$

where

- $V_{Q(V_{CC})}$ is the quiescent voltage at the current V_{CC} voltage
 - $V_{Q(5V)}$ or $V_{Q(3.3V)}$ is the quiescent voltage when $V_{CC} = 5 \text{ V}$ or 3.3 V
 - V_{CC} is the current V_{CC} voltage
- (4)

7.3.5 Operating V_{CC} Ranges

The DRV5055-Q1 has two recommended operating V_{CC} ranges: 3 V to 3.63 V and 4.5 V to 5.5 V. When V_{CC} is in the middle region between 3.63 V to 4.5 V, the device continues to function, but sensitivity is less known because there is a crossover threshold near 4 V that adjusts device characteristics.

7.3.6 Sensitivity Temperature Compensation for Magnets

Magnets generally produce weaker fields as temperature increases. The DRV5055-Q1 compensates by increasing sensitivity with temperature, as defined by the parameter S_{TC} . The sensitivity at $T_A = 125^\circ\text{C}$ is typically 12% higher than at $T_A = 25^\circ\text{C}$. The DRV5055A5 absolute value of sensitivity increases with temperature.

7.3.7 Power-On Time

After the V_{CC} voltage is applied, the DRV5055-Q1 requires a short initialization time before the output is set. The parameter t_{ON} describes the time from when V_{CC} crosses 3 V until OUT is within 5% of V_Q , with 0 mT applied and no load attached to OUT. 图 18 shows this timing diagram.



图 18. t_{ON} Definition

Feature Description (接下页)

7.3.8 Hall Element Location

图 19 shows the location of the sensing element inside each package option.

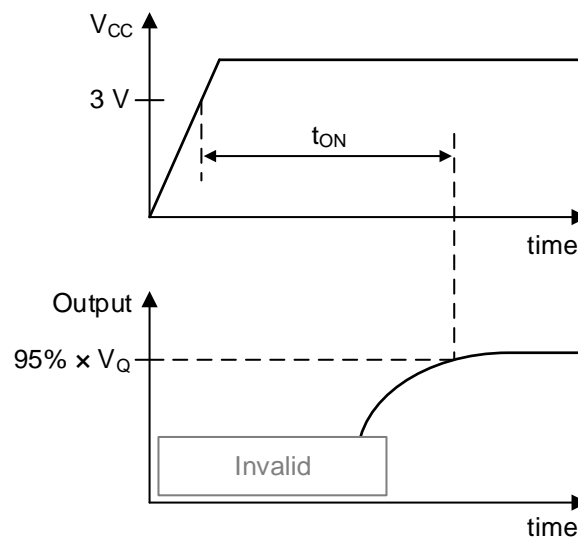

图 19. Hall Element Location

7.4 Device Functional Modes

The DRV5055-Q1 has one mode of operation that applies when the *Recommended Operating Conditions* are met.

8 Application and Implementation

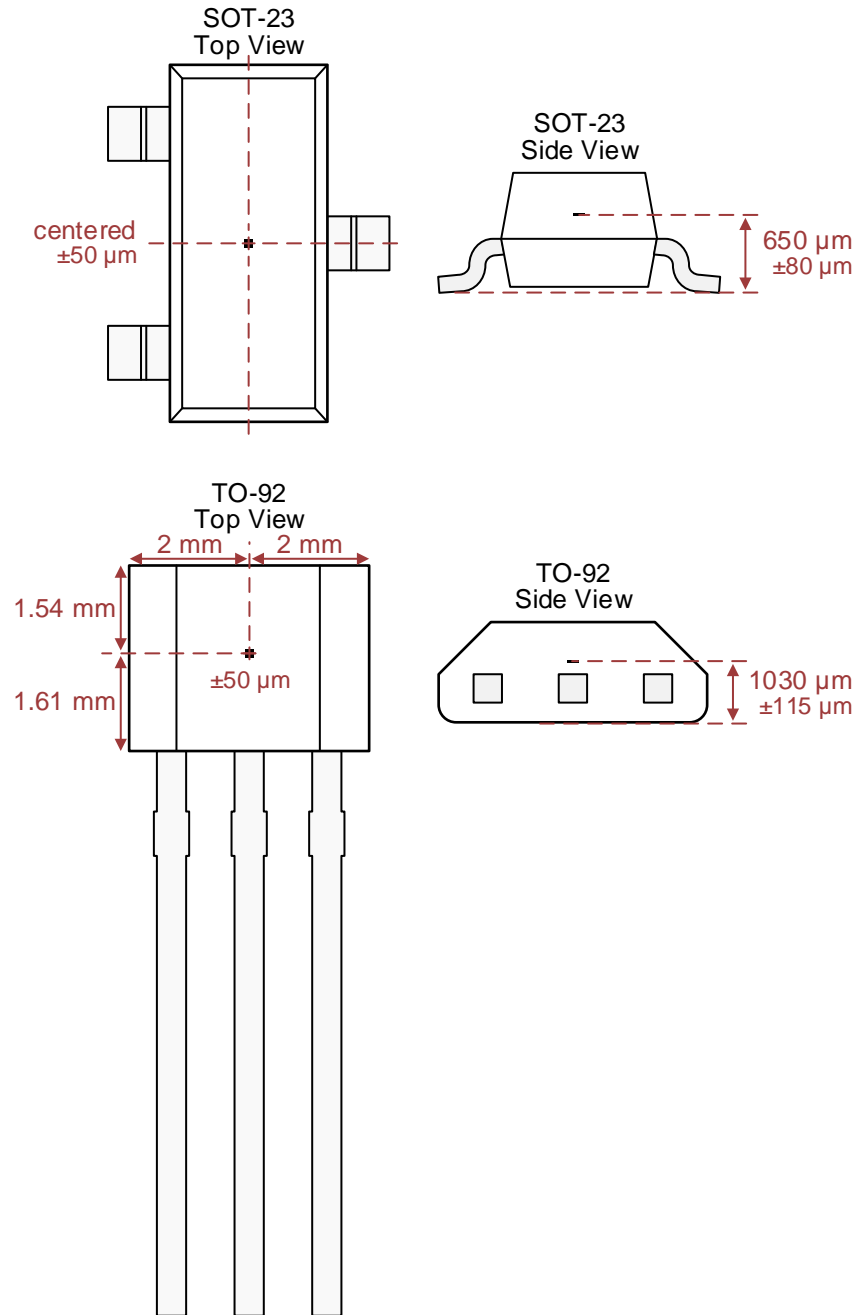
注

Information in the following applications sections is not part of the TI component specification, and TI does not warrant its accuracy or completeness. TI's customers are responsible for determining suitability of components for their purposes. Customers should validate and test their design implementation to confirm system functionality.

8.1 Application Information

8.1.1 Selecting the Sensitivity Option

Select the highest DRV5055-Q1 sensitivity option that can measure the required range of magnetic flux density, so that the output voltage swing is maximized.

Larger-sized magnets and farther sensing distances can generally enable better positional accuracy than very small magnets at close distances, because magnetic flux density increases exponentially with the proximity to a magnet. TI created an online tool to help with simple magnet calculations at <http://www.ti.com/product/drv5013>.

8.1.2 Temperature Compensation for Magnets

The DRV5055-Q1 temperature compensation is designed to directly compensate the average drift of neodymium (NdFeB) magnets and partially compensate ferrite magnets. The residual induction (B_r) of a magnet typically reduces by 0.12%/°C for NdFeB, and 0.20%/°C for ferrite. When the operating temperature of a system is reduced, temperature drift errors are also reduced.

8.1.3 Adding a Low-Pass Filter

As shown in the *Functional Block Diagram*, an RC low-pass filter can be added to the device output for the purpose of minimizing voltage noise when the full 20-kHz bandwidth is not needed. This filter can improve the signal-to-noise ratio (SNR) and overall accuracy. Do not connect a capacitor directly to the device output without a resistor in between because doing so can make the output unstable.

8.1.4 Designing for Wire Break Detection

Some systems must detect if interconnect wires become open or shorted. The DRV5055-Q1 can support this function.

First, select a sensitivity option that causes the output voltage to stay within the V_L range during normal operation. Second, add a pullup resistor between OUT and V_{CC} . TI recommends a value between 20 k Ω to 100 k Ω , and the current through OUT must not exceed the I_O specification, including current going into an external ADC. Then, if the output voltage is ever measured to be within 150 mV of V_{CC} or GND, a fault condition exists. 图 20 shows the circuit, and 表 1 describes fault scenarios.



图 20. Wire Fault Detection Circuit

表 1. Fault Scenarios and the Resulting V_{OUT}

FAULT SCENARIO	V_{OUT}
V_{CC} disconnects	Close to GND
GND disconnects	Close to V_{CC}
V_{CC} shorts to OUT	Close to V_{CC}
GND shorts to OUT	Close to GND

8.2 Typical Application

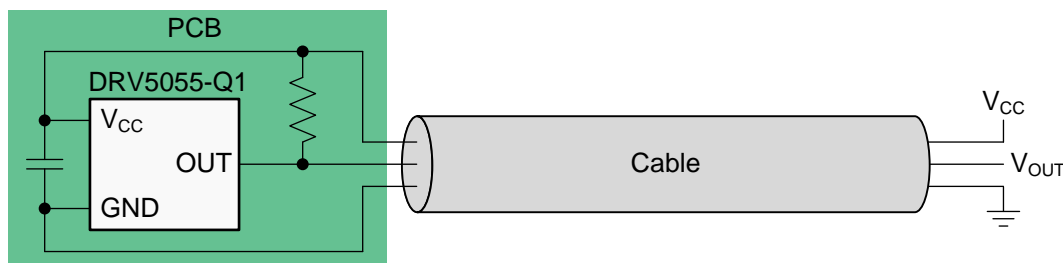

图 21. Common Magnet Orientation

8.2.1 Design Requirements

Use the parameters listed in 表 2 for this design example.

表 2. Design Parameters

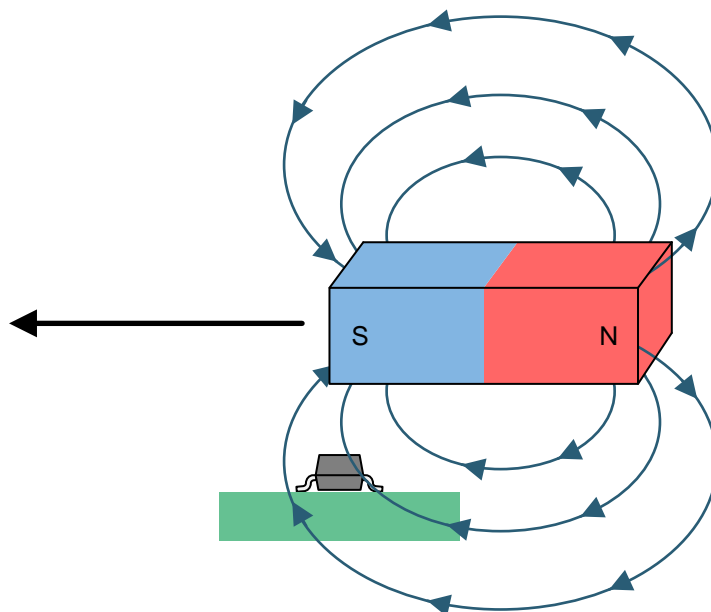
DESIGN PARAMETER	EXAMPLE VALUE
V_{CC}	5 V
Magnet	15 × 5 × 5 mm NdFeB
Travel distance	12 mm
Maximum B at the sensor at 25°C	±75 mT
Device option	DRV5055A3

8.2.2 Detailed Design Procedure

Linear Hall effect sensors provide flexibility in mechanical design, because many possible magnet orientations and movements produce a usable response from the sensor. 图 21 shows one of the most common orientations, which uses the full north to south range of the sensor and causes a close-to-linear change in magnetic flux density as the magnet moves across.

When designing a linear magnetic sensing system, always consider these three variables: the magnet, sensing distance, and the range of the sensor. Select the DRV5055-Q1 with the highest sensitivity that has a B_L (linear magnetic sensing range) that is larger than the maximum magnetic flux density in the application. To determine the magnetic flux density the sensor receives, TI recommends using magnetic field simulation software, referring to magnet specifications, and testing.

8.2.3 Application Curve

图 22 shows the simulated magnetic flux from a NdFeB magnet.



图 22. Simulated Magnetic Flux

8.3 Do's and Don'ts

Because the Hall element is sensitive to magnetic fields that are perpendicular to the top of the package, a correct magnet approach must be used for the sensor to detect the field.  23 shows correct and incorrect approaches.

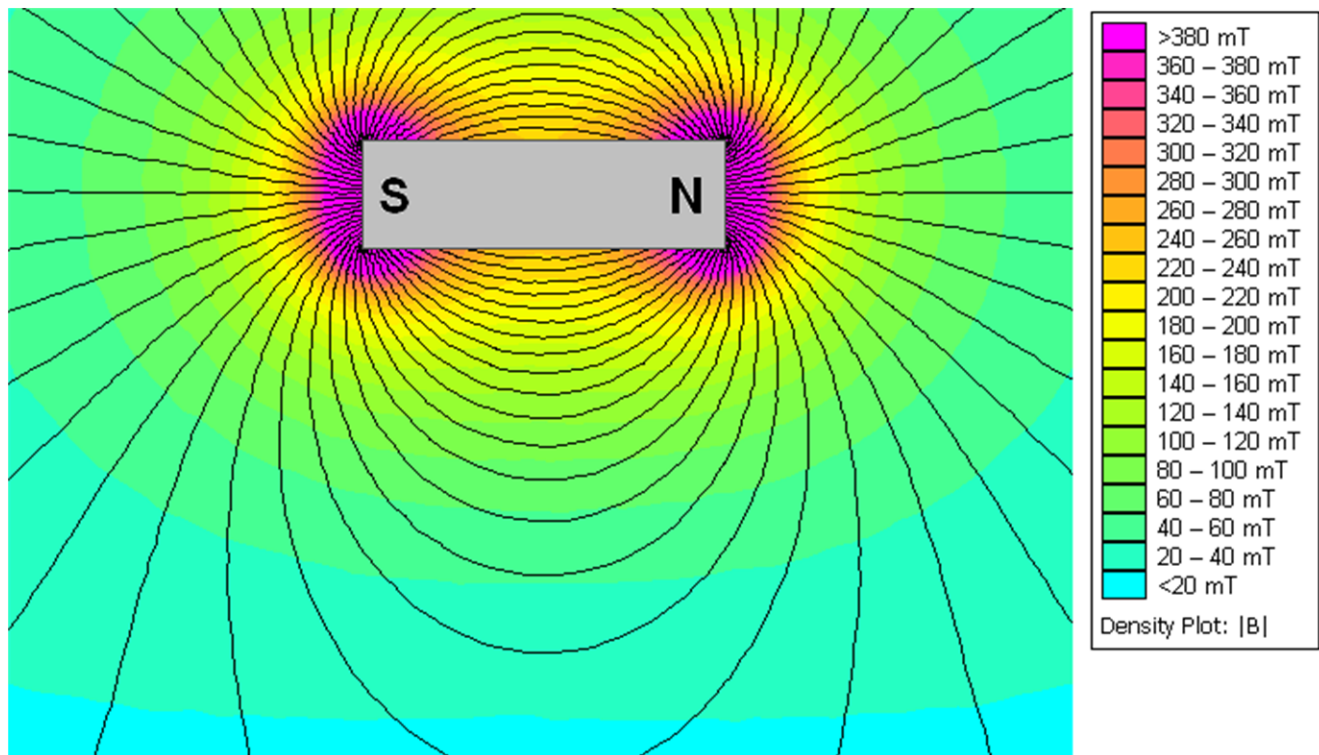
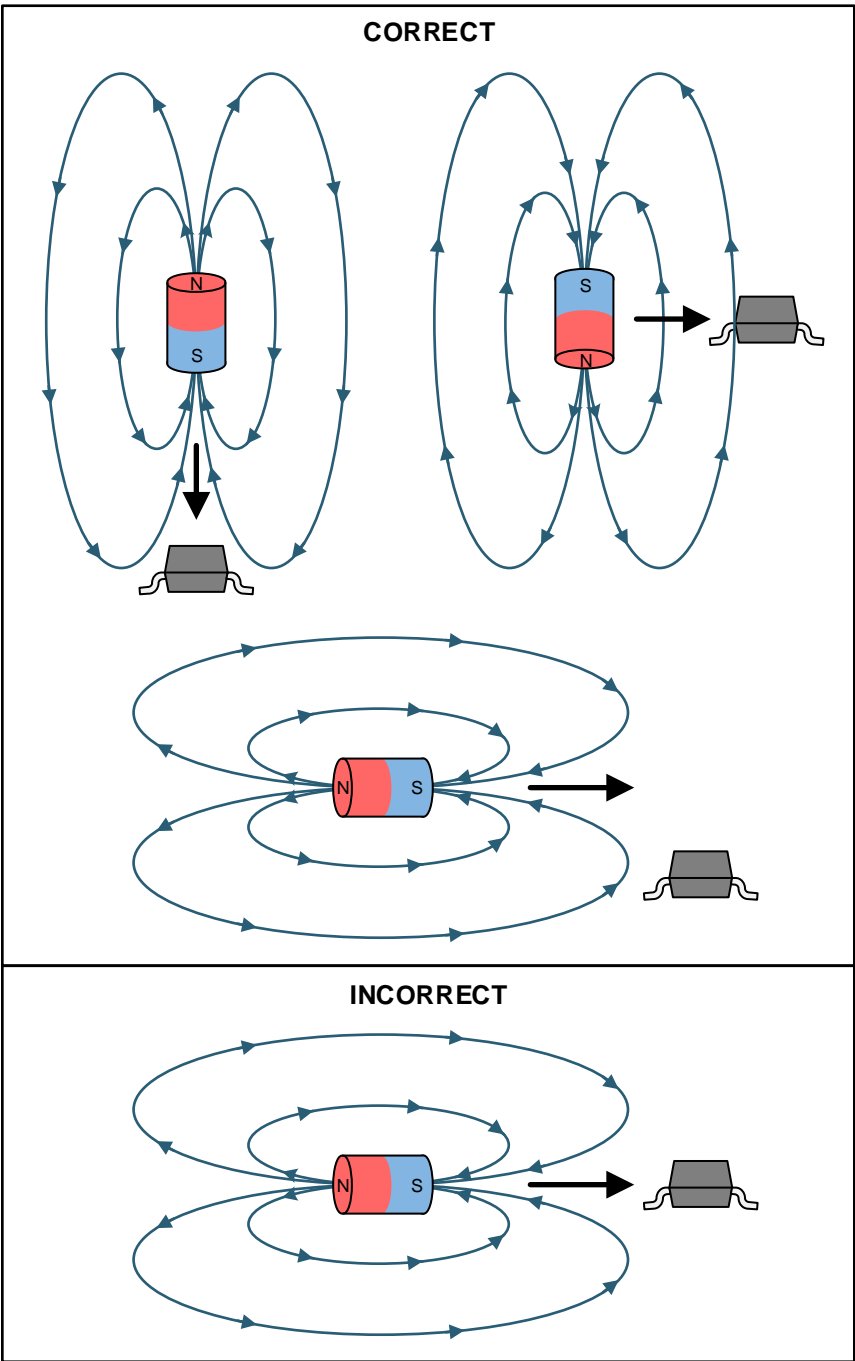

图 23. Correct and Incorrect Magnet Approaches

9 Power Supply Recommendations

A decoupling capacitor close to the device must be used to provide local energy with minimal inductance. TI recommends using a ceramic capacitor with a value of at least 0.01 μF .

10 Layout

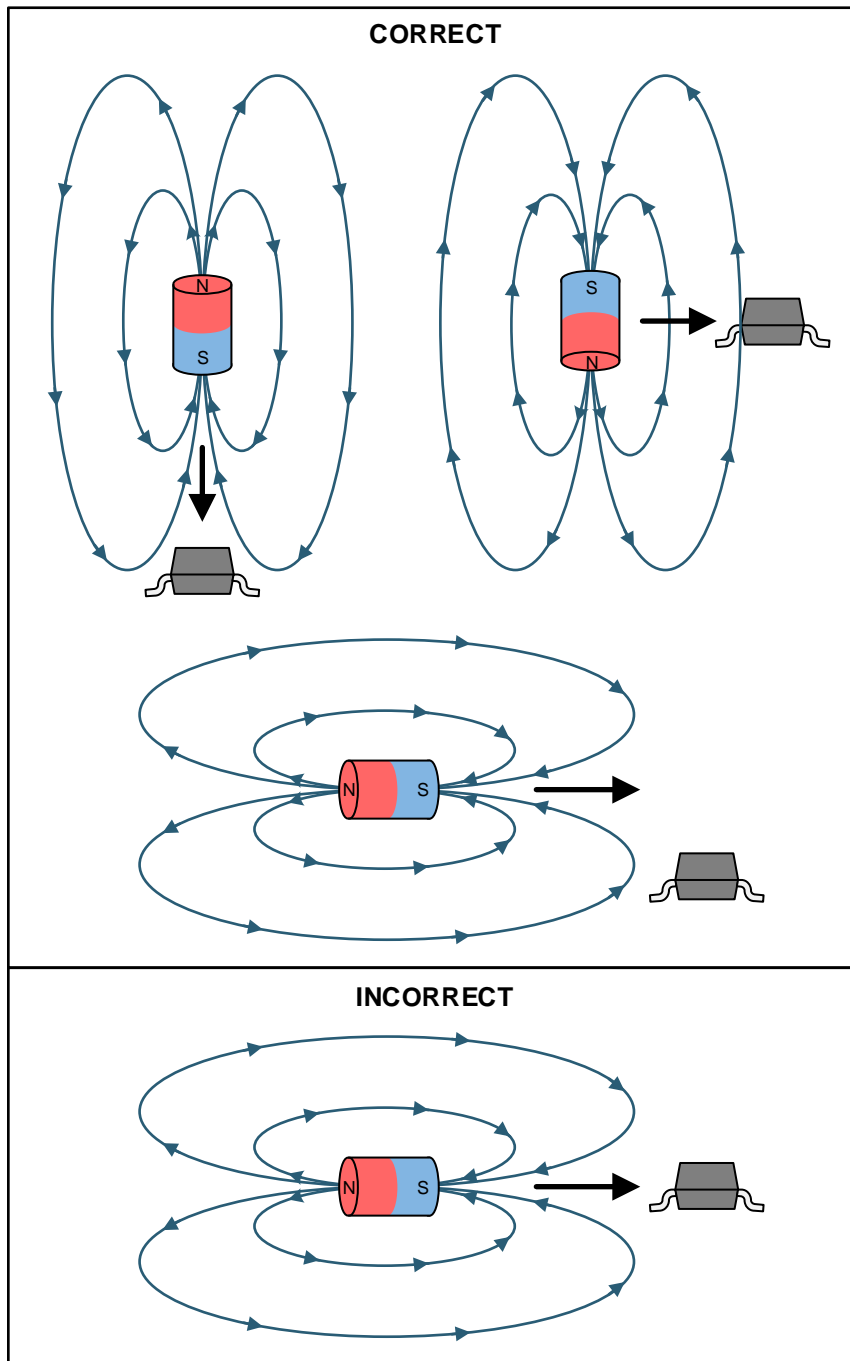
10.1 Layout Guidelines

Magnetic fields pass through most nonferromagnetic materials with no significant disturbance. Embedding Hall effect sensors within plastic or aluminum enclosures and sensing magnets on the outside is common practice. Magnetic fields also easily pass through most printed-circuit boards, which makes placing the magnet on the opposite side possible.

10.2 Layout Examples



图 24. Layout Examples

11 器件和文档支持

11.1 文档支持

11.1.1 相关文档

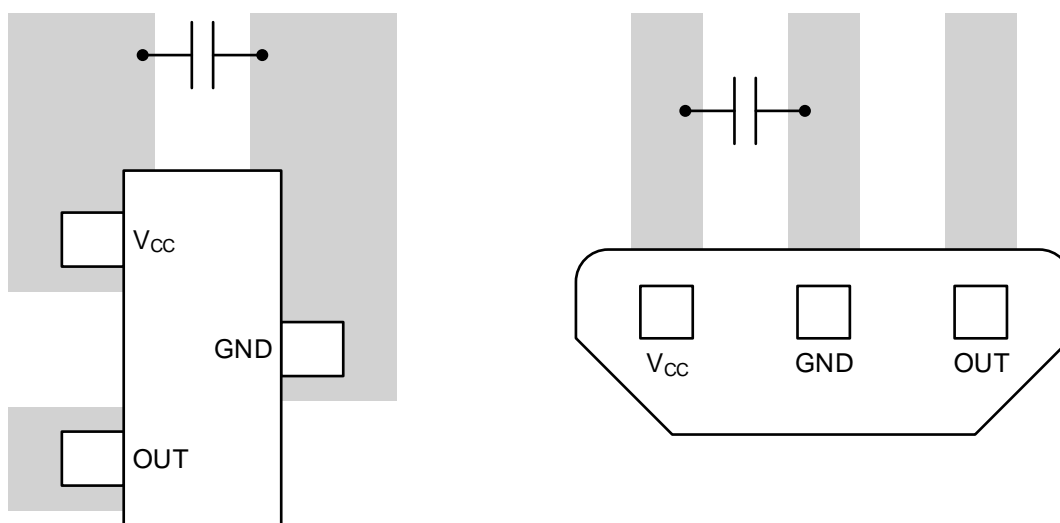
请参阅如下相关文档：

- 《利用线性霍尔效应传感器测量角度》
- 《增量旋转编码器设计注意事项》

11.2 接收文档更新通知

要接收文档更新通知，请导航至 TI.com.cn 上的器件产品文件夹。单击右上角的 [通知我](#) 进行注册，即可每周接收产品信息更改摘要。有关更改的详细信息，请查看任何已修订文档中包含的修订历史记录。

11.3 社区资源

下列链接提供到 TI 社区资源的连接。链接的内容由各个分销商“按照原样”提供。这些内容并不构成 TI 技术规范，并且不一定反映 TI 的观点；请参阅 TI 的《使用条款》。

TI E2E™ 在线社区 *TI 的工程师对工程师 (E2E) 社区*。此社区的创建目的在于促进工程师之间的协作。在 e2e.ti.com 中，您可以咨询问题、分享知识、拓展思路并与同行工程师一道帮助解决问题。

设计支持 *TI 参考设计支持* 可帮助您快速查找有帮助的 E2E 论坛、设计支持工具以及技术支持的联系信息。

11.4 商标

E2E is a trademark of Texas Instruments.
All other trademarks are the property of their respective owners.

11.5 静电放电警告



ESD 可能会损坏该集成电路。德州仪器 (TI) 建议通过适当的预防措施处理所有集成电路。如果不遵守正确的处理措施和安装程序，可能会损坏集成电路。

ESD 的损坏小至导致微小的性能降级，大至整个器件故障。精密的集成电路可能更容易受到损坏，这是因为非常细微的参数更改都可能会导致器件与其发布的规格不相符。

11.6 术语表

SLYZ022 — *TI 术语表*。

这份术语表列出并解释术语、缩写和定义。

12 机械、封装和可订购信息

以下页面包含机械、封装和可订购信息。这些信息是指定器件的最新可用数据。数据如有变更，恕不另行通知，且不会对此文档进行修订。如需获取此产品说明书的浏览器版本，请查阅左侧的导航栏。

PACKAGING INFORMATION

Orderable Device	Status (1)	Package Type	Package Drawing	Pins	Package Qty	Eco Plan (2)	Lead finish/ Ball material (6)	MSL Peak Temp (3)	Op Temp (°C)	Device Marking (4/5)	Samples
DRV5055A1EDBZRQ1	ACTIVE	SOT-23	DBZ	3	3000	RoHS & Green	SN	Level-3-260C-168 HR	-40 to 150	55A1Z	Samples
DRV5055A1ELPGMQ1	ACTIVE	TO-92	LPG	3	3000	RoHS & Green	SN	N / A for Pkg Type	-40 to 150	55A1Z	Samples
DRV5055A1ELPGQ1	ACTIVE	TO-92	LPG	3	1000	RoHS & Green	SN	N / A for Pkg Type	-40 to 150	55A1Z	Samples
DRV5055A2EDBZRQ1	ACTIVE	SOT-23	DBZ	3	3000	RoHS & Green	SN	Level-3-260C-168 HR	-40 to 150	55A2Z	Samples
DRV5055A2ELPGMQ1	ACTIVE	TO-92	LPG	3	3000	RoHS & Green	SN	N / A for Pkg Type	-40 to 150	55A2Z	Samples
DRV5055A2ELPGQ1	ACTIVE	TO-92	LPG	3	1000	RoHS & Green	SN	N / A for Pkg Type	-40 to 150	55A2Z	Samples
DRV5055A3EDBZRQ1	ACTIVE	SOT-23	DBZ	3	3000	RoHS & Green	SN	Level-3-260C-168 HR	-40 to 150	55A3Z	Samples
DRV5055A3ELPGMQ1	ACTIVE	TO-92	LPG	3	3000	RoHS & Green	SN	N / A for Pkg Type	-40 to 150	55A3Z	Samples
DRV5055A3ELPGQ1	ACTIVE	TO-92	LPG	3	1000	RoHS & Green	SN	N / A for Pkg Type	-40 to 150	55A3Z	Samples
DRV5055A4EDBZRQ1	ACTIVE	SOT-23	DBZ	3	3000	RoHS & Green	SN	Level-3-260C-168 HR	-40 to 150	55A4Z	Samples
DRV5055A4ELPGMQ1	ACTIVE	TO-92	LPG	3	3000	RoHS & Green	SN	N / A for Pkg Type	-40 to 150	55A4Z	Samples
DRV5055A4ELPGQ1	ACTIVE	TO-92	LPG	3	1000	RoHS & Green	SN	N / A for Pkg Type	-40 to 150	55A4Z	Samples

(1) The marketing status values are defined as follows:

ACTIVE: Product device recommended for new designs.

LIFEBUY: TI has announced that the device will be discontinued, and a lifetime-buy period is in effect.

NRND: Not recommended for new designs. Device is in production to support existing customers, but TI does not recommend using this part in a new design.

PREVIEW: Device has been announced but is not in production. Samples may or may not be available.

OBSOLETE: TI has discontinued the production of the device.

(2) **RoHS:** TI defines "RoHS" to mean semiconductor products that are compliant with the current EU RoHS requirements for all 10 RoHS substances, including the requirement that RoHS substance do not exceed 0.1% by weight in homogeneous materials. Where designed to be soldered at high temperatures, "RoHS" products are suitable for use in specified lead-free processes. TI may reference these types of products as "Pb-Free".

RoHS Exempt: TI defines "RoHS Exempt" to mean products that contain lead but are compliant with EU RoHS pursuant to a specific EU RoHS exemption.

Green: TI defines "Green" to mean the content of Chlorine (Cl) and Bromine (Br) based flame retardants meet JS709B low halogen requirements of <=1000ppm threshold. Antimony trioxide based flame retardants must also meet the <=1000ppm threshold requirement.

- (3) MSL, Peak Temp. - The Moisture Sensitivity Level rating according to the JEDEC industry standard classifications, and peak solder temperature.
- (4) There may be additional marking, which relates to the logo, the lot trace code information, or the environmental category on the device.
- (5) Multiple Device Markings will be inside parentheses. Only one Device Marking contained in parentheses and separated by a "~" will appear on a device. If a line is indented then it is a continuation of the previous line and the two combined represent the entire Device Marking for that device.
- (6) Lead finish/Ball material - Orderable Devices may have multiple material finish options. Finish options are separated by a vertical ruled line. Lead finish/Ball material values may wrap to two lines if the finish value exceeds the maximum column width.

Important Information and Disclaimer:The information provided on this page represents TI's knowledge and belief as of the date that it is provided. TI bases its knowledge and belief on information provided by third parties, and makes no representation or warranty as to the accuracy of such information. Efforts are underway to better integrate information from third parties. TI has taken and continues to take reasonable steps to provide representative and accurate information but may not have conducted destructive testing or chemical analysis on incoming materials and chemicals. TI and TI suppliers consider certain information to be proprietary, and thus CAS numbers and other limited information may not be available for release.

In no event shall TI's liability arising out of such information exceed the total purchase price of the TI part(s) at issue in this document sold by TI to Customer on an annual basis.

TAPE AND REEL INFORMATION

QUADRANT ASSIGNMENTS FOR PIN 1 ORIENTATION IN TAPE

*All dimensions are nominal

Device	Package Type	Package Drawing	Pins	SPQ	Reel Diameter (mm)	Reel Width W1 (mm)	A0 (mm)	B0 (mm)	K0 (mm)	P1 (mm)	W (mm)	Pin1 Quadrant
DRV5055A1EDBZRQ1	SOT-23	DBZ	3	3000	180.0	8.4	3.15	2.77	1.22	4.0	8.0	Q3
DRV5055A2EDBZRQ1	SOT-23	DBZ	3	3000	180.0	8.4	3.15	2.77	1.22	4.0	8.0	Q3
DRV5055A3EDBZRQ1	SOT-23	DBZ	3	3000	180.0	8.4	3.15	2.77	1.22	4.0	8.0	Q3
DRV5055A4EDBZRQ1	SOT-23	DBZ	3	3000	180.0	8.4	3.15	2.77	1.22	4.0	8.0	Q3

TAPE AND REEL BOX DIMENSIONS

*All dimensions are nominal

Device	Package Type	Package Drawing	Pins	SPQ	Length (mm)	Width (mm)	Height (mm)
DRV5055A1EDBZRQ1	SOT-23	DBZ	3	3000	213.0	191.0	35.0
DRV5055A2EDBZRQ1	SOT-23	DBZ	3	3000	213.0	191.0	35.0
DRV5055A3EDBZRQ1	SOT-23	DBZ	3	3000	213.0	191.0	35.0
DRV5055A4EDBZRQ1	SOT-23	DBZ	3	3000	213.0	191.0	35.0

GENERIC PACKAGE VIEW

DBZ 3

SOT-23 - 1.12 mm max height

SMALL OUTLINE TRANSISTOR

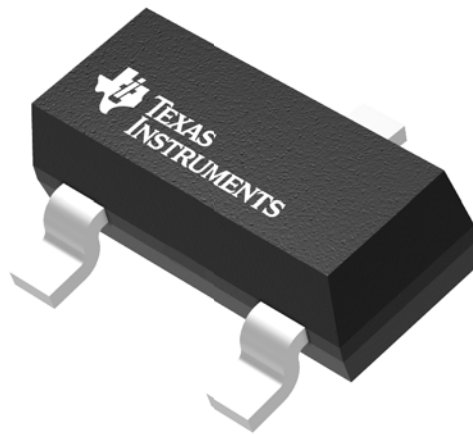

Images above are just a representation of the package family, actual package may vary.
Refer to the product data sheet for package details.

4203227/C

DBZ0003A

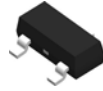

PACKAGE OUTLINE

SOT-23 - 1.12 mm max height

SMALL OUTLINE TRANSISTOR

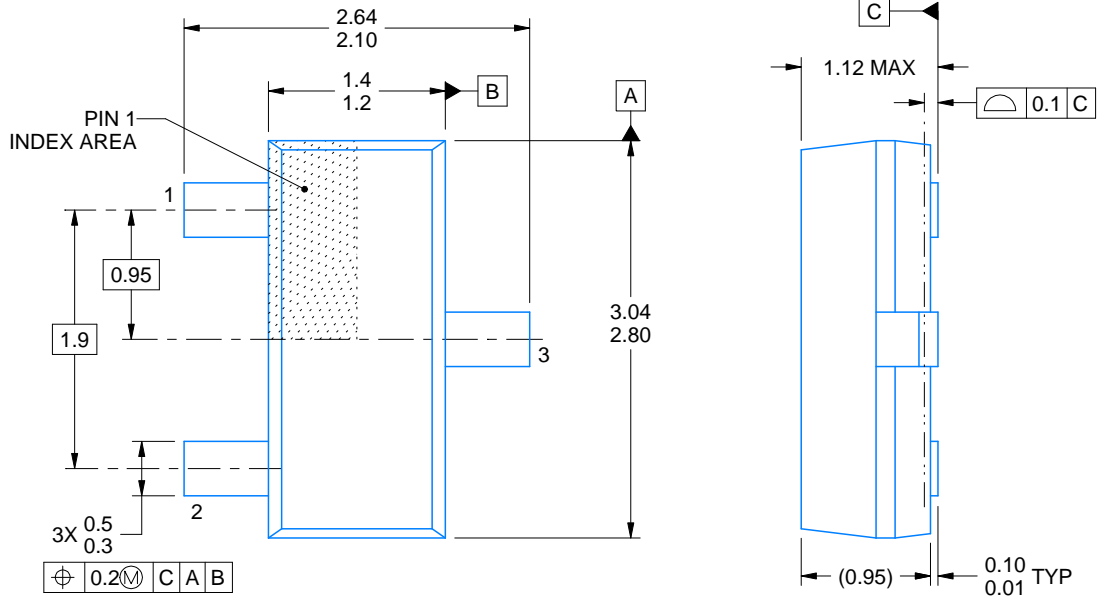

4214838/C 04/2017

NOTES:

1. All linear dimensions are in millimeters. Any dimensions in parenthesis are for reference only. Dimensioning and tolerancing per ASME Y14.5M.
2. This drawing is subject to change without notice.
3. Reference JEDEC registration TO-236, except minimum foot length.

EXAMPLE BOARD LAYOUT

DBZ0003A

SOT-23 - 1.12 mm max height

SMALL OUTLINE TRANSISTOR

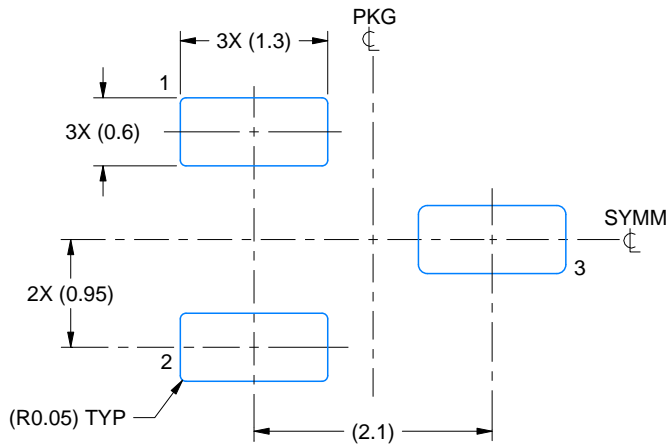

LAND PATTERN EXAMPLE
SCALE:15X

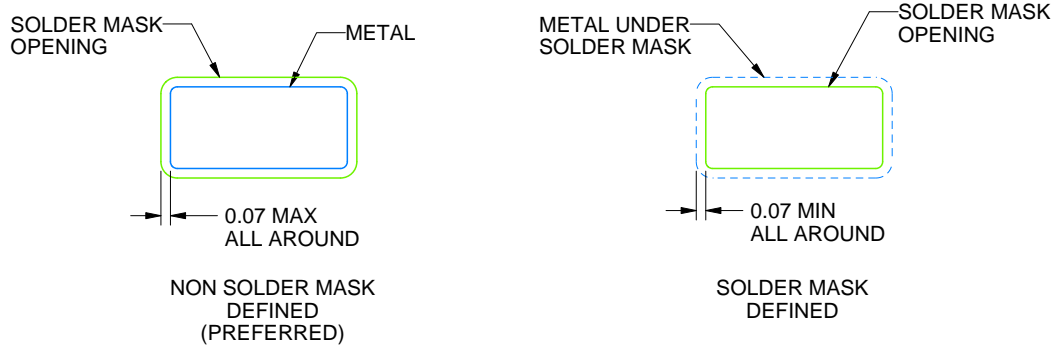

SOLDER MASK DETAILS

4214838/C 04/2017

NOTES: (continued)

4. Publication IPC-7351 may have alternate designs.
5. Solder mask tolerances between and around signal pads can vary based on board fabrication site.

EXAMPLE STENCIL DESIGN

DBZ0003A

SOT-23 - 1.12 mm max height

SMALL OUTLINE TRANSISTOR

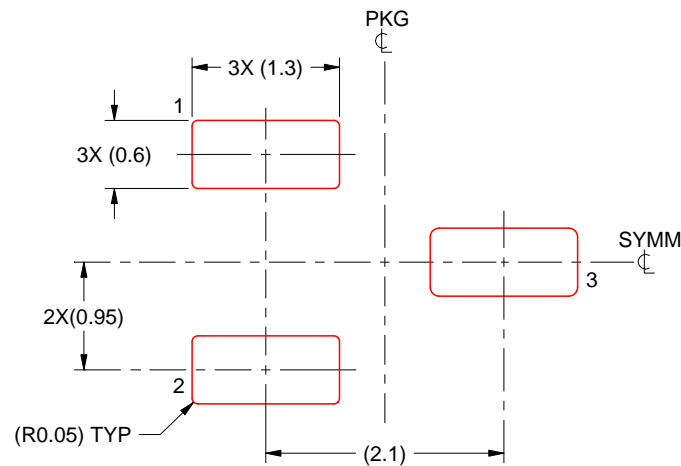

SOLDER PASTE EXAMPLE
BASED ON 0.125 THICK STENCIL
SCALE:15X

4214838/C 04/2017

NOTES: (continued)

6. Laser cutting apertures with trapezoidal walls and rounded corners may offer better paste release. IPC-7525 may have alternate design recommendations.
7. Board assembly site may have different recommendations for stencil design.

LPG0003A



PACKAGE OUTLINE

TO-92 - 5.05 mm max height

TRANSISTOR OUTLINE

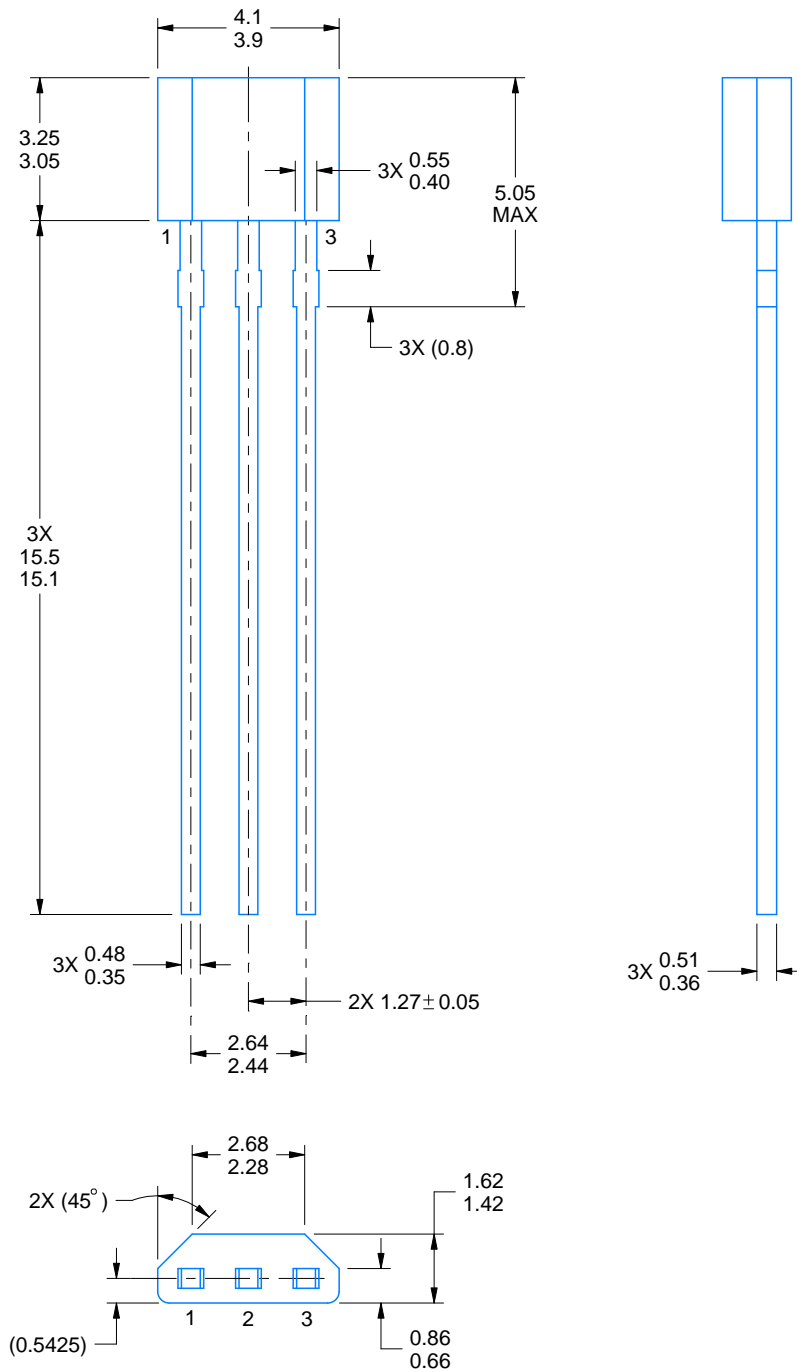

4221343/C 01/2018

NOTES:

1. All linear dimensions are in millimeters. Any dimensions in parenthesis are for reference only. Dimensioning and tolerancing per ASME Y14.5M.
2. This drawing is subject to change without notice.

EXAMPLE BOARD LAYOUT

LPG0003A

TO-92 - 5.05 mm max height

TRANSISTOR OUTLINE

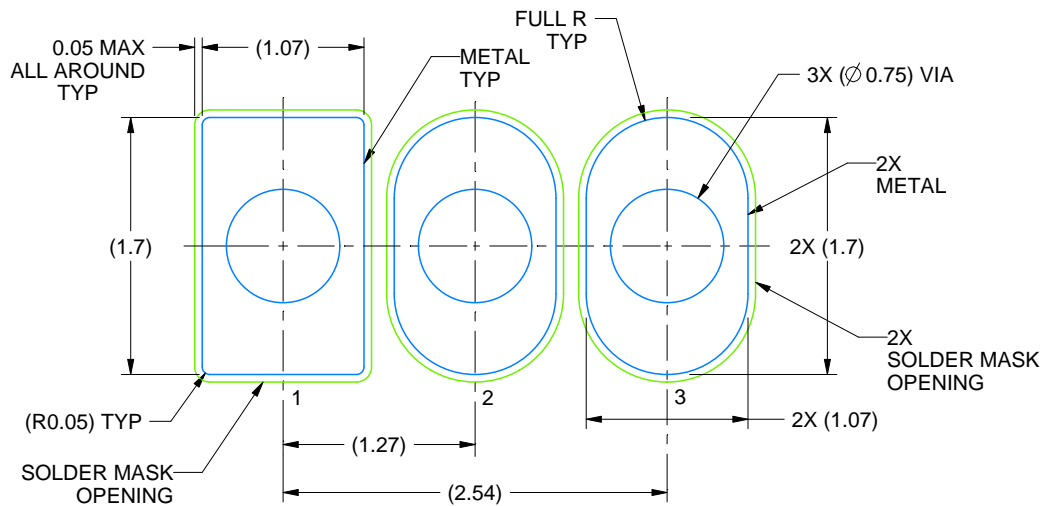

LAND PATTERN EXAMPLE
NON-SOLDER MASK DEFINED
SCALE:20X

4221343/C 01/2018

TAPE SPECIFICATIONS

LPG0003A

TO-92 - 5.05 mm max height

TRANSISTOR OUTLINE

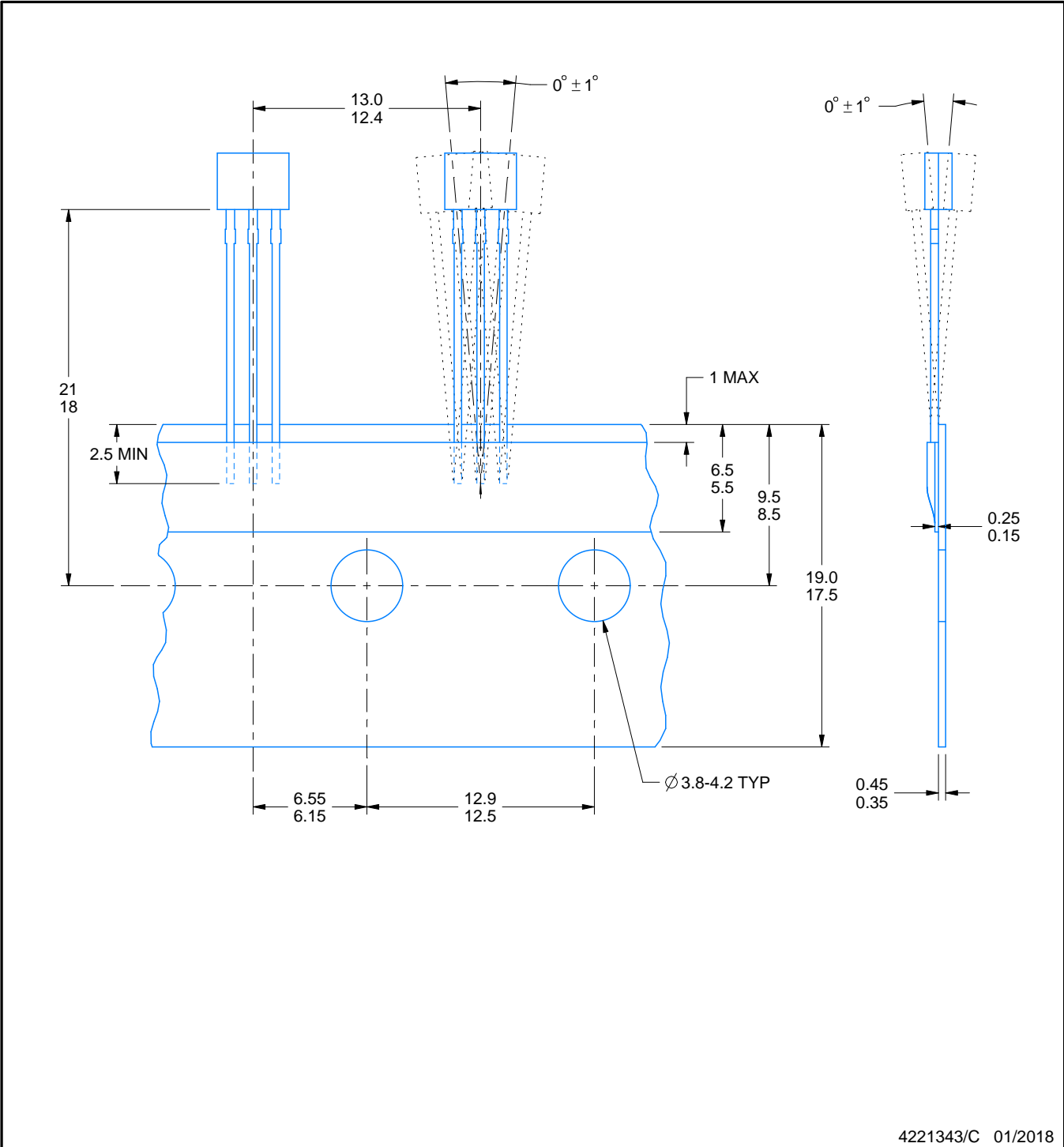

重要声明和免责声明

TI 均以“原样”提供技术性 & 可靠性数据（包括数据表）、设计资源（包括参考设计）、应用或其他设计建议、网络工具、安全信息和其他资源，不保证其中不含任何瑕疵，且不做任何明示或暗示的担保，包括但不限于对适销性、适合某特定用途或不侵犯任何第三方知识产权的暗示担保。

所述资源可供专业开发人员应用 TI 产品进行设计使用。您将对以下行为独自承担全部责任：(1) 针对您的应用选择合适的 TI 产品；(2) 设计、验证并测试您的应用；(3) 确保您的应用满足相应标准以及任何其他安全、安保或其他要求。所述资源如有变更，恕不另行通知。TI 对您使用所述资源的授权仅限于开发资源所涉及 TI 产品的相关应用。除此之外不得复制或展示所述资源，也不提供其它 TI 或任何第三方的知识产权授权许可。如因使用所述资源而产生任何索赔、赔偿、成本、损失及债务等，TI 对此概不负责，并且您须赔偿由此对 TI 及其代表造成的损害。

TI 所提供产品均受 TI 的销售条款 (<http://www.ti.com.cn/zh-cn/legal/termsofsale.html>) 以及 [ti.com.cn](http://www.ti.com.cn) 上或随附 TI 产品提供的其他可适用条款的约束。TI 提供所述资源并不扩展或以其他方式更改 TI 针对 TI 产品所发布的可适用的担保范围或担保免责声明。

邮寄地址：上海市浦东新区世纪大道 1568 号中建大厦 32 楼，邮政编码：200122
Copyright © 2020 德州仪器半导体技术（上海）有限公司

X-ON Electronics

Largest Supplier of Electrical and Electronic Components

Click to view similar products for [Board Mount Hall Effect/Magnetic Sensors](#) category:

Click to view products by [Texas Instruments](#) manufacturer:

Other Similar products are found below :

[HGPRDT005A](#) [AH1894-FA-7](#) [AH277AZ4-AG1](#) [AV-10448](#) [SS41C](#) [AH1894-Z-7](#) [TLE4946-1L](#) [TLE4976L](#) [SS85CA](#) [BU52003GUL-E2](#)
[AH277AZ4-BG1](#) [AH3376-P-B](#) [TLE4941](#) [TLE4945-2L](#) [AH3360-FT4-7](#) [TLE4941-1](#) [AH374-P-A](#) [SS41-JL](#) [AH1913-W-7](#) [AH3373-P-B](#)
[MA732GQ-Z](#) [MA330GQ-Z](#) [S-57K1NBL2A-M3T2U](#) [S-57P1NBL9S-M3T4U](#) [S-576ZNL2B-L3T2U](#) [S-576ZNL2B-A6T8U](#) [S-57P1NBL0S-](#)
[M3T4U](#) [S-57A1NSL1A-M3T2U](#) [S-57K1RBL1A-M3T2U](#) [S-57P1NBH9S-M3T4U](#) [S-57P1NBH0S-M3T4U](#) [S-57A1NSH1A-M3T2U](#) [S-](#)
[57A1NSH2A-M3T2U](#) [S-57K1NBH1A-M3T2U](#) [S-57A1NNL1A-M3T2U](#) [S-5701BC11B-L3T2U5](#) [S-57GNNL3S-A6T8U](#) [S-57TZ1L1S-](#)
[A6T8U](#) [S-57GSNL3S-A6T8U](#) [S-5716ANDH0-I4T1U](#) [S-57GSNL5S-L3T2U](#) [S-57GDNL3S-L3T2U](#) [S-57GNNL3S-L3T2U](#) [S-57RBNL8S-](#)
[L3T2U](#) [S-57RBNL9S-A6T8U](#) [S-57RB1L8S-L3T2U](#) [S-57GDNL5S-L3T2U](#) [S-57RBNL9S-L3T2U](#) [S-57TZ1L1S-L3T2U](#) [S-57TZNL1S-](#)
[A6T8U](#)