

DS26C32AT/DS26C32AM Quad Differential Line Receiver

 Check for Samples: [DS26C32AM](#), [DS26C32AT](#)

FEATURES

- **CMOS Design for Low Power**
- **$\pm 0.2V$ Sensitivity over Input Common Mode Voltage Range**
- **Typical Propagation Delays: 19 ns**
- **Typical Input hysteresis: 60 mV**
- **Inputs Won't Load Line When $V_{CC} = 0V$**
- **Meets the Requirements of EIA Standard RS-422**
- **TRI-STATE Outputs for Connection to System Buses**
- **Available in Surface Mount**
- **Mil-Std-883C Compliant**

DESCRIPTION

The DS26C32A is a quad differential line receiver designed to meet the RS-422, RS-423, and Federal Standards 1020 and 1030 for balanced and unbalanced digital data transmission, while retaining the low power characteristics of CMOS.

The DS26C32A has an input sensitivity of 200 mV over the common mode input voltage range of $\pm 7V$. The DS26C32A features internal pull-up and pull-down resistors which prevent output oscillation on unused channels.

The DS26C32A provides an enable and disable function common to all four receivers. It also features TRI-STATE outputs with 6 mA source and sink capability. This product is pin compatible with the DS26LS32A and the AM26LS32.

Logic Diagram

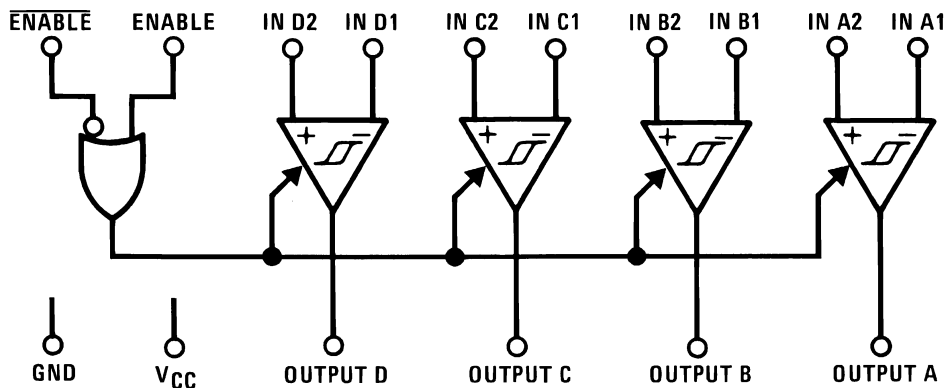

Please be aware that an important notice concerning availability, standard warranty, and use in critical applications of Texas Instruments semiconductor products and disclaimers thereto appears at the end of this data sheet.

All trademarks are the property of their respective owners.

Connection Diagrams

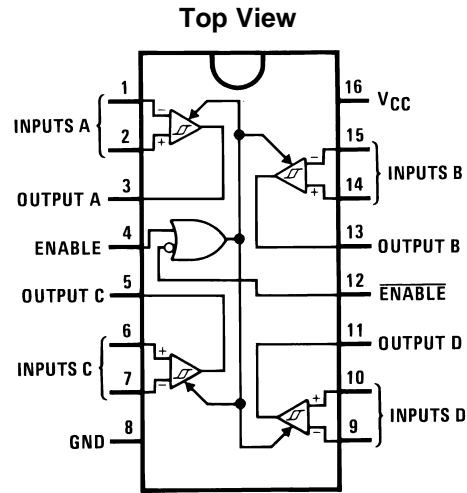

For Complete Military Product Specifications, refer to the appropriate SMD or MDS.

Figure 1. PDIP Package
 See Package Number D0016A or NFG0016E
 See Package Number NAJ0020A, NFE0016A or NAD0016A

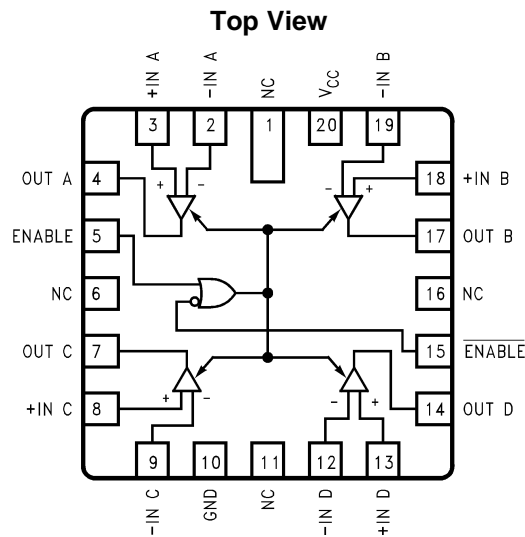

Figure 2. 20-Lead Ceramic Leadless Chip Carrier LCCC Package



These devices have limited built-in ESD protection. The leads should be shorted together or the device placed in conductive foam during storage or handling to prevent electrostatic damage to the MOS gates.

Absolute Maximum Ratings⁽¹⁾⁽²⁾⁽³⁾

Supply Voltage (V_{CC})	7V
Common Mode Range (V_{CM})	$\pm 14V$
Differential Input Voltage (V_{DIFF})	$\pm 14V$
Enable Input Voltage (V_{IN})	7V
Storage Temperature Range (T_{STG})	$-65^{\circ}C$ to $+150^{\circ}C$
Lead Temperature (Soldering 4 sec.)	$260^{\circ}C$
Maximum Power Dissipation at $25^{\circ}C$ ⁽⁴⁾	
Ceramic NFE0016A Package	2308 mW
Plastic NFG0016E Package	1645 mW
SOIC D0016A Package	1190 mW
Ceramic NAJ0020A Package	2108 mW
Ceramic NAD0016A Package	1215 mW
Maximum Current Per Output	± 25 mA
This device does not meet 2000V ESD rating. ⁽⁵⁾	

- (1) Absolute Maximum Ratings are those values beyond which the safety of the device cannot be ensured. They are not meant to imply that the device should be operated at these limits. The table of "Electrical Characteristics" provides conditions for actual device operation.
- (2) Unless otherwise specified, all voltages are referenced to ground.
- (3) If Military/Aerospace specified devices are required, please contact the TI Sales Office/Distributors for availability and specifications
- (4) Ratings apply to ambient temperature at $25^{\circ}C$. Above this temperature derate N Package 13.16 mW/ $^{\circ}C$, J Package 15.38 mW/ $^{\circ}C$, M Package 9.52 mW/ $^{\circ}C$, E Package 12.04 mW/ $^{\circ}C$, and W package 6.94 mW/ $^{\circ}C$.
- (5) ESD Rating: HBM (1.5 k Ω , 100 pF) Inputs $\geq 2000V$ All other pins $\geq 1000V$ EIAJ (0 Ω , 200 pF) $\geq 350V$

Operating Conditions

	Min	Max	Units
Supply Voltage (V_{CC})	4.50	5.50	V
Operating Temperature Range (T_A)			
DS26C32AT	-40	+85	$^{\circ}C$
DS26C32AM	-55	+125	$^{\circ}C$
Enable Input Rise or Fall Times		500	ns

DC Electrical Characteristics
 $V_{CC} = 5V \pm 10\%$ (unless otherwise specified)⁽¹⁾

Parameter		Test Conditions	Min	Typ	Max	Units	
V_{TH}	Minimum Differential Input Voltage	$V_{OUT} = V_{OH}$ or V_{OL} $-7V < V_{CM} < +7V$	-200	35	+200	mV	
R_{IN}	Input Resistance	$V_{IN} = -7V, +7V$ (Other Input = GND)	DS26C32AT	5.0	6.8	10	k Ω
			DS26C32AM	4.5	6.8	11	k Ω
I_{IN}	Input Current	$V_{IN} = +10V,$ Other Input = GND	DS26C32AT	+1.1	+1.5	mA	
			DS26C32AM	+1.1	+1.8	mA	
		$V_{IN} = -10V,$ Other Input = GND	DS26C32AT	-2.0	-2.5	mA	
			DS26C32AM	-2.0	-2.7	mA	
V_{OH}	Minimum High Level Output Voltage	$V_{CC} = \text{Min}, V_{DIFF} = +1V$	3.8	4.2		V	
		$I_{OUT} = -6.0$ mA					
V_{OL}	Maximum Low Level Output Voltage	$V_{CC} = \text{Max}, V_{DIFF} = -1V$		0.2	0.3	V	
		$I_{OUT} = 6.0$ mA					
V_{IH}	Minimum Enable High Input Level Voltage		2.0			V	
V_{IL}	Maximum Enable Low Input Level Voltage				0.8	V	

- (1) Absolute Maximum Ratings are those values beyond which the safety of the device cannot be ensured. They are not meant to imply that the device should be operated at these limits. The table of "Electrical Characteristics" provides conditions for actual device operation.

DC Electrical Characteristics (continued) $V_{CC} = 5V \pm 10\%$ (unless otherwise specified)⁽¹⁾

Parameter		Test Conditions	Min	Typ	Max	Units
I_{OZ}	Maximum TRI-STATE Output Leakage Current	$V_{OUT} = V_{CC}$ or GND, $\overline{ENABLE} = V_{IL}$, $ENABLE = V_{IH}$		± 0.5	± 5.0	μA
I_I	Maximum Enable Input Current	$V_{IN} = V_{CC}$ or GND			± 1.0	μA
I_{CC}	Quiescent Power Supply Current	$V_{CC} = \text{Max}$,	DS26C32AT	16	23	mA
		$V_{DIF} = +1V$	DS26C32AM	16	25	mA
V_{HYST}	Input Hysteresis	$V_{CM} = 0V$		60		mV

AC Electrical Characteristics $V_{CC} = 5V \pm 10\%$ ⁽¹⁾

Parameter	Test Conditions	Min	Typ	Max		Units	
				DS26C32AT	DS26C32AM		
t_{PLH} , t_{PHL}	Propagation Delay Input to Output	$C_L = 50 \text{ pF}$	10	19	30	35	ns
		$V_{DIFF} = 2.5V$					
		$V_{CM} = 0V$					
t_{RISE} , t_{FALL}	Output Rise and Fall Times	$C_L = 50 \text{ pF}$		4	9	9	ns
		$V_{DIFF} = 2.5V$					
		$V_{CM} = 0V$					
t_{PLZ} , t_{PHZ}	Propagation Delay ENABLE to Output	$C_L = 50 \text{ pF}$		13	22	29	ns
		$R_L = 1000\Omega$					
		$V_{DIFF} = 2.5V$					
t_{PZL} , t_{PZH}	Propagation Delay ENABLE to Output	$C_L = 50 \text{ pF}$		13	23	29	ns
		$R_L = 1000\Omega$					
		$V_{DIFF} = 2.5V$					

(1) Unless otherwise specified, Min/Max limits apply over recommended operating conditions. All typicals are given for $V_{CC} = 5V$ and $T_A = 25^\circ C$.

Comparison Table of Switching Characteristics into “LS-Type” Load(Figure 6, Figure 7, and Figure 8) ⁽¹⁾

Parameter	Test Conditions	DS26C32A	DS26LS32A	Units	
		Typ	Typ		
t_{PLH}	Input to Output	$C_L = 15 \text{ pF}$	17	23	ns
t_{PHL}			19	23	ns
t_{LZ}	ENABLE to Output	$C_L = 5 \text{ pF}$	13	15	ns
t_{HZ}			12	20	ns
t_{ZL}	ENABLE to Output	$C_L = 15 \text{ pF}$	13	14	ns
t_{ZH}			13	15	ns

(1) This table is provided for comparison purposes only. The values in this table for the DS26C32A reflect the performance of the device, but are not tested.

TEST AND SWITCHING WAVEFORMS

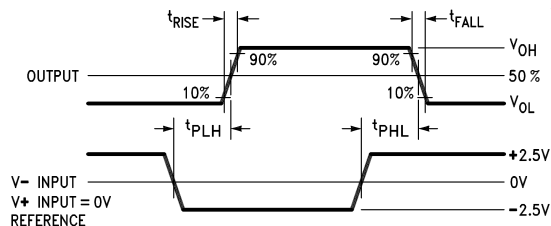
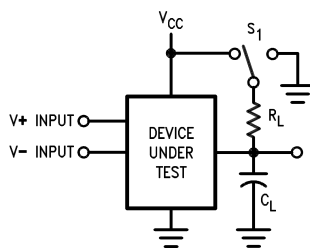

Figure 3. Propagation Delay



C_L includes load and test jig capacitance.
 $S_1 = V_{CC}$ for t_{PZL} and t_{PLZ} measurements.
 $S_1 = Gnd$ for t_{PZH} and t_{PHZ} measurements.

Figure 4. Test Circuit for TRI-STATE Output Tests

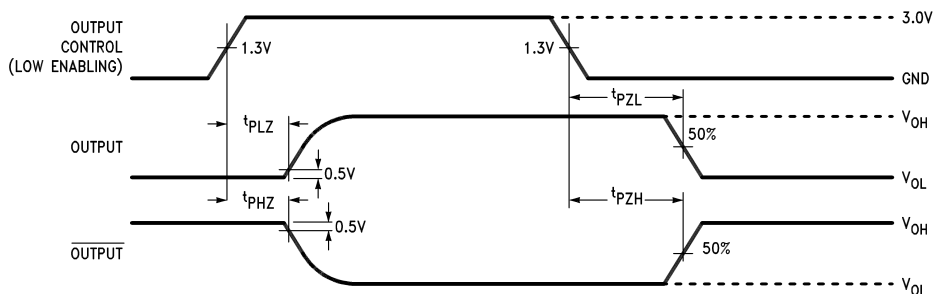

Figure 5. TRI-STATE Output Enable and Disable Waveforms

AC Test Circuit and Switching Time Waveforms

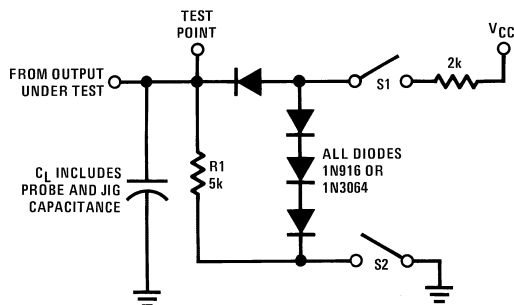

Figure 6. Load Test Circuit for TRI-STATE Outputs for "LS-Type" Load

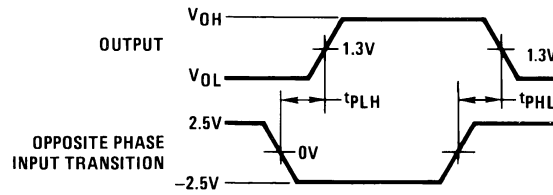
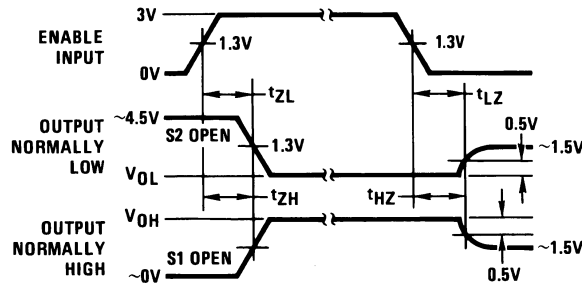

Figure 7. Propagation Delay for “LS-Type” Load



- (1) Diagram shown for $\overline{\text{ENABLE}}$ low.
- (2) S1 and S2 of load circuit are closed except where shown.
- (3) Pulse generator for all pulses: Rate \leq 1.0 MHz; $Z_0 = 50\Omega$; $t_r \leq 15$ ns; $t_f \leq 6.0$ ns.

Figure 8. Enable and Disable Times for “LS-Type” Load

Truth Table⁽¹⁾

ENABLE	$\overline{\text{ENABLE}}$	Input	Output
L	H	X	Z
All Other Combinations of Enable Inputs		$V_{ID} \geq V_{TH} (\text{Max})$	H
		$V_{ID} \leq V_{TH} (\text{Min})$	L
		Open	H

(1) Z = TRI-STATE

TYPICAL APPLICATIONS

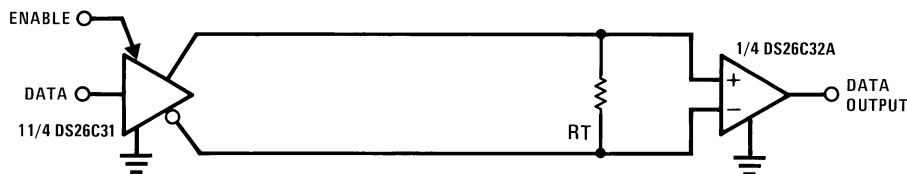

Figure 9. Two-Wire Balanced Systems, RS-422

Typical Performance Characteristics

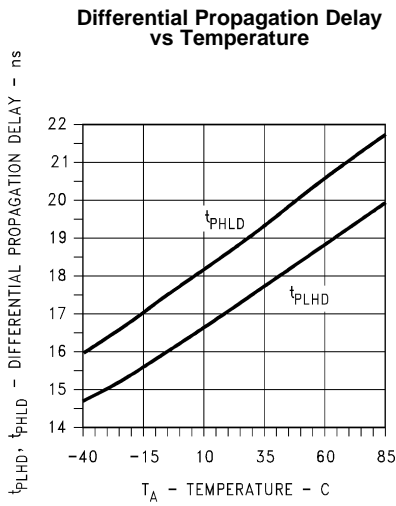

Figure 10.

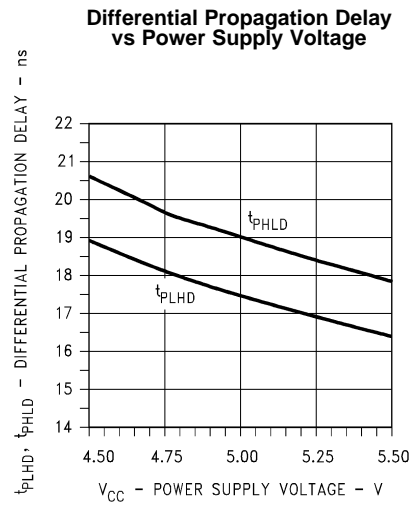

Figure 11.

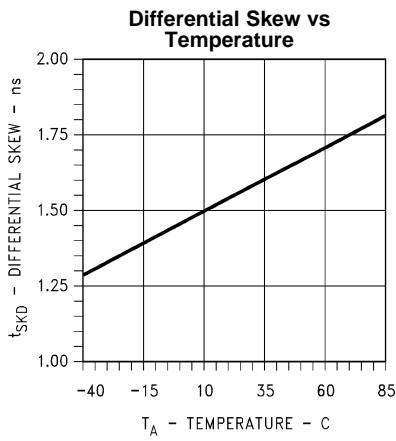

Figure 12.

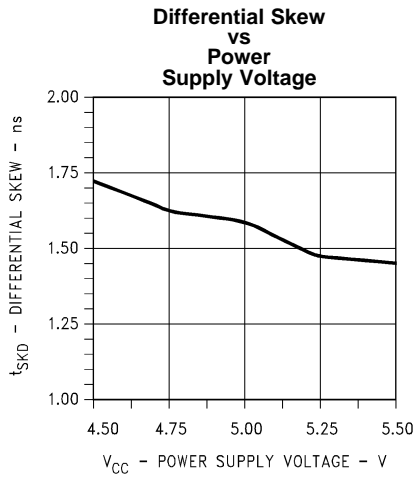

Figure 13.

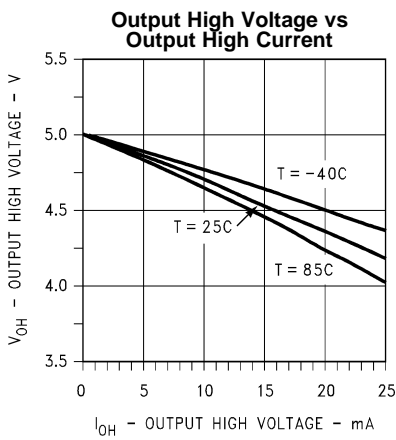

Figure 14.

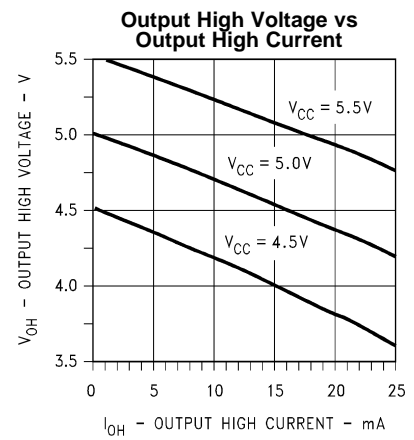

Figure 15.

Typical Performance Characteristics (continued)

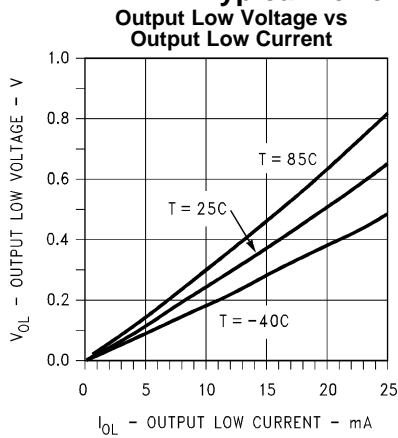

Figure 16.

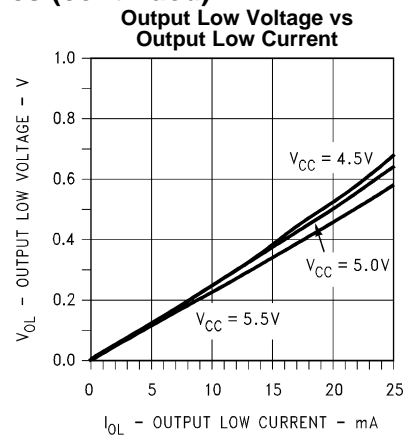

Figure 17.

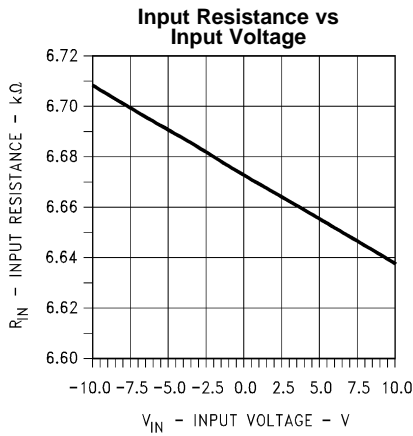

Figure 18.

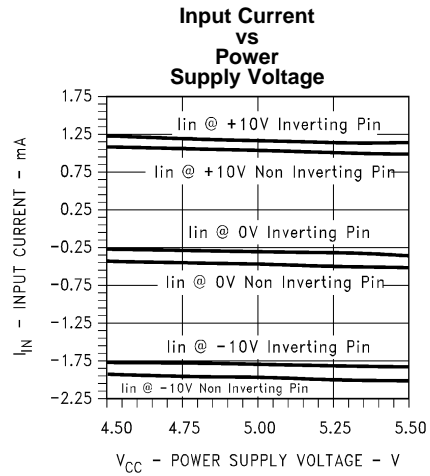

Figure 19.

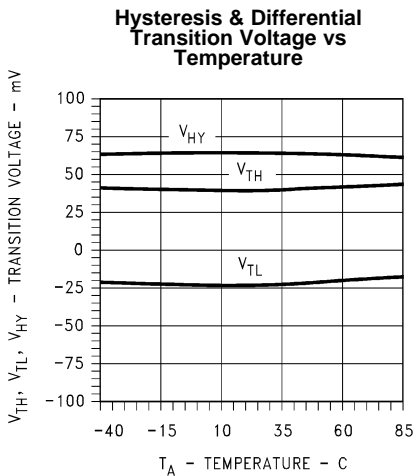

Figure 20.

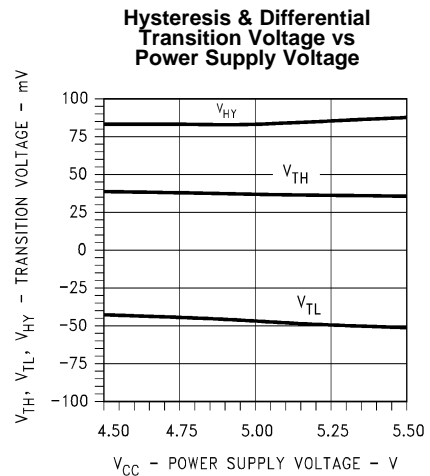

Figure 21.

Typical Performance Characteristics (continued)

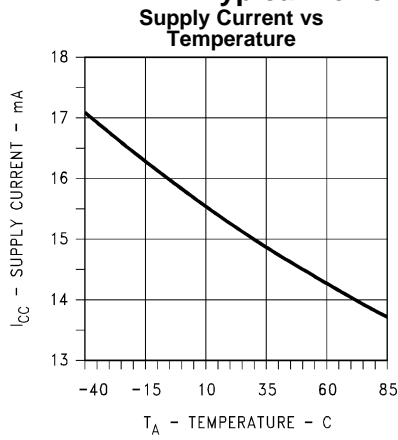

Figure 22.

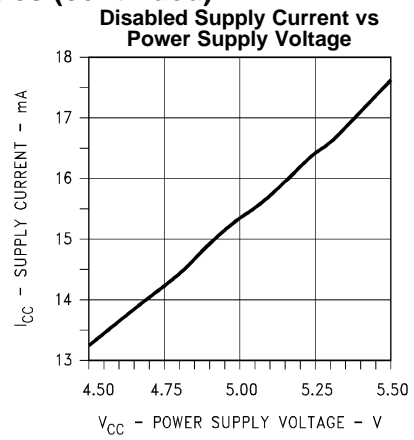

Figure 23.

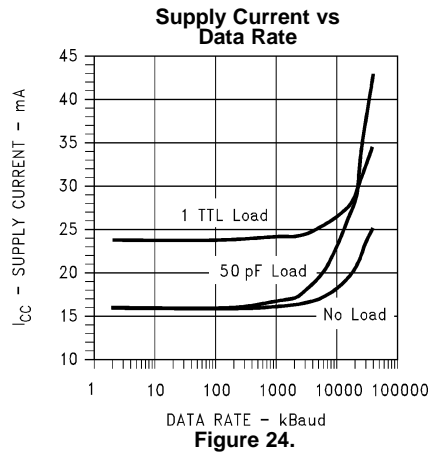



Figure 24.

REVISION HISTORY

Changes from Revision B (April 2013) to Revision C	Page
• Changed layout of National Data Sheet to TI format	9

PACKAGING INFORMATION

Orderable Device	Status (1)	Package Type	Package Drawing	Pins	Package Qty	Eco Plan (2)	Lead/Ball Finish (6)	MSL Peak Temp (3)	Op Temp (°C)	Device Marking (4/5)	Samples
DS26C32ATM	LIFEBUY	SOIC	D	16	48	TBD	Call TI	Call TI	-40 to 85	DS26C32ATM	
DS26C32ATM/NOPB	ACTIVE	SOIC	D	16	48	Green (RoHS & no Sb/Br)	CU SN	Level-1-260C-UNLIM	-40 to 85	DS26C32ATM	
DS26C32ATMX	LIFEBUY	SOIC	D	16	2500	TBD	Call TI	Call TI	-40 to 85	DS26C32ATM	
DS26C32ATMX/NOPB	ACTIVE	SOIC	D	16	2500	Green (RoHS & no Sb/Br)	CU SN	Level-1-260C-UNLIM	-40 to 85	DS26C32ATM	

(1) The marketing status values are defined as follows:

ACTIVE: Product device recommended for new designs.

LIFEBUY: TI has announced that the device will be discontinued, and a lifetime-buy period is in effect.

NRND: Not recommended for new designs. Device is in production to support existing customers, but TI does not recommend using this part in a new design.

PREVIEW: Device has been announced but is not in production. Samples may or may not be available.

OBSELETE: TI has discontinued the production of the device.

(2) **RoHS:** TI defines "RoHS" to mean semiconductor products that are compliant with the current EU RoHS requirements for all 10 RoHS substances, including the requirement that RoHS substance do not exceed 0.1% by weight in homogeneous materials. Where designed to be soldered at high temperatures, "RoHS" products are suitable for use in specified lead-free processes. TI may reference these types of products as "Pb-Free".

RoHS Exempt: TI defines "RoHS Exempt" to mean products that contain lead but are compliant with EU RoHS pursuant to a specific EU RoHS exemption.

Green: TI defines "Green" to mean the content of Chlorine (Cl) and Bromine (Br) based flame retardants meet JS709B low halogen requirements of <=1000ppm threshold. Antimony trioxide based flame retardants must also meet the <=1000ppm threshold requirement.

(3) MSL, Peak Temp. - The Moisture Sensitivity Level rating according to the JEDEC industry standard classifications, and peak solder temperature.

(4) There may be additional marking, which relates to the logo, the lot trace code information, or the environmental category on the device.

(5) Multiple Device Markings will be inside parentheses. Only one Device Marking contained in parentheses and separated by a "~" will appear on a device. If a line is indented then it is a continuation of the previous line and the two combined represent the entire Device Marking for that device.

(6) Lead/Ball Finish - Orderable Devices may have multiple material finish options. Finish options are separated by a vertical ruled line. Lead/Ball Finish values may wrap to two lines if the finish value exceeds the maximum column width.

Important Information and Disclaimer:The information provided on this page represents TI's knowledge and belief as of the date that it is provided. TI bases its knowledge and belief on information provided by third parties, and makes no representation or warranty as to the accuracy of such information. Efforts are underway to better integrate information from third parties. TI has taken and continues to take reasonable steps to provide representative and accurate information but may not have conducted destructive testing or chemical analysis on incoming materials and chemicals. TI and TI suppliers consider certain information to be proprietary, and thus CAS numbers and other limited information may not be available for release.

In no event shall TI's liability arising out of such information exceed the total purchase price of the TI part(s) at issue in this document sold by TI to Customer on an annual basis.

TAPE AND REEL INFORMATION

QUADRANT ASSIGNMENTS FOR PIN 1 ORIENTATION IN TAPE

*All dimensions are nominal

Device	Package Type	Package Drawing	Pins	SPQ	Reel Diameter (mm)	Reel Width W1 (mm)	A0 (mm)	B0 (mm)	K0 (mm)	P1 (mm)	W (mm)	Pin1 Quadrant
DS26C32ATMX	SOIC	D	16	2500	330.0	16.4	6.5	10.3	2.3	8.0	16.0	Q1
DS26C32ATMX/NOPB	SOIC	D	16	2500	330.0	16.4	6.5	10.3	2.3	8.0	16.0	Q1

TAPE AND REEL BOX DIMENSIONS

*All dimensions are nominal

Device	Package Type	Package Drawing	Pins	SPQ	Length (mm)	Width (mm)	Height (mm)
DS26C32ATMX	SOIC	D	16	2500	367.0	367.0	35.0
DS26C32ATMX/NOPB	SOIC	D	16	2500	367.0	367.0	35.0

D (R-PDSO-G16)

PLASTIC SMALL OUTLINE



- NOTES:
- A. All linear dimensions are in inches (millimeters).
 - B. This drawing is subject to change without notice.
 - C. Body length does not include mold flash, protrusions, or gate burrs. Mold flash, protrusions, or gate burrs shall not exceed 0.006 (0,15) each side.
 - D. Body width does not include interlead flash. Interlead flash shall not exceed 0.017 (0,43) each side.
 - E. Reference JEDEC MS-012 variation AC.

IMPORTANT NOTICE

Texas Instruments Incorporated (TI) reserves the right to make corrections, enhancements, improvements and other changes to its semiconductor products and services per JESD46, latest issue, and to discontinue any product or service per JESD48, latest issue. Buyers should obtain the latest relevant information before placing orders and should verify that such information is current and complete.

TI's published terms of sale for semiconductor products (<http://www.ti.com/sc/docs/stdterms.htm>) apply to the sale of packaged integrated circuit products that TI has qualified and released to market. Additional terms may apply to the use or sale of other types of TI products and services.

Reproduction of significant portions of TI information in TI data sheets is permissible only if reproduction is without alteration and is accompanied by all associated warranties, conditions, limitations, and notices. TI is not responsible or liable for such reproduced documentation. Information of third parties may be subject to additional restrictions. Resale of TI products or services with statements different from or beyond the parameters stated by TI for that product or service voids all express and any implied warranties for the associated TI product or service and is an unfair and deceptive business practice. TI is not responsible or liable for any such statements.

Buyers and others who are developing systems that incorporate TI products (collectively, "Designers") understand and agree that Designers remain responsible for using their independent analysis, evaluation and judgment in designing their applications and that Designers have full and exclusive responsibility to assure the safety of Designers' applications and compliance of their applications (and of all TI products used in or for Designers' applications) with all applicable regulations, laws and other applicable requirements. Designer represents that, with respect to their applications, Designer has all the necessary expertise to create and implement safeguards that (1) anticipate dangerous consequences of failures, (2) monitor failures and their consequences, and (3) lessen the likelihood of failures that might cause harm and take appropriate actions. Designer agrees that prior to using or distributing any applications that include TI products, Designer will thoroughly test such applications and the functionality of such TI products as used in such applications.

TI's provision of technical, application or other design advice, quality characterization, reliability data or other services or information, including, but not limited to, reference designs and materials relating to evaluation modules, (collectively, "TI Resources") are intended to assist designers who are developing applications that incorporate TI products; by downloading, accessing or using TI Resources in any way, Designer (individually or, if Designer is acting on behalf of a company, Designer's company) agrees to use any particular TI Resource solely for this purpose and subject to the terms of this Notice.

TI's provision of TI Resources does not expand or otherwise alter TI's applicable published warranties or warranty disclaimers for TI products, and no additional obligations or liabilities arise from TI providing such TI Resources. TI reserves the right to make corrections, enhancements, improvements and other changes to its TI Resources. TI has not conducted any testing other than that specifically described in the published documentation for a particular TI Resource.

Designer is authorized to use, copy and modify any individual TI Resource only in connection with the development of applications that include the TI product(s) identified in such TI Resource. NO OTHER LICENSE, EXPRESS OR IMPLIED, BY ESTOPPEL OR OTHERWISE TO ANY OTHER TI INTELLECTUAL PROPERTY RIGHT, AND NO LICENSE TO ANY TECHNOLOGY OR INTELLECTUAL PROPERTY RIGHT OF TI OR ANY THIRD PARTY IS GRANTED HEREIN, including but not limited to any patent right, copyright, mask work right, or other intellectual property right relating to any combination, machine, or process in which TI products or services are used. Information regarding or referencing third-party products or services does not constitute a license to use such products or services, or a warranty or endorsement thereof. Use of TI Resources may require a license from a third party under the patents or other intellectual property of the third party, or a license from TI under the patents or other intellectual property of TI.

TI RESOURCES ARE PROVIDED "AS IS" AND WITH ALL FAULTS. TI DISCLAIMS ALL OTHER WARRANTIES OR REPRESENTATIONS, EXPRESS OR IMPLIED, REGARDING RESOURCES OR USE THEREOF, INCLUDING BUT NOT LIMITED TO ACCURACY OR COMPLETENESS, TITLE, ANY EPIDEMIC FAILURE WARRANTY AND ANY IMPLIED WARRANTIES OF MERCHANTABILITY, FITNESS FOR A PARTICULAR PURPOSE, AND NON-INFRINGEMENT OF ANY THIRD PARTY INTELLECTUAL PROPERTY RIGHTS. TI SHALL NOT BE LIABLE FOR AND SHALL NOT DEFEND OR INDEMNIFY DESIGNER AGAINST ANY CLAIM, INCLUDING BUT NOT LIMITED TO ANY INFRINGEMENT CLAIM THAT RELATES TO OR IS BASED ON ANY COMBINATION OF PRODUCTS EVEN IF DESCRIBED IN TI RESOURCES OR OTHERWISE. IN NO EVENT SHALL TI BE LIABLE FOR ANY ACTUAL, DIRECT, SPECIAL, COLLATERAL, INDIRECT, PUNITIVE, INCIDENTAL, CONSEQUENTIAL OR EXEMPLARY DAMAGES IN CONNECTION WITH OR ARISING OUT OF TI RESOURCES OR USE THEREOF, AND REGARDLESS OF WHETHER TI HAS BEEN ADVISED OF THE POSSIBILITY OF SUCH DAMAGES.

Unless TI has explicitly designated an individual product as meeting the requirements of a particular industry standard (e.g., ISO/TS 16949 and ISO 26262), TI is not responsible for any failure to meet such industry standard requirements.

Where TI specifically promotes products as facilitating functional safety or as compliant with industry functional safety standards, such products are intended to help enable customers to design and create their own applications that meet applicable functional safety standards and requirements. Using products in an application does not by itself establish any safety features in the application. Designers must ensure compliance with safety-related requirements and standards applicable to their applications. Designer may not use any TI products in life-critical medical equipment unless authorized officers of the parties have executed a special contract specifically governing such use. Life-critical medical equipment is medical equipment where failure of such equipment would cause serious bodily injury or death (e.g., life support, pacemakers, defibrillators, heart pumps, neurostimulators, and implantables). Such equipment includes, without limitation, all medical devices identified by the U.S. Food and Drug Administration as Class III devices and equivalent classifications outside the U.S.

TI may expressly designate certain products as completing a particular qualification (e.g., Q100, Military Grade, or Enhanced Product). Designers agree that it has the necessary expertise to select the product with the appropriate qualification designation for their applications and that proper product selection is at Designers' own risk. Designers are solely responsible for compliance with all legal and regulatory requirements in connection with such selection.

Designer will fully indemnify TI and its representatives against any damages, costs, losses, and/or liabilities arising out of Designer's non-compliance with the terms and provisions of this Notice.

X-ON Electronics

Largest Supplier of Electrical and Electronic Components

Click to view similar products for [RS-422 Interface IC category](#):

Click to view products by [Texas Instruments manufacturer](#):

Other Similar products are found below :

[DS3486N](#) [DS9637ACN](#) [MAX3032EESE+T](#) [AM26C32IDR](#) [SN65C1168PW](#) [ISL32172EFBZ](#) [ISL32172EIBZ](#) [ISL32172EIBZ-T](#)
[ISL32179EFRZ](#) [ISL32179EIRZ](#) [SP26LV432CN-L](#) [MC26LS30D](#) [AM26C31CN](#) [DS26C31TN](#) [AM26C31INE4](#) [AM26C32CNE4](#)
[SN75ALS193NE4](#) [AM26C31CN](#) [ISL32174EFVZ](#) [MAX3030EEUE+T](#) [ISL32172EFVZ](#) [ISL32174EFVZ-T](#) [ISL32172EFVZ-T](#)
[ISL32272EFVZ-T](#) [ISL32179EIRZ-T](#) [AM26LS32AIDRG4](#) [AM26LV32EIDRG4](#) [AM26C31CDRE4](#) [AM26C31IDRG4](#) [MC3487DE4](#)
[AM26C32QDR](#) [AM26LV32INSG4](#) [AM26LV32CNSRG4](#) [AM26LS32ACNSRG4](#) [AM26C31CD](#) [AM26C31CDBR](#) [AM26C31CNSR](#)
[AM26C31IDBR](#) [AM26C31IDR](#) [AM26C31IDRE4](#) [AM26C31INSR](#) [AM26C31IPWR](#) [AM26C31IPWRG4](#) [AM26C31MDREP](#)
[AM26C31QDG4](#) [AM26C31QDR](#) [AM26C31QDRG4](#) [AM26C32CD](#) [AM26C32CDR](#) [AM26C32CN](#)