

INA188

精密零漂移、轨到轨输出、高压仪表放大器

1 特性

- 出色的直流性能：
 - 低输入偏移电压：55 μ V（最大值）
 - 低输入偏移漂移：0.2 μ V/ $^{\circ}$ C（最大值）
 - 高共模抑制比 (CMRR)：104dB，增益 \geq 10（最小值）
- 低输入噪声：
 - 1kHz 时为 12nV/ $\sqrt{\text{Hz}}$
 - 0.25 μ V_{PP} (0.1Hz 至 10Hz)
- 宽电源范围：
 - 单电源：4V 至 36V
 - 双电源： \pm 2V 至 \pm 18V
- 通过单个外部电阻设置增益：
 - 增益公式： $G = 1 + (50\text{k}\Omega / R_G)$
 - 增益误差：0.007%， $G = 1$
 - 增益漂移：5ppm/ $^{\circ}$ C（最大值）， $G = 1$
- 输入电压： $(V-) + 0.1\text{V}$ 至 $(V+) - 1.5\text{V}$
- 已过滤射频干扰 (RFI) 的输入
- 轨到轨输出
- 低静态电流：1.4mA
- 工作温度范围： -55°C 至 $+150^{\circ}\text{C}$
- 小外形尺寸集成电路 (SOIC)-8 和双边扁平无引线 (DFN)-8 封装

2 应用范围

- 桥式放大器
- 心电图 (ECG) 放大器
- 压力传感器
- 医疗仪表
- 便携式仪表
- 衡器
- 热电偶放大器
- 电阻式温度检测器 (RTD) 传感器放大器
- 数据采集

3 说明

INA188 是一款精密的仪表放大器，其采用德州仪器 (TI) 专有的自动归零技术，可实现低偏移电压、近零偏移和增益漂移、出色的线性度以及向下扩展至直流的超低噪声密度 (12nV/ $\sqrt{\text{Hz}}$)。

INA188 经优化可提供超过 104dB 的出色共模抑制比 ($G \geq 10$)。出色的共模和电源抑制性能可为高分辨率的精密测量应用提供支持。这种通用型三运放设计可提供轨到轨输出、由 4V 单电源或高达 \pm 18V 的双电源供电的低电压运行以及一个高阻抗的宽输入范围。这些规范值使得该器件成为通用信号测量和传感器调节应用（如温度或桥式应用）的理想选择。

可通过单个外部电阻在 1 到 1000 范围内设置增益。

INA188 设计为采用符合行业标准的增益公式： $G = 1 + (50\text{k}\Omega / R_G)$ 。基准引脚可用于单电源运行过程中的电平转换或者用于偏移校准。

INA188 的额定运行温度范围为 -40°C 至 $+125^{\circ}\text{C}$ 。

器件信息

订货编号	封装	封装尺寸
INA188	SOIC (8)	4.90mm x 3.91mm
INA188	WSON (8) ⁽²⁾	4.00mm x 4.00mm

(1) 要了解所有可用封装，请见数据表末尾的可订购产品附录。

(2) DRJ 封装 (WSON-8) 是一款预览器件。

简化电路原理图

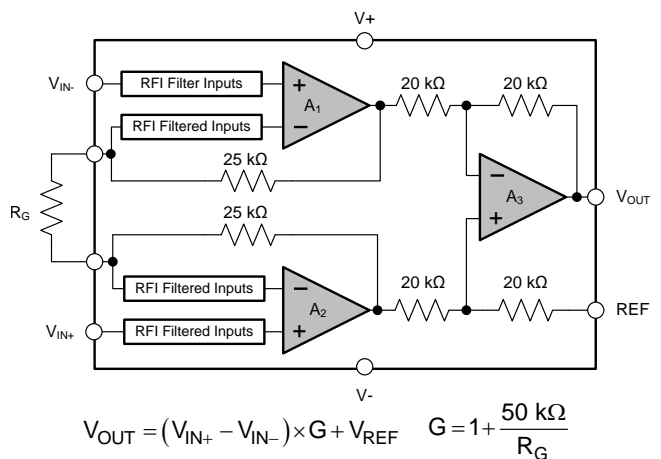

目录

1	特性	1	7.3	Feature Description	18
2	应用范围	1	7.4	Device Functional Modes	21
3	说明	1	8	Application and Implementation	27
4	修订历史记录	2	8.1	Application Information	27
5	Pin Configuration and Functions	3	8.2	Typical Application	27
6	Specifications	4	9	Power Supply Recommendations	29
6.1	Absolute Maximum Ratings	4	10	Layout	29
6.2	ESD Ratings	4	10.1	Layout Guidelines	29
6.3	Recommended Operating Conditions	4	10.2	Layout Example	30
6.4	Thermal Information	4	11	器件和文档支持	31
6.5	Electrical Characteristics: $V_S = \pm 4\text{ V to } \pm 18\text{ V}$ ($V_S = 8\text{ V to } 36\text{ V}$)	5	11.1	器件支持	31
6.6	Electrical Characteristics: $V_S = \pm 2\text{ V to } < \pm 4\text{ V}$ ($V_S = 4\text{ V to } < 8\text{ V}$)	7	11.2	文档支持	31
6.7	Typical Characteristics	9	11.3	社区资源	31
7	Detailed Description	17	11.4	商标	31
7.1	Overview	17	11.5	静电放电警告	31
7.2	Functional Block Diagram	17	11.6	Glossary	31
			12	机械、封装和可订购信息	32

4 修订历史记录

日期	修订版本	注释
2015 年 9 月	*	最初发布。

5 Pin Configuration and Functions

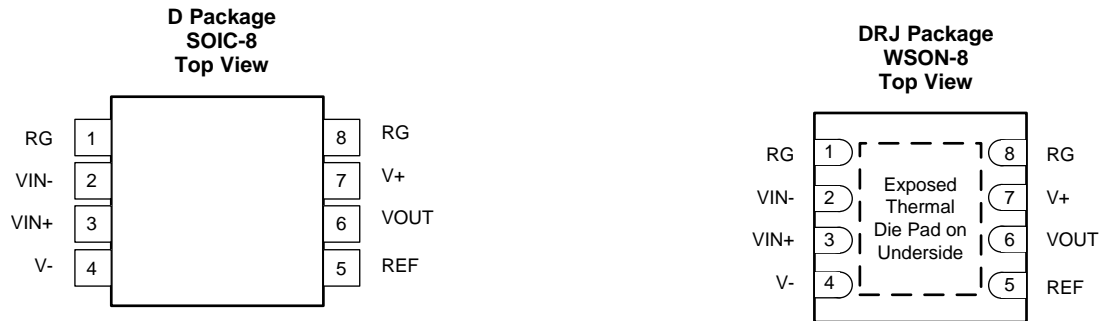

Pin Functions

PIN		I/O	DESCRIPTION
NO.	NAME		
REF	5	I	Reference input. This pin must be driven by low impedance or connected to ground.
RG	1, 8	—	Gain setting pin. For gains greater than 1, place a gain resistor between pin 1 and pin 8.
V-	4	—	Negative supply
V+	7	—	Positive supply
VIN-	2	I	Negative input
VIN+	3	I	Positive input
VOUT	6	O	Output

6 Specifications

6.1 Absolute Maximum Ratings

 over operating free-air temperature range (unless otherwise noted)⁽¹⁾

		MIN	MAX	UNIT
Voltage	Supply	±20		V
		40 (single supply)		
	Current	±10		mA
	Analog input range ⁽²⁾	(V-) – 0.5	(V+) + 0.5	V
Output short-circuit ⁽³⁾		Continuous		
Temperature	Operating range, T _A	–55	150	°C
	Junction, T _J		150	
	Storage temperature, T _{stg}	–65	150	

- (1) Stresses beyond those listed under *Absolute Maximum Ratings* may cause permanent damage to the device. These are stress ratings only, which do not imply functional operation of the device at these or any other conditions beyond those indicated under *Recommended Operating Conditions*. Exposure to absolute-maximum-rated conditions for extended periods may affect device reliability.
- (2) Input pins are diode-clamped to the power-supply rails. Input signals that can swing more than 0.3 V beyond the supply rails must be current limited to 10 mA or less.
- (3) Short-circuit to ground.

6.2 ESD Ratings

		VALUE	UNIT
V _(ESD)	Electrostatic discharge	Human-body model (HBM), per ANSI/ESDA/JEDEC JS-001 ⁽¹⁾	±2500
		Charged-device model (CDM), per JEDEC specification JESD22-C101 ⁽²⁾	±1000

- (1) JEDEC document JEP155 states that 500-V HBM allows safe manufacturing with a standard ESD control process.
- (2) JEDEC document JEP157 states that 250-V CDM allows safe manufacturing with a standard ESD control process.

6.3 Recommended Operating Conditions

over operating free-air temperature range (unless otherwise noted)

		MIN	NOM	MAX	UNIT
V _S	Supply voltage	4 (±2)		36 (±18)	V
	Specified temperature	–40		125	°C

6.4 Thermal Information

THERMAL METRIC ⁽¹⁾		INA188		UNIT
		D (SOIC)	DRG (WSON)	
		8 PINS	8 PINS	
R _{θJA}	Junction-to-ambient thermal resistance	125	145	°C/W
R _{θJC(top)}	Junction-to-case (top) thermal resistance	80	75	°C/W
R _{θJB}	Junction-to-board thermal resistance	68	39	°C/W
Ψ _{JT}	Junction-to-top characterization parameter	32	14	°C/W
Ψ _{JB}	Junction-to-board characterization parameter	68	105	°C/W
R _{θJC(bot)}	Junction-to-case (bottom) thermal resistance	N/A	N/A	°C/W

- (1) For more information about traditional and new thermal metrics, see the *IC Package Thermal Metrics* application report, [SPRA953](#).

6.5 Electrical Characteristics: $V_S = \pm 4\text{ V}$ to $\pm 18\text{ V}$ ($V_S = 8\text{ V}$ to 36 V)

At $T_A = 25^\circ\text{C}$, $R_L = 10\text{ k}\Omega$, $V_{REF} = V_S / 2$, and $G = 1$, unless otherwise noted.

PARAMETER		TEST CONDITIONS	MIN	TYP	MAX	UNIT
INPUT⁽¹⁾						
V_{OSI}	Input stage offset voltage	At RTI ⁽²⁾		± 25	± 55	μV
		At RTI, $T_A = -40^\circ\text{C}$ to $+125^\circ\text{C}$		± 0.08	± 0.2	$\mu\text{V}/^\circ\text{C}$
V_{OSO}	Output stage offset voltage	At RTI		± 60	± 170	μV
		At RTI, $T_A = -40^\circ\text{C}$ to $+125^\circ\text{C}$		± 0.2	± 0.35	$\mu\text{V}/^\circ\text{C}$
V_{OS}	Offset voltage	At RTI		$\pm 25 \pm 60 / G$	$\pm 55 \pm 170 / G$	μV
		At RTI, $T_A = -40^\circ\text{C}$ to $+125^\circ\text{C}$		$\pm 0.2 \pm 0.35 / G$		$\mu\text{V}/^\circ\text{C}$
PSRR	Power-supply rejection ratio	$G = 1$, $V_S = 4\text{ V}$ to 36 V , $V_{CM} = V_S / 2$		± 0.7	± 2.25	$\mu\text{V}/\text{V}$
		$G = 10$, $V_S = 4\text{ V}$ to 36 V , $V_{CM} = V_S / 2$		± 0.6		
		$G = 100$, $V_S = 4\text{ V}$ to 36 V , $V_{CM} = V_S / 2$		± 0.45		
		$G = 1000$, $V_S = 4\text{ V}$ to 36 V , $V_{CM} = V_S / 2$		± 0.3	± 0.8	
	Long-term stability			1 ⁽³⁾		μV
	Turn-on time to specified V_{OSI}		See the Typical Characteristics			
Z_{id}	Differential input impedance		100 6			G Ω pF
Z_{ic}	Common-mode input impedance		100 9.5			
V_{CM}	Common-mode voltage range	The input signal common-mode range can be calculated with this tool	$(V-) + 0.1$		$(V+) - 1.5$	V
CMRR	Common-mode rejection ratio	$G = 1$, at dc to 60 Hz, $V_{CM} = (V-) + 1.0\text{ V}$ to $(V+) - 2.5\text{ V}$	84	90		dB
		$G = 10$, at dc to 60 Hz, $V_{CM} = (V-) + 1.0\text{ V}$ to $(V+) - 2.5\text{ V}$	104	110		
		$G = 100$, at dc to 60 Hz, $V_{CM} = (V-) + 1.0\text{ V}$ to $(V+) - 2.5\text{ V}$	118	130		
		$G = 1000$, at dc to 60 Hz, $V_{CM} = (V-) + 1.0\text{ V}$ to $(V+) - 2.5\text{ V}$	118	130		
INPUT BIAS CURRENT						
I_{IB}	Input bias current			± 850	± 2500	pA
		$T_A = -40^\circ\text{C}$ to $+125^\circ\text{C}$		See Figure 10		$\text{pA}/^\circ\text{C}$
I_{OS}	Input offset current			± 850	± 2500	pA
		$T_A = -40^\circ\text{C}$ to $+125^\circ\text{C}$		See Figure 11		$\text{pA}/^\circ\text{C}$
INPUT VOLTAGE NOISE						
e_{NI}	Input voltage noise	$f = 1\text{ kHz}$, $G = 100$, $R_S = 0\ \Omega$		12.5		$\text{nV}/\sqrt{\text{Hz}}$
		$f = 0.1\text{ Hz}$ to 10 Hz , $G = 100$, $R_S = 0\ \Omega$		0.25		μV_{PP}
e_{NO}	Output voltage noise	$f = 1\text{ kHz}$, $G = 100$, $R_S = 0\ \Omega$		118		$\text{nV}/\sqrt{\text{Hz}}$
		$f = 0.1\text{ Hz}$ to 10 Hz , $G = 100$, $R_S = 0\ \Omega$		2.5		μV_{PP}
i_N	Input current noise	$f = 1\text{ kHz}$		440		$\text{fA}/\sqrt{\text{Hz}}$
		$f = 0.1\text{ Hz}$ to 10 Hz		10		pA_{PP}
GAIN						
G	Gain equation		$1 + (50\text{ k}\Omega / R_G)$			V/V
	Gain range		1		1000	V/V
E_G	Gain error	$G = 1$, $(V-) + 0.5\text{ V} \leq V_O \leq (V+) - 1.5\text{ V}$		$\pm 0.007\%$	$\pm 0.025\%$	
		$G = 10$, $(V-) + 0.5\text{ V} \leq V_O \leq (V+) - 1.5\text{ V}$		$\pm 0.05\%$	$\pm 0.20\%$	
		$G = 100$, $(V-) + 0.5\text{ V} \leq V_O \leq (V+) - 1.5\text{ V}$		$\pm 0.06\%$	$\pm 0.20\%$	
		$G = 1000$, $(V-) + 0.5\text{ V} \leq V_O \leq (V+) - 1.5\text{ V}$		$\pm 0.2\%$	$\pm 0.50\%$	
	Gain versus temperature	$G = 1$, $T_A = -40^\circ\text{C}$ to $+125^\circ\text{C}$		1	5	ppm/ $^\circ\text{C}$
		$G > 1$ ⁽⁴⁾ , $T_A = -40^\circ\text{C}$ to $+125^\circ\text{C}$		15	50	
	Gain nonlinearity	$G = 1$, $V_O = -10\text{ V}$ to $+10\text{ V}$		3	8	ppm
		$G > 1$, $V_O = -10\text{ V}$ to $+10\text{ V}$		See Figure 42 to Figure 45		

(1) Total V_{OS} , referred-to-input = $(V_{OSI}) + (V_{OSO} / G)$.

(2) RTI = Referred-to-input.

(3) 300-hour life test at 150°C demonstrated a randomly distributed variation of approximately $1\ \mu\text{V}$.

(4) Does not include effects of external resistor R_G .

Electrical Characteristics: $V_S = \pm 4\text{ V}$ to $\pm 18\text{ V}$ ($V_S = 8\text{ V}$ to 36 V) (continued)

 At $T_A = 25^\circ\text{C}$, $R_L = 10\text{ k}\Omega$, $V_{REF} = V_S / 2$, and $G = 1$, unless otherwise noted.

PARAMETER		TEST CONDITIONS	MIN	TYP	MAX	UNIT
OUTPUT						
Output voltage swing from rail ⁽⁵⁾		$R_L = 10\text{ k}\Omega$ ⁽⁵⁾		220	250	mV
Capacitive load drive				1		nF
I_{SC}	Short-circuit current	Continuous to common		± 18		mA
FREQUENCY RESPONSE						
BW	Bandwidth, -3 dB	$G = 1$		600		kHz
		$G = 10$		95		
		$G = 100$		15		
		$G = 1000$		1.5		
SR	Slew rate	$G = 1$, $V_S = \pm 18\text{ V}$, $V_O = 10\text{-V}$ step		0.9		V/ μs
		$G = 100$, $V_S = \pm 18\text{ V}$, $V_O = 10\text{-V}$ step		0.17		
t_S	Settling time	To 0.1%	$G = 1$, $V_S = \pm 18\text{ V}$, $V_{STEP} = 10\text{ V}$		50	μs
			$G = 100$, $V_S = \pm 18\text{ V}$, $V_{STEP} = 10\text{ V}$		400	
		To 0.01%	$G = 1$, $V_S = \pm 18\text{ V}$, $V_{STEP} = 10\text{ V}$		60	μs
			$G = 100$, $V_S = \pm 18\text{ V}$, $V_{STEP} = 10\text{ V}$		500	
Overload recovery		50% overdrive		75		μs
REFERENCE INPUT						
R_{IN}	Input impedance			40		k Ω
Voltage range			V-		V+	V
POWER SUPPLY						
Voltage range	Single		4		36	V
	Dual		± 2		± 18	
I_Q	Quiescent current	$V_{IN} = V_S / 2$		1.4	1.6	mA
		$T_A = -40^\circ\text{C}$ to $+125^\circ\text{C}$			1.8	
TEMPERATURE RANGE						
Specified temperature range			-40		125	$^\circ\text{C}$
Operating temperature range			-55		150	$^\circ\text{C}$

 (5) See *Typical Characteristics* curves, *Output Voltage Swing vs Output Current* (Figure 19 to Figure 22).

6.6 Electrical Characteristics: $V_S = \pm 2\text{ V}$ to $< \pm 4\text{ V}$ ($V_S = 4\text{ V}$ to $< 8\text{ V}$)

At $T_A = 25^\circ\text{C}$, $R_L = 10\text{ k}\Omega$, $V_{REF} = V_S / 2$, and $G = 1$, unless otherwise noted. Specifications not shown are identical to the *Electrical Characteristics* table for $V_S = \pm 2\text{ V}$ to $\pm 18\text{ V}$ ($V_S = 8\text{ V}$ to 36 V).

PARAMETER		TEST CONDITIONS	MIN	TYP	MAX	UNIT
INPUT⁽¹⁾						
V_{OSI}	Input stage offset voltage	At RTI ⁽²⁾		± 25	± 55	μV
		At RTI, $T_A = -40^\circ\text{C}$ to $+125^\circ\text{C}$		± 0.08	± 0.2	$\mu\text{V}/^\circ\text{C}$
V_{OSO}	Output stage offset voltage	At RTI		± 60	± 170	μV
		At RTI, $T_A = -40^\circ\text{C}$ to $+125^\circ\text{C}$		± 0.2	± 0.35	$\mu\text{V}/^\circ\text{C}$
V_{OS}	Offset voltage	At RTI	$\pm 25 \pm 60 / G$	$\pm 55 \pm 170 / G$		μV
		At RTI, $T_A = -40^\circ\text{C}$ to $+125^\circ\text{C}$		$\pm 0.2 \pm 0.35 / G$		$\mu\text{V}/^\circ\text{C}$
	Long-term stability			1 ⁽³⁾		μV
	Turn-on time to specified V_{OSI}		See the Typical Characteristics			
Z_{id}	Differential input impedance		100 6			G Ω pF
Z_{ic}	Common-mode input impedance		100 9.5			
V_{CM}	Common-mode voltage range	$V_O = 0\text{ V}$, the input signal common-mode range can be calculated with this tool	(V-)		(V+) - 1.5	V
CMRR	Common-mode rejection ratio	$G = 1$, at dc to 60 Hz, $V_{CM} = (V-) + 1.0\text{ V}$ to $(V+) - 2.5\text{ V}$	80	90		dB
		$G = 10$, at dc to 60 Hz, $V_{CM} = (V-) + 1.0\text{ V}$ to $(V+) - 2.5\text{ V}$	94	110		
		$G = 100$, at dc to 60 Hz, $V_{CM} = (V-) + 1.0\text{ V}$ to $(V+) - 2.5\text{ V}$	102	120		
		$G = 1000$, at dc to 60 Hz, $V_{CM} = (V-) + 1.0\text{ V}$ to $(V+) - 2.5\text{ V}$	102	120		
INPUT BIAS CURRENT						
I_{IB}	Input bias current			± 850	± 2500	pA
		$T_A = -40^\circ\text{C}$ to $+125^\circ\text{C}$		See Figure 10		pA/ $^\circ\text{C}$
I_{OS}	Input offset current			± 850	± 2500	pA
		$T_A = -40^\circ\text{C}$ to $+125^\circ\text{C}$		See Figure 11		pA/ $^\circ\text{C}$
INPUT VOLTAGE NOISE						
e_{NI}	Input voltage noise	$f = 1\text{ kHz}$, $G = 100$, $R_S = 0\ \Omega$		12.5		nV/ $\sqrt{\text{Hz}}$
		$f = 0.1\text{ Hz}$ to 10 Hz , $G = 100$, $R_S = 0\ \Omega$		0.25		μV_{PP}
e_{NO}	Output voltage noise	$f = 1\text{ kHz}$, $G = 100$, $R_S = 0\ \Omega$		118		nV/ $\sqrt{\text{Hz}}$
		$f = 0.1\text{ Hz}$ to 10 Hz , $G = 100$, $R_S = 0\ \Omega$		2.5		μV_{PP}
i_N	Input current noise	$f = 1\text{ kHz}$		430		fA/ $\sqrt{\text{Hz}}$
		$f = 0.1\text{ Hz}$ to 10 Hz		10		pA $_{PP}$
GAIN						
G	Gain equation		$1 + (50\text{ k}\Omega / R_G)$			V/V
	Gain range		1		1000	V/V
E_G	Gain error	$G = 1$, $(V-) + 0.5\text{ V} \leq V_O \leq (V+) - 1.5\text{ V}$		$\pm 0.007\%$	$\pm 0.05\%$	
		$G = 10$, $(V-) + 0.5\text{ V} \leq V_O \leq (V+) - 1.5\text{ V}$		$\pm 0.07\%$	$\pm 0.2\%$	
		$G = 100$, $(V-) + 0.5\text{ V} \leq V_O \leq (V+) - 1.5\text{ V}$		$\pm 0.07\%$	$\pm 0.2\%$	
		$G = 1000$, $(V-) + 0.5\text{ V} \leq V_O \leq (V+) - 1.5\text{ V}$		$\pm 0.25\%$	$\pm 0.5\%$	
	Gain versus temperature	$G = 1$, $T_A = -40^\circ\text{C}$ to $+125^\circ\text{C}$		1	5	ppm/ $^\circ\text{C}$
		$G > 1$ ⁽⁴⁾ , $T_A = -40^\circ\text{C}$ to $+125^\circ\text{C}$		15	50	
	Gain nonlinearity	$G = 1$, $V_O = (V-) + 0.5\text{ V} \leq V_O \leq (V+) - 1.5\text{ V}$		3	8	ppm

(1) Total V_{OS} , referred-to-input = $(V_{OSI}) + (V_{OSO} / G)$.

(2) RTI = Referred-to-input.

(3) 300-hour life test at 150°C demonstrated randomly distributed variation of approximately $1\ \mu\text{V}$.

(4) Does not include effects of external resistor R_G .

Electrical Characteristics: $V_S = \pm 2\text{ V}$ to $< \pm 4\text{ V}$ ($V_S = 4\text{ V}$ to $< 8\text{ V}$) (continued)

At $T_A = 25^\circ\text{C}$, $R_L = 10\text{ k}\Omega$, $V_{\text{REF}} = V_S / 2$, and $G = 1$, unless otherwise noted. Specifications not shown are identical to the *Electrical Characteristics* table for $V_S = \pm 2\text{ V}$ to $\pm 18\text{ V}$ ($V_S = 8\text{ V}$ to 36 V).

PARAMETER		TEST CONDITIONS	MIN	TYP	MAX	UNIT
OUTPUT						
	Output voltage swing from rail ⁽⁵⁾	$R_L = 10\text{ k}\Omega$		220	250	mV
	Capacitive load drive			1		nF
I_{SC}	Short-circuit current	Continuous to common		± 18		mA
FREQUENCY RESPONSE						
BW	Bandwidth, –3 dB	$G = 1$		600		kHz
		$G = 10$		95		
		$G = 100$		15		
		$G = 1000$		1.5		
SR	Slew rate	$G = 1, V_S = 5\text{ V}, V_O = 4\text{-V step}$		0.9		V/ μs
		$G = 100, V_S = 5\text{ V}, V_O = 4\text{-V step}$		0.17		
t_s	Settling time	To 0.1%	$G = 1, V_S = 5\text{ V}, V_{\text{STEP}} = 4\text{ V}$		50	μs
			$G = 100, V_S = 5\text{ V}, V_{\text{STEP}} = 4\text{ V}$		400	
		To 0.01%	$G = 1, V_S = 5\text{ V}, V_{\text{STEP}} = 4\text{ V}$		60	μs
			$G = 100, V_S = 5\text{ V}, V_{\text{STEP}} = 4\text{ V}$		500	
	Overload recovery	50% overdrive		75		μs
REFERENCE INPUT						
R_{IN}	Input impedance			40		k Ω
	Voltage range		V–		V+	V
POWER SUPPLY						
	Voltage range	Single		4	36	V
		Dual		± 2	± 18	
I_Q	Quiescent current	$V_{\text{IN}} = V_S / 2$		1.4	1.6	mA
		$T_A = -40^\circ\text{C}$ to $+125^\circ\text{C}$			1.8	
TEMPERATURE RANGE						
	Specified temperature range		–40		125	$^\circ\text{C}$
	Operating temperature range		–55		150	$^\circ\text{C}$

(5) See *Typical Characteristics* curves, *Output Voltage Swing vs Output Current* (Figure 19 to Figure 22).

6.7 Typical Characteristics

At $T_A = 25^\circ\text{C}$, $V_S = \pm 15\text{ V}$, $R_L = 10\text{ k}\Omega$, $V_{REF} = \text{midsupply}$, and $G = 1$, unless otherwise noted.

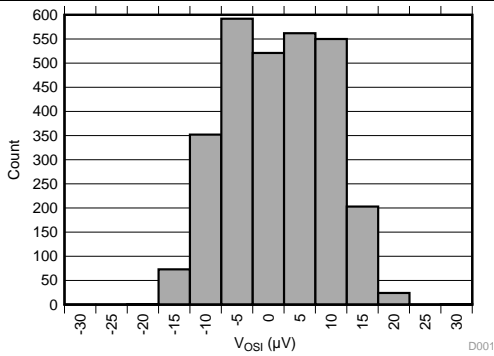

Figure 1. Input Voltage Offset Distribution

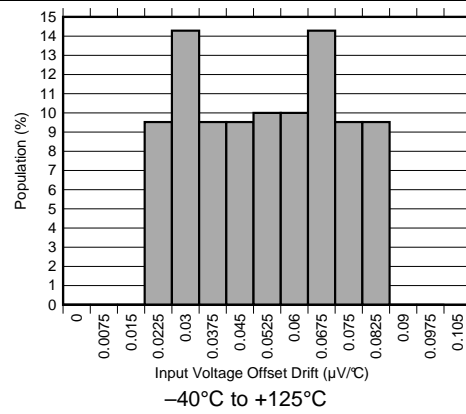

Figure 2. Input Voltage Offset Drift Distribution

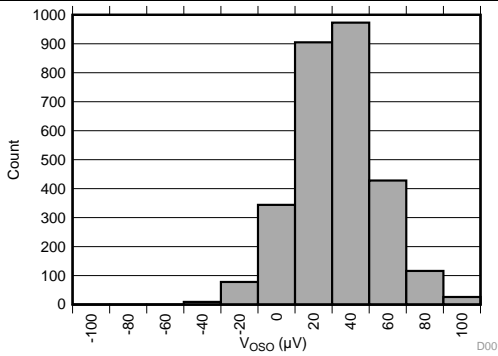

Figure 3. Output Voltage Offset Distribution

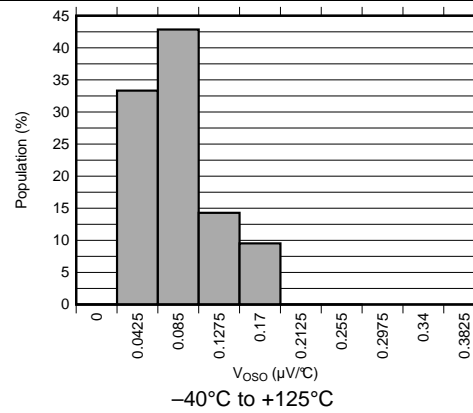

Figure 4. Output Voltage Offset Drift Distribution

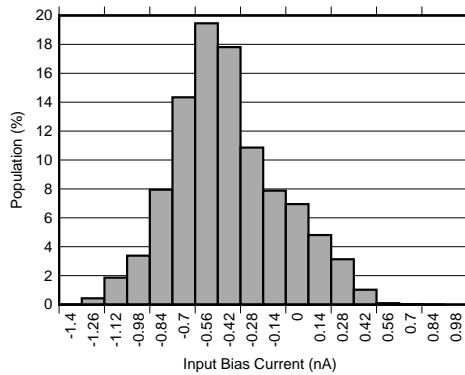

Figure 5. Input Bias Current Distribution

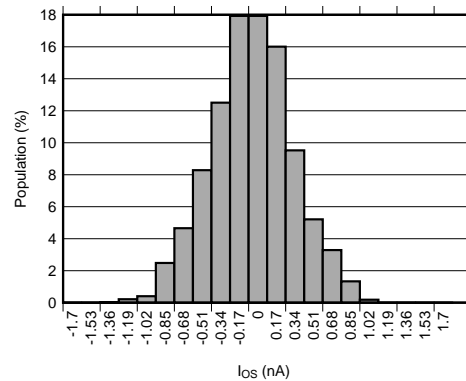
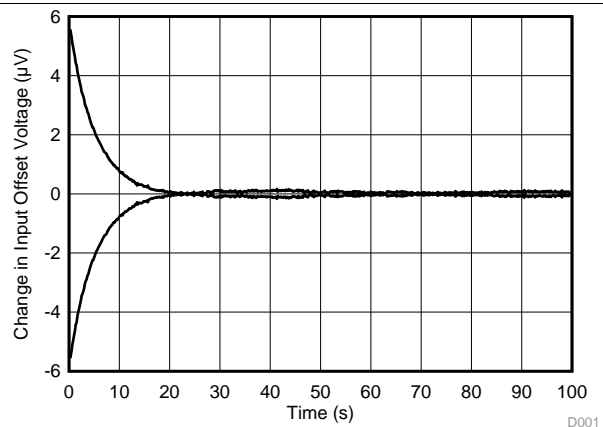
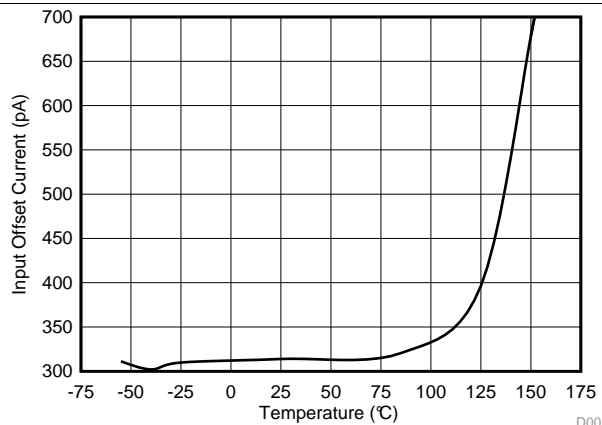
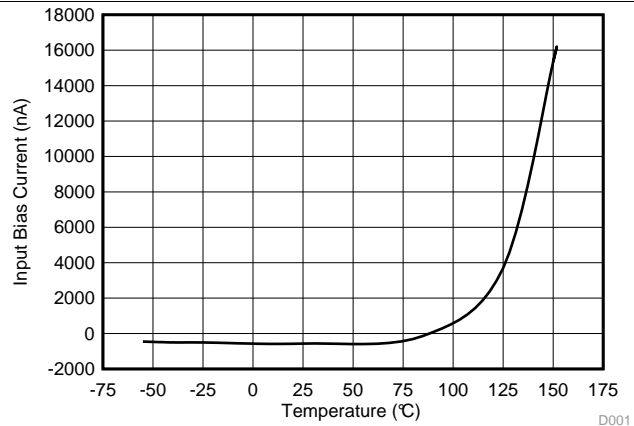
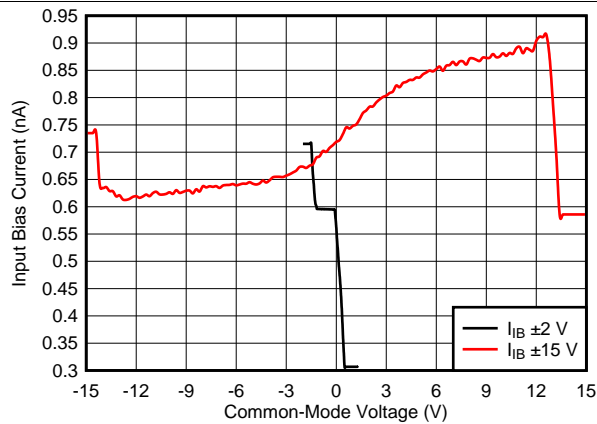
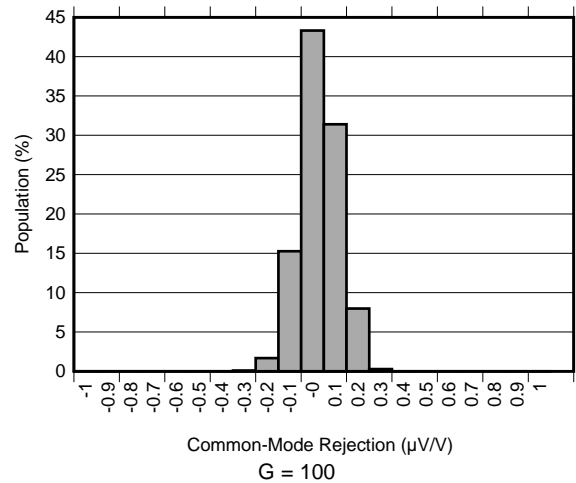
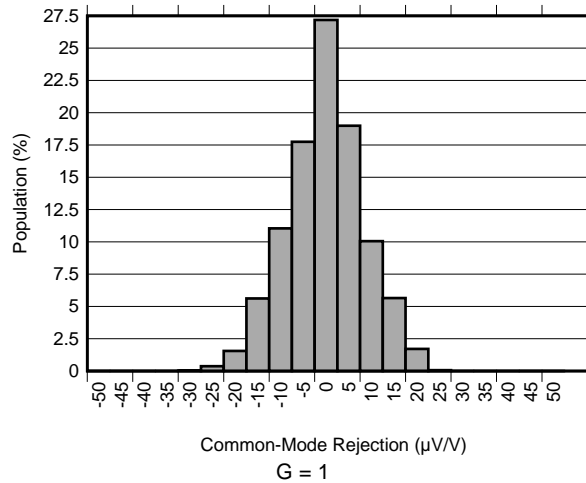

Figure 6. Input Offset Current Distribution

Typical Characteristics (continued)

At $T_A = 25^\circ\text{C}$, $V_S = \pm 15\text{ V}$, $R_L = 10\text{ k}\Omega$, $V_{REF} = \text{mid supply}$, and $G = 1$, unless otherwise noted.



Typical Characteristics (continued)

At $T_A = 25^\circ\text{C}$, $V_S = \pm 15\text{ V}$, $R_L = 10\text{ k}\Omega$, $V_{REF} = \text{midsupply}$, and $G = 1$, unless otherwise noted.

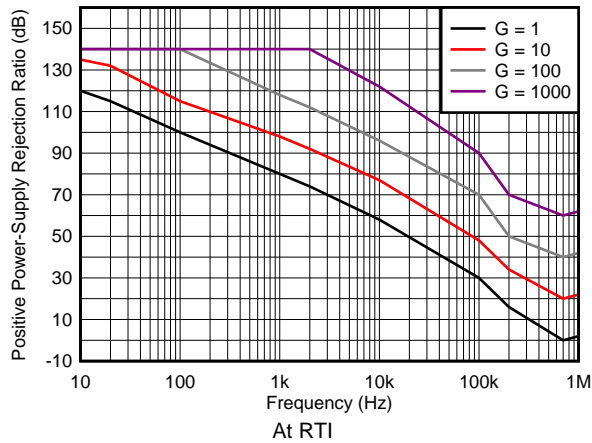

Figure 13. Positive PSRR vs Frequency

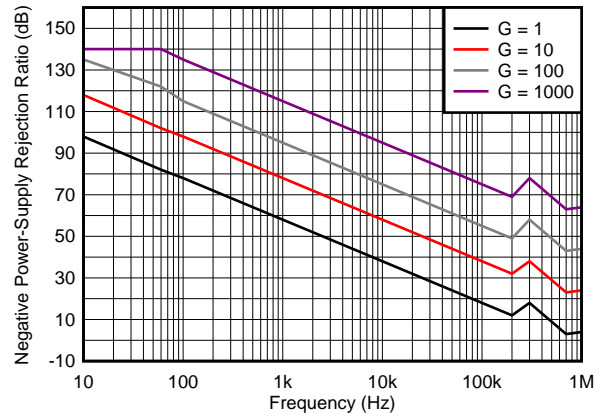

Figure 14. Negative PSRR vs Frequency

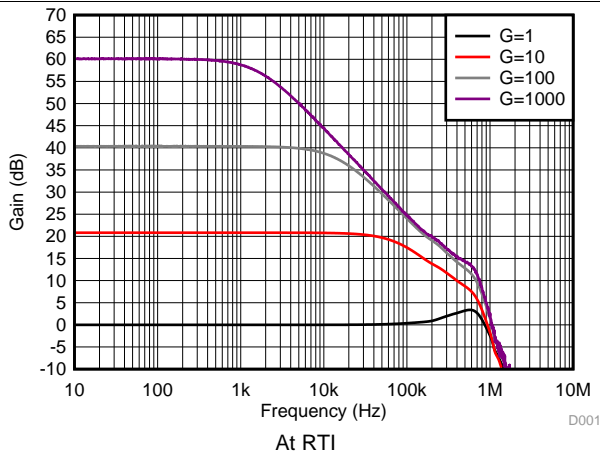

Figure 15. Gain vs Frequency

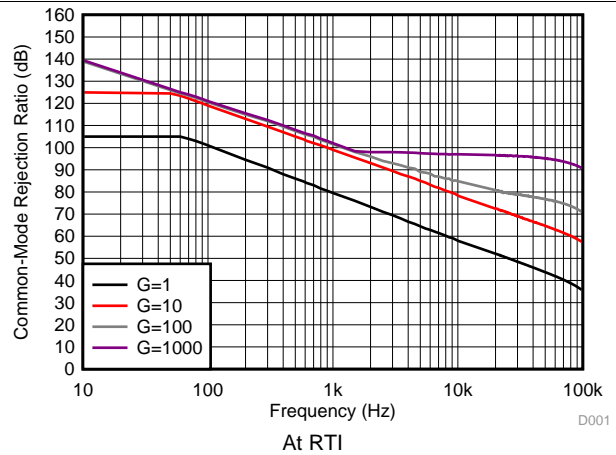

Figure 16. CMRR vs Frequency

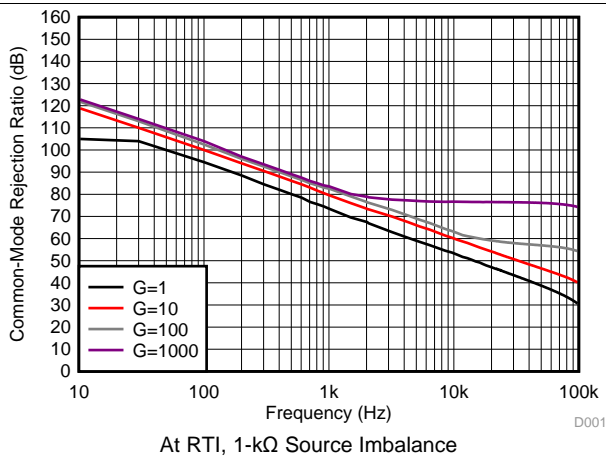

Figure 17. CMRR vs Frequency

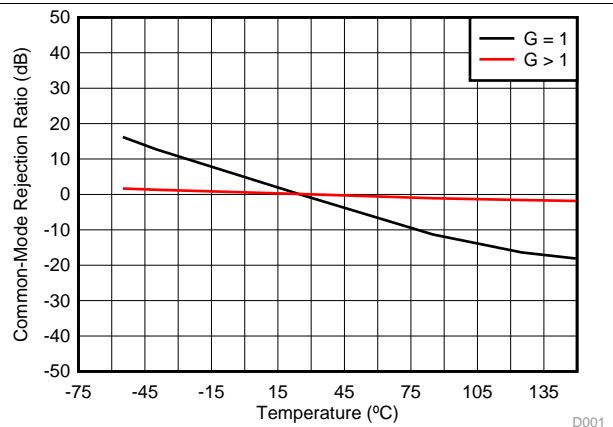
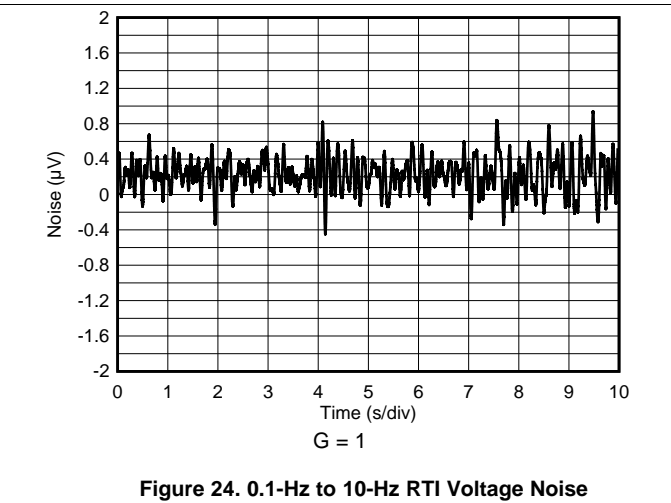
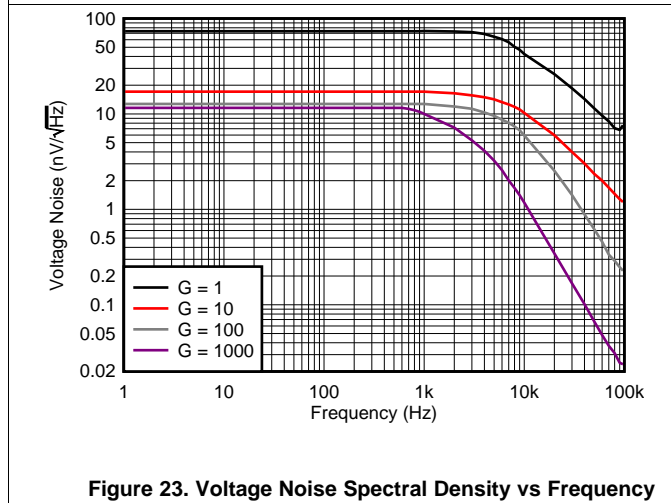
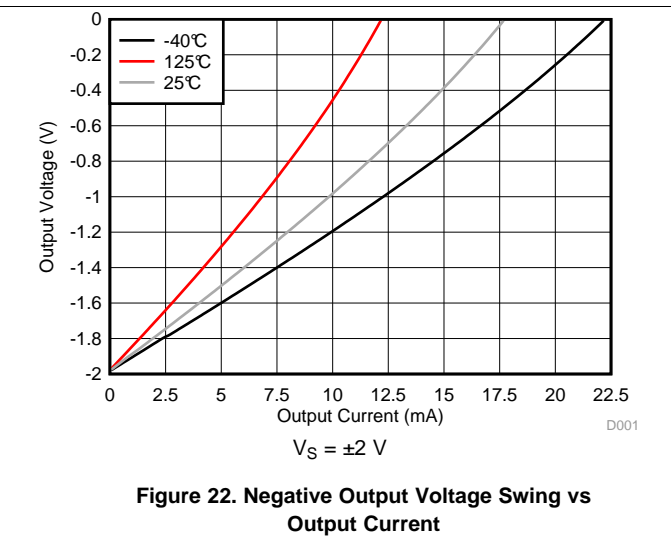
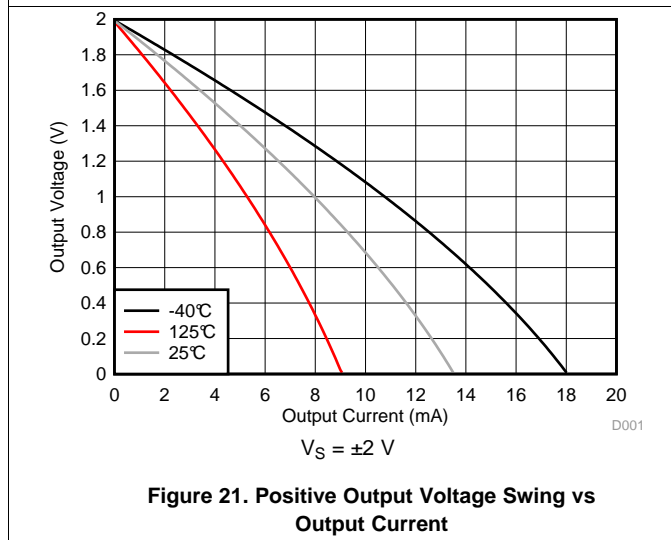
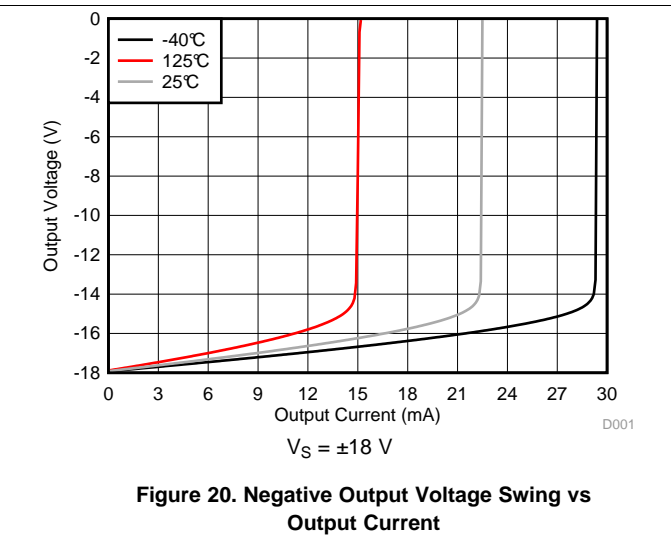
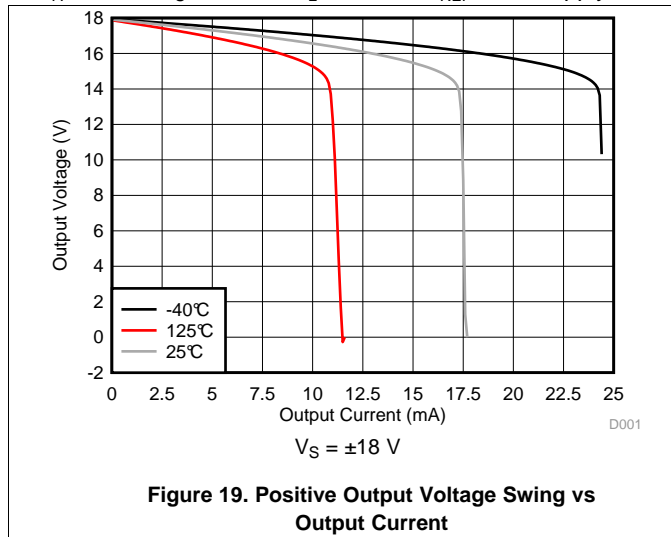

Figure 18. Common-Mode Rejection Ratio vs Temperature

Typical Characteristics (continued)

At $T_A = 25^\circ\text{C}$, $V_S = \pm 15\text{ V}$, $R_L = 10\text{ k}\Omega$, $V_{REF} = \text{mid supply}$, and $G = 1$, unless otherwise noted.



Typical Characteristics (continued)

At $T_A = 25^\circ\text{C}$, $V_S = \pm 15\text{ V}$, $R_L = 10\text{ k}\Omega$, $V_{REF} = \text{mid supply}$, and $G = 1$, unless otherwise noted.

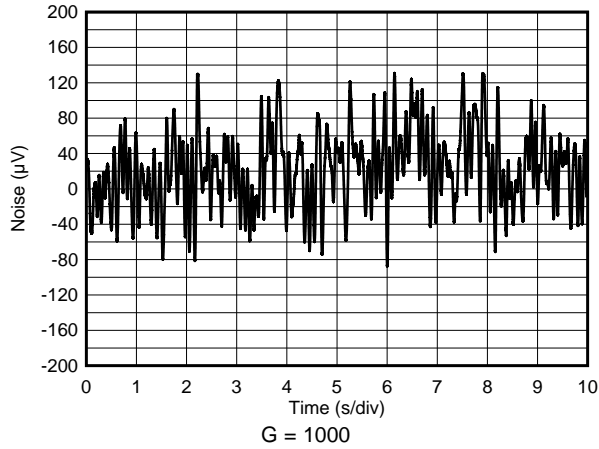

Figure 25. 0.1-Hz to 10-Hz RTI Voltage Noise

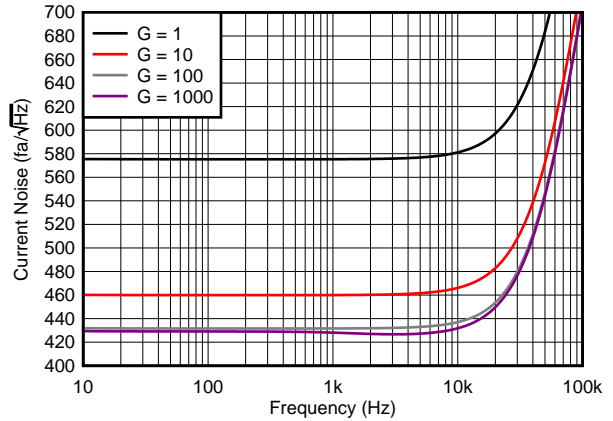

Figure 26. Current Noise Spectral Density vs Frequency

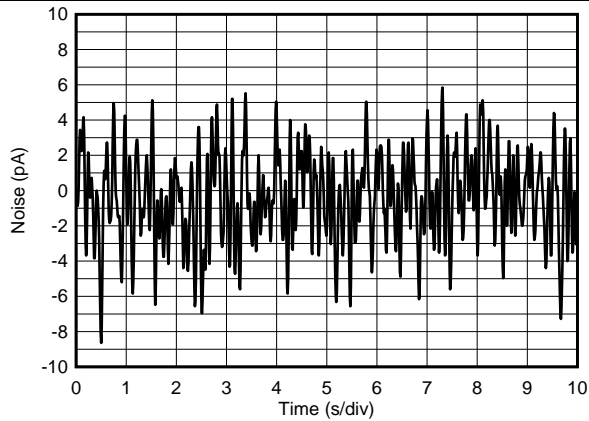

Figure 27. 0.1-Hz to 10-Hz RTI Current Noise

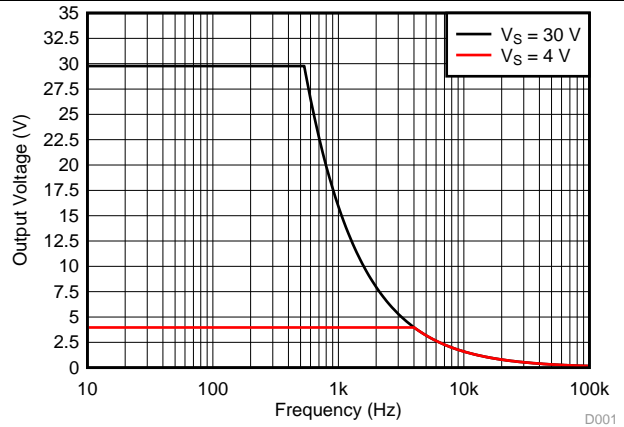

Figure 28. Large-Signal Response vs Frequency

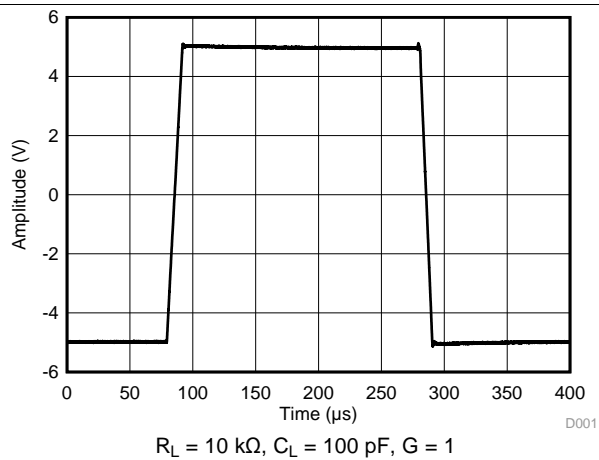

Figure 29. Large-Signal Pulse Response

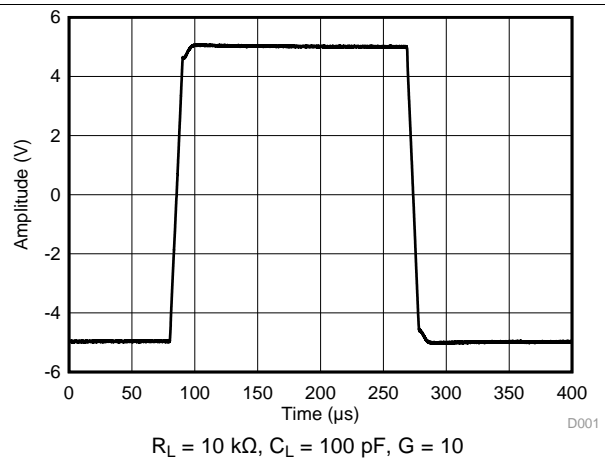

Figure 30. Large-Signal Pulse Response

Typical Characteristics (continued)

At $T_A = 25^\circ\text{C}$, $V_S = \pm 15\text{ V}$, $R_L = 10\text{ k}\Omega$, $V_{REF} = \text{mid supply}$, and $G = 1$, unless otherwise noted.

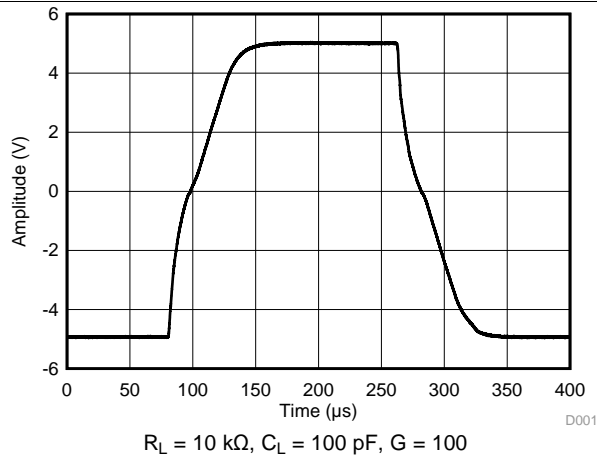

Figure 31. Large-Signal Pulse Response

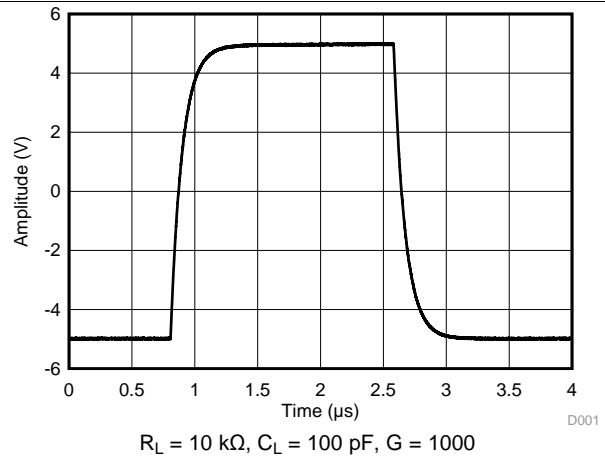

Figure 32. Large-Signal Pulse Response

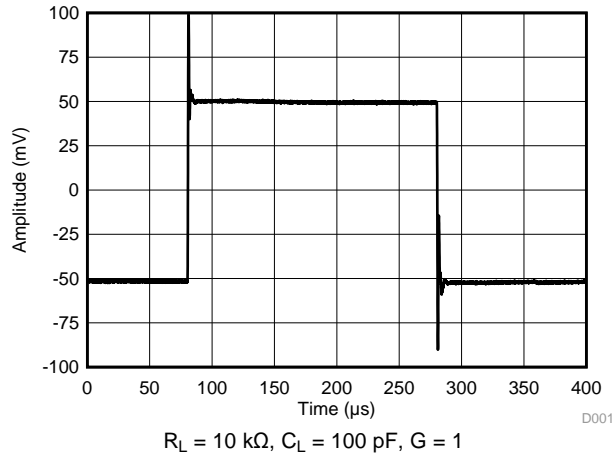

Figure 33. Small-Signal Pulse Response

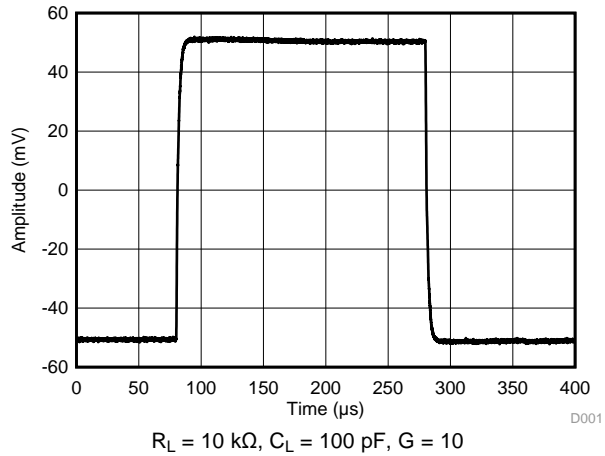

Figure 34. Small-Signal Pulse Response

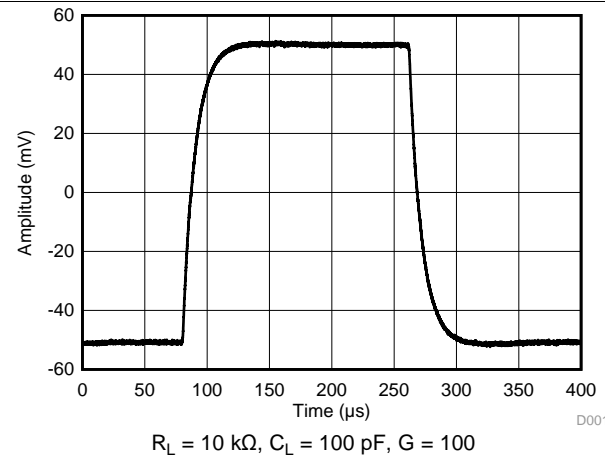

Figure 35. Small-Signal Pulse Response

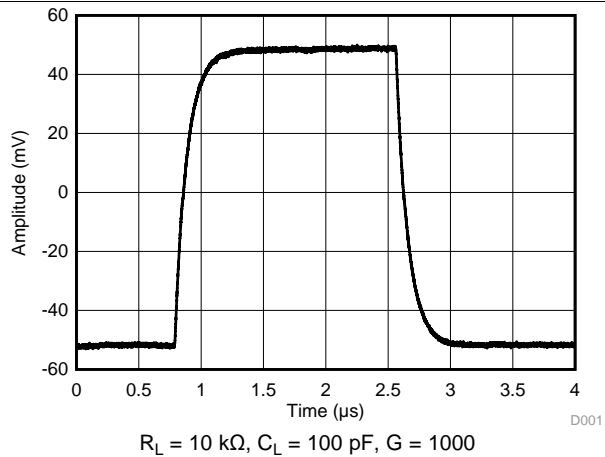

Figure 36. Small-Signal Pulse Response

Typical Characteristics (continued)

At $T_A = 25^\circ\text{C}$, $V_S = \pm 15\text{ V}$, $R_L = 10\text{ k}\Omega$, $V_{REF} = \text{mid supply}$, and $G = 1$, unless otherwise noted.

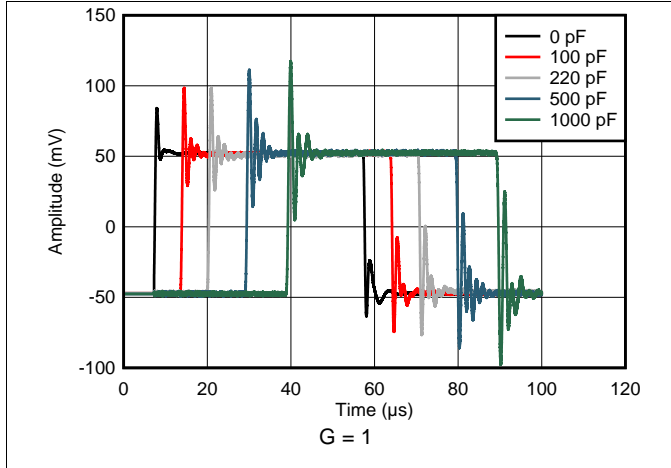

Figure 37. Small-Signal Response vs Capacitive Load

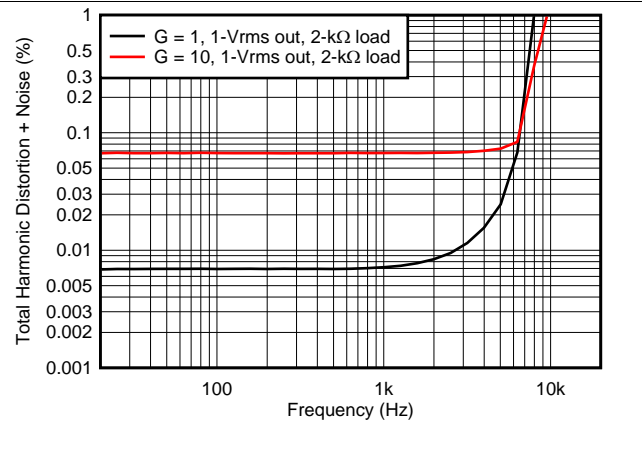

Figure 38. Total Harmonic Distortion + Noise vs Frequency

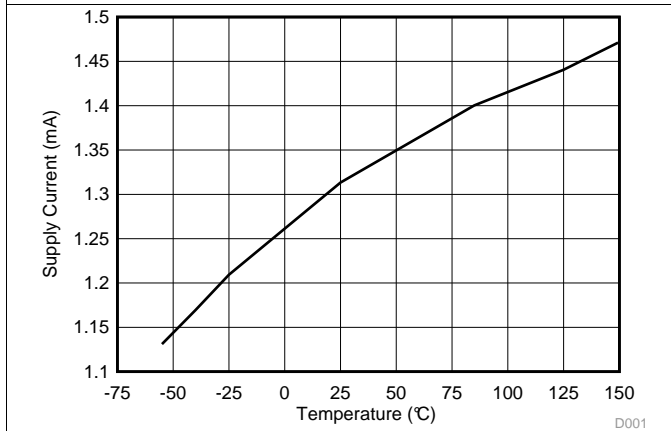

Figure 39. Supply Current vs Temperature

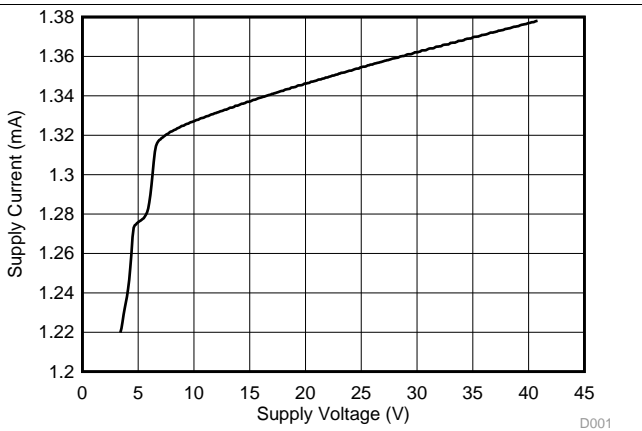

Figure 40. Supply Current vs Supply Voltage

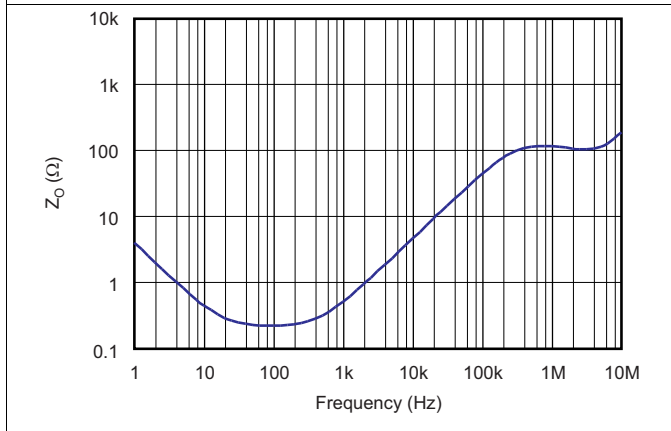

Figure 41. Open-Loop Output Impedance

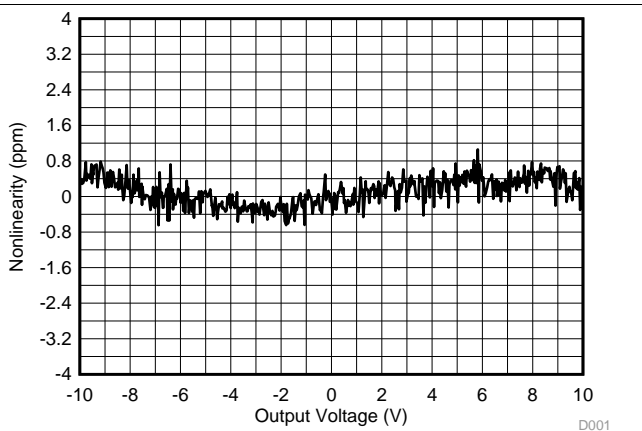

Figure 42. Gain Nonlinearity

Typical Characteristics (continued)

At $T_A = 25^\circ\text{C}$, $V_S = \pm 15\text{ V}$, $R_L = 10\text{ k}\Omega$, $V_{REF} = \text{mid supply}$, and $G = 1$, unless otherwise noted.

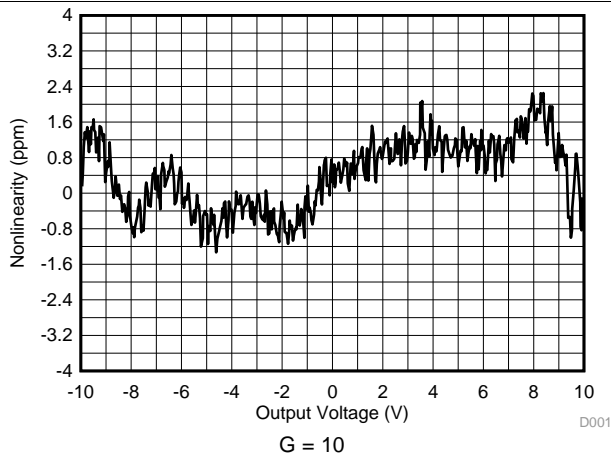

Figure 43. Gain Nonlinearity

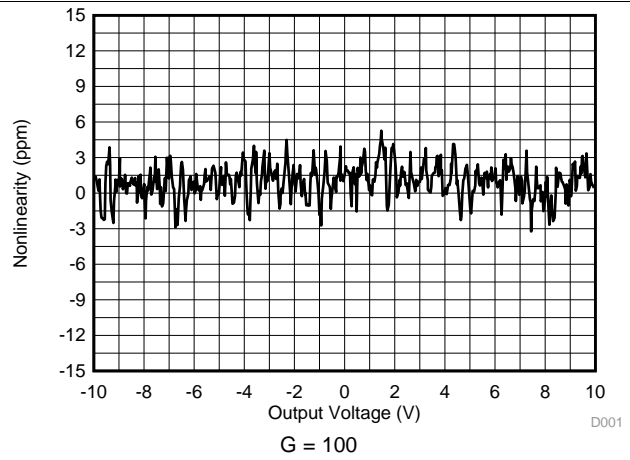

Figure 44. Gain Nonlinearity

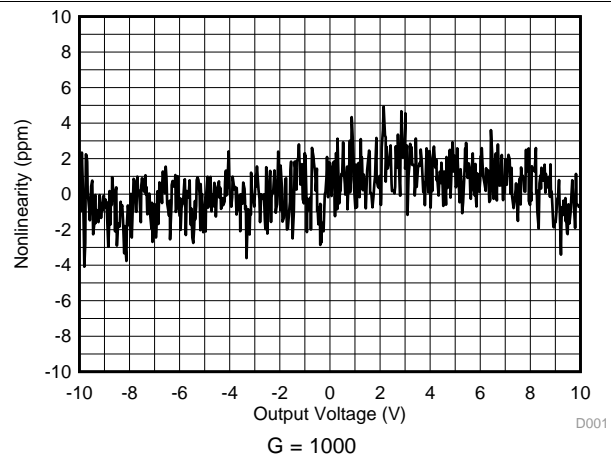

Figure 45. Gain Nonlinearity

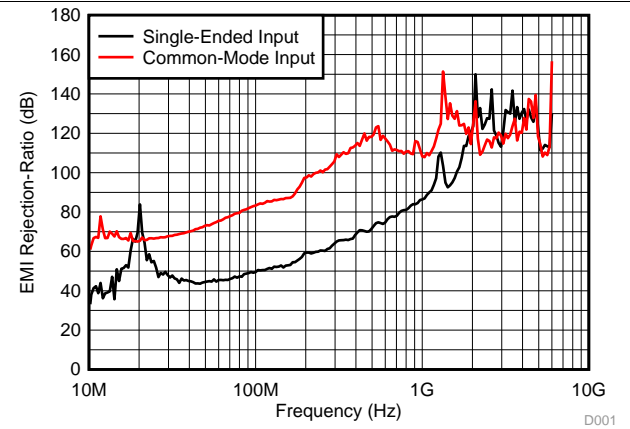

Figure 46. EMIRR

7 Detailed Description

7.1 Overview

The INA188 is a monolithic instrumentation amplifier (INA) based on the 36-V, precision zero-drift OPA188 (operational amplifier) core. The INA188 also integrates laser-trimmed resistors to ensure excellent common-mode rejection and low gain error. The combination of the zero-drift amplifier core and the precision resistors allows this device to achieve outstanding dc precision and makes the INA188 ideal for many high-voltage industrial applications.

7.2 Functional Block Diagram

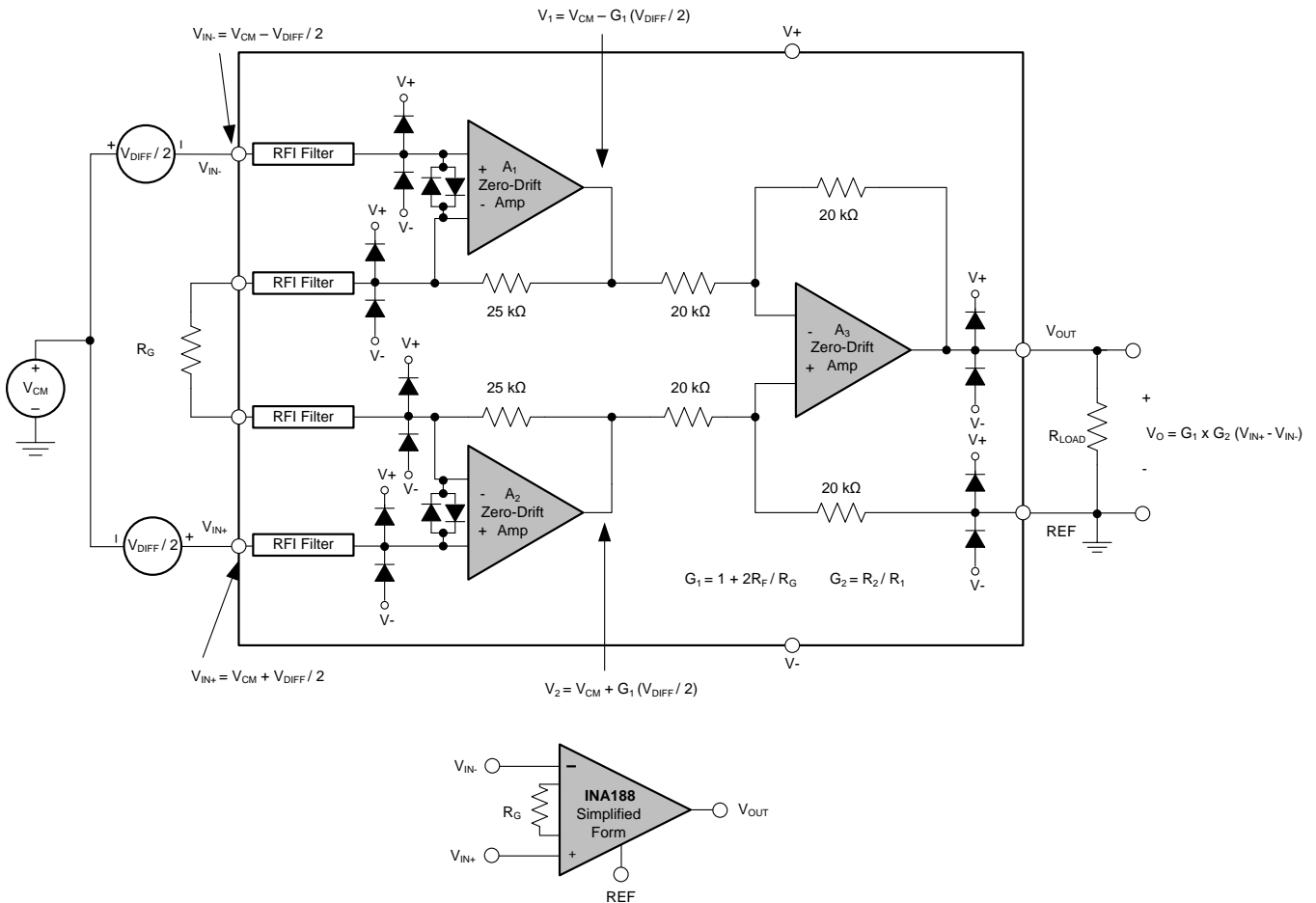

7.3 Feature Description

7.3.1 Inside the INA188

The [Functional Block Diagram](#) section provides a detailed diagram for the INA188, including the ESD protection and radio frequency interference (RFI) filtering. Instrumentation amplifiers are commonly represented in a simplified form, as shown in [Figure 47](#).

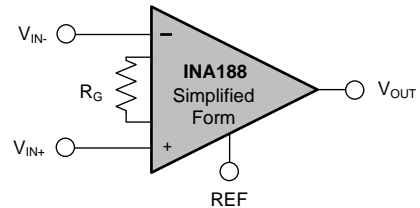

Figure 47. INA Simplified Form

A brief description of the internal operation is as follows:

The differential input voltage applied across R_G causes a signal current to flow through the R_G resistor and both R_F resistors. The output difference amplifier (A_3) removes the common-mode component of the input signal and refers the output signal to the REF pin.

The equations shown in the [Functional Block Diagram](#) section describe the output voltages of A_1 and A_2 . Understanding the internal node voltages is useful to avoid saturating the device and to ensure proper device operation.

7.3.2 Setting the Gain

The gain of the INA188 is set by a single external resistor, R_G , connected between pins 1 and 8. The value of R_G is selected according to [Equation 1](#):

$$G = 1 + \frac{50 \text{ k}\Omega}{R_G} \quad (1)$$

[Table 1](#) lists several commonly-used gains and resistor values. The 50-k Ω term in [Equation 1](#) comes from the sum of the two internal 25-k Ω feedback resistors. These on-chip resistors are laser-trimmed to accurate absolute values. The accuracy and temperature coefficients of these resistors are included in the gain accuracy and drift specifications of the INA188.

Table 1. Commonly-Used Gains and Resistor Values

DESIRED GAIN	R_G (Ω)	NEAREST 1% R_G (Ω)
1	NC ⁽¹⁾	NC
2	50k	49.9k
5	12.5k	12.4k
10	5.556k	5.49k
20	2.632k	2.61k
50	1.02k	1.02k
100	505.1	511
200	251.3	249
500	100.2	100
1000	50.05	49.9

(1) NC denotes no connection. When using the SPICE model, the simulation does not converge unless a resistor is connected to the R_G pins; use a very large resistor value.

7.3.3.3 Input Bias Current Clock Feedthrough

Zero-drift amplifiers, such as the INA188, use switching on their inputs to correct for the intrinsic offset and drift of the amplifier. Charge injection from the integrated switches on the inputs can introduce very short transients in the input bias current of the amplifier. The extremely short duration of these pulses prevents them from being amplified; however, the pulses can be coupled to the output of the amplifier through the feedback network. The most effective method to prevent transients in the input bias current from producing additional noise at the amplifier output is to use a low-pass filter (such as an RC network).

7.3.4 EMI Rejection

The INA188 uses integrated electromagnetic interference (EMI) filtering to reduce the effects of EMI from sources (such as wireless communications) and densely-populated boards with a mix of analog signal-chain and digital components. The INA188 is specifically designed to minimize susceptibility to EMI by incorporating an internal low-pass filter. Depending on the end-system requirements, additional EMI filters may be required near the signal inputs of the system, as well as incorporating known good practices such as using short traces, low-pass filters, and damping resistors combined with parallel and shielded signal routing. Texas Instruments developed a method to accurately measure the immunity of an amplifier over a broad frequency spectrum, extending from 10 MHz to 6 GHz. This method uses an EMI rejection ratio (EMIRR) to quantify the INA188 ability to reject EMI. Figure 49 and Figure 50 show the INA188 EMIRR graph for both differential and common-mode EMI rejection across this frequency range. Table 2 shows the EMIRR values for the INA188 at frequencies commonly encountered in real-world applications. Applications listed in Table 2 can be centered on or operated near the particular frequency shown.

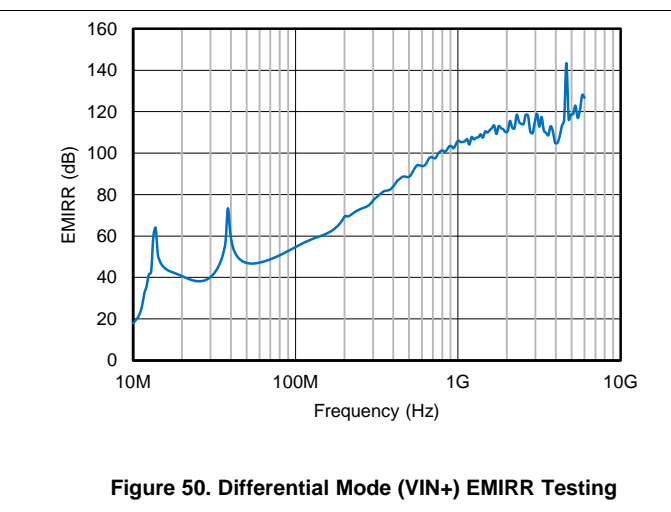
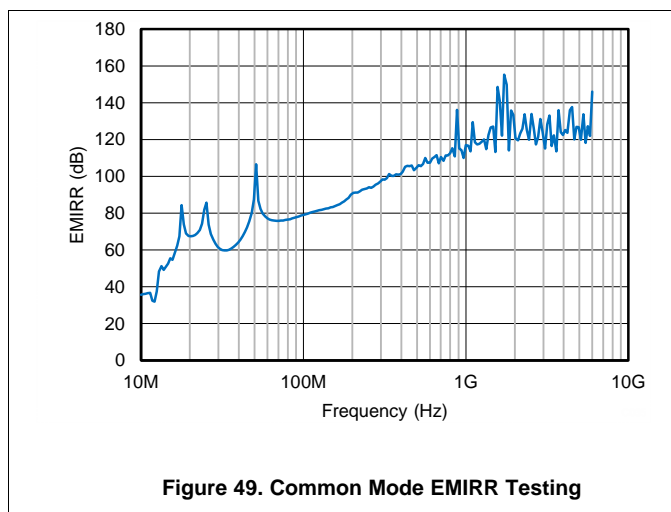

Table 2. INA188 EMIRR for Frequencies of Interest

FREQUENCY	APPLICATION OR ALLOCATION	DIFFERENTIAL (IN-P) EMIRR	COMMON-MODE EMIRR
400 MHz	Mobile radio, mobile satellite, space operation, weather, radar, ultrahigh-frequency (UHF) applications	83 dB	101 dB
900 MHz	Global system for mobile communications (GSM) applications, radio communication, navigation, GPS (to 1.6 GHz), GSM, aeronautical mobile, UHF applications	103 dB	118 dB
1.8 GHz	GSM applications, mobile personal communications, broadband, satellite, L-band (1 GHz to 2 GHz)	112 dB	125 dB
2.4 GHz	802.11b, 802.11g, 802.11n, Bluetooth®, mobile personal communications, industrial, scientific and medical (ISM) radio band, amateur radio and satellite, S-band (2 GHz to 4 GHz)	114 dB	123 dB
3.6 GHz	Radiolocation, aero communication and navigation, satellite, mobile, S-band	110 dB	121 dB
5.0 GHz	802.11a, 802.11n, aero communication and navigation, mobile communication, space and satellite operation, C-band (4 GHz to 8 GHz)	119 dB	123 dB

7.3.5 Input Protection and Electrical Overstress

Designers often ask questions about the capability of an amplifier to withstand electrical overstress. These questions tend to focus on the device inputs, but can involve the supply voltage pins or even the output pin. Each of these different pin functions have electrical stress limits determined by the voltage breakdown characteristics of the particular semiconductor fabrication process and specific circuits connected to the pin. Additionally, internal ESD protection is built into these circuits to protect them from accidental ESD events both before and during product assembly.

Having a good understanding of this basic ESD circuitry and its relevance to an electrical overstress event is helpful. The [Functional Block Diagram](#) section illustrates the ESD circuits contained in the INA188. The ESD protection circuitry involves several current-steering diodes connected from the input and output pins and routed back to the internal power-supply lines. This protection circuitry is intended to remain inactive during normal circuit operation.

The input pins of the INA188 are protected with internal diodes connected to the power-supply rails. These diodes clamp the applied signal to prevent the input circuitry from being damaged. If the input signal voltage can exceed the power supplies by more than 0.3 V, limit the input signal current to less than 10 mA to protect the internal clamp diodes. This current limiting can generally be done with a series input resistor. Some signal sources are inherently current-limited and do not require limiting resistors.

7.3.6 Input Common-Mode Range

The linear input voltage range of the INA188 input circuitry extends from 100 mV inside the negative supply voltage to 1.5 V below the positive supply, and maintains 84-dB (minimum) common-mode rejection throughout this range. The common-mode range for most common operating conditions is best calculated using the [INA common-mode range calculating tool](#). The INA188 can operate over a wide range of power supplies and V_{REF} configurations, thus providing a comprehensive guide to common-mode range limits for all possible conditions is impractical.

The most commonly overlooked overload condition occurs when a circuit exceeds the output swing of A_1 and A_2 , which are internal circuit nodes that cannot be measured. Calculating the expected voltages at the output of A_1 and A_2 (see the [Functional Block Diagram](#) section) provides a check for the most common overload conditions. The designs of A_1 and A_2 are identical and the outputs can swing to within approximately 250 mV of the power-supply rails. For example, when the A_2 output is saturated, A_1 can continue to be in linear operation, responding to changes in the noninverting input voltage. This difference can give the appearance of linear operation but the output voltage is invalid.

7.4 Device Functional Modes

7.4.1 Single-Supply Operation

The INA188 can be used on single power supplies of 4 V to 36 V. Use the output REF pin to level shift the internal output voltage into a linear operating condition. Ideally, connecting the REF pin to a potential that is mid-supply avoids saturating the output of the input amplifiers (A_1 and A_2). Actual output voltage swing is limited to 250 mV above ground when the load is referred to ground. The typical characteristic curves, *Output Voltage Swing vs Output Current* ([Figure 19](#) to [Figure 22](#)) illustrates how the output voltage swing varies with output current. See the [Driving the Reference Pin](#) section for information on how to adequately drive the reference pin.

With single-supply operation, V_{IN+} and V_{IN-} must both be 0.1 V above ground for linear operation. For instance, the inverting input cannot be connected to ground to measure a voltage connected to the noninverting input.

Device Functional Modes (continued)

7.4.2 Offset Trimming

Most applications require no external offset adjustment; however, if necessary, adjustments can be made by applying a voltage to the REF pin. Figure 51 shows an optional circuit for trimming the output offset voltage. The voltage applied to the REF pin is summed at the output. The op amp buffer provides low impedance at the REF pin to preserve good common-mode rejection.

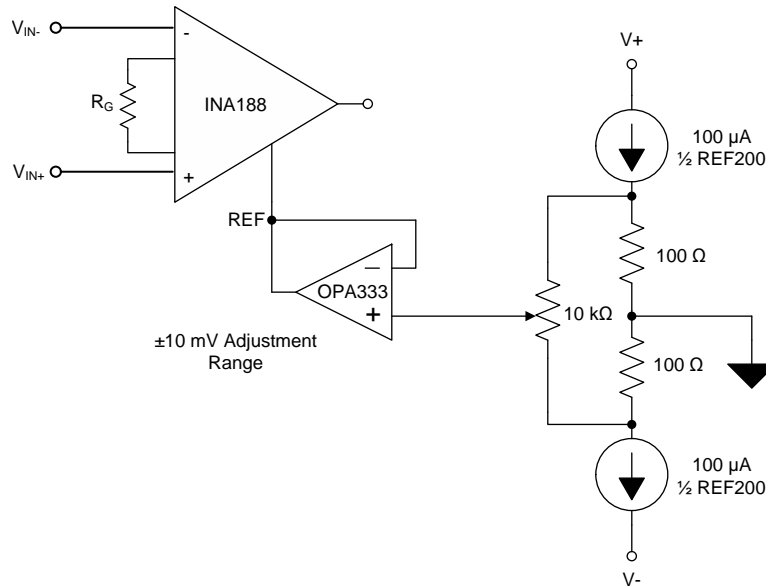

Figure 51. Optional Trimming of the Output Offset Voltage

Device Functional Modes (continued)

7.4.3 Input Bias Current Return Path

The input impedance of the INA188 is extremely high—approximately 20 GΩ. However, a path must be provided for the input bias current of both inputs. This input bias current is typically 750 pA. High input impedance means that this input bias current changes very little with varying input voltage.

Input circuitry must provide a path for this input bias current for proper operation. [Figure 52](#) shows various provisions for an input bias current path. Without a bias current path, the inputs float to a potential that exceeds the common-mode range of the INA188, and the input amplifiers saturate. If the differential source resistance is low, the bias current return path can be connected to one input (as shown in the thermocouple example in [Figure 52](#)). With a higher source impedance, using two equal resistors provides a balanced input with possible advantages of a lower input offset voltage as a result of bias current and better high-frequency common-mode rejection.

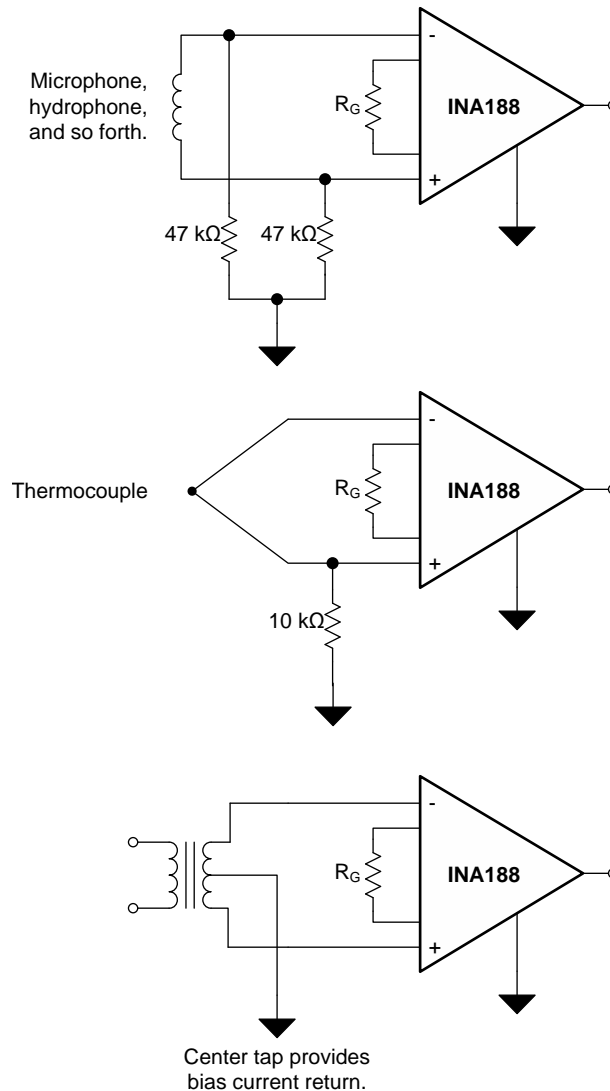

Figure 52. Providing an Input Common-Mode Current Path

Device Functional Modes (continued)

7.4.4 Driving the Reference Pin

The output voltage of the INA188 is developed with respect to the voltage on the reference pin. Often, the reference pin (pin 5) is connected to the low-impedance system ground in dual-supply operation. In single-supply operation, offsetting the output signal to a precise mid-supply level (for example, 2.5 V in a 5-V supply environment) can be useful. To accomplish this, a voltage source can be tied to the REF pin to level-shift the output so that the INA188 can drive a single-supply analog-to-digital converter (ADC).

For best performance, keep the source impedance to the REF pin below 5 Ω . As illustrated in the [Functional Block Diagram](#) section, the reference pin is internally connected to a 20-k Ω resistor. Additional impedance at the REF pin adds to this 20-k Ω resistor. The imbalance in the resistor ratios results in degraded common-mode rejection ratio (CMRR).

[Figure 53](#) shows two different methods of driving the reference pin with low impedance. The [OPA330](#) is a low-power, chopper-stabilized amplifier, and therefore offers excellent stability over temperature. The OPA330 is available in a space-saving SC70 and an even smaller chip-scale package. The [REF3225](#) is a precision reference in a small SOT23-6 package.

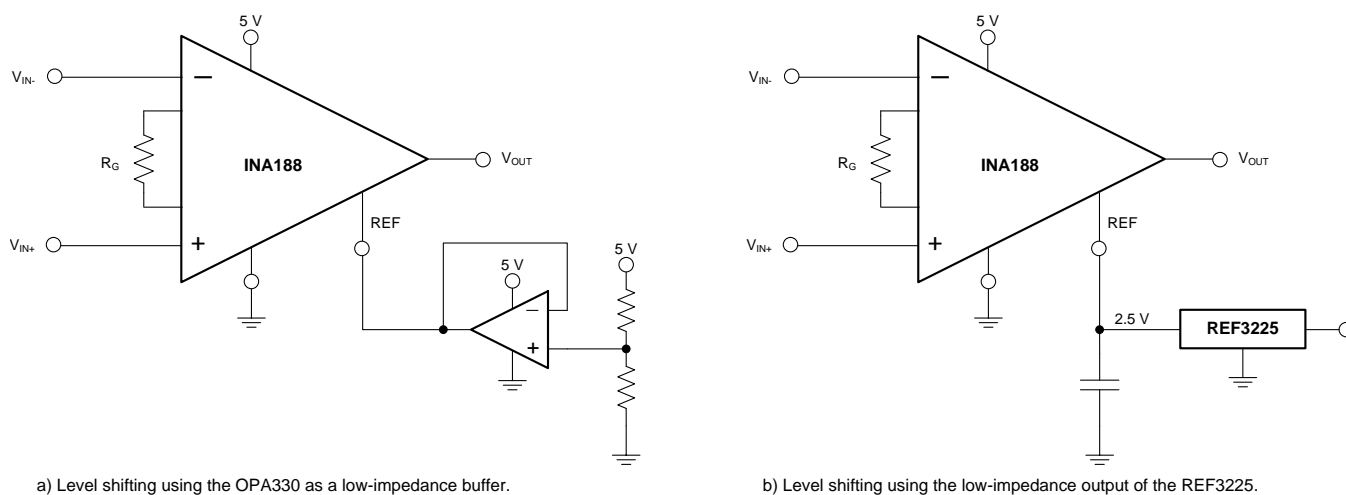

Figure 53. Options for Low-Impedance Level Shifting

Device Functional Modes (continued)

7.4.5 Error Sources Example

Most modern signal-conditioning systems calibrate errors at room temperature. However, calibration of errors that result from a change in temperature is normally difficult and costly. Therefore, minimizing these errors is important and can be done by choosing high-precision components (such as the INA188 that has improved specifications in critical areas that impact the precision of the overall system). Figure 54 shows an example application.

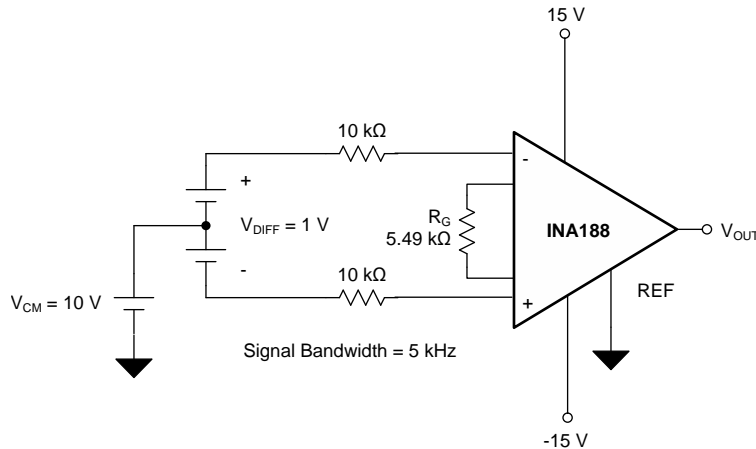

Figure 54. Example Application with $G = 10$ V/V and a 1-V Differential Voltage

Resistor-adjustable INAs such as the INA188 show the lowest gain error in $G = 1$ because of the inherently well-matched drift of the internal resistors of the differential amplifier. At gains greater than 1 (for instance, $G = 10$ V/V or $G = 100$ V/V) the gain error becomes a significant error source because of the contribution of the resistor drift of the 25-kΩ feedback resistors in conjunction with the external gain resistor. Except for very high-gain applications, gain drift is by far the largest error contributor compared to other drift errors, such as offset drift. The INA188 offers the lowest gain error over temperature in the marketplace for both $G > 1$ and $G = 1$ (no external gain resistor). Table 3 summarizes the major error sources in common INA applications and compares the two cases of $G = 1$ (no external resistor) and $G = 10$ (5.49-kΩ external resistor). As explained in Table 3, although the static errors (absolute accuracy errors) in $G = 1$ are almost twice as great as compared to $G = 10$, there are much fewer drift errors because of the much lower gain error drift. In most applications, these static errors can readily be removed during calibration in production. All calculations refer the error to the input for easy comparison and system evaluation.

Device Functional Modes (continued)
Table 3. Error Calculation

ERROR SOURCE	ERROR CALCULATION	SPECIFICATION	G = 10 ERROR (ppm)	G = 1 ERROR (ppm)
ABSOLUTE ACCURACY AT 25°C				
Input offset voltage	V_{OSI} / V_{DIFF}	65 μ V	65	65
Output offset voltage	$V_{OSO} / (G \times V_{DIFF})$	180 μ V	18	180
Input offset current	$I_{OS} \times \text{maximum } (R_{S+}, R_{S-}) / V_{DIFF}$	5 nA	50	50
Common-mode rejection ratio	$V_{CM} / (10^{CMRR/20} \times V_{DIFF})$	104 dB (G = 10), 84 dB (G = 1)	20	501
Total absolute accuracy error (ppm)			153	796
DRIFT TO 105°C				
Gain drift	$GTC \times (T_A - 25)$	35 ppm/°C (G = 10), 1 ppm/°C (G = 1)	2800	80
Input offset voltage drift	$(V_{OSI_TC} / V_{DIFF}) \times (T_A - 25)$	0.15 μ V/°C	12	12
Output offset voltage drift	$[V_{OSO_TC} / (G \times V_{DIFF})] \times (T_A - 25)$	0.85 μ V/°C	6.8	68
Offset current drift	$I_{OS_TC} \times \text{maximum } (R_{S+}, R_{S-}) \times (T_A - 25) / V_{DIFF}$	60 pA/°C	48	48
Total drift error (ppm)			2867	208
RESOLUTION				
Gain nonlinearity		5 ppm of FS	5	5
Voltage noise (1 kHz)	$\sqrt{BW} \times \sqrt{(e_{NI})^2 + \left[\frac{e_{NO}}{G}\right]^2} \times \frac{6}{V_{DIFF}}$	$e_{NI} = 18,$ $e_{NO} = 110$	9	47
Total resolution error (ppm)			14	52
TOTAL ERROR				
Total error (ppm)	Total error = sum of all error sources		3034	1056

8 Application and Implementation

NOTE

Information in the following applications sections is not part of the TI component specification, and TI does not warrant its accuracy or completeness. TI's customers are responsible for determining suitability of components for their purposes. Customers should validate and test their design implementation to confirm system functionality.

8.1 Application Information

The INA188 measures a small differential voltage with a high common-mode voltage developed between the noninverting and inverting input. The low offset drift in conjunction with no 1/f noise makes the INA188 suitable for a wide range of applications. The ability to set the reference pin to adjust the functionality of the output signal offers additional flexibility that is practical for multiple configurations.

8.2 Typical Application

Figure 55 shows the basic connections required for operating the INA188. Applications with noisy or high-impedance power supplies may require decoupling capacitors close to the device pins. The output is referred to the output reference (REF) pin that is normally grounded. The reference pin must be a low-impedance connection to assure good common-mode rejection.

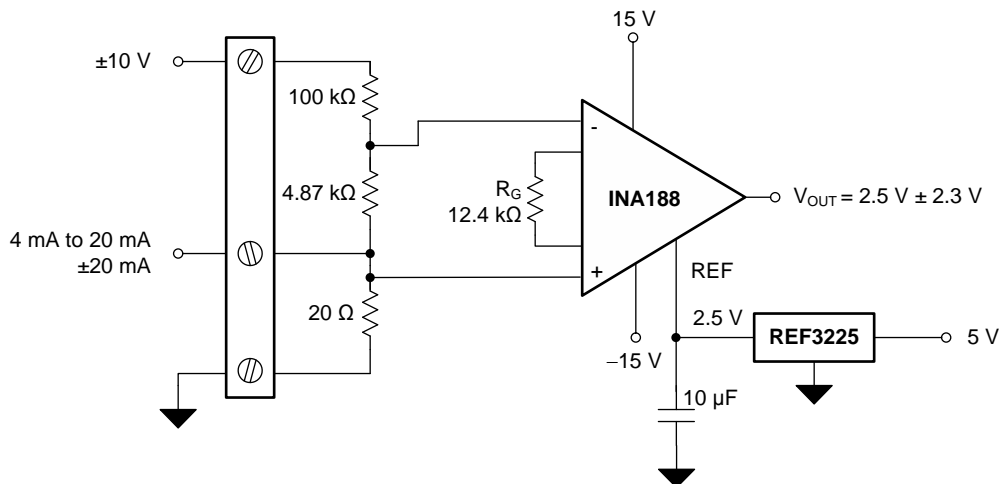

Figure 55. PLC Input (± 10 V, 4 mA to 20 mA)

8.2.1 Design Requirements

For this application, the design requirements are:

- 4-mA to 20-mA input with less than 20- Ω burden
- ± 20 -mA input with less than 20- Ω burden
- ± 10 -V input with impedance of approximately 100 k Ω
- Maximum 4-mA to 20-mA or ± 20 mA burden voltage equal to ± 0.4 V
- Output range within 0 V to 5 V

Typical Application (continued)

8.2.2 Detailed Design Procedure

The following steps must be applied for proper device functionality:

- For a 4-mA to 20-mA input, the maximum burden of 0.4 V must have a burden resistor equal to $0.4 / 0.02 = 20 \Omega$.
- To center the output within the 0-V to 5-V range, V_{REF} must equal 2.5 V.
- To keep the ± 20 -mA input linear within 0 V to 5 V, the gain resistor (R_G) must be 12.4 k Ω .
- To keep the ± 10 -V input within the 0-V to 5-V range, attenuation must be greater than 0.05.
- A 100-k Ω resistor in series with a 4.87-k Ω resistor provides 0.0466 attenuation of ± 10 V, well within the ± 2.5 -V linear limits.

8.2.3 Application Curve

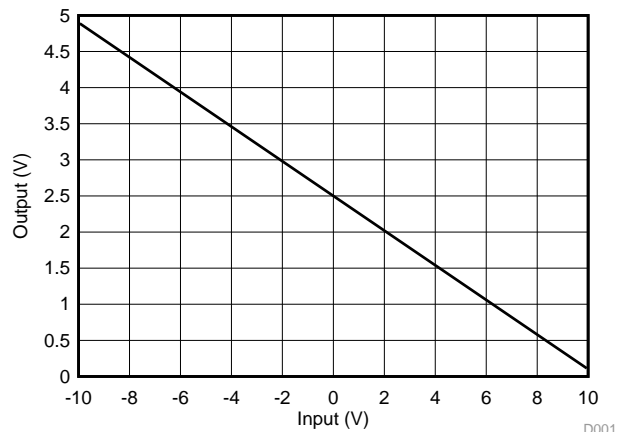

Figure 56. Plot of PLC Input Transfer Function D001

9 Power Supply Recommendations

The minimum power-supply voltage for the INA188 is ± 2 V and the maximum power-supply voltage is ± 18 V. This minimum and maximum range covers a wide range of power supplies. However, for optimum performance, ± 15 V is recommended. A 0.1- μ F bypass capacitor is recommended to be added at the input to compensate for the layout and power-supply source impedance.

10 Layout

10.1 Layout Guidelines

Attention to good layout practices is always recommended. For best operational performance of the device, use good printed circuit board (PCB) layout practices, including:

- Care must be taken to ensure that both input paths are well-matched for source impedance and capacitance to avoid converting common-mode signals into differential signals. In addition, parasitic capacitance at the gain-setting pins can also affect CMRR over frequency. For example, in applications that implement gain switching using switches or PhotoMOS[®] relays to change the value of R_G , select the component so that the switch capacitance is as small as possible.
- Noise can propagate into analog circuitry through the power pins of the circuit as a whole and of the device itself. Bypass capacitors are used to reduce the coupled noise by providing low-impedance power sources local to the analog circuitry.
 - Connect low-ESR, 0.1- μ F ceramic bypass capacitors between each supply pin and ground, placed as close to the device as possible. A single bypass capacitor from V+ to ground is applicable for single-supply applications.
- Separate grounding for analog and digital portions of the circuitry is one of the simplest and most effective methods of noise suppression. One or more layers on multilayer PCBs are usually devoted to ground planes. A ground plane helps distribute heat and reduces EMI noise pickup. Make sure to physically separate digital and analog grounds, paying attention to the flow of the ground current. For more detailed information, see [SLOA089](#), *Circuit Board Layout Techniques*.
- In order to reduce parasitic coupling, run the input traces as far away from the supply or output traces as possible. If these traces cannot be kept separate, crossing the sensitive trace perpendicular is much better than in parallel with the noisy trace.
- Place the external components as close to the device as possible. As illustrated in [Figure 57](#), keeping R_G close to the pins minimizes parasitic capacitance.
- Keep the traces as short as possible.

10.2 Layout Example

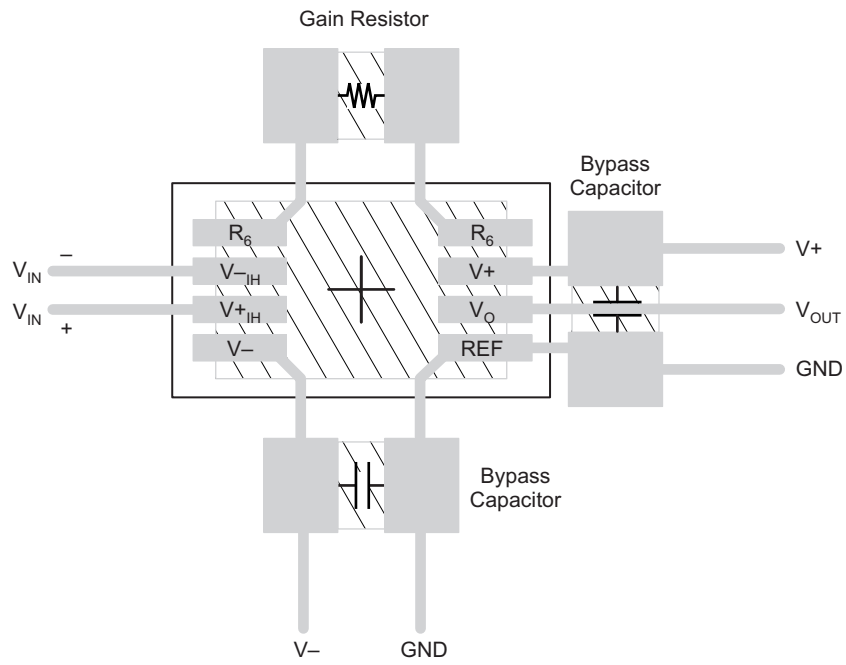

Figure 57. PCB Layout Example

11 器件和文档支持

11.1 器件支持

11.1.1 开发支持

表 4. 表 1.设计套件与评估模块

名称	部件号	类型
DIP 适配器评估模块	DIP-ADAPTER-EVM	评估模块和评估板
通用仪表放大器评估模块	INAEVM	评估模块和评估板

表 5. 表 2.开发工具

名称	部件号	类型
计算器放大器的输入共模范围	INA-CMV-CALC	计算工具
基于 SPICE 的模拟仿真程序	TINA-TI	电路设计和仿真

11.2 文档支持

11.2.1 相关文档

《OPA188 数据表》，[SBOS642](#)

《OPA330 数据表》，[SBOS432](#)

《REF3225 数据表》，[SBVS058](#)

《电路板布局布线技巧》，[SLOA089](#)

11.3 社区资源

The following links connect to TI community resources. Linked contents are provided "AS IS" by the respective contributors. They do not constitute TI specifications and do not necessarily reflect TI's views; see TI's [Terms of Use](#).

TI E2E™ Online Community *TI's Engineer-to-Engineer (E2E) Community*. Created to foster collaboration among engineers. At e2e.ti.com, you can ask questions, share knowledge, explore ideas and help solve problems with fellow engineers.

Design Support *TI's Design Support* Quickly find helpful E2E forums along with design support tools and contact information for technical support.

11.4 商标

E2E is a trademark of Texas Instruments.

Bluetooth is a registered trademark of Bluetooth SIG, Inc.

PhotoMOS is a registered trademark of Panasonic Electric Works Europe AG.

All other trademarks are the property of their respective owners.

11.5 静电放电警告



这些装置包含有限的内置 ESD 保护。存储或装卸时，应将导线一起截短或将装置放置于导电泡棉中，以防止 MOS 门极遭受静电损伤。

11.6 Glossary

[SLYZ022](#) — *TI Glossary*.

This glossary lists and explains terms, acronyms, and definitions.

12 机械、封装和可订购信息

以下页中包括机械、封装和可订购信息。 这些信息是针对指定器件可提供的最新数据。 这些数据会在无通知且不对本文档进行修订的情况下发生改变。 欲获得该数据表的浏览器版本，请查阅左侧的导航栏。

重要声明

德州仪器(TI)及其下属子公司有权根据 JESD46 最新标准,对所提供的产品和服务进行更正、修改、增强、改进或其它更改,并有权根据 JESD48 最新标准中止提供任何产品和服务。客户在下订单前应获取最新的相关信息,并验证这些信息是否完整且是最新的。所有产品的销售都遵循在订单确认时所提供的TI 销售条款与条件。

TI 保证其所销售的组件的性能符合产品销售时 TI 半导体产品销售条件与条款的适用规范。仅在 TI 保证的范围内,且 TI 认为有必要时才会使用测试或其它质量控制技术。除非适用法律做出了硬性规定,否则没有必要对每种组件的所有参数进行测试。

TI 对应用帮助或客户产品设计不承担任何义务。客户应对其使用 TI 组件的产品和应用自行负责。为尽量减小与客户产品和应用相关的风险,客户应提供充分的设计与操作安全措施。

TI 不对任何 TI 专利权、版权、屏蔽作品权或其它与使用了 TI 组件或服务的组合设备、机器或流程相关的 TI 知识产权中授予的直接或隐含权限作出任何保证或解释。TI 所发布的与第三方产品或服务有关的信息,不能构成从 TI 获得使用这些产品或服务的许可、授权、或认可。使用此类信息可能需要获得第三方的专利权或其它知识产权方面的许可,或是 TI 的专利权或其它知识产权方面的许可。

对于 TI 的产品手册或数据表中 TI 信息的重要部分,仅在没有对内容进行任何篡改且带有相关授权、条件、限制和声明的情况下才允许进行复制。TI 对此类篡改过的文件不承担任何责任或义务。复制第三方的信息可能需要服从额外的限制条件。

在转售 TI 组件或服务时,如果对该组件或服务参数的陈述与 TI 标明的参数相比存在差异或虚假成分,则会失去相关 TI 组件或服务的所有明示或暗示授权,且这是不正当的、欺诈性商业行为。TI 对任何此类虚假陈述均不承担任何责任或义务。

客户认可并同意,尽管任何应用相关信息或支持仍可能由 TI 提供,但他们将独立负责满足与其产品及其在应用中使用的 TI 产品相关的所有法律、法规和安全相关要求。客户声明并同意,他们具备制定与实施安全措施所需的全部专业技术和知识,可预见故障的危险后果、监测故障及其后果、降低有可能造成人身伤害的故障的发生机率并采取适当的补救措施。客户将全额赔偿因在此类安全关键应用中使用任何 TI 组件而对 TI 及其代理造成的任何损失。

在某些场合中,为了推进安全相关应用有可能对 TI 组件进行特别的促销。TI 的目标是利用此类组件帮助客户设计和创立其特有的可满足适用的功能安全性标准和要求的终端产品解决方案。尽管如此,此类组件仍然服从这些条款。

TI 组件未获得用于 FDA Class III (或类似的生命攸关医疗设备)的授权许可,除非各方授权官员已经达成了专门管控此类使用的特别协议。

只有那些 TI 特别注明属于军用等级或“增强型塑料”的 TI 组件才是设计或专门用于军事/航空应用或环境的。购买者认可并同意,对并非指定面向军事或航空航天用途的 TI 组件进行军事或航空航天方面的应用,其风险由客户单独承担,并且由客户独立负责满足与此类使用相关的所有法律和法规要求。

TI 已明确指定符合 ISO/TS16949 要求的产品,这些产品主要用于汽车。在任何情况下,因使用非指定产品而无法达到 ISO/TS16949 要求, TI 不承担任何责任。

	产品		应用
数字音频	www.ti.com.cn/audio	通信与电信	www.ti.com.cn/telecom
放大器和线性器件	www.ti.com.cn/amplifiers	计算机及周边	www.ti.com.cn/computer
数据转换器	www.ti.com.cn/dataconverters	消费电子	www.ti.com.cn/consumer-apps
DLP® 产品	www.dlp.com	能源	www.ti.com.cn/energy
DSP - 数字信号处理器	www.ti.com.cn/dsp	工业应用	www.ti.com.cn/industrial
时钟和计时器	www.ti.com.cn/clockandtimers	医疗电子	www.ti.com.cn/medical
接口	www.ti.com.cn/interface	安防应用	www.ti.com.cn/security
逻辑	www.ti.com.cn/logic	汽车电子	www.ti.com.cn/automotive
电源管理	www.ti.com.cn/power	视频和影像	www.ti.com.cn/video
微控制器 (MCU)	www.ti.com.cn/microcontrollers		
RFID 系统	www.ti.com.cn/rfidsys		
OMAP应用处理器	www.ti.com/omap		
无线连通性	www.ti.com.cn/wirelessconnectivity	德州仪器在线技术支持社区	www.deyisupport.com

邮寄地址: 上海市浦东新区世纪大道1568号, 中建大厦32楼邮政编码: 200122
Copyright © 2015, 德州仪器半导体技术(上海)有限公司

PACKAGING INFORMATION

Orderable Device	Status (1)	Package Type	Package Drawing	Pins	Package Qty	Eco Plan (2)	Lead finish/ Ball material (6)	MSL Peak Temp (3)	Op Temp (°C)	Device Marking (4/5)	Samples
INA188ID	ACTIVE	SOIC	D	8	75	RoHS & Green	NIPDAU	Level-2-260C-1 YEAR	-40 to 125	INA188	Samples
INA188IDR	ACTIVE	SOIC	D	8	2500	RoHS & Green	NIPDAU	Level-2-260C-1 YEAR	-40 to 125	INA188	Samples
INA188IDRJR	ACTIVE	SON	DRJ	8	1000	RoHS & Green	NIPDAU	Level-2-260C-1 YEAR	-40 to 125	INA188	Samples

(1) The marketing status values are defined as follows:

ACTIVE: Product device recommended for new designs.

LIFEBUY: TI has announced that the device will be discontinued, and a lifetime-buy period is in effect.

NRND: Not recommended for new designs. Device is in production to support existing customers, but TI does not recommend using this part in a new design.

PREVIEW: Device has been announced but is not in production. Samples may or may not be available.

OBSOLETE: TI has discontinued the production of the device.

(2) **RoHS:** TI defines "RoHS" to mean semiconductor products that are compliant with the current EU RoHS requirements for all 10 RoHS substances, including the requirement that RoHS substance do not exceed 0.1% by weight in homogeneous materials. Where designed to be soldered at high temperatures, "RoHS" products are suitable for use in specified lead-free processes. TI may reference these types of products as "Pb-Free".

RoHS Exempt: TI defines "RoHS Exempt" to mean products that contain lead but are compliant with EU RoHS pursuant to a specific EU RoHS exemption.

Green: TI defines "Green" to mean the content of Chlorine (Cl) and Bromine (Br) based flame retardants meet JS709B low halogen requirements of <=1000ppm threshold. Antimony trioxide based flame retardants must also meet the <=1000ppm threshold requirement.

(3) MSL, Peak Temp. - The Moisture Sensitivity Level rating according to the JEDEC industry standard classifications, and peak solder temperature.

(4) There may be additional marking, which relates to the logo, the lot trace code information, or the environmental category on the device.

(5) Multiple Device Markings will be inside parentheses. Only one Device Marking contained in parentheses and separated by a "~" will appear on a device. If a line is indented then it is a continuation of the previous line and the two combined represent the entire Device Marking for that device.

(6) Lead finish/Ball material - Orderable Devices may have multiple material finish options. Finish options are separated by a vertical ruled line. Lead finish/Ball material values may wrap to two lines if the finish value exceeds the maximum column width.

Important Information and Disclaimer:The information provided on this page represents TI's knowledge and belief as of the date that it is provided. TI bases its knowledge and belief on information provided by third parties, and makes no representation or warranty as to the accuracy of such information. Efforts are underway to better integrate information from third parties. TI has taken and continues to take reasonable steps to provide representative and accurate information but may not have conducted destructive testing or chemical analysis on incoming materials and chemicals. TI and TI suppliers consider certain information to be proprietary, and thus CAS numbers and other limited information may not be available for release.

In no event shall TI's liability arising out of such information exceed the total purchase price of the TI part(s) at issue in this document sold by TI to Customer on an annual basis.

DRJ (S-PWSON-N8)

PLASTIC SMALL OUTLINE NO-LEAD

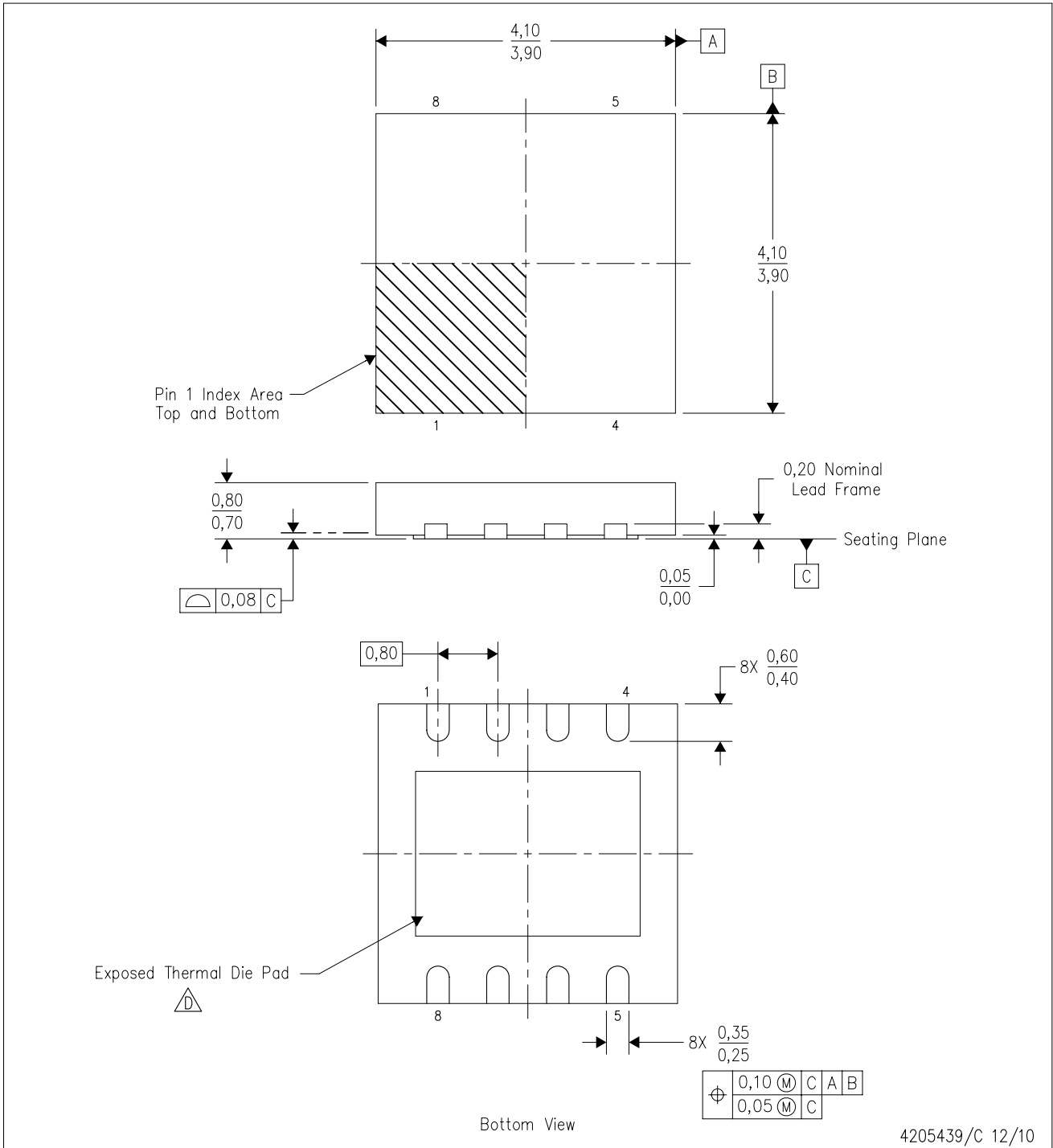

4205439/C 12/10

- NOTES:
- A. All linear dimensions are in millimeters. Dimensioning and tolerancing per ASME Y14.5M-1994.
 - B. This drawing is subject to change without notice.
 - C. SON (Small Outline No-Lead) package configuration.
 -  The package thermal pad must be soldered to the board for thermal and mechanical performance. See the Product Data Sheet for details regarding the exposed thermal pad dimensions.
 - E. Package complies to JEDEC MO-229 variation WGGB.

THERMAL PAD MECHANICAL DATA

DRJ (S-PWSON-N8)

PLASTIC SMALL OUTLINE NO-LEAD

THERMAL INFORMATION

This package incorporates an exposed thermal pad that is designed to be attached directly to an external heatsink. The thermal pad must be soldered directly to the printed circuit board (PCB). After soldering, the PCB can be used as a heatsink. In addition, through the use of thermal vias, the thermal pad can be attached directly to the appropriate copper plane shown in the electrical schematic for the device, or alternatively, can be attached to a special heatsink structure designed into the PCB. This design optimizes the heat transfer from the integrated circuit (IC).

For information on the Quad Flatpack No-Lead (QFN) package and its advantages, refer to Application Report, QFN/SON PCB Attachment, Texas Instruments Literature No. SLUA271. This document is available at www.ti.com.

The exposed thermal pad dimensions for this package are shown in the following illustration.

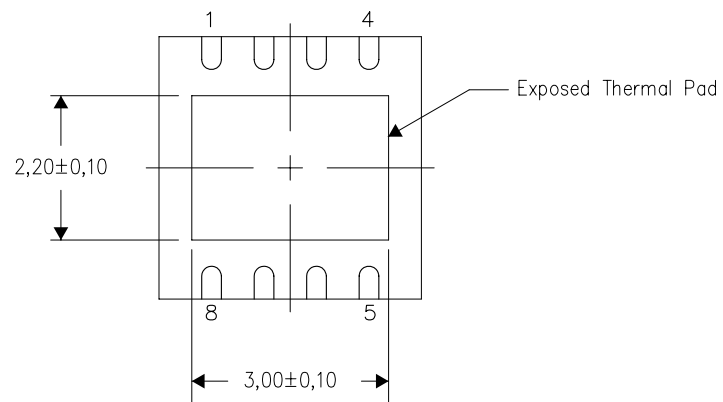

Bottom View

Exposed Thermal Pad Dimensions

4206882/F 01/11

NOTE: All linear dimensions are in millimeters

DRJ (S-PWSON-N8)

SMALL PACKAGE OUTLINE NO-LEAD

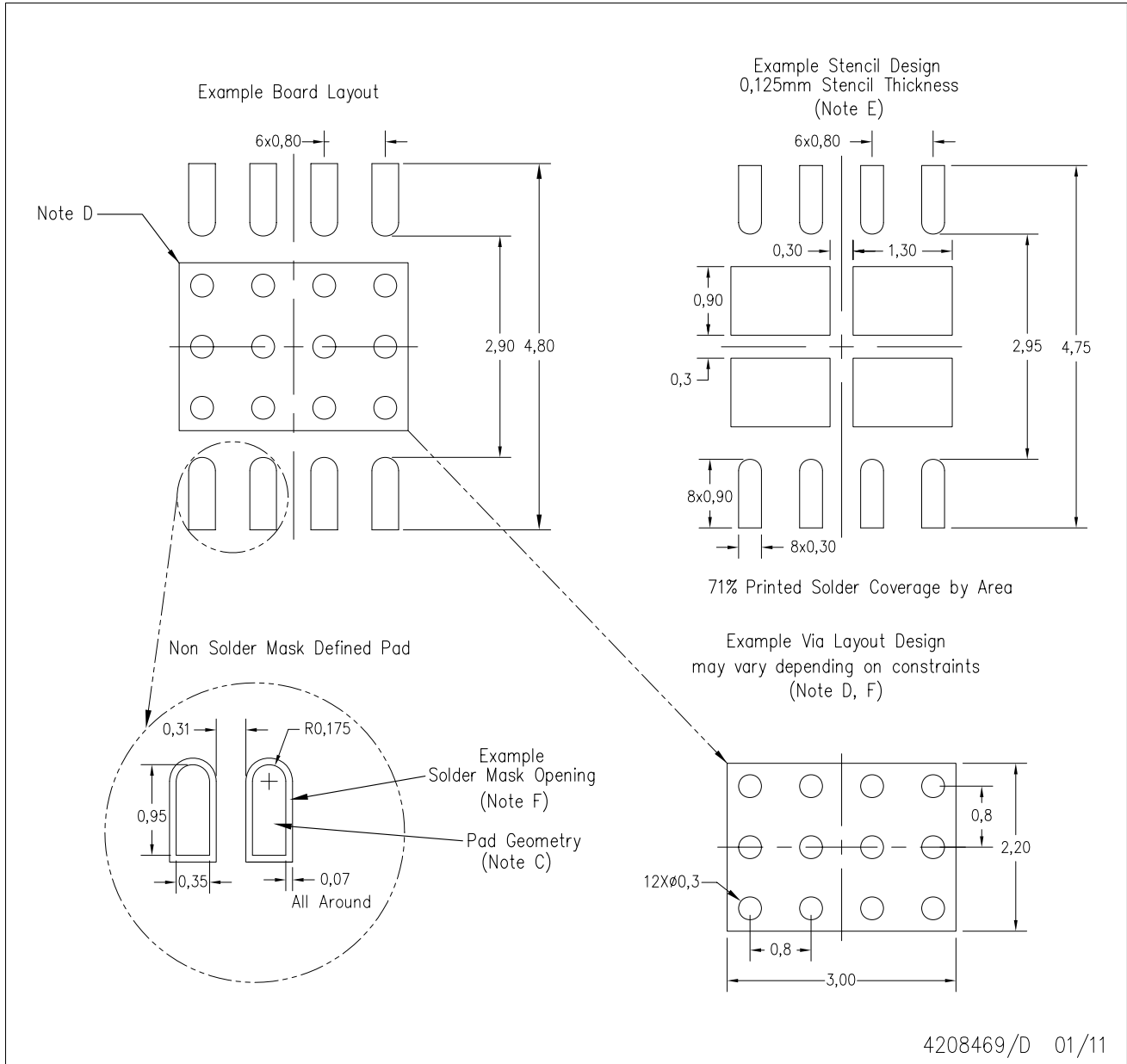

- NOTES:
- A. All linear dimensions are in millimeters.
 - B. This drawing is subject to change without notice.
 - C. Publication IPC-7351 is recommended for alternate designs.
 - D. This package is designed to be soldered to a thermal pad on the board. Refer to Application Note, Quad Flat-Pack Packages, Texas Instruments Literature No. SLUA271, and also the Product Data Sheets for specific thermal information, via requirements, and recommended board layout. These documents are available at www.ti.com <<http://www.ti.com>>.
 - E. Laser cutting apertures with electropolish and also rounding corners will offer better paste release. Customers should contact their board assembly site for stencil design recommendations. Refer to IPC 7525 for stencil design considerations.
 - F. Customers should contact their board fabrication site for solder mask tolerances and vias tenting recommendations for vias placed in the thermal pad.



D0008A

PACKAGE OUTLINE

SOIC - 1.75 mm max height

SMALL OUTLINE INTEGRATED CIRCUIT



4214825/C 02/2019

NOTES:

1. Linear dimensions are in inches [millimeters]. Dimensions in parenthesis are for reference only. Controlling dimensions are in inches. Dimensioning and tolerancing per ASME Y14.5M.
2. This drawing is subject to change without notice.
3. This dimension does not include mold flash, protrusions, or gate burrs. Mold flash, protrusions, or gate burrs shall not exceed .006 [0.15] per side.
4. This dimension does not include interlead flash.
5. Reference JEDEC registration MS-012, variation AA.

EXAMPLE BOARD LAYOUT

D0008A

SOIC - 1.75 mm max height

SMALL OUTLINE INTEGRATED CIRCUIT



LAND PATTERN EXAMPLE
EXPOSED METAL SHOWN
SCALE:8X



SOLDER MASK DETAILS

4214825/C 02/2019

NOTES: (continued)

6. Publication IPC-7351 may have alternate designs.

7. Solder mask tolerances between and around signal pads can vary based on board fabrication site.

EXAMPLE STENCIL DESIGN

D0008A

SOIC - 1.75 mm max height

SMALL OUTLINE INTEGRATED CIRCUIT



SOLDER PASTE EXAMPLE
BASED ON .005 INCH [0.125 MM] THICK STENCIL
SCALE:8X

4214825/C 02/2019

NOTES: (continued)

8. Laser cutting apertures with trapezoidal walls and rounded corners may offer better paste release. IPC-7525 may have alternate design recommendations.
9. Board assembly site may have different recommendations for stencil design.

重要声明和免责声明

TI 均以“原样”提供技术性及其可靠性数据（包括数据表）、设计资源（包括参考设计）、应用或其他设计建议、网络工具、安全信息和其他资源，不保证其中不含任何瑕疵，且不做任何明示或暗示的担保，包括但不限于对适销性、适合某特定用途或不侵犯任何第三方知识产权的暗示担保。

所述资源可供专业开发人员应用TI 产品进行设计使用。您将对以下行为独自承担全部责任：(1) 针对您的应用选择合适的TI 产品；(2) 设计、验证并测试您的应用；(3) 确保您的应用满足相应标准以及任何其他安全、安保或其他要求。所述资源如有变更，恕不另行通知。TI 对您使用所述资源的授权仅限于开发资源所涉及TI 产品的相关应用。除此之外不得复制或展示所述资源，也不提供其它TI 或任何第三方的知识产权授权许可。如因使用所述资源而产生任何索赔、赔偿、成本、损失及债务等，TI 对此概不负责，并且您须赔偿由此对TI 及其代表造成的损害。

TI 所提供产品均受TI 的销售条款 (<http://www.ti.com.cn/zh-cn/legal/termsofsale.html>) 以及ti.com.cn 上或随附TI 产品提供的其他可适用条款的约束。TI 提供所述资源并不扩展或以其他方式更改TI 针对TI 产品所发布的可适用的担保范围或担保免责声明。

邮寄地址：上海市浦东新区世纪大道 1568 号中建大厦 32 楼，邮政编码：200122

Copyright © 2020 德州仪器半导体技术（上海）有限公司

X-ON Electronics

Largest Supplier of Electrical and Electronic Components

Click to view similar products for [Instrumentation Amplifiers](#) category:

Click to view products by [Texas Instruments](#) manufacturer:

Other Similar products are found below :

[ISL28274FAZ](#) [INA350ABSIDSGR](#) [HT8620ARZ](#) [TPA1286-SO1R](#) [AD624AD/+](#) [RS633EHXM](#) [SGM620XS8G/TR](#) [INA848IDR](#)
[INA351AIDSGR](#) [AD620RX](#) [ADA4530-1ARZ-RL](#) [AD8421ARMZ-RL](#) [TPA1286-VS1R](#) [MCP6N16-100EMF](#) [JM38510/13501BGA](#)
[MCP6N16-001E/MF](#) [AD8422BRMZ-R7](#) [AD8426BCPZ-R7](#) [INA188IDRJR](#) [AD8220BRMZ-R7](#) [LTC1100CN8#PBF](#) [INA333AIDGKRG4](#)
[INA826SIDRCT](#) [INA826SIDRCR](#) [AD8221ARMZ](#) [AD8226ARZ-RL](#) [AD694JN](#) [AD8420ARMZ-RL](#) [AD620ANZ](#) [AD621BR](#) [AD622ANZ](#)
[AD623ANZ](#) [AD623BNZ](#) [AD625BDZ](#) [AD694JNZ](#) [AD620SQ/883B](#) [AD8220ARMZ-R7](#) [AD8220WARMZ](#) [AD8221ARMZ-R7](#)
[AD8224ACPZ-R7](#) [AD8222ACPZ-R7](#) [AD8222ACPZ-RL](#) [AD8223ARMZ-R7](#) [AD8222HACPZ-R7](#) [AD8226ARMZ](#) [AD8228ARMZ-R7](#)
[AD8236ARMZ-R7](#) [AD8237ARMZ](#) [AD8237ARMZ-R7](#) [AD8250ARMZ](#)