

# LM4915 Boomer<sup>®</sup> Audio Power Amplifier Series **Pseudo-Differential Mono Headphone Amplifier with Fixed 6dB Gain**

Check for Samples: [LM4915](#)

## FEATURES

- Pseudo-Differential Amplification
- Internal Gain-Setting Resistors
- Available in Space-Saving WQFN Package
- Ultra Low Current Shutdown Mode
- Can Drive Capacitive Loads up to 500pF
- Improved Pop & Click Circuitry Virtually Eliminates Noises During Turn-On and Turn-Off Transitions
- 2.2 - 5.5V Operation
- No Output Coupling Capacitors, Snubber Networks, Bootstrap Capacitors or Gain-Setting Resistors Required
- Ultra Low Noise

## KEY SPECIFICATIONS

- Improved PSRR at 217Hz and 1kHz: 75dB (Typ)
- Power Output at 5.0V & 1% THD into 32Ω: 280mW (Typ)
- Power Output at 3.0V & 1% THD into 32Ω: 90mW (Typ)
- Output Noise, A-weighted: 20μV (Typ)

## APPLICATIONS

- Mobile Phones
- PDAs
- Portable Electronics Devices

## DESCRIPTION

The LM4915 is a pseudo-differential audio power amplifier primarily designed for demanding applications in mobile phones and other portable audio device applications with mono headphones. It is capable of delivering 90 milliwatts of continuous average power to a 32Ω BTL load with less than 1% distortion (THD+N) from a 3V<sub>DC</sub> power supply.

Boomer audio power amplifiers were designed specifically to provide high quality output power with a minimal amount of external components. The LM4915 does not require output coupling capacitors or bootstrap capacitors, and therefore is ideally suited for mobile phone and other low voltage applications where minimal power consumption is a primary requirement.

The LM4915 features a low-power consumption shutdown mode. To facilitate this, Shutdown may be enabled by driving the shutdown pin low. Additionally, the LM4915 features an internal thermal shutdown protection mechanism.

The LM4915 contains advanced pop & click circuitry which virtually eliminates noises which would otherwise occur during turn-on and turn-off transitions.

The LM4915 has an internally fixed gain of 6dB.



Please be aware that an important notice concerning availability, standard warranty, and use in critical applications of Texas Instruments semiconductor products and disclaimers thereto appears at the end of this data sheet.

All trademarks are the property of their respective owners.

Typical Application

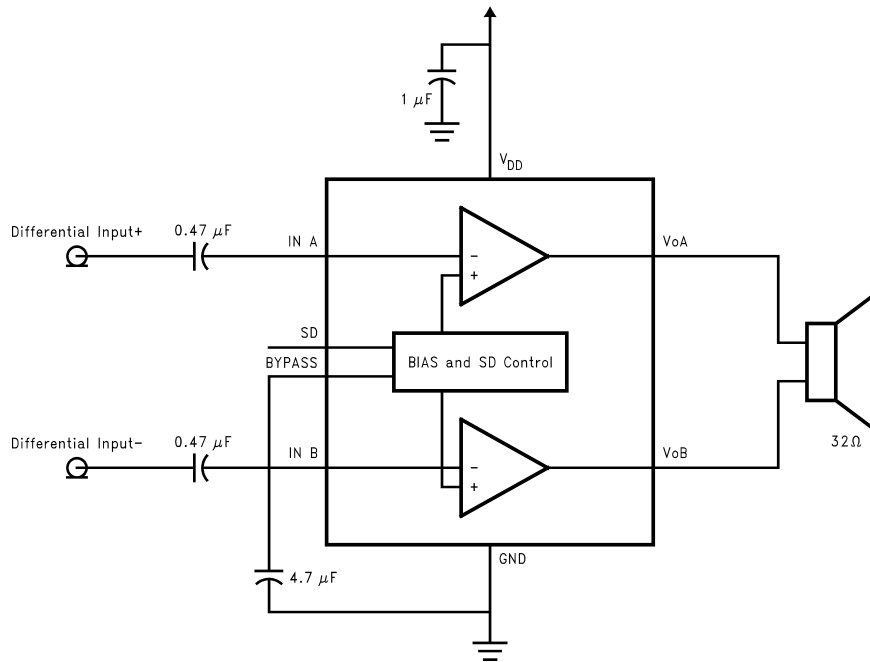

Figure 1. Typical Audio Amplifier Application Circuit

Connection Diagrams

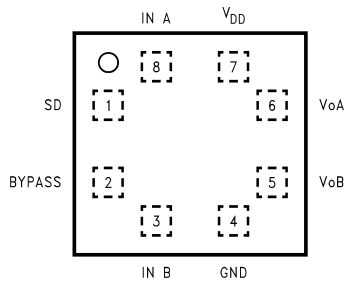

Figure 2. WQFN Package – Top View  
See Package Number NGP0008A



These devices have limited built-in ESD protection. The leads should be shorted together or the device placed in conductive foam during storage or handling to prevent electrostatic damage to the MOS gates.

### Absolute Maximum Ratings<sup>(1)(2)</sup>

Supply Voltage		6.0V
Storage Temperature		-65°C to +150°C
Input Voltage		-0.3V to $V_{DD} + 0.3V$
Power Dissipation <sup>(3)</sup>		Internally Limited
ESD Susceptibility	Human Body Model <sup>(4)</sup>	2000V
	Machine Model <sup>(5)</sup>	200V
Junction Temperature		150°C
Thermal Resistance	$\theta_{JC}$ (WQFN)	57°C/W
	$\theta_{JA}$ (WQFN)	140°C/W

- (1) Absolute Maximum Ratings indicate limits beyond which damage to the device may occur. [Operating Ratings](#) indicate conditions for which the device is functional but do not ensure specific performance limits. Electrical Characteristics state DC and AC electrical specifications under particular test conditions which ensure specific performance limits. This assumes that the device is within the Operating Ratings. Specifications are not ensured for parameters where no limit is given, however, the typical value is a good indication of device performance.
- (2) If Military/Aerospace specified devices are required, please contact the Texas Instruments Sales Office/ Distributors for availability and specifications.
- (3) The maximum power dissipation must be derated at elevated temperatures and is dictated by  $T_{JMAX}$ ,  $\theta_{JA}$ , and the ambient temperature,  $T_A$ . The maximum allowable power dissipation is  $P_{DMAX} = (T_{JMAX} - T_A) / \theta_{JA}$  or the number given in Absolute Maximum Ratings, whichever is lower. For the LM4915, see power derating curves for more information.
- (4) Human body model, 100pF discharged through a 1.5k $\Omega$  resistor.
- (5) Machine Model, 220pF-240pF discharged through all pins.

### Operating Ratings

Temperature Range ( $T_{MIN} \leq T_A \leq T_{MAX}$ )	$-40^\circ\text{C} \leq T_A \leq +85^\circ\text{C}$
Supply Voltage ( $V_{DD}$ )	$2.2V \leq V_{CC} \leq 5.5V$

## Electrical Characteristics $V_{DD} = 5V^{(1)(2)(3)}$

The following specifications apply for  $V_{DD} = 5V$ ,  $R_L = 16\Omega$  unless otherwise specified. Limits apply to  $T_A = 25^\circ C$ .

Symbol	Parameter	Conditions	LM4915		Units (Limits)
			Typ <sup>(4)</sup>	Limit <sup>(5)</sup>	
$I_{DD}$	Quiescent Power Supply Current	$V_{IN} = 0V$ , $I_O = 0A$	2	3.5	mA (max)
$I_{SD}$	Shutdown Current	$V_{SHUTDOWN} = GND$	0.1	See <sup>(6)</sup>	$\mu A$ (max)
$V_{SDIH}$	Shutdown Voltage Input High		1.8		V
$V_{SDIL}$	Shutdown Voltage Input Low		0.4		V
$P_O$	Output Power	THD = 1% (max); f = 1kHz $R_L = 16$ $R_L = 32$	400 280	375 250	mW
$V_{NO}$	Output Noise Voltage	BW = 20Hz to 20kHz, A-weighted	20		$\mu V$
PSRR	Power Supply Rejection Ratio	$V_{RIPPLE} = 200mV$ sine p-p	75		dB
$V_{OS}$	Output Offset Voltage	$V_{IN} = 0V$	2	20	mV (max)

- (1) All voltages are measured with respect to the GND pin unless otherwise specified.
- (2) Absolute Maximum Ratings indicate limits beyond which damage to the device may occur. [Operating Ratings](#) indicate conditions for which the device is functional but do not ensure specific performance limits. Electrical Characteristics state DC and AC electrical specifications under particular test conditions which ensure specific performance limits. This assumes that the device is within the Operating Ratings. Specifications are not ensured for parameters where no limit is given, however, the typical value is a good indication of device performance.
- (3) Datasheet min/max specifications are specified by design, test, or statistical analysis.
- (4) Typicals are measured at  $25^\circ C$  and represent the parametric norm.
- (5) Limits are specified to AOQL (Average Outgoing Quality Level).
- (6) See  $I_{SD}$  distribution values shown in the  $I_{SD}$  Distribution curves,  $V_{DD} = 5V$  and  $V = 3V$ , ([Figure 29](#) and [Figure 30](#), respectively) shown in the [Typical Performance Characteristics](#) section.

## Electrical Characteristics $V_{DD} = 3.0V^{(1)(2)(3)}$

The following specifications apply for  $V_{DD} = 3.0V$ ,  $R_L = 16\Omega$  unless otherwise specified. Limits apply to  $T_A = 25^\circ C$ .

Symbol	Parameter	Conditions	LM4915		Units (Limits)
			Typ <sup>(4)</sup>	Limit <sup>(5)</sup>	
$I_{DD}$	Quiescent Power Supply Current	$V_{IN} = 0V$ , $I_O = 0A$	1.5	2.5	mA (max)
$I_{SD}$	Shutdown Current	$V_{SHUTDOWN} = GND$	0.1	See <sup>(6)</sup>	$\mu A$ (max)
$V_{SDIH}$	Shutdown Voltage Input High		1.8		V
$V_{SDIL}$	Shutdown Voltage Input Low		0.4		V
$P_O$	Output Power	THD = 1% (max); f = 1kHz $R_L = 16$ $R_L = 32$	125 90	100 80	mW (min)
$V_{NO}$	Output Noise Voltage	BW = 20Hz to 20kHz, A-weighted	20		$\mu V$
PSRR	Power Supply Rejection Ratio	$V_{RIPPLE} = 200mV$ sine p-p	70		dB
$V_{OS}$	Output Offset Voltage	$V_{IN} = 0V$	2	20	mV (max)

- (1) All voltages are measured with respect to the GND pin unless otherwise specified.
- (2) Absolute Maximum Ratings indicate limits beyond which damage to the device may occur. [Operating Ratings](#) indicate conditions for which the device is functional but do not ensure specific performance limits. Electrical Characteristics state DC and AC electrical specifications under particular test conditions which ensure specific performance limits. This assumes that the device is within the Operating Ratings. Specifications are not ensured for parameters where no limit is given, however, the typical value is a good indication of device performance.
- (3) Datasheet min/max specifications are specified by design, test, or statistical analysis.
- (4) Typical values are measured at  $25^\circ C$  and represent the parametric norm.
- (5) Limits are specified to AOQL (Average Outgoing Quality Level).
- (6) See  $I_{SD}$  distribution values shown in the  $I_{SD}$  Distribution curves,  $V_{DD} = 5V$  and  $V = 3V$ , ([Figure 29](#) and [Figure 30](#), respectively) shown in the [Typical Performance Characteristics](#) section.

## External Components Description

([Figure 1](#))

Components		Functional Description
1.	$C_B$	Bypass pin capacitor that provides half-supply filtering. Refer to the section <a href="#">Proper Selection of External Components</a> for information concerning proper placement and selection of $C_B$ .
2.	$C_i$	Input coupling capacitor which blocks the DC voltage at the amplifier's input terminals. Also creates a high-pass filter with the internal input resistance $R_i$ . For the LM4915, $R_i = 20k\Omega$ , thus creating a high-pass filter $f_c = 1/(2\pi R_i C_i)$ . Refer to the section <a href="#">Proper Selection of External Components</a> for an explanation of how to determine the value of $C_i$ .

### Typical Performance Characteristics

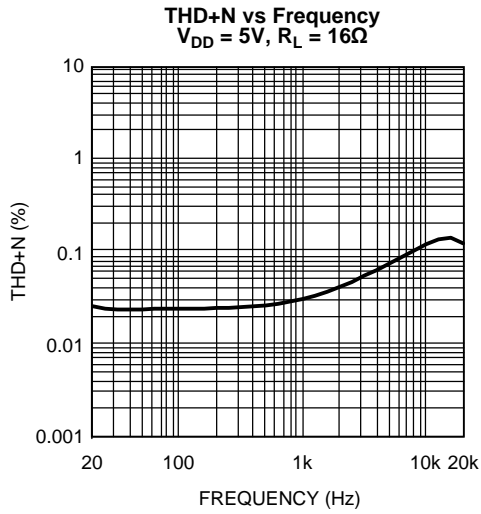

Figure 3.

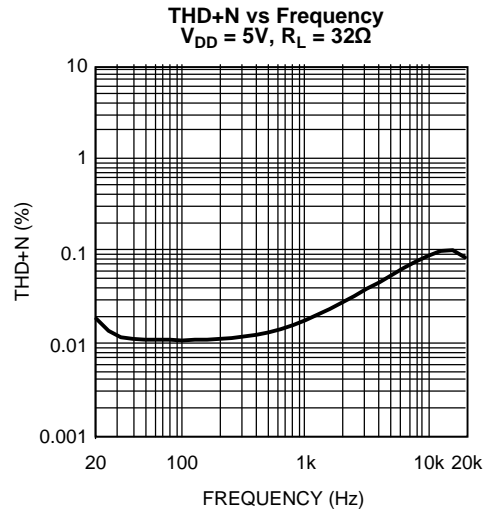

Figure 4.

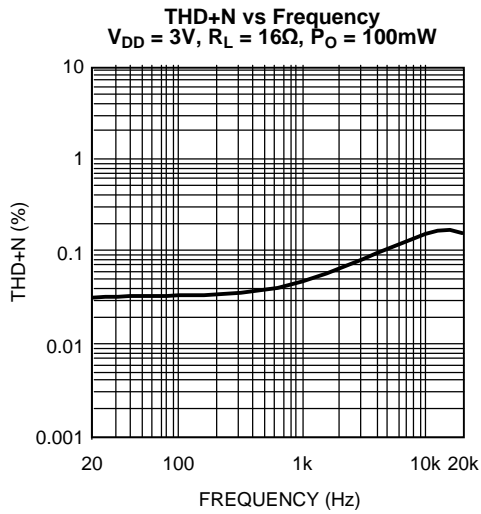

Figure 5.

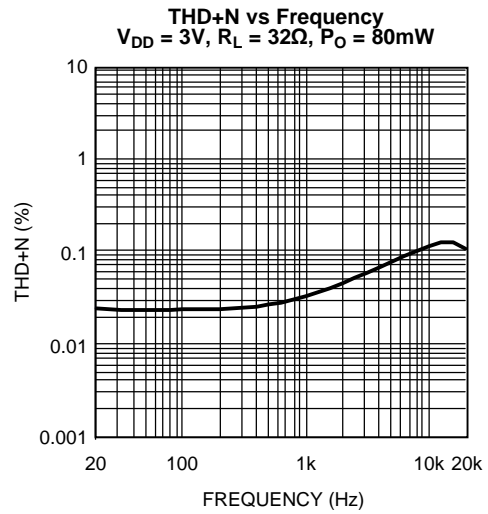

Figure 6.

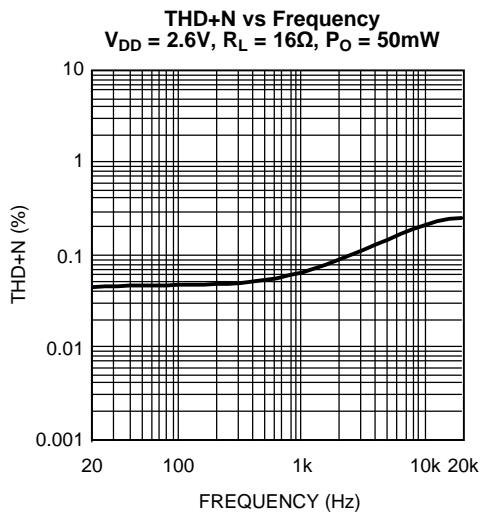

Figure 7.

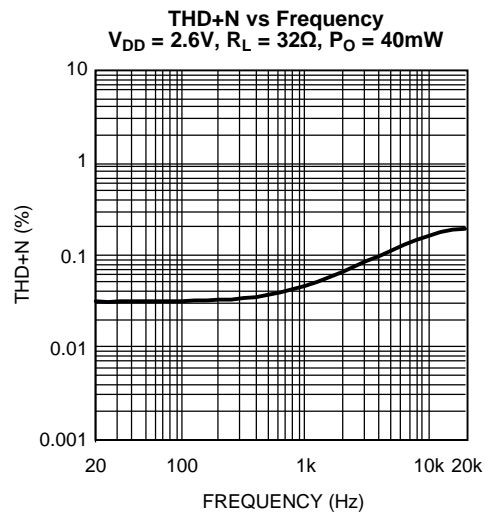

Figure 8.

Typical Performance Characteristics (continued)

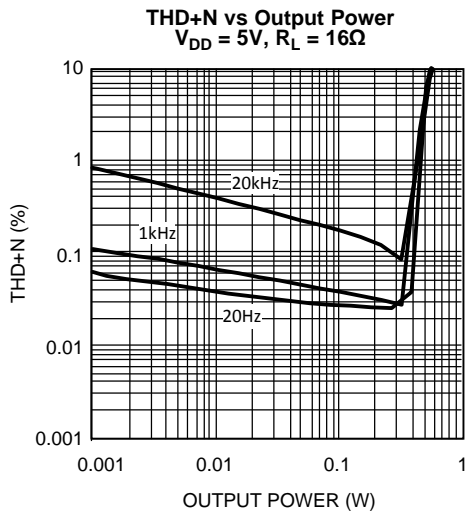

Figure 9.

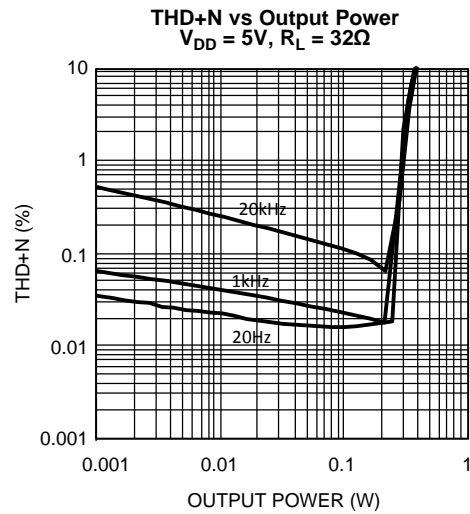

Figure 10.

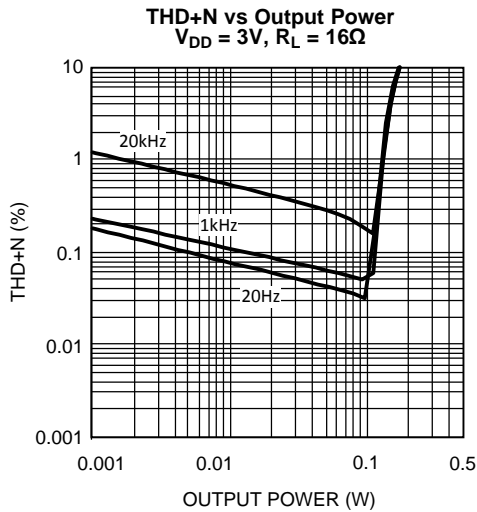

Figure 11.

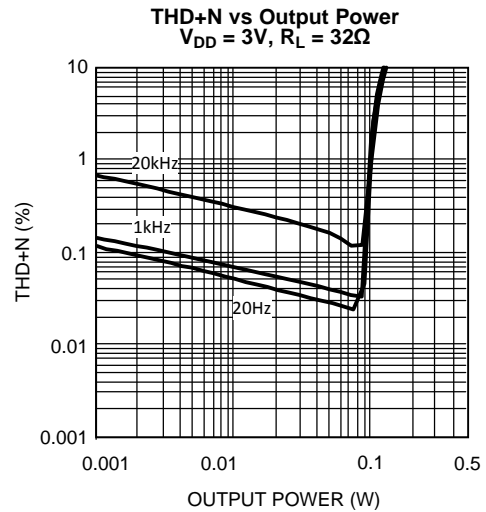

Figure 12.

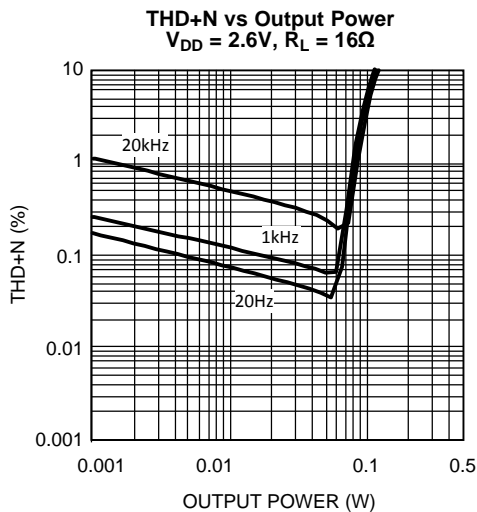

Figure 13.

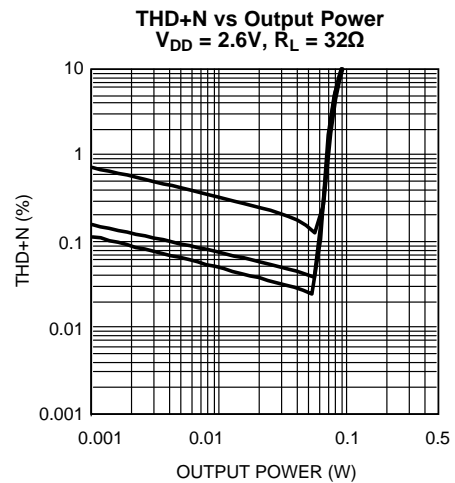

Figure 14.

Typical Performance Characteristics (continued)

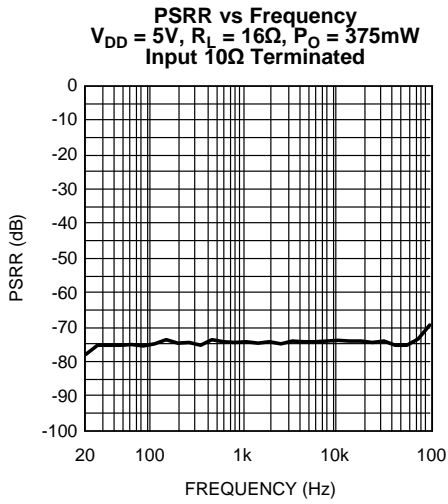

Figure 15.

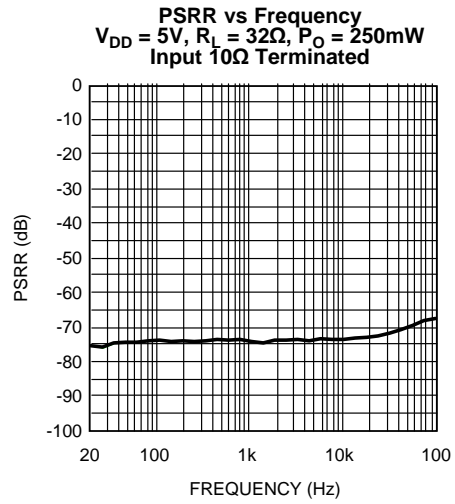

Figure 16.

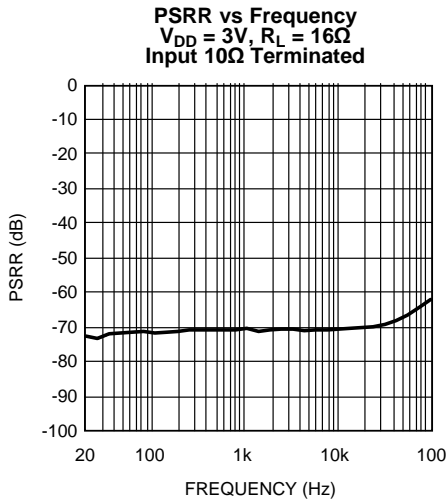

Figure 17.

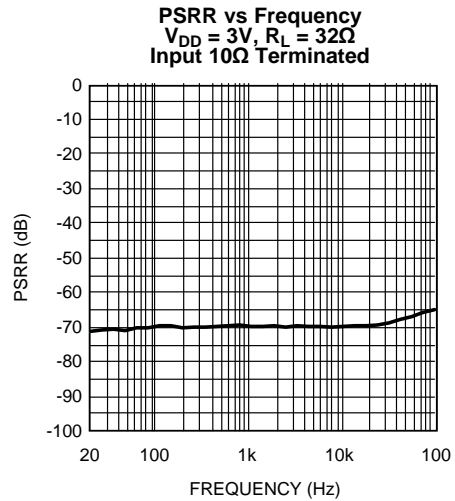

Figure 18.

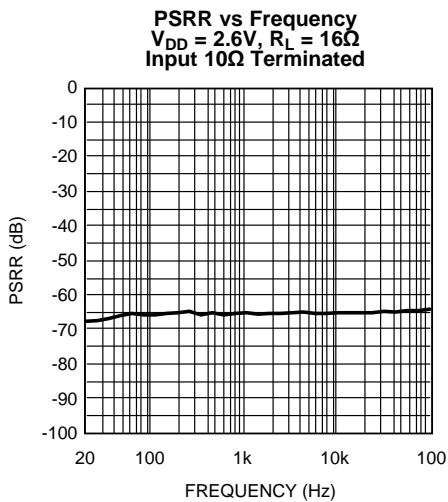

Figure 19.

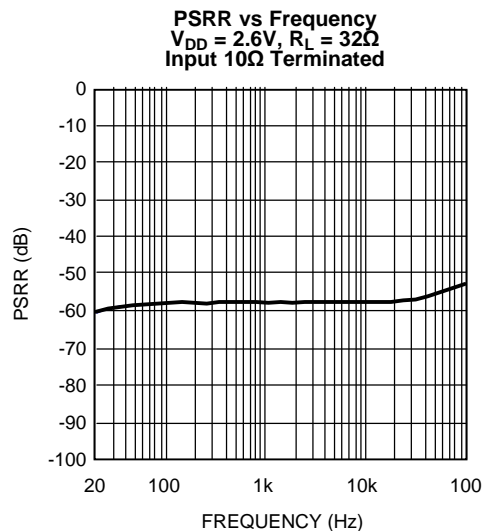

Figure 20.



Typical Performance Characteristics (continued)

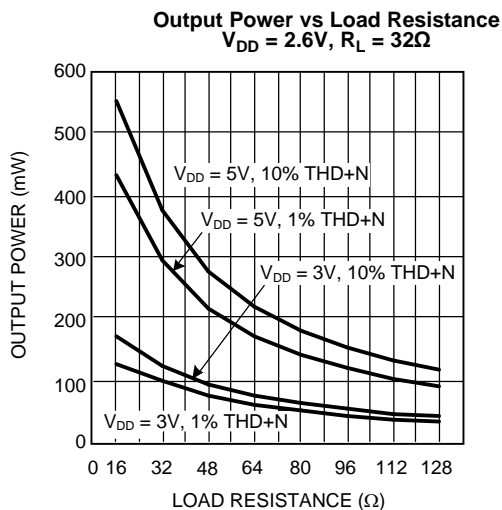

Figure 21.

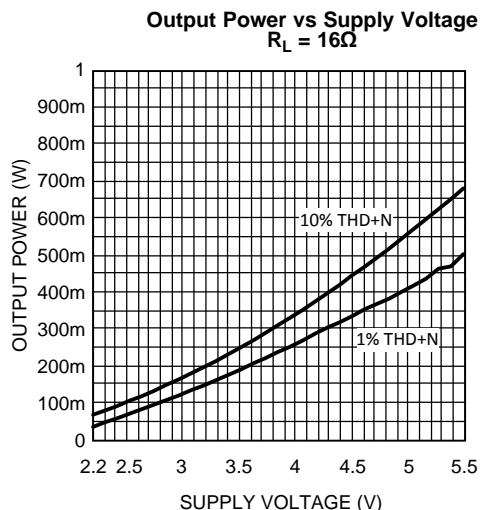

Figure 22.

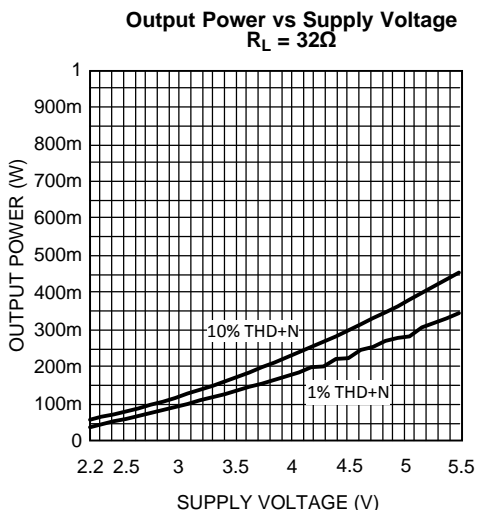

Figure 23.

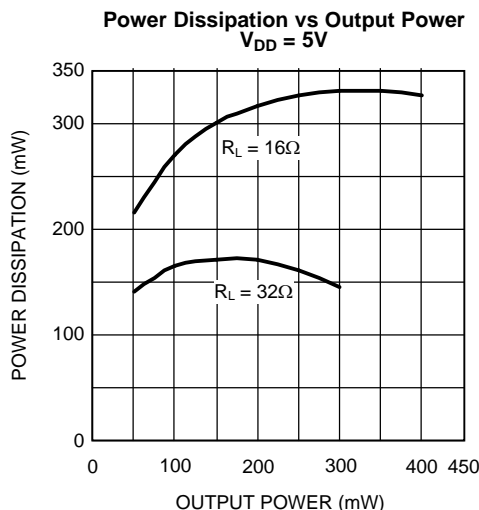

Figure 24.

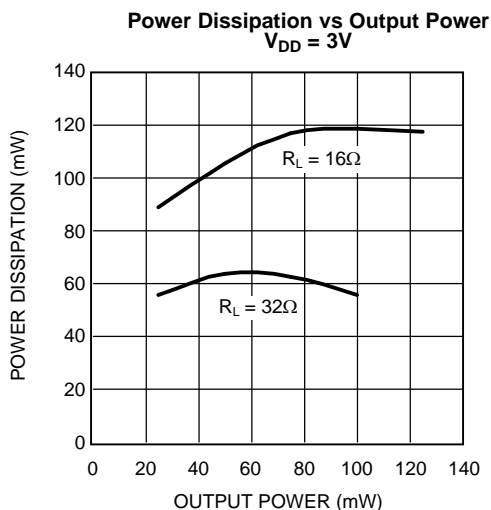

Figure 25.

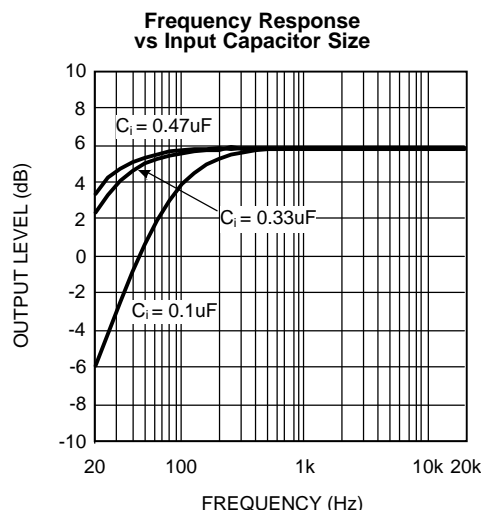

Figure 26.

Typical Performance Characteristics (continued)

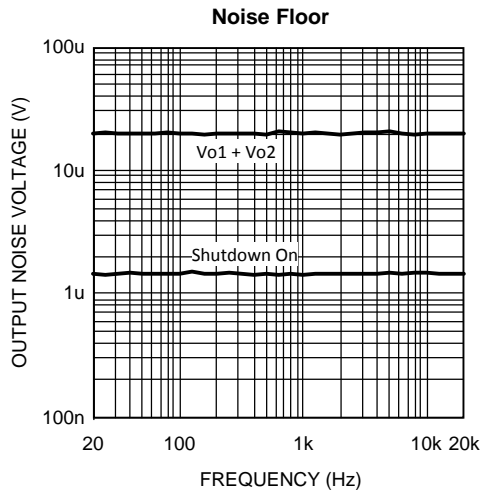

Figure 27.

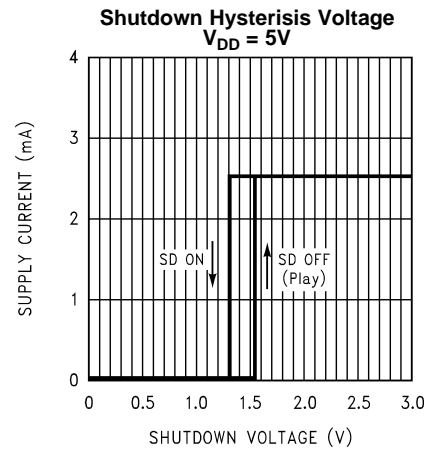

Figure 28.

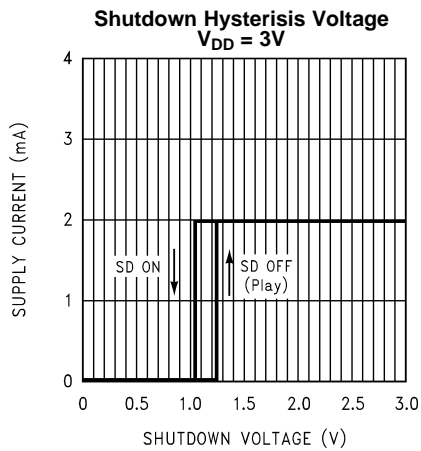

Figure 29.

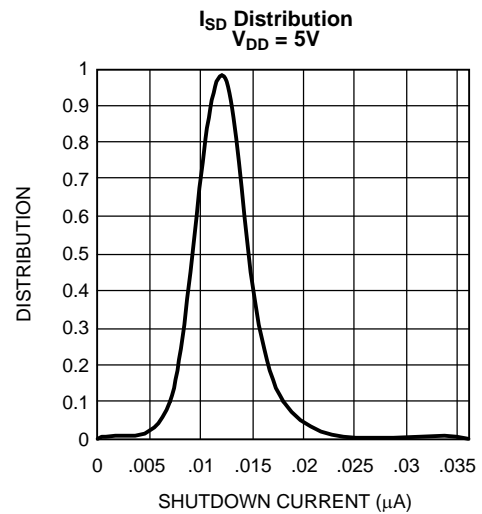

Figure 30.

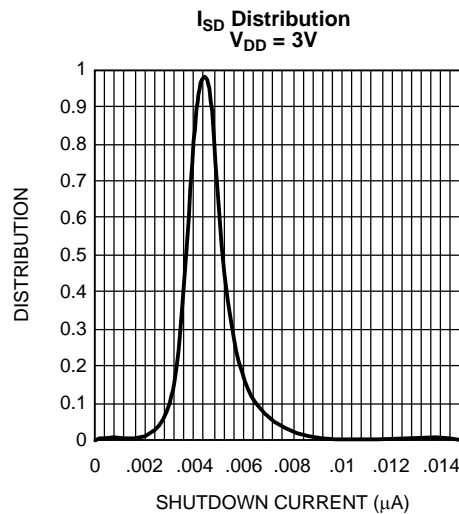

Figure 31.

## APPLICATION INFORMATION

### DIFFERENTIAL AMPLIFIER EXPLANATION

The LM4915 is a pseudo-differential audio amplifier that features a fixed gain of 6dB. Internally this is accomplished by two separate sets of inverting amplifiers, each set to a gain of 2. The LM4915 features precisely matched internal gain-setting resistors set to  $R_i = 20k\Omega$  and  $R_f = 40k\Omega$ , thus eliminating the need for external resistors and fixing the differential gain at  $A_{VD} = 6dB$ .

A differential amplifier works in a manner where the difference between the two input signals is amplified. In most applications, this would require input signals that are  $180^\circ$  out of phase with each other. The LM4915 works in a pseudo-differential manner, so DC offset normally cancelled by a fully differential amplifier needs to be blocked by input coupling capacitors for the LM4915 to amplify the difference between the inputs.

The LM4915 provides what is known as a 'bridged mode' output (bridge-tied-load, BTL). This results in output signals at  $V_{o1}$  and  $V_{o2}$  that are  $180^\circ$  out of phase with respect to each other. Bridged mode operation is different from the single-ended amplifier configuration that connects the load between the amplifier output and ground. A bridged amplifier design has distinct advantages over the single-ended configuration: it provides differential drive to the load, thus doubling maximum possible output swing for a specific supply voltage. Four times the output power is possible compared with a single-ended amplifier under the same conditions.

This increase in attainable output power assumes that the amplifier is not current limited or clipped. A bridged configuration, such as the one used in the LM4915, also creates a second advantage over single-ended amplifiers. Since the differential outputs,  $V_{o1}$  and  $V_{o2}$ , are biased at half-supply, no net DC voltage exists across the load. BTL configuration eliminates the output coupling capacitor required in single-supply, single-ended amplifier configurations. If an output coupling capacitor is not used in a single-ended output configuration, the half-supply bias across the load would result in both increased internal IC power dissipation as well as permanent loudspeaker damage.

### POWER DISSIPATION

Power dissipation is a major concern when designing a successful amplifier, whether the amplifier is bridged or single-ended. Equation 1 states the maximum power dissipation point for a single-ended amplifier operating at a given supply voltage and driving a specified output load.

$$P_{DMAX} = (V_{DD})^2 / (2\pi^2 R_L) \quad \text{Single-Ended} \quad (1)$$

However, a direct consequence of the increased power delivered to the load by a bridge amplifier is an increase in internal power dissipation versus a single-ended amplifier operating at the same conditions.

$$P_{DMAX} = 4(V_{DD})^2 / (2\pi^2 R_L) \quad \text{Bridge Mode} \quad (2)$$

Since the LM4915 has bridged outputs, the maximum internal power dissipation is 4 times that of a single-ended amplifier.

Even with this substantial increase in power dissipation, the LM4915 does not require additional heatsinking under most operating conditions and output loading. From Equation 2, assuming a 5V power supply and an  $16\Omega$  load, the maximum power dissipation point is 316mW. The maximum power dissipation point obtained from Equation 2 must not be greater than the power dissipation results from Equation 3:

$$P_{DMAX} = (T_{JMAX} - T_A) / \theta_{JA} \quad (3)$$

The LM4915's  $\theta_{JA}$  in an NGP0008A package is  $140^\circ C/W$ . Depending on the ambient temperature,  $T_A$ , of the system surroundings, Equation 3 can be used to find the maximum internal power dissipation supported by the IC packaging. If the result of Equation 2 is greater than that of Equation 3, then either the supply voltage must be decreased, the load impedance increased, the ambient temperature reduced, or the  $\theta_{JA}$  reduced with heatsinking. In many cases, larger traces near the output,  $V_{DD}$ , and GND pins can be used to lower the  $\theta_{JA}$ . The larger areas of copper provide a form of heatsinking allowing higher power dissipation. For the typical application of a 5V power supply, with a  $16\Omega$  load power dissipation is not an issue. Recall that internal power dissipation is a function of output power. If typical operation is not around the maximum power dissipation point, the LM4915 can operate at higher ambient temperatures. Refer to the [Typical Performance Characteristics](#) curves for power dissipation information.

## POWER SUPPLY BYPASSING

As with any power amplifier, proper supply bypassing is critical for low noise performance and high power supply rejection ratio (PSRR). The capacitor location on both the bypass and power supply pins should be as close to the device as possible. A larger half-supply bypass capacitor improves PSRR because it increases half-supply stability.

Typical applications employ a 5V regulator with 10 $\mu$ F and 0.1 $\mu$ F bypass capacitors that increase supply stability. This, however, does not eliminate the need for bypassing the supply nodes of the LM4915. A 1 $\mu$ F capacitor is recommended for  $C_S$ . A 4.7 $\mu$ F capacitor is recommended for  $C_B$ . This value coupled with small input capacitors (0.1 $\mu$ F to 0.47 $\mu$ F) gives virtually zero click and pop with outstanding PSRR performance.

## MICRO POWER SHUTDOWN

The voltage applied to the SHUTDOWN pin controls the LM4915's shutdown function. Activate micro-power shutdown by applying a logic-low voltage to the SHUTDOWN pin. When active, the LM4915's micro-power shutdown feature turns off the amplifier's bias circuitry, reducing the supply current. The trigger point is 0.4V for a logic-low level, and 1.8V for a logic-high level. The low 0.1 $\mu$ A (typ) shutdown current is achieved by applying a voltage that is as near as ground as possible to the SHUTDOWN pin. A voltage that is higher than ground may increase the shutdown current. There are a few ways to control the micro-power shutdown. These include using a single-pole, single-throw switch, a microprocessor, or a microcontroller. When using a switch, connect an external 100k. pull-up resistor between the SHUTDOWN pin and  $V_{DD}$ . Connect the switch between the SHUTDOWN pin and ground. Select normal amplifier operation by opening the switch. Closing the switch connects the SHUTDOWN pin to ground, activating micro-power shutdown.

The switch and resistor ensure that the SHUTDOWN pin will not float. This prevents unwanted state changes. In a system with a microprocessor or microcontroller, use a digital output to apply the control voltage to the SHUTDOWN pin. Driving the SHUTDOWN pin with active circuitry eliminates the pull-up resistor.

## PROPER SELECTION OF EXTERNAL COMPONENTS

Proper selection of external components in applications using integrated power amplifiers is critical to optimize device and system performance. While the LM4915 is tolerant of external component combinations, and requires minimal external components, consideration to component values must be used to maximize overall system quality.

The input coupling capacitor,  $C_i$ , forms a first order high pass filter which limits low frequency response given by  $f_c = 1/(2\pi R_i C_i)$ .  $R_i$  is internally set to 20k $\Omega$ . This value should be chosen based on needed frequency response for a few distinct reasons.

### Selection of Input Capacitor Size

Large input capacitors are both expensive and space hungry for portable designs. Clearly, a certain sized capacitor is needed to couple in low frequencies without severe attenuation. But in many cases the speakers used in portable systems, whether internal or external, have little ability to reproduce signals below 100Hz to 150Hz. Thus, using a large input capacitor may not increase actual system performance.

In addition to system cost and size, click and pop performance is affected by the size of the input coupling capacitor,  $C_i$ . A larger input coupling capacitor requires more charge to reach its quiescent DC voltage (nominally  $1/2 V_{DD}$ ). This charge comes from the output via the feedback and is apt to create pops upon device enable. Thus, by minimizing the capacitor size based on necessary low frequency response, turn-on pops can be minimized.

Besides minimizing the input capacitor size, careful consideration should be paid to the bypass capacitor value. Bypass capacitor,  $C_B$ , is the most critical component to minimize turn-on pops since it determines how fast the LM4915 turns on. The slower the LM4915's outputs ramp to their quiescent DC voltage (nominally  $1/2 V_{DD}$ ), the smaller the turn-on pop. Choosing  $C_B$  equal to 4.7 $\mu$ F along with a small value of  $C_i$  (in the range of 0.1 $\mu$ F to 0.47 $\mu$ F), should produce a virtually clickless and popless shutdown function. While the device will function properly, (no oscillations or motorboating), with  $C_B$  equal to 1.0 $\mu$ F, the device will be much more susceptible to turn-on clicks and pops. Thus, a value of  $C_B$  equal to 4.7 $\mu$ F is recommended in all but the most cost sensitive designs.

---

**REVISION HISTORY**

<b>Changes from Original (May 2013) to Revision A</b>	<b>Page</b>
<hr/> <ul style="list-style-type: none"><li>• Changed layout of National Data Sheet to TI format .....</li></ul>	<hr/> <a href="#">12</a>

**PACKAGING INFORMATION**

Orderable Device	Status (1)	Package Type	Package Drawing	Pins	Package Qty	Eco Plan (2)	Lead finish/ Ball material (6)	MSL Peak Temp (3)	Op Temp (°C)	Device Marking (4/5)	Samples
LM4915LQX/NOPB	ACTIVE	WQFN	NGP	8	4500	RoHS & Green	SN	Level-3-260C-168 HR	-40 to 85	GA5	Samples

(1) The marketing status values are defined as follows:

**ACTIVE:** Product device recommended for new designs.

**LIFEBUY:** TI has announced that the device will be discontinued, and a lifetime-buy period is in effect.

**NRND:** Not recommended for new designs. Device is in production to support existing customers, but TI does not recommend using this part in a new design.

**PREVIEW:** Device has been announced but is not in production. Samples may or may not be available.

**OBSOLETE:** TI has discontinued the production of the device.

(2) **RoHS:** TI defines "RoHS" to mean semiconductor products that are compliant with the current EU RoHS requirements for all 10 RoHS substances, including the requirement that RoHS substance do not exceed 0.1% by weight in homogeneous materials. Where designed to be soldered at high temperatures, "RoHS" products are suitable for use in specified lead-free processes. TI may reference these types of products as "Pb-Free".

**RoHS Exempt:** TI defines "RoHS Exempt" to mean products that contain lead but are compliant with EU RoHS pursuant to a specific EU RoHS exemption.

**Green:** TI defines "Green" to mean the content of Chlorine (Cl) and Bromine (Br) based flame retardants meet JS709B low halogen requirements of <=1000ppm threshold. Antimony trioxide based flame retardants must also meet the <=1000ppm threshold requirement.

(3) MSL, Peak Temp. - The Moisture Sensitivity Level rating according to the JEDEC industry standard classifications, and peak solder temperature.

(4) There may be additional marking, which relates to the logo, the lot trace code information, or the environmental category on the device.

(5) Multiple Device Markings will be inside parentheses. Only one Device Marking contained in parentheses and separated by a "-" will appear on a device. If a line is indented then it is a continuation of the previous line and the two combined represent the entire Device Marking for that device.

(6) Lead finish/Ball material - Orderable Devices may have multiple material finish options. Finish options are separated by a vertical ruled line. Lead finish/Ball material values may wrap to two lines if the finish value exceeds the maximum column width.

**Important Information and Disclaimer:** The information provided on this page represents TI's knowledge and belief as of the date that it is provided. TI bases its knowledge and belief on information provided by third parties, and makes no representation or warranty as to the accuracy of such information. Efforts are underway to better integrate information from third parties. TI has taken and continues to take reasonable steps to provide representative and accurate information but may not have conducted destructive testing or chemical analysis on incoming materials and chemicals. TI and TI suppliers consider certain information to be proprietary, and thus CAS numbers and other limited information may not be available for release.

In no event shall TI's liability arising out of such information exceed the total purchase price of the TI part(s) at issue in this document sold by TI to Customer on an annual basis.

**TAPE AND REEL INFORMATION**

**QUADRANT ASSIGNMENTS FOR PIN 1 ORIENTATION IN TAPE**

\*All dimensions are nominal

Device	Package Type	Package Drawing	Pins	SPQ	Reel Diameter (mm)	Reel Width W1 (mm)	A0 (mm)	B0 (mm)	K0 (mm)	P1 (mm)	W (mm)	Pin1 Quadrant
LM4915LQX/NOPB	WQFN	NGP	8	4500	330.0	12.4	2.2	2.2	1.0	8.0	12.0	Q1

**TAPE AND REEL BOX DIMENSIONS**

\*All dimensions are nominal

Device	Package Type	Package Drawing	Pins	SPQ	Length (mm)	Width (mm)	Height (mm)
LM4915LQX/NOPB	WQFN	NGP	8	4500	356.0	356.0	35.0



NGP0008A

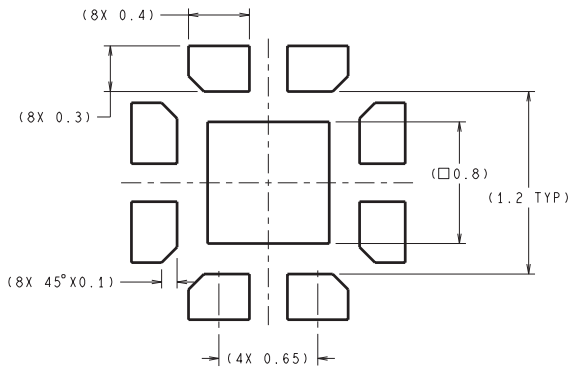

DIMENSIONS ARE IN MILLIMETERS

**RECOMMENDED LAND PATTERN**  
1:1 RATIO WITH PKG SOLDER PADS

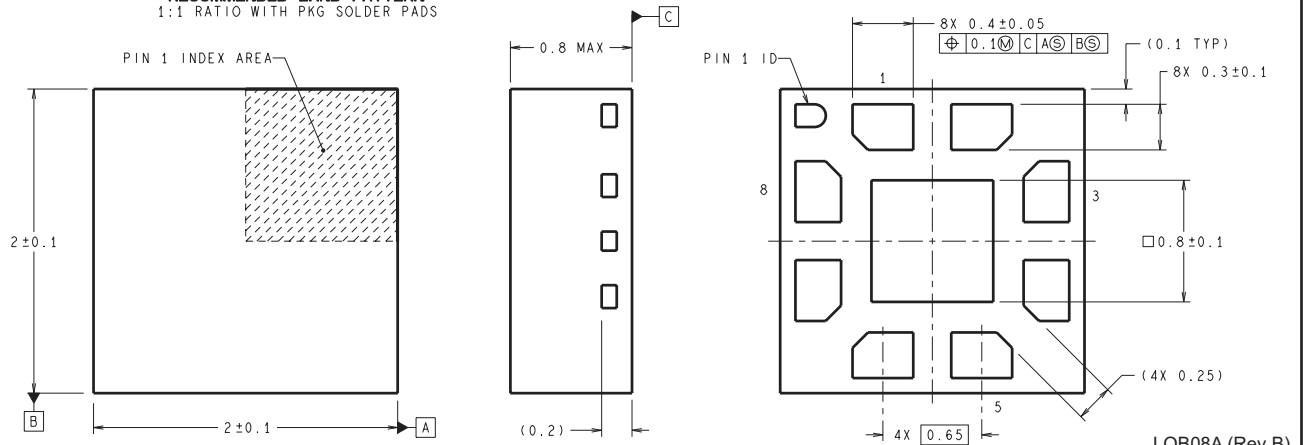

LQB08A (Rev B)

## IMPORTANT NOTICE AND DISCLAIMER

TI PROVIDES TECHNICAL AND RELIABILITY DATA (INCLUDING DATA SHEETS), DESIGN RESOURCES (INCLUDING REFERENCE DESIGNS), APPLICATION OR OTHER DESIGN ADVICE, WEB TOOLS, SAFETY INFORMATION, AND OTHER RESOURCES "AS IS" AND WITH ALL FAULTS, AND DISCLAIMS ALL WARRANTIES, EXPRESS AND IMPLIED, INCLUDING WITHOUT LIMITATION ANY IMPLIED WARRANTIES OF MERCHANTABILITY, FITNESS FOR A PARTICULAR PURPOSE OR NON-INFRINGEMENT OF THIRD PARTY INTELLECTUAL PROPERTY RIGHTS.

These resources are intended for skilled developers designing with TI products. You are solely responsible for (1) selecting the appropriate TI products for your application, (2) designing, validating and testing your application, and (3) ensuring your application meets applicable standards, and any other safety, security, regulatory or other requirements.

These resources are subject to change without notice. TI grants you permission to use these resources only for development of an application that uses the TI products described in the resource. Other reproduction and display of these resources is prohibited. No license is granted to any other TI intellectual property right or to any third party intellectual property right. TI disclaims responsibility for, and you will fully indemnify TI and its representatives against, any claims, damages, costs, losses, and liabilities arising out of your use of these resources.

TI's products are provided subject to [TI's Terms of Sale](#) or other applicable terms available either on [ti.com](#) or provided in conjunction with such TI products. TI's provision of these resources does not expand or otherwise alter TI's applicable warranties or warranty disclaimers for TI products.

TI objects to and rejects any additional or different terms you may have proposed.

Mailing Address: Texas Instruments, Post Office Box 655303, Dallas, Texas 75265  
Copyright © 2022, Texas Instruments Incorporated

## X-ON Electronics

Largest Supplier of Electrical and Electronic Components

*Click to view similar products for [Audio Amplifiers](#) category:*

*Click to view products by [Texas Instruments](#) manufacturer:*

Other Similar products are found below :

[LV47002P-E](#) [NCP2890AFCT2G](#) [NTE1192](#) [LC706200CM](#) [IS31AP4915A-QFLS2-TR](#) [TDA1591T](#) [TS2012EIJT](#) [NCP2809BMUTXG](#)  
[NJW1157BFC2](#) [IS31AP4996-GRLS2-TR](#) [NCP2823BFCT1G](#) [BD88420GUL-E2](#) [LA4450L-E](#) [IS31AP2036A-CLS2-TR](#) [NTE1110](#) [NTE7100](#)  
[NTE7114](#) [NTE7163](#) [NTE7168](#) [NTE7177](#) [NTE7178](#) [NTE7186](#) [NTE7198](#) [NTE7202](#) [NTE7217](#) [BD88400GUL-E2](#) [BD88200GUL-E2](#)  
[SABRE9601K](#) [THAT1646W16-U](#) [PAM8965ZLA40-13](#) [TSDP10XX1NLGXZBX](#) [TSDP11XX1NKGIZBX](#) [TSDP11XX1NLGXZBX](#)  
[TSDP10XX1NKGIZBX](#) [NJM4580CV-TE1](#) [NJU7084R-TE1](#) [OPA1655DR](#) [LV4910T-MPB-E](#) [NCP2890AFCT2](#) [NCV2211DR2G](#)  
[SCY99091FCT2G](#) [TAS5720MRSMR](#) [AW87389FCR](#) [AW8737AFCR](#) [TDA2005R](#) [TDA2030](#) [TDA7265L-J11-A-T](#) [CD2050CZ](#)  
[AW88261FCR](#) [TDA7377-JSM](#)