

# LMV321A-Q1、LMV358A-Q1、LMV324A-Q1 汽车类、低电压、轨至轨输出运算放大器

## 1 特性

- 符合面向汽车应用的 AEC-Q100 标准
  - 温度等级 1：-40°C 至 +125°C，TA
  - 器件 HBM ESD 分类等级 2
  - 器件 CDM ESD 分类等级 C6
- 低输入失调电压：±1mV
- 轨至轨输出
- 单位带宽增益积：1MHz
- 低宽带噪声：30nV/√Hz
- 低输入偏置电流：10pA
- 低静态电流：70μA/通道
- 单位增益稳定
- 内置 RFI 和 EMI 滤波器
- 可在电源电压低至 2.5V 的情况下运行
- 由于具有电阻式开环输出阻抗，因此可在更高的容性负载下更轻松地实现稳定
- 工作温度范围：-40°C 至 125°C

## 2 应用

- 针对 AEC-Q100 1 级应用进行了优化
- 信息娱乐系统与仪表组
- 被动安全
- 车身电子装置和照明
- 混合动力汽车/电动汽车逆变器和电机控制
- 车载充电器 (OBC) 和无线充电器
- 动力总成电流传感器
- 高级驾驶辅助系统 (ADAS)
- 单电源、低侧、单向电流感应电路

## 3 说明

LMV3xxA-Q1 系列包括单通道 (LMV321A-Q1)、双通道 (LMV358A-Q1) 和四通道 (LMV324A-Q1) 低压 (2.5V 至 5.5V) 汽车类运算放大器，具有轨至轨输出摆幅功能。这些运算放大器为空间受限、需要低压运行和高容性负载驱动的应用 (例如信息娱乐系统和照明) 提供了一种具有成本效益的方法。LMV3xxA-Q1 系列的容性负载驱动具有 500pF 的电容，而电阻式开环输出阻抗使其易于在更高的容性负载下保持稳定。这些运算放大器专为低工作电压 (2.5V 至 5.5V) 而设计，性能规格类似于 LMV3xx-Q1 器件。

LMV3xxA-Q1 系列的稳健设计可简化电路设计。这些运算放大器具有单位增益稳定性，集成了 RFI 和 EMI 抑制滤波器，并且在过驱情况下不会出现相位反转。

LMV3xxA-Q1 可采用 SOIC、MSOP、SOT-23 和 TSSOP 等业界通用的封装。

### 器件信息<sup>(1)</sup>

器件型号	封装	封装尺寸 (标称值)
LMV321A-Q1	SOT-23 (5) <sup>(2)</sup>	1.60mm × 2.90mm
	SC70 (5)	1.25mm × 2.00mm
LMV358A-Q1	SOIC (8)	3.91mm × 4.90mm
	VSSOP (8)	3.00mm × 3.00mm
LMV324A-Q1	SOIC (14)	8.65mm × 3.91mm
	TSSOP (14)	4.40mm × 5.00mm
	SOT-23 (14)	4.20mm × 1.90mm

(1) 如需了解所有可用封装，请参阅数据表末尾的可订购产品附录。

(2) 仅表示封装为预发布。

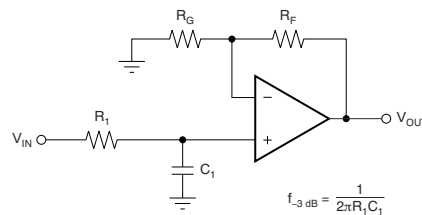

$$\frac{V_{OUT}}{V_{IN}} = \left(1 + \frac{R_F}{R_G}\right) \left(\frac{1}{1 + sR_1C_1}\right)$$

单极低通滤波器



## Table of Contents

<b>1 特性</b> .....	1	<b>8 Application and Implementation</b> .....	16
<b>2 应用</b> .....	1	8.1 Application Information.....	16
<b>3 说明</b> .....	1	8.2 Typical Application.....	16
<b>4 Revision History</b> .....	2	<b>9 Power Supply Recommendations</b> .....	22
<b>5 Pin Configuration and Functions</b> .....	3	9.1 Input and ESD Protection.....	22
<b>6 Specifications</b> .....	5	<b>10 Layout</b> .....	23
6.1 Absolute Maximum Ratings.....	5	10.1 Layout Guidelines.....	23
6.2 ESD Ratings.....	5	10.2 Layout Example.....	23
6.3 Recommended Operating Conditions.....	5	<b>11 Device and Documentation Support</b> .....	24
6.4 Thermal Information: LMV321A-Q1.....	6	11.1 Documentation Support.....	24
6.5 Thermal Information: LMV358A-Q1.....	6	11.2 Related Links.....	24
6.6 Thermal Information: LMV324A-Q1.....	6	11.3 Receiving Notification of Documentation Updates..	24
6.7 Electrical Characteristics.....	7	11.4 支持资源.....	24
6.8 Typical Characteristics.....	8	11.5 Trademarks.....	24
<b>7 Detailed Description</b> .....	14	11.6 静电放电警告.....	24
7.1 Overview.....	14	11.7 术语表.....	24
7.2 Functional Block Diagram.....	14	<b>12 Mechanical, Packaging, and Orderable Information</b> .....	24
7.3 Feature Description.....	15		
7.4 Device Functional Modes.....	15		

## 4 Revision History

注：以前版本的页码可能与当前版本的页码不同

<b>Changes from Revision B (October 2021) to Revision C (January 2023)</b>	<b>Page</b>
• 删除了 <i>器件信息</i> 表中 SC70 (5) 封装的预发布说明.....	1
• Changed the formatting of the <i>Pin Configuration and Functions</i> section.....	3
• Changed values in <i>Thermal Information: LMV321A-Q1</i> table.....	6
<b>Changes from Revision A (April 2021) to Revision B (October 2021)</b>	<b>Page</b>
• 在数据表添加了 LMV321A-Q1 GPN.....	1
• 在 <i>器件信息</i> 表中添加了 SOT-23 (5) 和 SC70 (5) 封装.....	1
• 删除了 <i>器件信息</i> 表中 SOT-23 (14) 和 TSSOP (14) 封装的预发布说明.....	1
• Added LMV321A-Q1 SOT-23 (5), SC70 (5), and LMV321AU-Q1 SOT-23 (5) packages to <i>Pin Configuration and Functions</i> section.....	3
• Added <i>Thermal Information: LMV321A-Q1</i> table.....	6
<b>Changes from Revision * (June 2020) to Revision A (April 2021)</b>	<b>Page</b>
• 更新了整个文档中的表格、图和交叉参考的编号格式.....	1
• 删除了 <i>器件信息</i> 表中 VSSOP (8) 封装的预览说明.....	1
• 删除了 <i>器件信息</i> 表中的 SOT-23 (8)、TSSOP (8)、SOT-23 (5) 和 SC70 (5) 封装.....	1
• Deleted TSSOP (8) package from <i>Pin Configuration and Functions</i> section.....	3
• Added note (4) to differential input voltage in <i>Absolute Maximum Ratings</i> table.....	5
• Added thermal information for DGK package.....	6
• Added thermal information for DYY package.....	6

## 5 Pin Configuration and Functions



图 5-1. LMV321A-Q1 DBV Package  
5-Pin SOT-23  
Top View



图 5-2. LMV321A-Q1 DCK, LMV321AU-Q1 DBV  
Package  
5-Pin SC70, SOT-23  
Top View

表 5-1. Pin Functions: LMV321A-Q1

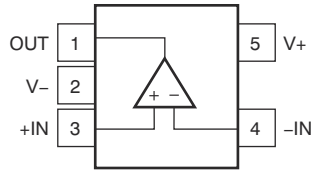
NAME	PIN		I/O	DESCRIPTION
	DBV	DCK, DBV (U)		
- IN	4	3	I	Inverting input
+IN	3	1	I	Noninverting input
OUT	1	4	O	Output
V -	2	2	—	Negative (lowest) supply or ground (for single-supply operation)
V+	5	5	—	Positive (highest) supply

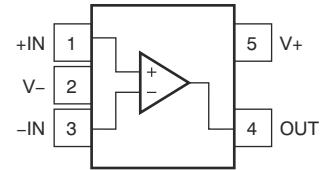

图 5-3. LMV358A-Q1 D and DGK Packages  
8-Pin SOIC and VSSOP  
Top View

表 5-2. Pin Functions: LMV358A-Q1

NAME	PIN		I/O	DESCRIPTION
	NO.			
- IN A	2		I	Inverting input, channel A
+IN A	3		I	Noninverting input, channel A
- IN B	6		I	Inverting input, channel B
+IN B	5		I	Noninverting input, channel B
OUT A	1		O	Output, channel A
OUT B	7		O	Output, channel B
V -	4		—	Negative (lowest) supply or ground (for single-supply operation)
V+	8		—	Positive (highest) supply

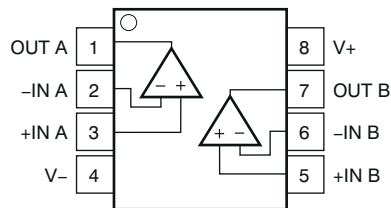
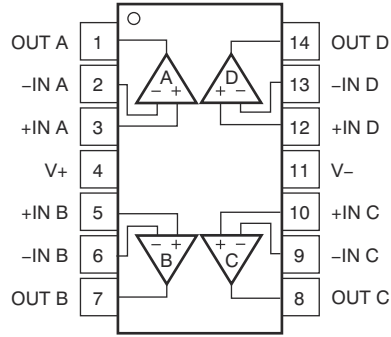

**图 5-4. LMV324A-Q1 D, PW, and DYY Packages  
 14-Pin SOIC, TSSOP, and SOT-23  
 Top View**

**表 5-3. Pin Functions: LMV324A-Q1**

PIN		I/O	DESCRIPTION
NAME	NO.		
- IN A	2	I	Inverting input, channel A
+IN A	3	I	Noninverting input, channel A
- IN B	6	I	Inverting input, channel B
+IN B	5	I	Noninverting input, channel B
- IN C	9	I	Inverting input, channel C
+IN C	10	I	Noninverting input, channel C
- IN D	13	I	Inverting input, channel D
+IN D	12	I	Noninverting input, channel D
OUT A	1	O	Output, channel A
OUT B	7	O	Output, channel B
OUT C	8	O	Output, channel C
OUT D	14	O	Output, channel D
V -	11	—	Negative (lowest) supply or ground (for single-supply operation)
V+	4	—	Positive (highest) supply

## 6 Specifications

### 6.1 Absolute Maximum Ratings

over operating temperature range (unless otherwise noted)<sup>(1)</sup>

		MIN	MAX	UNIT	
Supply voltage, ([V+] - [V-])		0	6	V	
Signal input pins	Voltage <sup>(2)</sup>	Common-mode	(V-) - 0.5	(V+) + 0.5	V
		Differential <sup>(4)</sup>	(V+) - (V-) + 0.2		V
	Current <sup>(2)</sup>	- 10	10	mA	
Output short-circuit <sup>(3)</sup>		Continuous			
Operating, T <sub>A</sub>		- 55	150	°C	
Operating junction temperature, T <sub>J</sub>			150	°C	
Storage temperature, T <sub>stg</sub>		- 65	150	°C	

- (1) Stresses beyond those listed under *Absolute Maximum Ratings* may cause permanent damage to the device. These are stress ratings only, and functional operation of the device at these or any other conditions beyond those indicated under *Recommended Operating Conditions* is not implied. Exposure to absolute-maximum-rated conditions for extended periods may affect device reliability.
- (2) Input pins are diode-clamped to the power-supply rails. Input signals that may swing more than 0.5 V beyond the supply rails must be current limited to 10 mA or less.
- (3) Short-circuit to ground, one amplifier per package.
- (4) Differential input voltages greater than 0.5 V applied continuously can result in a shift to the input offset voltage and quiescent current above the maximum specifications of these parameters. The magnitude of this effect increases as the ambient operating temperature rises.

### 6.2 ESD Ratings

			VALUE	UNIT
V <sub>(ESD)</sub>	Electrostatic discharge	Human-body model (HBM), per AEC Q100-002 HBM ESD Classification Level 2 <sup>(1)</sup>	±2000	V
		Charged-device model (CDM), per AEC Q100-011 CDM ESD Classification Level C5	±1000	

- (1) AEC Q100-002 indicates that HBM stressing shall be in accordance with ANSI/ESDA/JEDEC JS-001 Specification

### 6.3 Recommended Operating Conditions

over operating temperature range (unless otherwise noted)

		MIN	MAX	UNIT
V <sub>S</sub>	Supply voltage	2.5	5.5	V
T <sub>A</sub>	Specified temperature	- 40	125	°C

## 6.4 Thermal Information: LMV321A-Q1

THERMAL METRIC <sup>(1)</sup>		LMV321A-Q1		UNIT
		DBV (SOT-23)	DCK (SC70)	
		5 PINS	5 PINS	
$R_{\theta JA}$	Junction-to-ambient thermal resistance	232.5	246.6	°C/W
$R_{\theta JC(top)}$	Junction-to-case (top) thermal resistance	131.0	157.5	°C/W
$R_{\theta JB}$	Junction-to-board thermal resistance	99.6	95.4	°C/W
$\psi_{JT}$	Junction-to-top characterization parameter	66.5	68.8	°C/W
$\psi_{JB}$	Junction-to-board characterization parameter	99.1	95.0	°C/W

(1) For more information about traditional and new thermal metrics, see [Semiconductor and IC Package Thermal Metrics](#).

## 6.5 Thermal Information: LMV358A-Q1

THERMAL METRIC <sup>(1)</sup>		LMV358A-Q1		UNIT
		D (SOIC)	DGK (VSSOP)	
		8 PINS	8 PINS	
$R_{\theta JA}$	Junction-to-ambient thermal resistance	151.9	196.6	°C/W
$R_{\theta JC(top)}$	Junction-to-case (top) thermal resistance	92.0	86.2	°C/W
$R_{\theta JB}$	Junction-to-board thermal resistance	95.4	118.3	°C/W
$\psi_{JT}$	Junction-to-top characterization parameter	40.2	23.2	°C/W
$\psi_{JB}$	Junction-to-board characterization parameter	94.7	116.7	°C/W

(1) For more information about traditional and new thermal metrics, see [Semiconductor and IC Package Thermal Metrics](#).

## 6.6 Thermal Information: LMV324A-Q1

THERMAL METRIC <sup>(1)</sup>		LMV324A-Q1			UNIT
		D (SOIC)	PW (TSSOP)	DYY (SOT-23)	
		14 PINS	14 PINS	14 PINS	
$R_{\theta JA}$	Junction-to-ambient thermal resistance	115.1	135.3	154.3	°C/W
$R_{\theta JC(top)}$	Junction-to-case (top) thermal resistance	71.2	63.5	86.8	°C/W
$R_{\theta JB}$	Junction-to-board thermal resistance	71.1	78.4	67.9	°C/W
$\psi_{JT}$	Junction-to-top characterization parameter	29.6	13.6	10.1	°C/W
$\psi_{JB}$	Junction-to-board characterization parameter	70.7	77.9	67.5	°C/W

## 6.7 Electrical Characteristics

For  $V_S = (V^+) - (V^-) = 2.5\text{ V to }5.5\text{ V}$  ( $\pm 0.9\text{ V to } \pm 2.75\text{ V}$ ),  $T_A = 25^\circ\text{C}$ ,  $R_L = 10\text{ k}\Omega$  connected to  $V_S / 2$ , and  $V_{CM} = V_{OUT} = V_S / 2$  (unless otherwise noted)

PARAMETER		TEST CONDITIONS	MIN	TYP	MAX	UNIT
<b>OFFSET VOLTAGE</b>						
$V_{OS}$	Input offset voltage	$V_S = 5\text{ V}$		$\pm 1$	$\pm 4$	mV
		$V_S = 5\text{ V}$ , $T_A = -40^\circ\text{C to }125^\circ\text{C}$			$\pm 5$	
$dV_{OS}/dT$	$V_{OS}$ vs temperature	$T_A = -40^\circ\text{C to }125^\circ\text{C}$		$\pm 1$		$\mu\text{V}/^\circ\text{C}$
PSRR	Power-supply rejection ratio	$V_S = 2.5\text{ to }5.5\text{ V}$ , $V_{CM} = (V^-)$	78	100		dB
<b>INPUT VOLTAGE RANGE</b>						
$V_{CM}$	Common-mode voltage range	No phase reversal, rail-to-rail input	$(V^-) - 0.1$		$(V^+) - 1$	V
CMRR	Common-mode rejection ratio	$V_S = 2.5\text{ V}$ , $(V^-) - 0.1\text{ V} < V_{CM} < (V^+) - 1.4\text{ V}$ $T_A = -40^\circ\text{C to }125^\circ\text{C}$		86		dB
		$V_S = 5.5\text{ V}$ , $(V^-) - 0.1\text{ V} < V_{CM} < (V^+) - 1.4\text{ V}$ $T_A = -40^\circ\text{C to }125^\circ\text{C}$		95		
		$V_S = 5.5\text{ V}$ , $(V^-) - 0.1\text{ V} < V_{CM} < (V^+) + 0.1\text{ V}$ $T_A = -40^\circ\text{C to }125^\circ\text{C}$	63	77		
		$V_S = 2.5\text{ V}$ , $(V^-) - 0.1\text{ V} < V_{CM} < (V^+) + 0.1\text{ V}$ $T_A = -40^\circ\text{C to }125^\circ\text{C}$		68		
<b>INPUT BIAS CURRENT</b>						
$I_B$	Input bias current	$V_S = 5\text{ V}$		$\pm 10$		pA
$I_{OS}$	Input offset current			$\pm 3$		pA
<b>NOISE</b>						
$E_n$	Input voltage noise (peak-to-peak)	$f = 0.1\text{ Hz to }10\text{ Hz}$ , $V_S = 5\text{ V}$		5.1		$\mu\text{V}_{PP}$
$e_n$	Input voltage noise density	$f = 1\text{ kHz}$ , $V_S = 5\text{ V}$		33		$\text{nV}/\sqrt{\text{Hz}}$
		$f = 10\text{ kHz}$ , $V_S = 5\text{ V}$		30		
$i_n$	Input current noise density	$f = 1\text{ kHz}$ , $V_S = 5\text{ V}$		25		$\text{fA}/\sqrt{\text{Hz}}$
<b>INPUT CAPACITANCE</b>						
$C_{ID}$	Differential			1.5		pF
$C_{IC}$	Common-mode			5		pF
<b>OPEN-LOOP GAIN</b>						
$A_{OL}$	Open-loop voltage gain	$V_S = 5.5\text{ V}$ , $(V^-) + 0.05\text{ V} < V_O < (V^+) - 0.05\text{ V}$ , $R_L = 10\text{ k}\Omega$	100	115		dB
		$V_S = 2.5\text{ V}$ , $(V^-) + 0.04\text{ V} < V_O < (V^+) - 0.04\text{ V}$ , $R_L = 10\text{ k}\Omega$		98		
		$V_S = 2.5\text{ V}$ , $(V^-) + 0.1\text{ V} < V_O < (V^+) - 0.1\text{ V}$ , $R_L = 2\text{ k}\Omega$		112		
		$V_S = 5.5\text{ V}$ , $(V^-) + 0.15\text{ V} < V_O < (V^+) - 0.15\text{ V}$ , $R_L = 2\text{ k}\Omega$		128		
<b>FREQUENCY RESPONSE</b>						
GBW	Gain-bandwidth product	$V_S = 5\text{ V}$		1		MHz
$\phi_m$	Phase margin	$V_S = 5.5\text{ V}$ , $G = 1$		76		$^\circ$
SR	Slew rate	$V_S = 5\text{ V}$		1.7		V/ $\mu\text{s}$
$t_s$	Settling time	To 0.1%, $V_S = 5\text{ V}$ , 2-V step, $G = +1$ , $C_L = 100\text{ pF}$		3		$\mu\text{s}$
		To 0.01%, $V_S = 5\text{ V}$ , 2-V step, $G = +1$ , $C_L = 100\text{ pF}$		4		
$t_{OR}$	Overload recovery time	$V_S = 5\text{ V}$ , $V_{IN} \times \text{gain} > V_S$		0.9		$\mu\text{s}$
THD+N	Total harmonic distortion + noise	$V_S = 5.5\text{ V}$ , $V_{CM} = 2.5\text{ V}$ , $V_O = 1\text{ V}_{RMS}$ , $G = +1$ , $f = 1\text{ kHz}$ , 80-kHz measurement BW		0.005%		
<b>OUTPUT</b>						
$V_O$	Voltage output swing from supply rails	$V_S = 5.5\text{ V}$ , $R_L = 10\text{ k}\Omega$		20	50	mV
		$V_S = 5.5\text{ V}$ , $R_L = 2\text{ k}\Omega$		40	75	
$I_{SC}$	Short-circuit current	$V_S = 5.5\text{ V}$		$\pm 40$		mA
$Z_O$	Open-loop output impedance	$V_S = 5\text{ V}$ , $f = 1\text{ MHz}$		1200		$\Omega$
<b>POWER SUPPLY</b>						
$V_S$	Specified voltage range		2.5 ( $\pm 1.25$ )		5.5 ( $\pm 2.75$ )	V
$I_Q$	Quiescent current per amplifier	$I_O = 0\text{ mA}$ , $V_S = 5.5\text{ V}$		70	125	$\mu\text{A}$
		$I_O = 0\text{ mA}$ , $V_S = 5.5\text{ V}$ , $T_A = -40^\circ\text{C to }125^\circ\text{C}$			150	
	Power-on time	$V_S = 0\text{ V to }5\text{ V}$ , to 90% $I_Q$ level		50		$\mu\text{s}$

## 6.8 Typical Characteristics

at  $T_A = 25^\circ\text{C}$ ,  $V_+ = 2.75\text{ V}$ ,  $V_- = -2.75\text{ V}$ ,  $R_L = 10\text{ k}\Omega$  connected to  $V_S / 2$ ,  $V_{CM} = V_S / 2$ , and  $V_{OUT} = V_S / 2$  (unless otherwise noted)



图 6-1.  $I_B$  and  $I_{OS}$  vs Temperature



图 6-2.  $I_B$  and  $I_{OS}$  vs Common-Mode Voltage

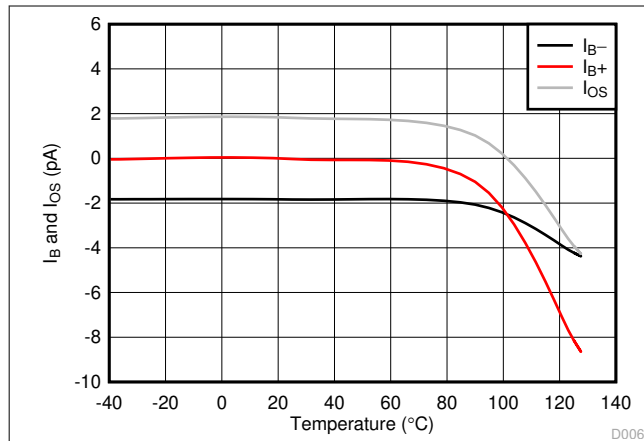

图 6-3. Open-Loop Gain vs Temperature

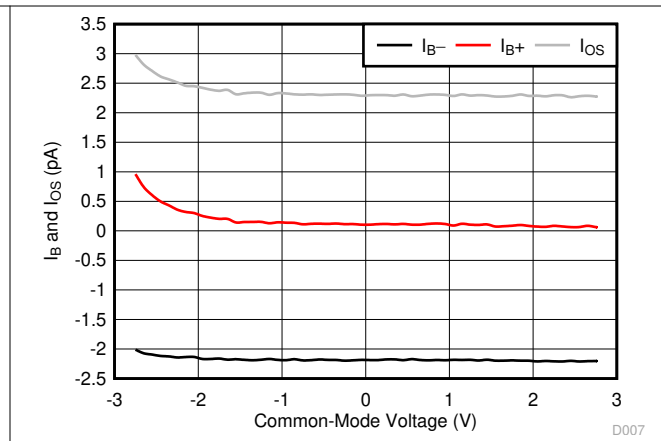

图 6-4. Open-Loop Gain and Phase vs Frequency

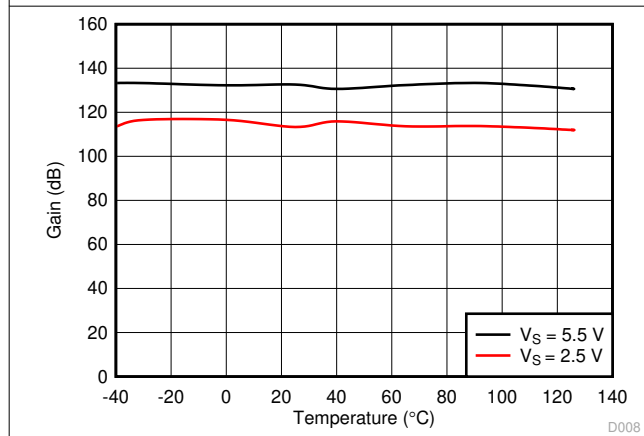

图 6-5. Open-Loop Gain vs Output Voltage

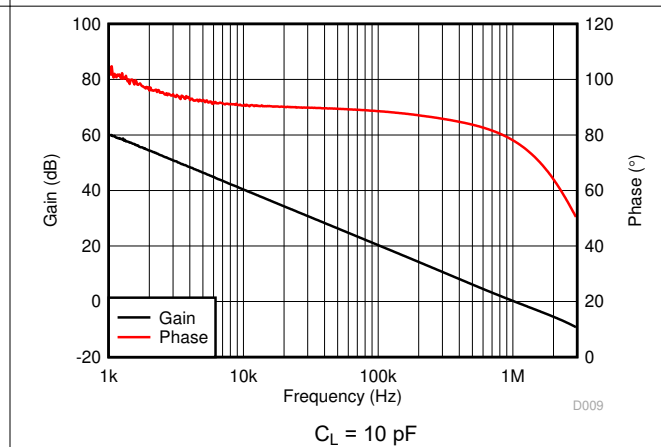

图 6-6. Closed-Loop Gain vs Frequency

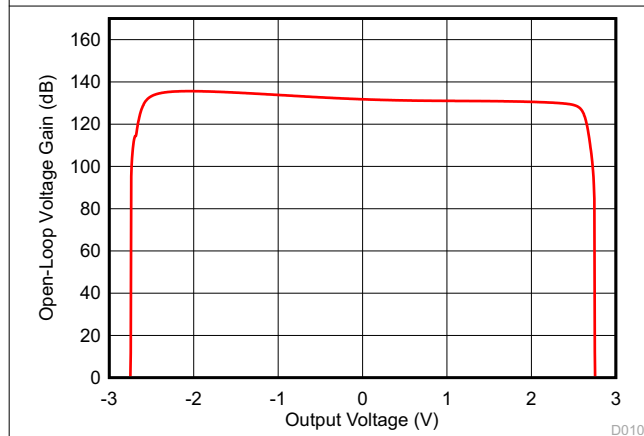

### 6.8 Typical Characteristics (continued)

at  $T_A = 25^\circ\text{C}$ ,  $V_+ = 2.75\text{ V}$ ,  $V_- = -2.75\text{ V}$ ,  $R_L = 10\text{ k}\Omega$  connected to  $V_S / 2$ ,  $V_{CM} = V_S / 2$ , and  $V_{OUT} = V_S / 2$  (unless otherwise noted)

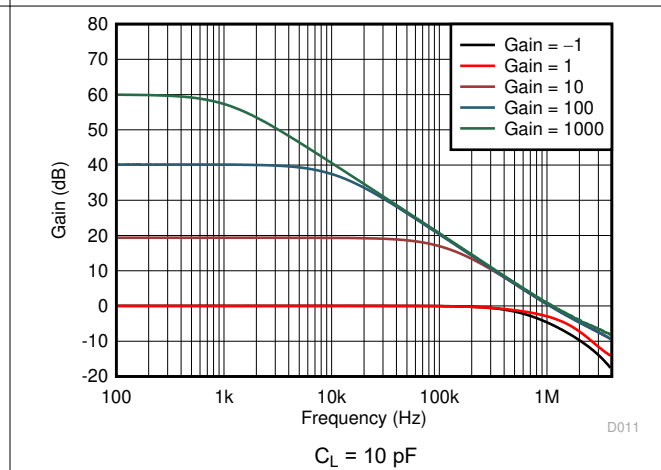

图 6-7. Output Voltage vs Output Current (Claw)



图 6-8. PSRR vs Frequency

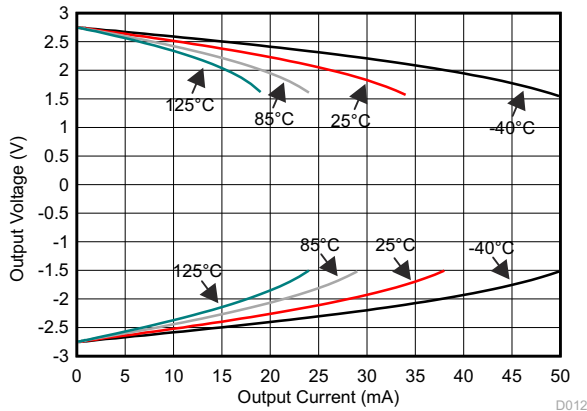

图 6-9. DC PSRR vs Temperature

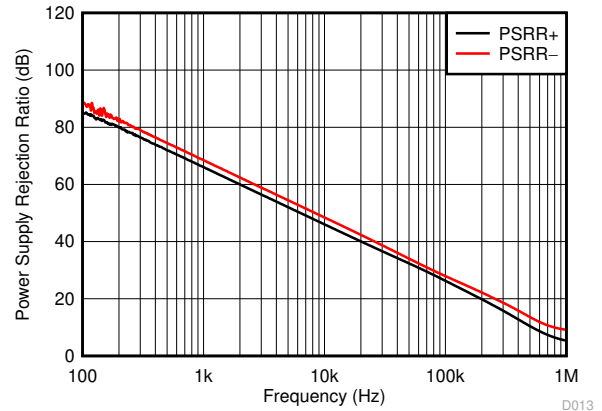

图 6-10. CMRR vs Frequency

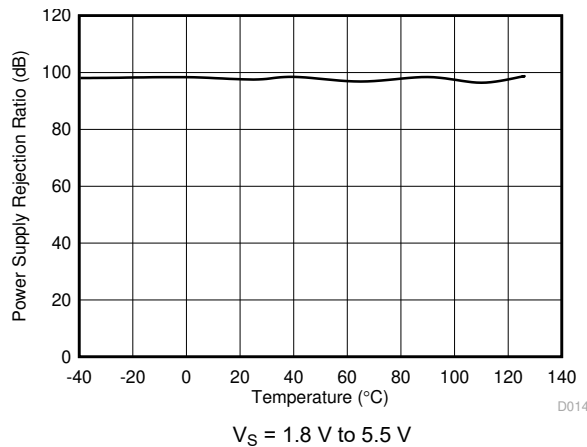

图 6-11. DC CMRR vs Temperature

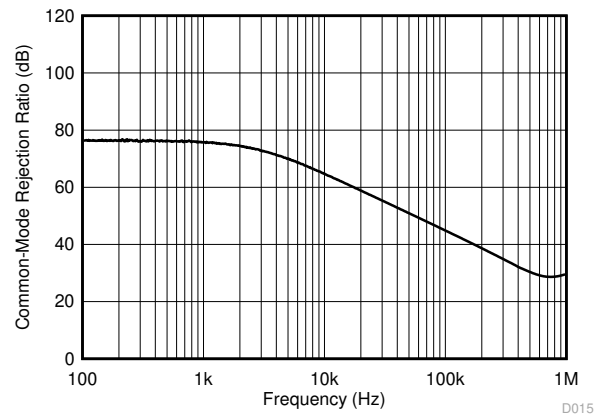

图 6-12. 0.1 Hz to 10 Hz Integrated Voltage Noise

## 6.8 Typical Characteristics (continued)

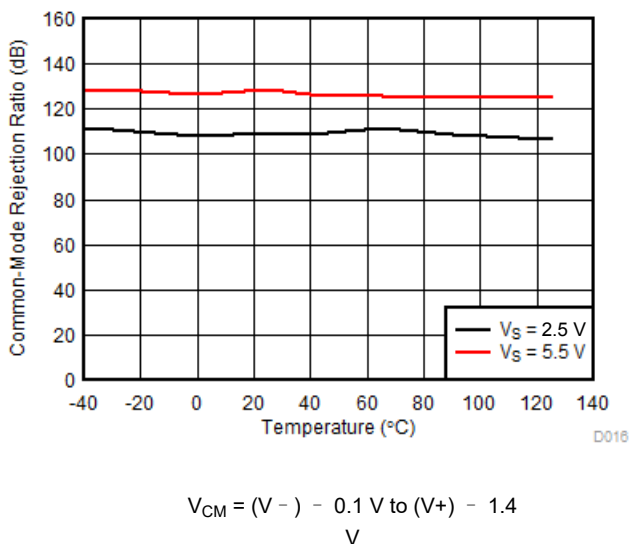
at  $T_A = 25^\circ\text{C}$ ,  $V_+ = 2.75\text{ V}$ ,  $V_- = -2.75\text{ V}$ ,  $R_L = 10\text{ k}\Omega$  connected to  $V_S / 2$ ,  $V_{CM} = V_S / 2$ , and  $V_{OUT} = V_S / 2$  (unless otherwise noted)

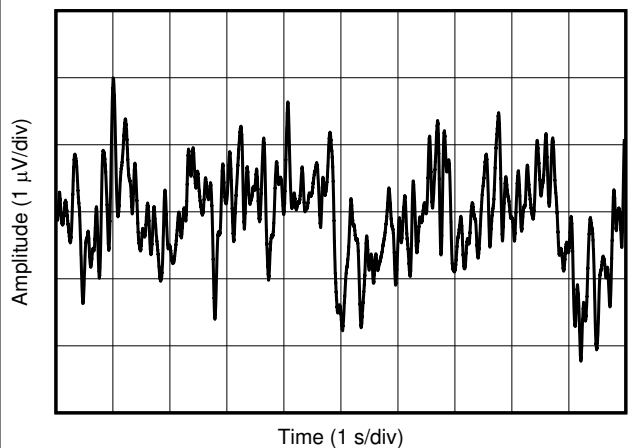

图 6-13. Input Voltage Noise Spectral Density



图 6-14. THD + N vs Frequency

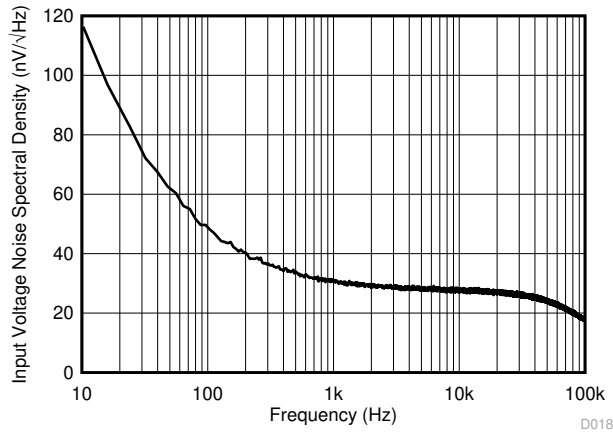

图 6-15. THD + N vs Amplitude

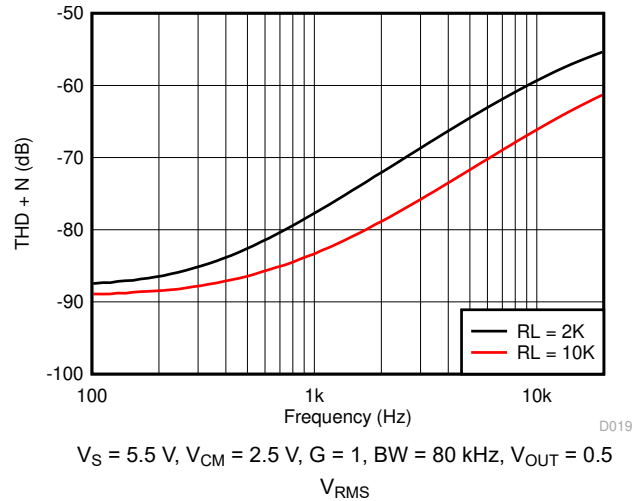

图 6-16. Quiescent Current vs Supply Voltage

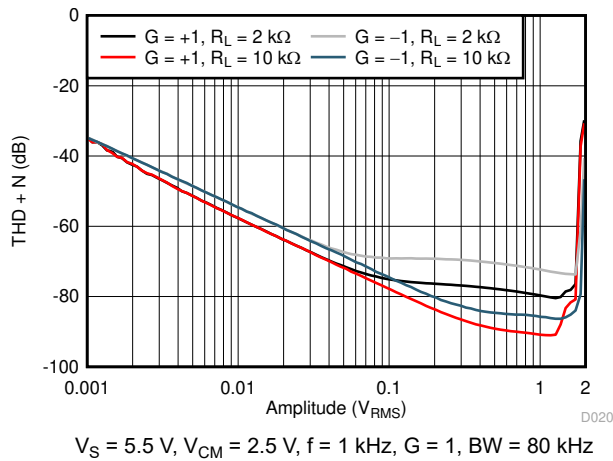

图 6-17. Quiescent Current vs Temperature

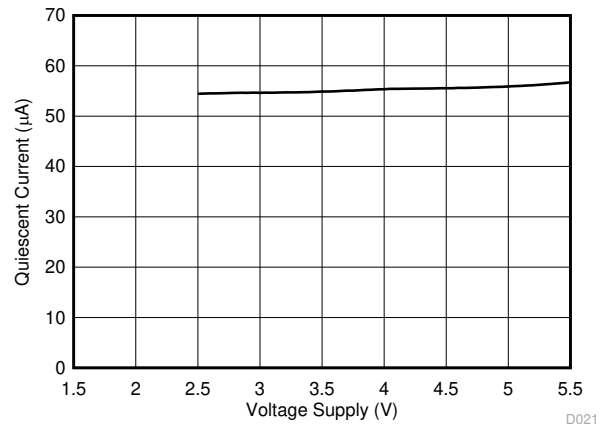

图 6-18. Open-Loop Output Impedance vs Frequency

### 6.8 Typical Characteristics (continued)

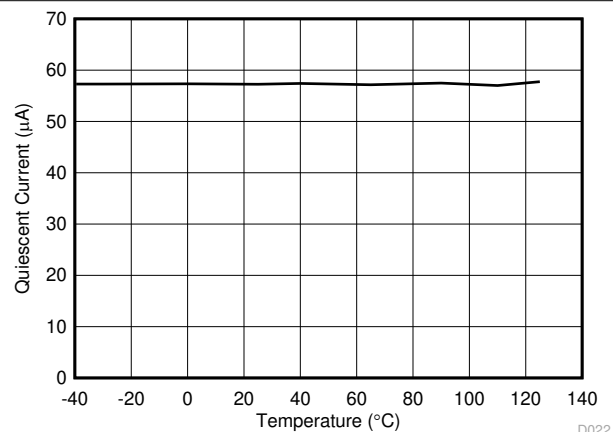
at  $T_A = 25^\circ\text{C}$ ,  $V_+ = 2.75\text{ V}$ ,  $V_- = -2.75\text{ V}$ ,  $R_L = 10\text{ k}\Omega$  connected to  $V_S / 2$ ,  $V_{CM} = V_S / 2$ , and  $V_{OUT} = V_S / 2$  (unless otherwise noted)

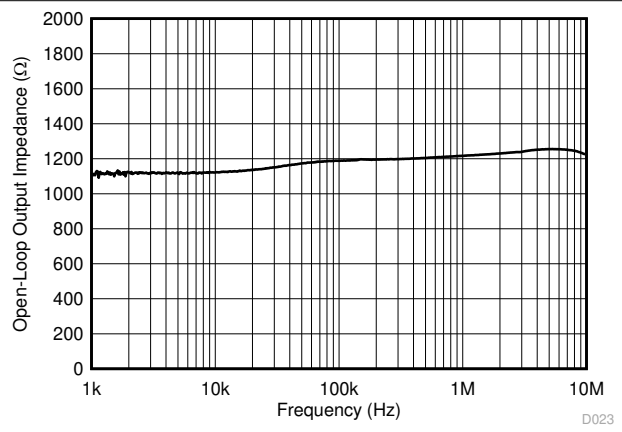

图 6-19. Small Signal Overshoot vs Capacitive Load



图 6-20. Small Signal Overshoot vs Capacitive Load

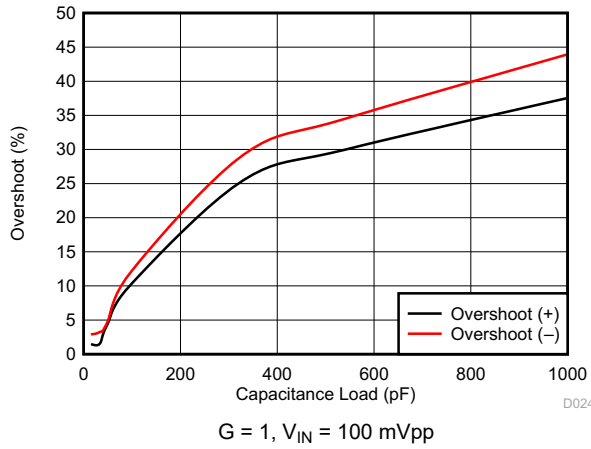

图 6-21. Phase Margin vs Capacitive Load

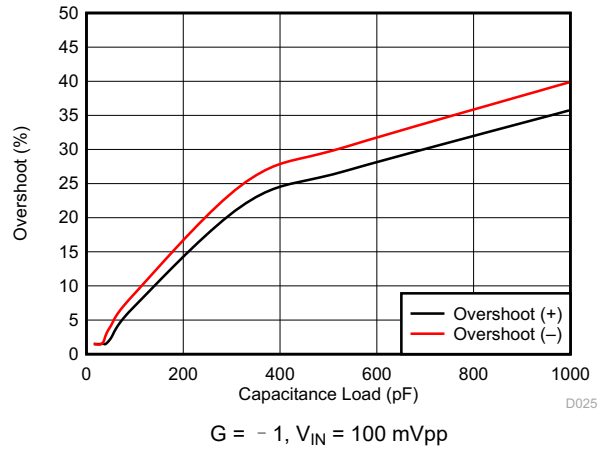

图 6-22. No Phase Reversal

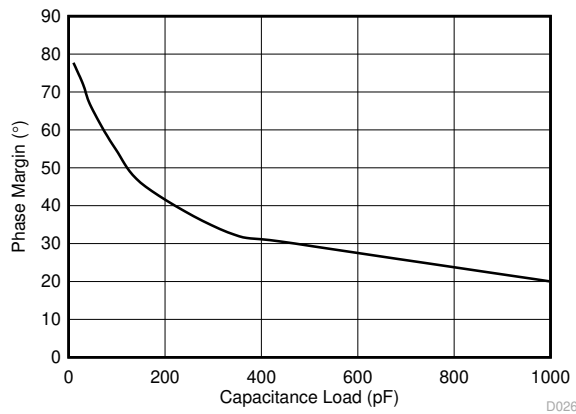

图 6-23. Overload Recovery

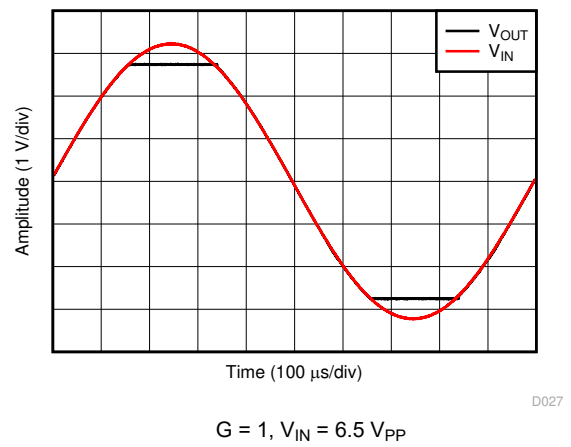

图 6-24. Small-Signal Step Response

## 6.8 Typical Characteristics (continued)

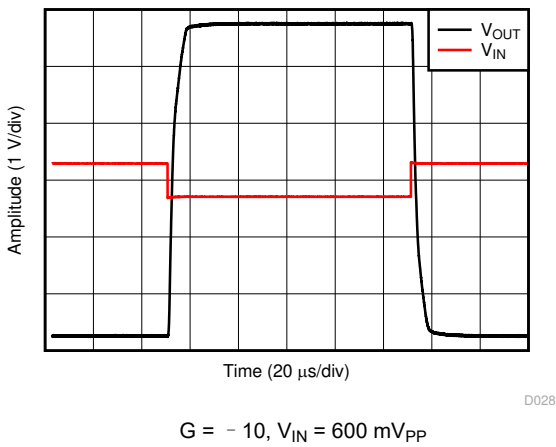
at  $T_A = 25^\circ\text{C}$ ,  $V_+ = 2.75\text{ V}$ ,  $V_- = -2.75\text{ V}$ ,  $R_L = 10\text{ k}\Omega$  connected to  $V_S / 2$ ,  $V_{CM} = V_S / 2$ , and  $V_{OUT} = V_S / 2$  (unless otherwise noted)

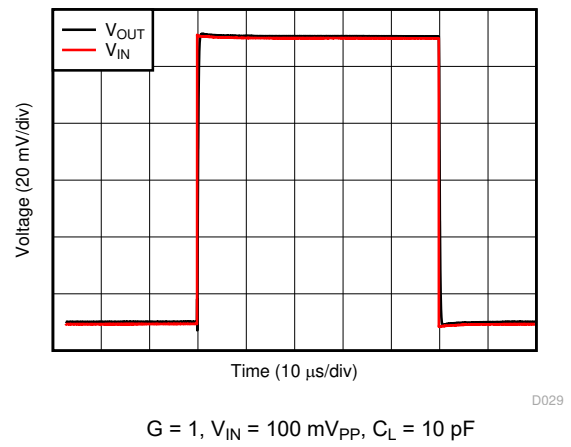
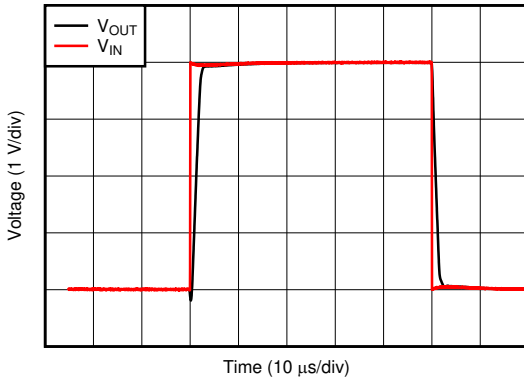

$G = 1$ ,  $V_{IN} = 4\text{ V}_{PP}$ ,  $C_L = 10\text{ pF}$

图 6-25. Large-Signal Step Response

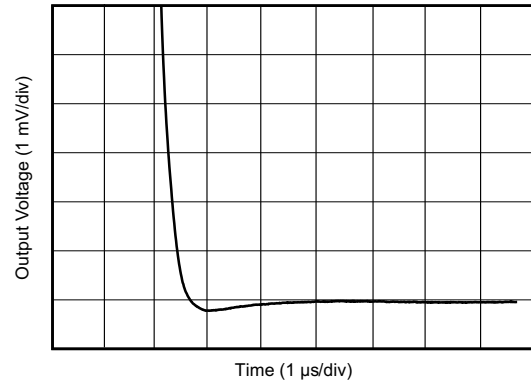

$G = 1$ ,  $C_L = 100\text{ pF}$ , 2-V step

图 6-26. Large-Signal Settling Time (Negative)

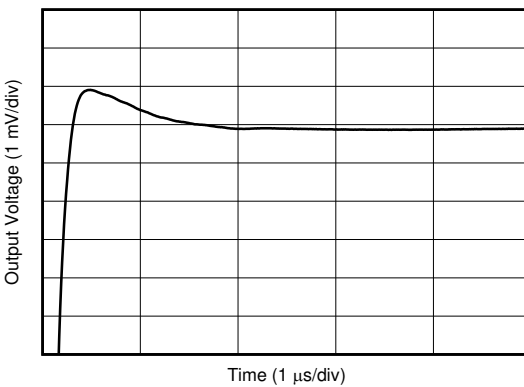

$G = 1$ ,  $C_L = 100\text{ pF}$ , 2-V step

图 6-27. Large-Signal Settling Time (Positive)



图 6-28. Short-Circuit Current vs Temperature



图 6-29. Maximum Output Voltage vs Frequency

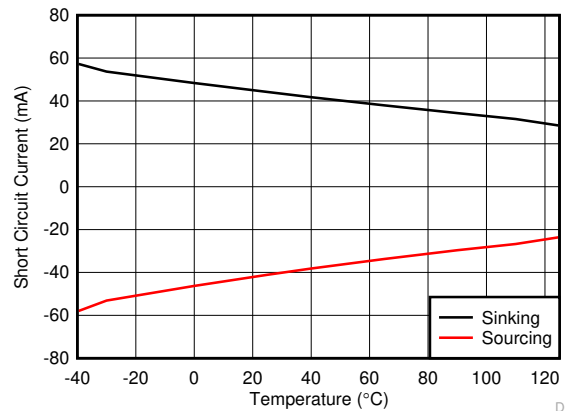

图 6-30. Electromagnetic Interference Rejection Ratio Referred to Noninverting Input (EMIRR+) vs Frequency

## 6.8 Typical Characteristics (continued)

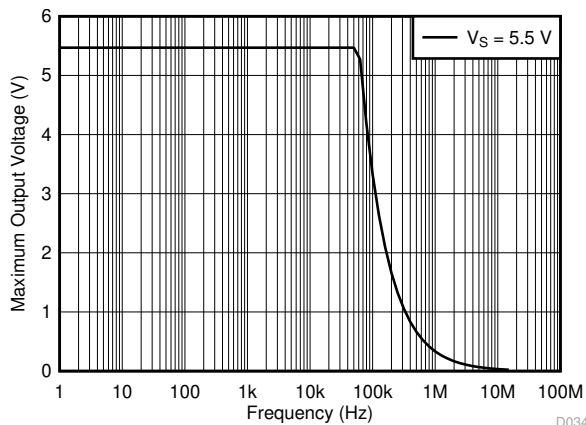
at  $T_A = 25^\circ\text{C}$ ,  $V_+ = 2.75\text{ V}$ ,  $V_- = -2.75\text{ V}$ ,  $R_L = 10\text{ k}\Omega$  connected to  $V_S / 2$ ,  $V_{CM} = V_S / 2$ , and  $V_{OUT} = V_S / 2$  (unless otherwise noted)

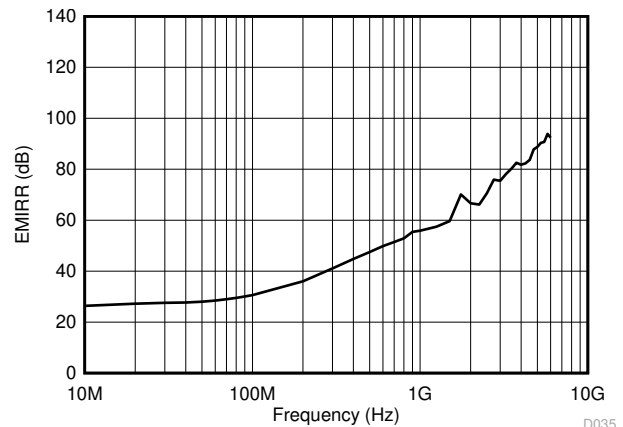

图 6-31. Channel Separation

## 7 Detailed Description

### 7.1 Overview

The LMV3xxA-Q1 is a family of low-power, rail-to-rail output op amps. These devices operate from 2.5 V to 5.5 V, are unity-gain stable, and are designed for a wide range of general-purpose applications. The input common-mode voltage range includes the negative rail and allows the LMV3xxA-Q1 family to be used in many single-supply applications. Rail-to-rail output swing significantly increases dynamic range, especially in low-supply applications, and makes the family of devices an excellent choice for driving sampling analog-to-digital converters (ADCs).

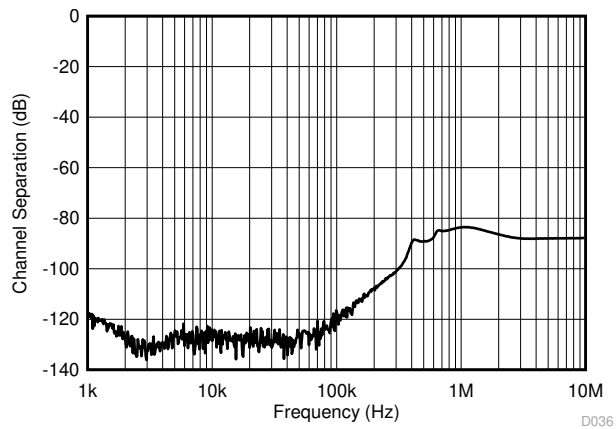
### 7.2 Functional Block Diagram

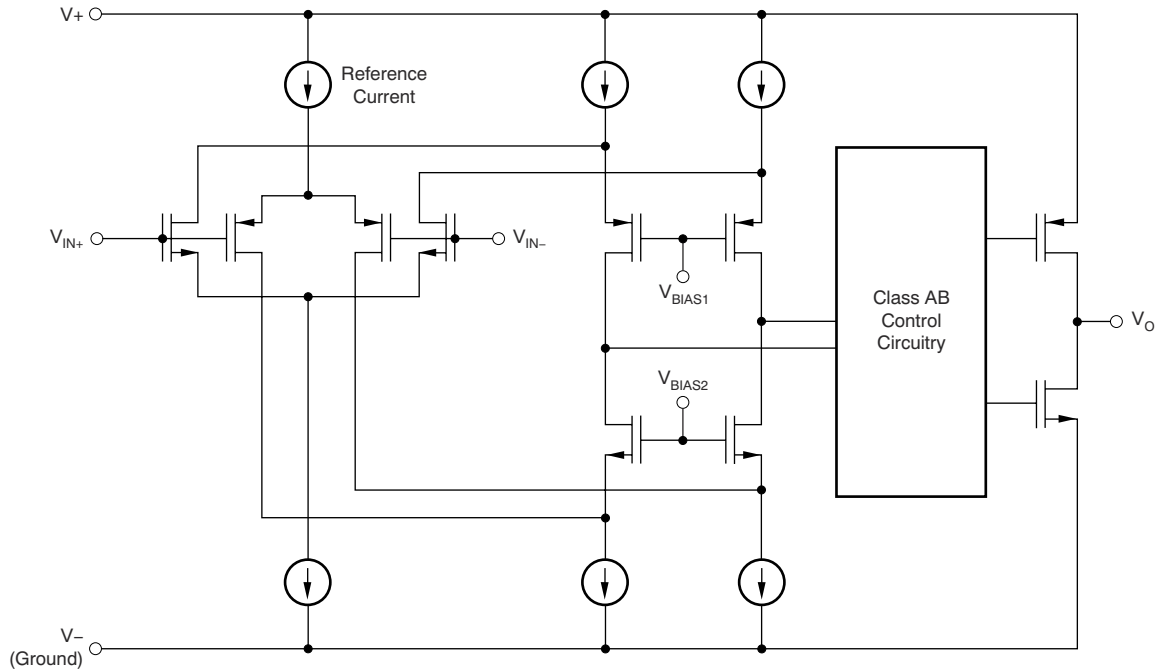

## 7.3 Feature Description

### 7.3.1 Operating Voltage

The LMV3xxA-Q1 family of op amps are for operation from 2.5 V to 5.5 V. In addition, many specifications such as input offset voltage, quiescent current, offset current, and short circuit current apply from  $-40^{\circ}\text{C}$  to  $125^{\circ}\text{C}$ . Parameters that vary significantly with operating voltages or temperature are shown in the [Typical Characteristics](#) section.

### 7.3.2 Input Common Mode Range

The input common-mode voltage range of the LMV3xxA-Q1 family extends 100 mV beyond the negative supply rail and within 1 V below the positive rail for the full supply voltage range of 2.5 V to 5.5 V. This performance is achieved with a P-channel differential pair, as shown in the [Functional Block Diagram](#). Additionally, a complementary N-channel differential pair has been included in parallel to eliminate issues with phase reversal that are common with previous generations of op amps. However, the N-channel pair is not optimized for operation. TI recommends limiting any voltages applied at the inputs to less than  $V_{\text{CC}} - 1\text{ V}$  to make sure that the op amp conforms to the specifications detailed in the [Electrical Characteristics](#) table.

### 7.3.3 Rail-to-Rail Output

Designed as a low-power, low-voltage operational amplifier, the LMV3xxA-Q1 family delivers a robust output drive capability. A class-AB output stage with common-source transistors achieves full rail-to-rail output swing capability. For resistive loads of  $10\text{ k}\Omega$ , the output swings to within 20 mV of either supply rail, regardless of the applied power-supply voltage. Different load conditions change the ability of the amplifier to swing close to the rails.

### 7.3.4 Overload Recovery

Overload recovery is defined as the time required for the operational amplifier output to recover from a saturated state to a linear state. The output devices of the operational amplifier enter a saturation region when the output voltage exceeds the rated operating voltage, because of the high input voltage or the high gain. After the device enters the saturation region, the charge carriers in the output devices require time to return to the linear state. After the charge carriers return to the linear state, the device begins to slew at the specified slew rate. Therefore, the propagation delay (in case of an overload condition) is the sum of the overload recovery time and the slew time. The overload recovery time for the LMV3xxA-Q1 family is approximately 850 ns.

## 7.4 Device Functional Modes

The LMV3xxA-Q1 family has a single functional mode. The devices are powered on as long as the power-supply voltage is between 2.5 V ( $\pm 1.25\text{ V}$ ) and 5.5 V ( $\pm 2.75\text{ V}$ ).

## 8 Application and Implementation

### 备注

以下应用部分中的信息不属于 TI 器件规格的范围，TI 不担保其准确性和完整性。TI 的客户应负责确定器件是否适用于其应用。客户应验证并测试其设计，以确保系统功能。

### 8.1 Application Information

The LMV3xxA-Q1 family of low-power, rail-to-rail output operational amplifiers is specifically designed for portable applications. The devices operate from 2.5 V to 5.5 V, are unity-gain stable, and are designed for for a wide range of general-purpose applications. The class AB output stage is capable of driving less than or equal to 10-k $\Omega$  loads connected to any point between V+ and V-. The input common-mode voltage range includes the negative rail, and allows the LMV3xxA-Q1 devices to be used in many single-supply applications.

### 8.2 Typical Application

#### 8.2.1 LMV3xxA-Q1 Low-Side, Current Sensing Application

图 8-1 shows the LMV3xxA-Q1 configured in a low-side current sensing application.



图 8-1. LMV3xxA-Q1 in a Low-Side, Current-Sensing Application



### 8.2.1.1 Design Requirements

The design requirements for this design are:

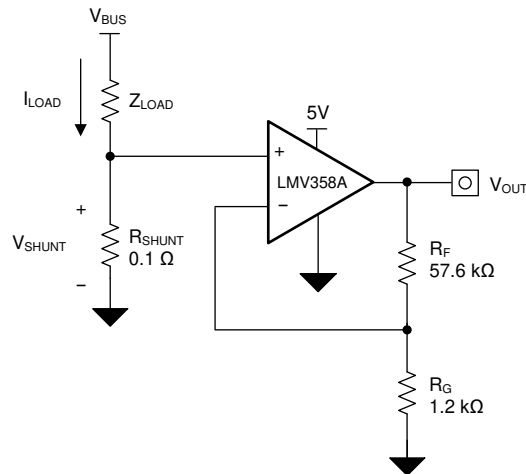
- Load current: 0 A to 1 A
- Output voltage: 4.9 V
- Maximum shunt voltage: 100 mV

### 8.2.1.2 Detailed Design Procedure

The transfer function of the circuit in [图 8-1](#) is given in [方程式 1](#).

$$V_{OUT} = I_{LOAD} \times R_{SHUNT} \times \text{Gain} \quad (1)$$

The load current ( $I_{LOAD}$ ) produces a voltage drop across the shunt resistor ( $R_{SHUNT}$ ). The load current is set from 0 A to 1 A. To keep the shunt voltage below 100 mV at maximum load current, the largest shunt resistor is shown using [方程式 2](#).

$$R_{SHUNT} = \frac{V_{SHUNT\_MAX}}{I_{LOAD\_MAX}} = \frac{100\text{mV}}{1\text{A}} = 100\text{m}\Omega \quad (2)$$

Using [方程式 2](#),  $R_{SHUNT}$  is calculated to be 100 m $\Omega$ . The voltage drop produced by  $I_{LOAD}$  and  $R_{SHUNT}$  is amplified by the LMV3xxA-Q1 to produce an output voltage of approximately 0 V to 4.9 V. The gain needed by the LMV3xxA-Q1 to produce the necessary output voltage is calculated using [方程式 3](#).

$$\text{Gain} = \frac{(V_{OUT\_MAX} - V_{OUT\_MIN})}{(V_{IN\_MAX} - V_{IN\_MIN})} \quad (3)$$

Using [方程式 3](#), the required gain is calculated to be 49 V/V, which is set with resistors  $R_F$  and  $R_G$ . [方程式 4](#) sizes the resistors  $R_F$  and  $R_G$ , to set the gain of the LMV3xxA-Q1 to 49 V/V.

$$\text{Gain} = 1 + \frac{(R_F)}{(R_G)} \quad (4)$$

Selecting  $R_F$  as 57.6 k $\Omega$  and  $R_G$  as 1.2 k $\Omega$  provides a combination that equals 49 V/V. [图 8-2](#) shows the measured transfer function of the circuit shown in [图 8-1](#). Notice that the gain is only a function of the feedback and gain resistors. This gain is adjusted by varying the ratio of the resistors and the actual resistors values are determined by the impedance levels that the designer wants to establish. The impedance level determines the current drain, the effect that stray capacitance has, and a few other behaviors. There is no best impedance selection that works for every system, you must choose an impedance that is an excellent choice for your system parameters.

### 8.2.1.3 Application Curve



图 8-2. Low-Side, Current-Sense Transfer Function

### 8.2.2 Single-Supply Photodiode Amplifier

Photodiodes are used in many applications to convert light signals to electrical signals. The current through the photodiode is proportional to the photon energy absorbed, and is commonly in the range of a few hundred picoamps to a few tens of microamps. An amplifier in a transimpedance configuration is typically used to convert the low-level photodiode current to a voltage signal for processing in an MCU. The circuit shown in [图 8-3](#) is an example of a single-supply photodiode amplifier circuit using the LMV358A-Q1.

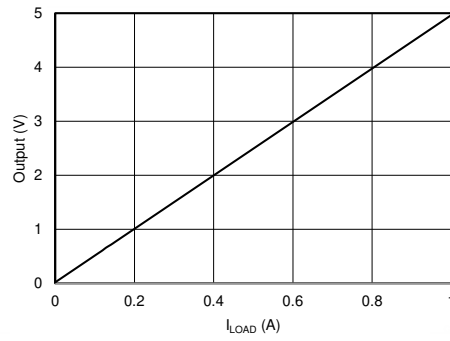
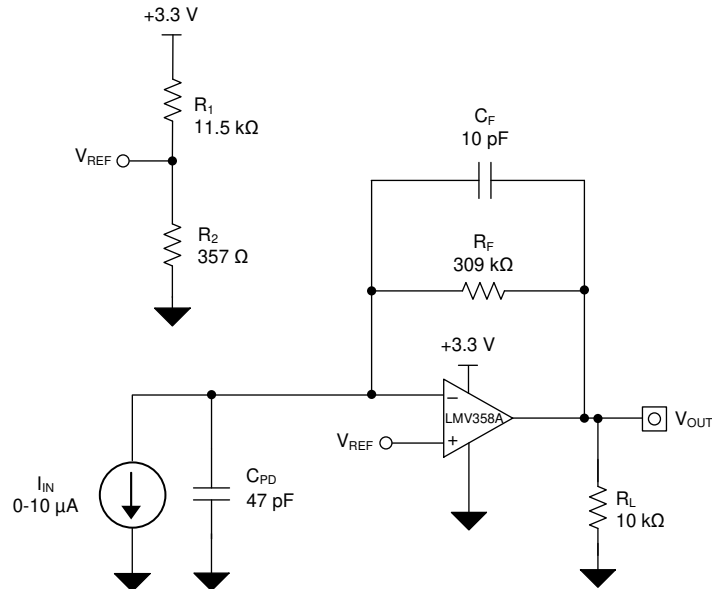

**图 8-3. Single-Supply Photodiode Amplifier Circuit**

### 8.2.2.1 Design Requirements

The design requirements for this design are:

- Supply voltage: 3.3 V
- Input: 0  $\mu$ A to 10  $\mu$ A
- Output: 0.1 V to 3.2 V
- Bandwidth: 50 kHz

### 8.2.2.2 Detailed Design Procedure

The transfer function between the output voltage ( $V_{OUT}$ ), the input current, ( $I_{IN}$ ) and the reference voltage ( $V_{REF}$ ) is defined in [方程式 5](#).

$$V_{OUT} = I_{IN} \times R_F + V_{REF} \quad (5)$$

Where:

$$V_{REF} = V_+ \times \left( \frac{R_1 \times R_2}{R_1 + R_2} \right) \quad (6)$$

Set  $V_{REF}$  to 100 mV to meet the minimum output voltage level by setting R1 and R2 to meet the required ratio calculated in [方程式 7](#).

$$\frac{V_{REF}}{V_+} = \frac{0.1 \text{ V}}{3.3 \text{ V}} = 0.0303 \quad (7)$$

The closest resistor ratio to meet this ratio sets R1 to 11.5 k $\Omega$  and R2 to 357  $\Omega$ .

The required feedback resistance can be calculated based on the input current and desired output voltage.

$$R_F = \frac{V_{OUT} - V_{REF}}{I_{IN}} = \frac{3.2 \text{ V} - 0.1 \text{ V}}{10 \mu\text{A}} = 310 \frac{\text{kV}}{\text{A}} \approx 309 \text{ k}\Omega \quad (8)$$

Calculate the value for the feedback capacitor based on  $R_F$  and the desired -3-dB bandwidth, ( $f_{-3dB}$ ) using [方程式 9](#).

$$C_F = \frac{1}{2 \times \pi \times R_F \times f_{-3dB}} = \frac{1}{2 \times \pi \times 309 \text{ k}\Omega \times 50 \text{ kHz}} = 10.3 \text{ pF} \approx 10 \text{ pF} \quad (9)$$

The minimum op amp bandwidth required for this application is based on the value of  $R_F$ ,  $C_F$ , and the capacitance on the INx - pin of the LMV358A-Q1 which is equal to the sum of the photodiode shunt capacitance, (CPD) the common-mode input capacitance, (CCM) and the differential input capacitance (CD) as [方程式 10](#) shows.

$$C_{IN} = C_{PD} + C_{CM} + C_D = 47 \text{ pF} + 5 \text{ pF} + 1 \text{ pF} = 53 \text{ pF} \quad (10)$$

The minimum op amp bandwidth is calculated in [方程式 11](#).

$$f_{-BGW} \geq \frac{C_{IN} + C_F}{2 \times \pi \times R_F \times C_F^2} \geq 324 \text{ kHz} \quad (11)$$

The 1-MHz bandwidth of the LMV3xxA-Q1 meets the minimum bandwidth requirement and remains stable in this application configuration.

### 8.2.2.3 Application Curves

The measured current-to-voltage transfer function for the photodiode amplifier circuit is shown in 图 8-4. The measured performance of the photodiode amplifier circuit is shown in 图 8-5.

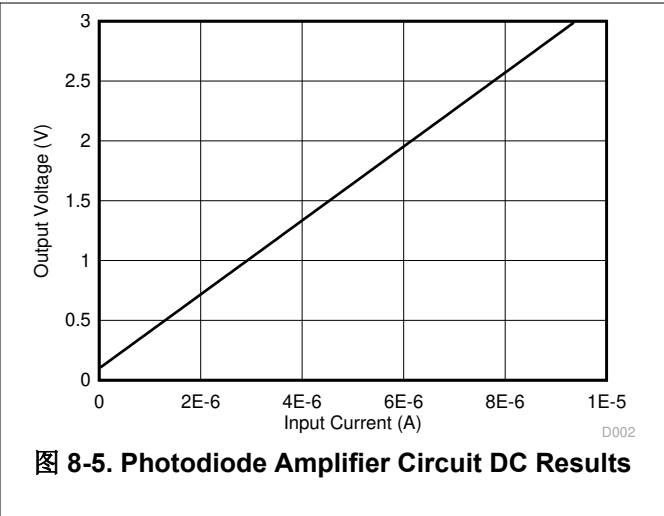
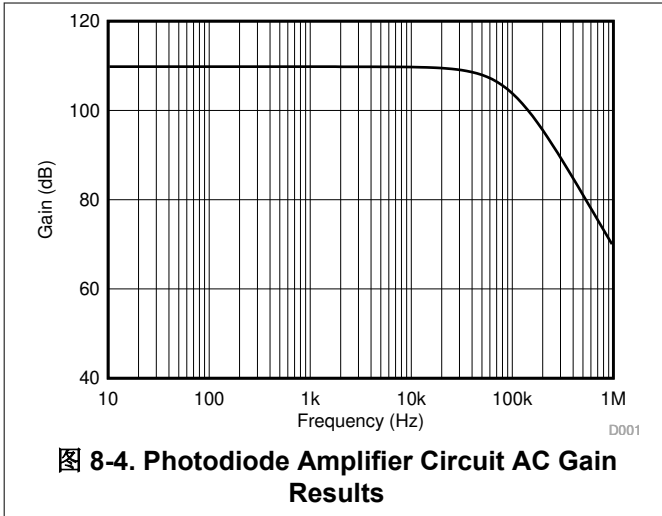

## 9 Power Supply Recommendations

The LMV3xxA-Q1 family is specified for operation from 2.5 V to 5.5 V ( $\pm 1.25$  V to  $\pm 2.75$  V); many specifications apply from  $-40^{\circ}\text{C}$  to  $125^{\circ}\text{C}$ . The [Typical Characteristics](#) section presents parameters that may exhibit significant variance with regard to operating voltage or temperature.

### CAUTION

Supply voltages larger than 6 V may permanently damage the device; see the [Absolute Maximum Ratings](#) table.

Place 0.1- $\mu\text{F}$  bypass capacitors close to the power-supply pins to reduce coupling errors from noisy or high-impedance power supplies. For more detailed information on bypass capacitor placement, see the [Layout Guidelines](#) section.

### 9.1 Input and ESD Protection

The LMV3xxA-Q1 family incorporates internal ESD protection circuits on all pins. For input and output pins, this protection primarily consists of current-steering diodes connected between the input and power-supply pins. These ESD protection diodes provide in-circuit, input overdrive protection, as long as the current is limited to 10 mA. [Figure 9-1](#) shows how a series input resistor can be added to the driven input to limit the input current. The added resistor contributes thermal noise at the amplifier input and the value must be kept to a minimum in noise-sensitive applications.

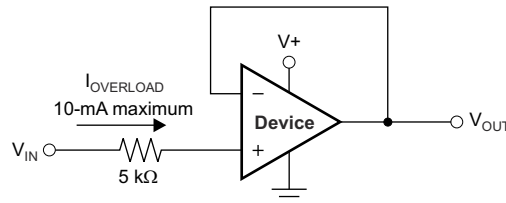

**图 9-1. Input Current Protection**

## 10 Layout

### 10.1 Layout Guidelines

For best operational performance of the device, use good printed circuit board (PCB) layout practices, including:

- Noise can propagate into analog circuitry through the power connections of the board and propagate to the power pins of the op amp itself. Bypass capacitors are used to reduce the coupled noise by providing a low-impedance path to ground.
  - Connect low-ESR, 0.1- $\mu\text{F}$  ceramic bypass capacitors between each supply pin and ground, placed as close to the device as possible. A single bypass capacitor from  $V+$  to ground is adequate for single-supply applications.
- Separate grounding for analog and digital portions of circuitry is one of the simplest and most effective methods of noise suppression. One or more layers on multilayer PCBs are usually devoted to ground planes. A ground plane helps distribute heat and reduces electromagnetic interference (EMI) noise pickup. Take care to physically separate digital and analog grounds, paying attention to the flow of the ground current.
- To reduce parasitic coupling, run the input traces as far away from the supply or output traces as possible. If these traces cannot be kept separate, crossing the sensitive trace at a 90 degree angle is much better as opposed to running the traces in parallel with the noisy trace.
- Place the external components as close to the device as possible, as shown in 图 10-2. Keeping  $R_F$  and  $R_G$  close to the inverting input minimizes parasitic capacitance.
- Keep the length of input traces as short as possible. Remember that the input traces are the most sensitive part of the circuit.
- Consider a driven, low-impedance guard ring around the critical traces. A guard ring may significantly reduce leakage currents from nearby traces that are at different potentials.
- Cleaning the PCB following board assembly is recommended for best performance.
- Any precision integrated circuit can experience performance shifts resulting from moisture ingress into the plastic package. Following any aqueous PCB cleaning process, baking the PCB assembly is recommended to remove moisture introduced into the device packaging during the cleaning process. A low-temperature, post-cleaning bake at 85°C for 30 minutes is sufficient for most circumstances.

### 10.2 Layout Example



图 10-1. Schematic Representation for Figure 10-2



图 10-2. Layout Example

## 11 Device and Documentation Support

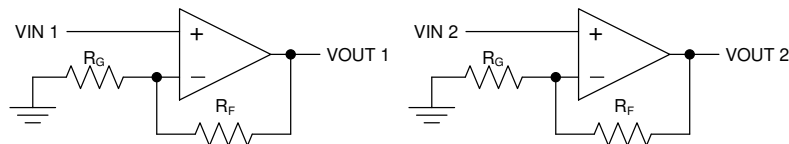
### 11.1 Documentation Support

#### 11.1.1 Related Documentation

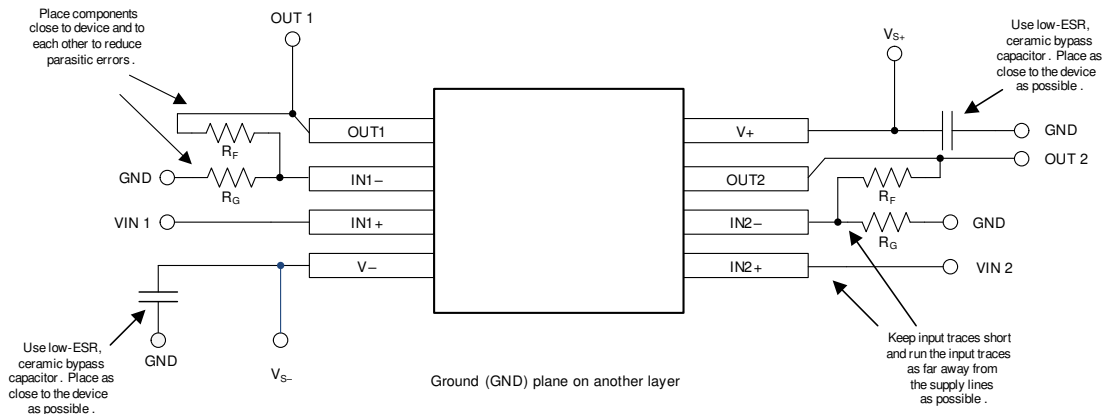
For related documentation, see the following:

- Texas Instruments, [EMI Rejection Ratio of Operational Amplifiers](#)

### 11.2 Related Links

The table below lists quick access links. Categories include technical documents, support and community resources, tools and software, and quick access to order now.

表 11-1. Related Links

PARTS	PRODUCT FOLDER	ORDER NOW	TECHNICAL DOCUMENTS	TOOLS & SOFTWARE	SUPPORT & COMMUNITY
LMV321A-Q1	<a href="#">Click here</a>	<a href="#">Click here</a>	<a href="#">Click here</a>	<a href="#">Click here</a>	<a href="#">Click here</a>
LMV358A-Q1	<a href="#">Click here</a>	<a href="#">Click here</a>	<a href="#">Click here</a>	<a href="#">Click here</a>	<a href="#">Click here</a>
LMV324A-Q1	<a href="#">Click here</a>	<a href="#">Click here</a>	<a href="#">Click here</a>	<a href="#">Click here</a>	<a href="#">Click here</a>

### 11.3 Receiving Notification of Documentation Updates

To receive notification of documentation updates, navigate to the device product folder on ti.com. In the upper right corner, click on *Alert me* to register and receive a weekly digest of any product information that has changed. For change details, review the revision history included in any revised document.

### 11.4 支持资源

TI E2E™ 支持论坛是工程师的重要参考资料，可直接从专家获得快速、经过验证的解答和设计帮助。搜索现有解答或提出自己的问题可获得所需的快速设计帮助。

链接的内容由各个贡献者“按原样”提供。这些内容并不构成 TI 技术规范，并且不一定反映 TI 的观点；请参阅 TI 的《使用条款》。

### 11.5 Trademarks

TI E2E™ is a trademark of Texas Instruments.  
所有商标均为其各自所有者的财产。

### 11.6 静电放电警告



静电放电 (ESD) 会损坏这个集成电路。德州仪器 (TI) 建议通过适当的预防措施处理所有集成电路。如果不遵守正确的处理和安装程序，可能会损坏集成电路。

ESD 的损坏小至导致微小的性能降级，大至整个器件故障。精密的集成电路可能更容易受到损坏，这是因为非常细微的参数更改都可能会导致器件与其发布的规格不相符。

### 11.7 术语表

TI 术语表 本术语表列出并解释了术语、首字母缩略词和定义。

## 12 Mechanical, Packaging, and Orderable Information

The following pages include mechanical, packaging, and orderable information. This information is the most-current data available for the designated devices. This data is subject to change without notice and without revision of this document. For browser-based versions of this data sheet, see the left-hand navigation pane.



## PACKAGING INFORMATION

Orderable Device	Status (1)	Package Type	Package Drawing	Pins	Package Qty	Eco Plan (2)	Lead finish/ Ball material (6)	MSL Peak Temp (3)	Op Temp (°C)	Device Marking (4/5)	Samples
LMV321AQDCKRQ1	ACTIVE	SC70	DCK	5	3000	RoHS & Green	NIPDAU	Level-1-260C-UNLIM	-40 to 125	1N1	<a href="#">Samples</a>
LMV324AQDRQ1	ACTIVE	SOIC	D	14	2500	RoHS & Green	NIPDAU	Level-2-260C-1 YEAR	-40 to 125	LM324Q	<a href="#">Samples</a>
LMV324AQDYRQ1	ACTIVE	SOT-23-THIN	DYY	14	3000	RoHS & Green	NIPDAU	Level-1-260C-UNLIM	-40 to 125	LM324Q	<a href="#">Samples</a>
LMV324AQPWRQ1	ACTIVE	TSSOP	PW	14	3000	RoHS & Green	NIPDAU	Level-1-260C-UNLIM	-40 to 125	LM324A	<a href="#">Samples</a>
LMV358AQDGKRQ1	ACTIVE	VSSOP	DGK	8	2500	RoHS & Green	NIPDAU	Level-1-260C-UNLIM	-40 to 125	27FT	<a href="#">Samples</a>
LMV358AQDRQ1	ACTIVE	SOIC	D	8	2500	RoHS & Green	NIPDAU	Level-1-260C-UNLIM	-40 to 125	L358AQ	<a href="#">Samples</a>
PLMV321AQDCKRQ1	ACTIVE	SC70	DCK	5	3000	RoHS & Green	NIPDAU	Level-1-260C-UNLIM	-40 to 125	1MX	<a href="#">Samples</a>

(1) The marketing status values are defined as follows:

**ACTIVE:** Product device recommended for new designs.

**LIFEBUY:** TI has announced that the device will be discontinued, and a lifetime-buy period is in effect.

**NRND:** Not recommended for new designs. Device is in production to support existing customers, but TI does not recommend using this part in a new design.

**PREVIEW:** Device has been announced but is not in production. Samples may or may not be available.

**OBSOLETE:** TI has discontinued the production of the device.

(2) **RoHS:** TI defines "RoHS" to mean semiconductor products that are compliant with the current EU RoHS requirements for all 10 RoHS substances, including the requirement that RoHS substance do not exceed 0.1% by weight in homogeneous materials. Where designed to be soldered at high temperatures, "RoHS" products are suitable for use in specified lead-free processes. TI may reference these types of products as "Pb-Free".

**RoHS Exempt:** TI defines "RoHS Exempt" to mean products that contain lead but are compliant with EU RoHS pursuant to a specific EU RoHS exemption.

**Green:** TI defines "Green" to mean the content of Chlorine (Cl) and Bromine (Br) based flame retardants meet JS709B low halogen requirements of <=1000ppm threshold. Antimony trioxide based flame retardants must also meet the <=1000ppm threshold requirement.

(3) MSL, Peak Temp. - The Moisture Sensitivity Level rating according to the JEDEC industry standard classifications, and peak solder temperature.

(4) There may be additional marking, which relates to the logo, the lot trace code information, or the environmental category on the device.

(5) Multiple Device Markings will be inside parentheses. Only one Device Marking contained in parentheses and separated by a "~" will appear on a device. If a line is indented then it is a continuation of the previous line and the two combined represent the entire Device Marking for that device.

<sup>(6)</sup> Lead finish/Ball material - Orderable Devices may have multiple material finish options. Finish options are separated by a vertical ruled line. Lead finish/Ball material values may wrap to two lines if the finish value exceeds the maximum column width.

**Important Information and Disclaimer:**The information provided on this page represents TI's knowledge and belief as of the date that it is provided. TI bases its knowledge and belief on information provided by third parties, and makes no representation or warranty as to the accuracy of such information. Efforts are underway to better integrate information from third parties. TI has taken and continues to take reasonable steps to provide representative and accurate information but may not have conducted destructive testing or chemical analysis on incoming materials and chemicals. TI and TI suppliers consider certain information to be proprietary, and thus CAS numbers and other limited information may not be available for release.

In no event shall TI's liability arising out of such information exceed the total purchase price of the TI part(s) at issue in this document sold by TI to Customer on an annual basis.

**OTHER QUALIFIED VERSIONS OF LMV321A-Q1, LMV324A-Q1, LMV358A-Q1 :**

- Catalog : [LMV321A](#), [LMV324A](#), [LMV358A](#)

NOTE: Qualified Version Definitions:

- Catalog - TI's standard catalog product

**TAPE AND REEL INFORMATION**

**QUADRANT ASSIGNMENTS FOR PIN 1 ORIENTATION IN TAPE**

\*All dimensions are nominal

Device	Package Type	Package Drawing	Pins	SPQ	Reel Diameter (mm)	Reel Width W1 (mm)	A0 (mm)	B0 (mm)	K0 (mm)	P1 (mm)	W (mm)	Pin1 Quadrant
LMV321AQDCKRQ1	SC70	DCK	5	3000	178.0	9.0	2.4	2.5	1.2	4.0	8.0	Q3
LMV324AQDRQ1	SOIC	D	14	2500	330.0	16.4	6.5	9.0	2.1	8.0	16.0	Q1
LMV324AQDYRQ1	SOT-23-THIN	DYY	14	3000	330.0	12.4	4.8	3.6	1.6	8.0	12.0	Q3
LMV324AQPWRQ1	TSSOP	PW	14	3000	330.0	12.4	6.9	5.6	1.6	8.0	12.0	Q1
LMV358AQDGKRQ1	VSSOP	DGK	8	2500	330.0	12.4	5.3	3.4	1.4	8.0	12.0	Q1
LMV358AQDRQ1	SOIC	D	8	2500	330.0	12.4	6.4	5.2	2.1	8.0	12.0	Q1

**TAPE AND REEL BOX DIMENSIONS**

\*All dimensions are nominal

Device	Package Type	Package Drawing	Pins	SPQ	Length (mm)	Width (mm)	Height (mm)
LMV321AQDCKRQ1	SC70	DCK	5	3000	190.0	190.0	30.0
LMV324AQDRQ1	SOIC	D	14	2500	356.0	356.0	35.0
LMV324AQDYRQ1	SOT-23-THIN	DYY	14	3000	336.6	336.6	31.8
LMV324AQPWRQ1	TSSOP	PW	14	3000	356.0	356.0	35.0
LMV358AQDGKRQ1	VSSOP	DGK	8	2500	366.0	364.0	50.0
LMV358AQDRQ1	SOIC	D	8	2500	356.0	356.0	35.0

DCK (R-PDSO-G5)

PLASTIC SMALL-OUTLINE PACKAGE



- NOTES:
- A. All linear dimensions are in millimeters.
  - B. This drawing is subject to change without notice.
  - C. Body dimensions do not include mold flash or protrusion. Mold flash and protrusion shall not exceed 0.15 per side.
  - D. Falls within JEDEC MO-203 variation AA.

DCK (R-PDSO-G5)

PLASTIC SMALL OUTLINE



- NOTES:
- All linear dimensions are in millimeters.
  - This drawing is subject to change without notice.
  - Customers should place a note on the circuit board fabrication drawing not to alter the center solder mask defined pad.
  - Publication IPC-7351 is recommended for alternate designs.
  - Laser cutting apertures with trapezoidal walls and also rounding corners will offer better paste release. Customers should contact their board assembly site for stencil design recommendations. Example stencil design based on a 50% volumetric metal load solder paste. Refer to IPC-7525 for other stencil recommendations.

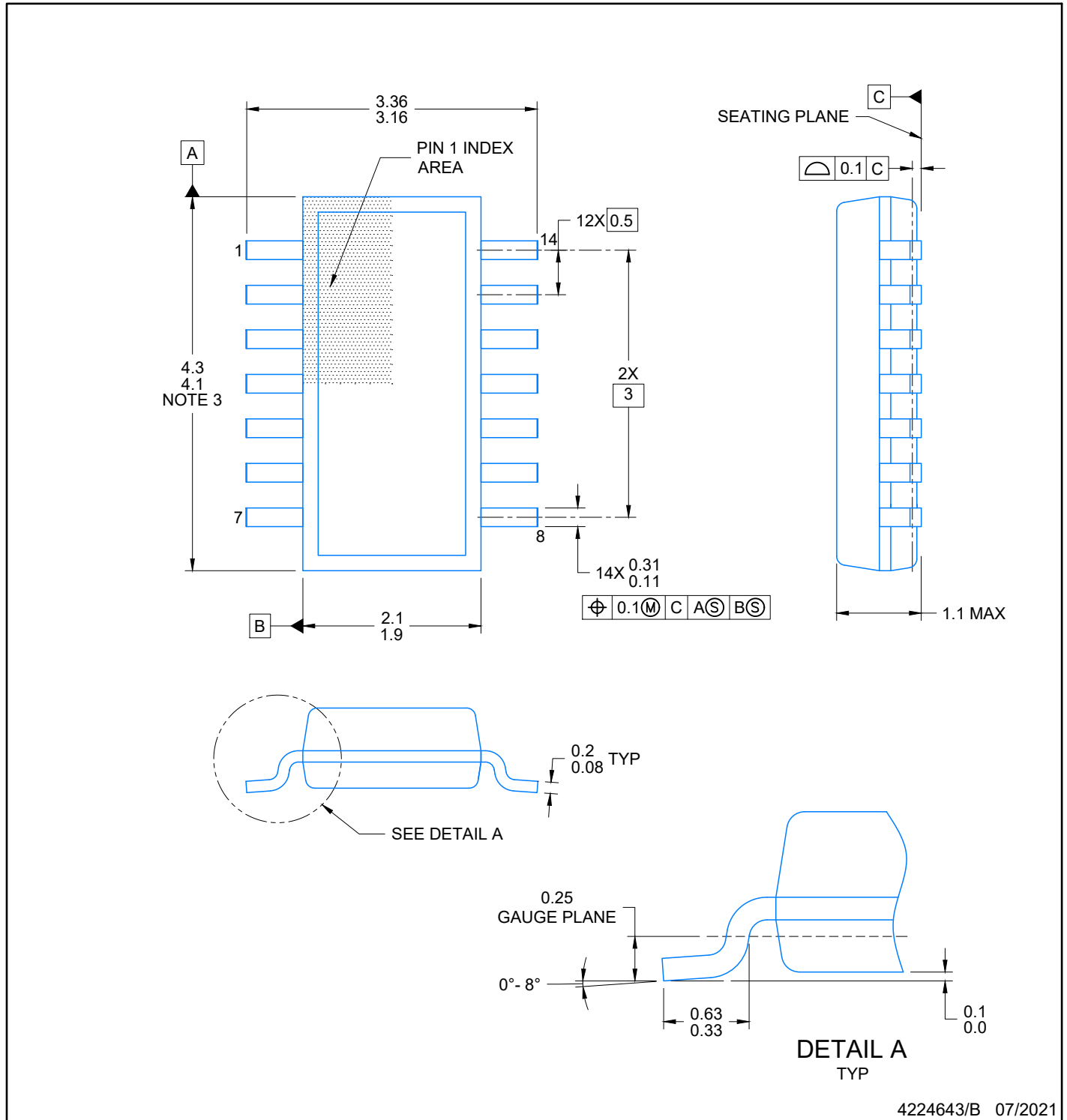

4224643/B 07/2021

**NOTES:**

1. All linear dimensions are in millimeters. Any dimensions in parenthesis are for reference only. Dimensioning and tolerancing per ASME Y14.5M.
2. This drawing is subject to change without notice.
3. This dimension does not include mold flash, protrusions, or gate burrs. Mold flash, protrusions, or gate burrs shall not exceed 0.15 per side.
4. This dimension does not include interlead flash. Interlead flash shall not exceed 0.50 per side.
5. Reference JEDEC Registration MO-345, Variation AB



LAND PATTERN EXAMPLE  
EXPOSED METAL SHOWN  
SCALE: 20X



4224643/B 07/2021

NOTES: (continued)

- 6. Publication IPC-7351 may have alternate designs.
- 7. Solder mask tolerances between and around signal pads can vary based on board fabrication site.



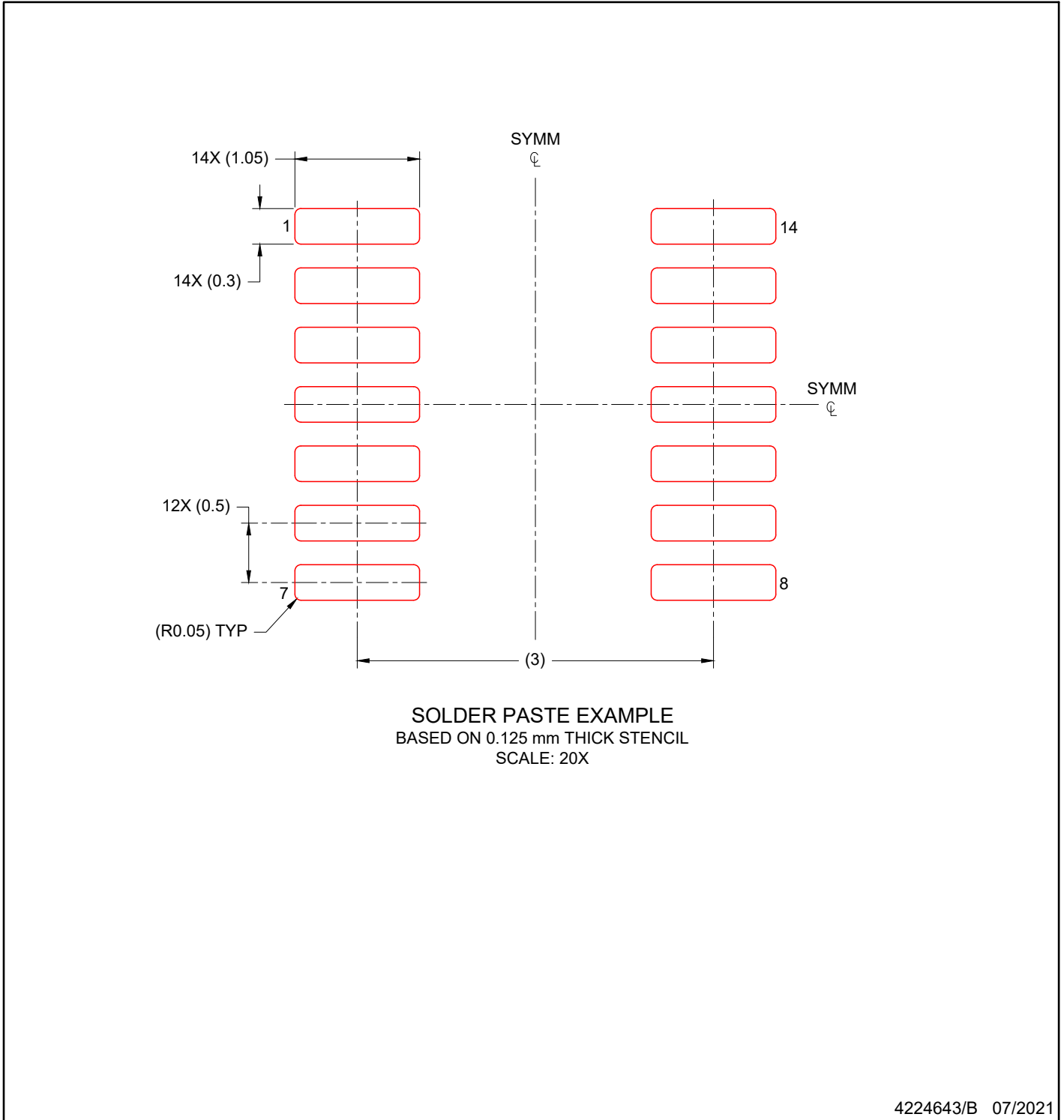

NOTES: (continued)

- 8. Laser cutting apertures with trapezoidal walls and rounded corners may offer better paste release. IPC-7525 may have alternate design recommendations.
- 9. Board assembly site may have different recommendations for stencil design.



D (R-PDSO-G14)

PLASTIC SMALL OUTLINE



4211283-3/E 08/12

- NOTES:
- All linear dimensions are in millimeters.
  - This drawing is subject to change without notice.
  - Publication IPC-7351 is recommended for alternate designs.
  - Laser cutting apertures with trapezoidal walls and also rounding corners will offer better paste release. Customers should contact their board assembly site for stencil design recommendations. Refer to IPC-7525 for other stencil recommendations.
  - Customers should contact their board fabrication site for solder mask tolerances between and around signal pads.

PW (R-PDSO-G14)

PLASTIC SMALL OUTLINE



- NOTES:
- A. All linear dimensions are in millimeters. Dimensioning and tolerancing per ASME Y14.5M-1994.
  - B. This drawing is subject to change without notice.
  - C. Body length does not include mold flash, protrusions, or gate burrs. Mold flash, protrusions, or gate burrs shall not exceed 0,15 each side.
  - D. Body width does not include interlead flash. Interlead flash shall not exceed 0,25 each side.
  - E. Falls within JEDEC MO-153

PW (R-PDSO-G14)

PLASTIC SMALL OUTLINE



4211284-2/G 08/15

- NOTES:
- A. All linear dimensions are in millimeters.
  - B. This drawing is subject to change without notice.
  - C. Publication IPC-7351 is recommended for alternate designs.
  - D. Laser cutting apertures with trapezoidal walls and also rounding corners will offer better paste release. Customers should contact their board assembly site for stencil design recommendations. Refer to IPC-7525 for other stencil recommendations.
  - E. Customers should contact their board fabrication site for solder mask tolerances between and around signal pads.



D0008A

# PACKAGE OUTLINE

SOIC - 1.75 mm max height

SMALL OUTLINE INTEGRATED CIRCUIT



## NOTES:

1. Linear dimensions are in inches [millimeters]. Dimensions in parenthesis are for reference only. Controlling dimensions are in inches. Dimensioning and tolerancing per ASME Y14.5M.
2. This drawing is subject to change without notice.
3. This dimension does not include mold flash, protrusions, or gate burrs. Mold flash, protrusions, or gate burrs shall not exceed  $.006$  [0.15] per side.
4. This dimension does not include interlead flash.
5. Reference JEDEC registration MS-012, variation AA.

# EXAMPLE BOARD LAYOUT

D0008A

SOIC - 1.75 mm max height

SMALL OUTLINE INTEGRATED CIRCUIT



LAND PATTERN EXAMPLE  
 EXPOSED METAL SHOWN  
 SCALE:8X



SOLDER MASK DETAILS

4214825/C 02/2019

NOTES: (continued)

6. Publication IPC-7351 may have alternate designs.

7. Solder mask tolerances between and around signal pads can vary based on board fabrication site.

# EXAMPLE STENCIL DESIGN

D0008A

SOIC - 1.75 mm max height

SMALL OUTLINE INTEGRATED CIRCUIT



SOLDER PASTE EXAMPLE  
BASED ON .005 INCH [0.125 MM] THICK STENCIL  
SCALE:8X

4214825/C 02/2019

NOTES: (continued)

8. Laser cutting apertures with trapezoidal walls and rounded corners may offer better paste release. IPC-7525 may have alternate design recommendations.
9. Board assembly site may have different recommendations for stencil design.



DGK (S-PDSO-G8)

PLASTIC SMALL-OUTLINE PACKAGE



4073329/E 05/06

- NOTES:
- A. All linear dimensions are in millimeters.
  - B. This drawing is subject to change without notice.
  - C. Body length does not include mold flash, protrusions, or gate burrs. Mold flash, protrusions, or gate burrs shall not exceed 0.15 per end.
  - D. Body width does not include interlead flash. Interlead flash shall not exceed 0.50 per side.
  - E. Falls within JEDEC MO-187 variation AA, except interlead flash.



- NOTES:
- A. All linear dimensions are in millimeters.
  - B. This drawing is subject to change without notice.
  - C. Publication IPC-7351 is recommended for alternate designs.
  - D. Laser cutting apertures with trapezoidal walls and also rounding corners will offer better paste release. Customers should contact their board assembly site for stencil design recommendations. Refer to IPC-7525 for other stencil recommendations.
  - E. Customers should contact their board fabrication site for solder mask tolerances between and around signal pads.

## 重要声明和免责声明

TI“按原样”提供技术和可靠性数据（包括数据表）、设计资源（包括参考设计）、应用或其他设计建议、网络工具、安全信息和其他资源，不保证没有瑕疵且不做任何明示或暗示的担保，包括但不限于对适销性、某特定用途方面的适用性或不侵犯任何第三方知识产权的暗示担保。

这些资源可供使用 TI 产品进行设计的熟练开发人员使用。您将自行承担以下全部责任：(1) 针对您的应用选择合适的 TI 产品，(2) 设计、验证并测试您的应用，(3) 确保您的应用满足相应标准以及任何其他功能安全、信息安全、监管或其他要求。

这些资源如有变更，恕不另行通知。TI 授权您仅可将这些资源用于研发本资源所述的 TI 产品的应用。严禁对这些资源进行其他复制或展示。您无权使用任何其他 TI 知识产权或任何第三方知识产权。您应全额赔偿因在这些资源的使用中对 TI 及其代表造成的任何索赔、损害、成本、损失和债务，TI 对此概不负责。

TI 提供的产品受 [TI 的销售条款](#) 或 [ti.com](#) 上其他适用条款/TI 产品随附的其他适用条款的约束。TI 提供这些资源并不会扩展或以其他方式更改 TI 针对 TI 产品发布的适用的担保或担保免责声明。

TI 反对并拒绝您可能提出的任何其他或不同的条款。

邮寄地址：Texas Instruments, Post Office Box 655303, Dallas, Texas 75265

Copyright © 2023，德州仪器 (TI) 公司

## X-ON Electronics

Largest Supplier of Electrical and Electronic Components

*Click to view similar products for [Operational Amplifiers - Op Amps](#) category:*

*Click to view products by [Texas Instruments](#) manufacturer:*

Other Similar products are found below :

[430227FB](#) [LT1678IS8](#) [NCV33202DMR2G](#) [NJM324E](#) [M38510/13101BPA](#) [NTE925](#) [AZV358MTR-G1](#) [AP4310AUMTR-AG1](#)  
[AZV358MMTR-G1](#) [SCY33178DR2G](#) [NCV20034DR2G](#) [NTE778S](#) [NTE871](#) [NTE937](#) [NJU7057RB1-TE2](#) [SCY6358ADR2G](#)  
[NJM2904CRB1-TE1](#) [UPC4570G2-E1-A](#) [UPC4741G2-E1-A](#) [NJM8532RB1-TE1](#) [EL2250CS](#) [EL5100IS](#) [EL5104IS](#) [EL5127CY](#) [EL5127CZY](#)  
[EL5133IW](#) [EL5152IS](#) [EL5156IS](#) [EL5162IS](#) [EL5202IY](#) [EL5203IY](#) [EL5204IY](#) [EL5210CS](#) [EL5210CZY](#) [EL5211IYE](#) [EL5220CY](#)  
[EL5223CLZ](#) [EL5223CR](#) [EL5224ILZ](#) [EL5227CLZ](#) [EL5227CRZ](#) [EL5244CS](#) [EL5246CS](#) [EL5246CSZ](#) [EL5250IY](#) [EL5251IS](#) [EL5257IS](#)  
[EL5260IY](#) [EL5261IS](#) [EL5300IU](#)