

# OPAx863 Low-Power, 110-MHz, Rail-to-Rail Input/Output Voltage-Feedback Op Amps

## 1 Features

- Wide-bandwidth
  - Unity-gain bandwidth: 110-MHz ( $A_V=1\text{ V/V}$ )
  - Gain-bandwidth product: 50-MHz
- Low power
  - Quiescent current: 700- $\mu\text{A}/\text{ch}$  (typical)
  - Power down mode: 1.5- $\mu\text{A}$  (maximum,  $V_S=3\text{ V}$ )
  - Supply voltage: 2.7-V to 12.6-V
- Input voltage noise: 5.9-nV/ $\sqrt{\text{Hz}}$
- Slew rate: 105-V/ $\mu\text{s}$
- Rail-to-rail input and output
- $\text{HD}_2/\text{HD}_3$ : -129 dBc/-138 dBc at 20 kHz (2- $V_{PP}$ )
- Operating temperature range: -40°C to +125°C
- Additional features:
  - Overload power limit
  - Output short-circuit protection
- High-precision version: [OPAx863A](#)

## 2 Applications

- [Low-power SAR and  \$\Delta\Sigma\$  ADC driver](#)
- [ADC reference buffer](#)
- [Low-side current sensing](#)
- [Photodiode TIA interface](#)
- [Inductive sensing](#)
- [Ultrasonic flow meter](#)
- [Multifunction printer](#)
- [MDAC output buffer](#)
- [Gain and active filter stages](#)

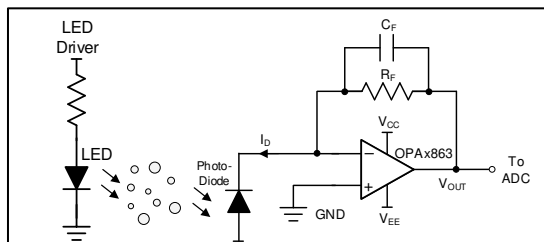

Transimpedance Amplifier Circuit

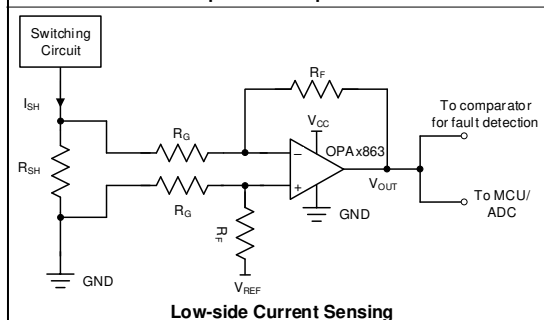

Low-side Current Sensing

### Application Circuits Using OPAx863

## 3 Description

The OPAx863 devices are low-power, unity-gain stable, rail-to-rail input and output, voltage-feedback operational amplifiers designed to operate over a power-supply range of 2.7 V to 12.6 V. Consuming only 700  $\mu\text{A}$  per channel, the OPAx863 offers a gain-bandwidth product of 50 MHz, slew rate of 105 V/ $\mu\text{s}$  with a voltage noise density of 5.9 nV/ $\sqrt{\text{Hz}}$ .

The rail-to-rail input stage with 2.7-V supply operation is useful in portable, battery-powered applications. The rail-to-rail input stage is well-matched for gain-bandwidth product and noise across the full input common-mode voltage range, enabling excellent performance with wide-input dynamic range. The OPAx863 feature a power-down (PD) mode with a PD quiescent current ( $I_Q$ ) of 1.5- $\mu\text{A}$  (maximum) and a turn-on or turn-off time within 6.5- $\mu\text{s}$  using a 3-V supply.

The OPAx863 includes overload power limiting to limit the increase in  $I_Q$  with saturated outputs, thereby preventing excessive power dissipation in power-conscious, battery-operated systems. The output stage is short-circuit protected, making these devices conducive to ruggedized environments.

### Device Information<sup>(1)(2)</sup>

PART NUMBER	CHANNEL COUNT	PACKAGE
OPA863	Single	DBV (SOT-23, 5)
		DBV (SOT-23, 6)
OPA2863	Dual	DGK (VSSOP, 8)
		RUN (WQFN, 10)
		D (SOIC, 8)
OPA4863	Quad	PW (TSSOP, 14)

- For all available packages, see the orderable addendum at the end of the data sheet.
- For related products, see [Device Comparison](#)

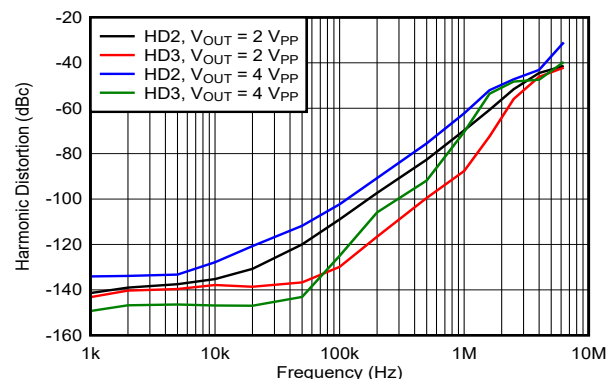

Distortion Performance in  $G = 1\text{ V/V}$



## Table of Contents

<b>1 Features</b> .....	1	8.1 Overview.....	21
<b>2 Applications</b> .....	1	8.2 Functional Block Diagram.....	21
<b>3 Description</b> .....	1	8.3 Feature Description.....	22
<b>4 Revision History</b> .....	2	8.4 Device Functional Modes.....	23
<b>5 Device Comparison Table</b> .....	3	<b>9 Application and Implementation</b> .....	24
<b>6 Pin Configuration and Functions</b> .....	3	9.1 Application Information.....	24
<b>7 Specifications</b> .....	6	9.2 Typical Applications.....	24
7.1 Absolute Maximum Ratings.....	6	9.3 Power Supply Recommendations.....	28
7.2 ESD Ratings.....	6	9.4 Layout.....	28
7.3 Recommended Operating Conditions.....	6	<b>10 Device and Documentation Support</b> .....	30
7.4 Thermal Information: OPA863.....	7	10.1 Documentation Support.....	30
7.5 Thermal Information: OPA2863.....	7	10.2 Receiving Notification of Documentation Updates.....	30
7.6 Thermal Information: OPA4863.....	7	10.3 Support Resources.....	30
7.7 Electrical Characteristics: $V_S = 10\text{ V}$ .....	8	10.4 Trademarks.....	30
7.8 Electrical Characteristics: $V_S = 3\text{ V}$ .....	10	10.5 Electrostatic Discharge Caution.....	30
7.9 Typical Characteristics: $V_S = 10\text{ V}$ .....	12	10.6 Glossary.....	30
7.10 Typical Characteristics: $V_S = 3\text{ V}$ .....	17	<b>11 Mechanical, Packaging, and Orderable Information</b> .....	30
7.11 Typical Characteristics: $V_S = 3\text{ V to }10\text{ V}$ .....	19		
<b>8 Detailed Description</b> .....	21		

## 4 Revision History

NOTE: Page numbers for previous revisions may differ from page numbers in the current version.

<b>Changes from Revision I (December 2022) to Revision J (June 2023)</b>	<b>Page</b>
• Changed the status of OPA4863 PW package, 14-pin TSSOP from: <i>preview</i> to: <i>production</i> and added associated content.....	1
<b>Changes from Revision H (August 2022) to Revision I (December 2022)</b>	<b>Page</b>
• Changed the status of the DBV package, 5-pin SOT23 from: <i>preview</i> to: <i>production</i> .....	1
<b>Changes from Revision G (July 2022) to Revision H (August 2022)</b>	<b>Page</b>
• Changed the status of the RUN Package, from: <i>preview</i> to: <i>production</i> .....	3
<b>Changes from Revision F (April 2022) to Revision G (July 2022)</b>	<b>Page</b>
• Added OPAx863A information to the <i>Features</i> section.....	1
• Added the DBV package, 5-pin SOT23 to the data sheet.....	1
• Changed the status of the D Package, from: <i>preview</i> to: <i>production</i> .....	3
• Updated the <i>Output Voltage vs Load Current</i> and <i>Output Voltage vs Load Current</i> figures to show typical device performance.....	12
<b>Changes from Revision E (November 2021) to Revision F (April 2022)</b>	<b>Page</b>
• Added the D package, 8-pin SOIC and RUN package, 10-pin WQFN to the data sheet.....	1

## 5 Device Comparison Table

DEVICE	$\pm V_S$ (V)	$I_Q$ / CHANNEL (mA)	GBWP (MHz)	SLEW RATE (V/ $\mu$ s)	VOLTAGE NOISE (nV/ $\sqrt{\text{Hz}}$ )	AMPLIFIER DESCRIPTION
OPA2863	$\pm 6.3$	0.70	50	105	5.9	Unity-gain stable RRIO Bipolar Amplifier
LMH6643	$\pm 6.4$	2.7	65	130	17	Unity-gain stable NRI/RRIO Bipolar Amplifier
OPAx810	$\pm 13.5$	3.6	70	200	6.3	Unity-gain stable RRIO FET-Input Amplifier
OPAx837	$\pm 2.7$	0.6	50	105	4.7	Unity-gain stable NRI/RRIO Bipolar Amplifier
OPAx607	$\pm 2.75$	0.9	50	24	3.8	Decompensated Gain of 6 V/V stable CMOS Amplifier

## 6 Pin Configuration and Functions

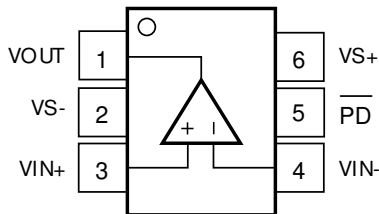

**Figure 6-1. OPA863 DBV Package, 6-Pin SOT-23 (Top View)**

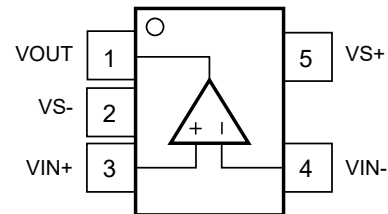
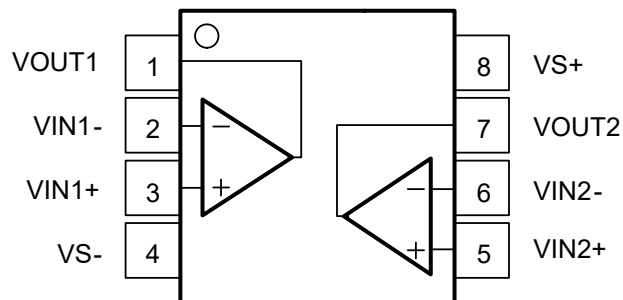

**Figure 6-2. OPA863 DBV Package, 5-Pin SOT-23 (Top View)**

**Table 6-1. Pin Functions: OPA863**

NAME	PIN		TYPE <sup>(1)</sup>	DESCRIPTION
	NO.			
	DBV (SOT-23, 5)	DBV (SOT-23, 6)		
PD	—	5	I	Power down. Low = disabled, high = normal operation (pin must be driven).
VIN+	3	3	I	Noninverting input pin
VIN-	4	4	I	Inverting input pin
VOUT	1	1	O	Output pin
VS-	2	2	P	Negative power-supply pin
VS+	5	6	P	Positive power-supply pin

(1) I = input, O = output, and P = power.



**Figure 6-3. OPA2863 D Package, 8-Pin SOIC and DGK Package, 8-Pin VSSOP, (Top View)**

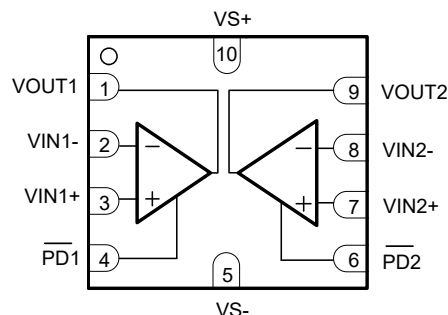
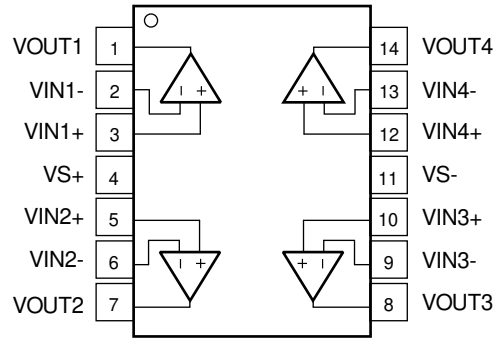

**Figure 6-4. OPA2863 RUN Package, 10-Pin WQFN (Top View)**

**Table 6-2. Pin Functions: OPA2863**

NAME	PIN NO.		TYPE <sup>(1)</sup>	DESCRIPTION
	D (SOIC), DGK (VSSOP)	RUN (WQFN)		
PD1	—	4	I	Amplifier 1 power down. Low = disabled, high = normal operation (pin must be driven).
PD2	—	6	I	Amplifier 2 power down. Low = disabled, high = normal operation (pin must be driven).
VIN1-	2	2	I	Amplifier 1 inverting input pin
VIN1+	3	3	I	Amplifier 1 noninverting input pin
VIN2-	6	8	I	Amplifier 2 inverting input pin
VIN2+	5	7	I	Amplifier 2 noninverting input pin
VOUT1	1	1	O	Amplifier 1 output pin
VOUT2	7	9	O	Amplifier 2 output pin
VS-	4	5	P	Negative power-supply pin
VS+	8	10	P	Positive power-supply pin

(1) I = input, O = output, and P = power.



**Figure 6-5. OPA4863 PW Package,  
14-Pin TSSOP  
(Top View)**

**Table 6-3. Pin Functions: OPA4863**

PIN		TYPE <sup>(1)</sup>	DESCRIPTION
NAME	NO.		
VIN1-	2	I	Amplifier 1 inverting input pin
VIN1+	3	I	Amplifier 1 noninverting input pin
VIN2-	6	I	Amplifier 2 inverting input pin
VIN2+	5	I	Amplifier 2 noninverting input pin
VIN3-	9	I	Amplifier 3 inverting input pin
VIN3+	10	I	Amplifier 3 noninverting input pin
VIN4-	13	I	Amplifier 4 inverting input pin
VIN4+	12	I	Amplifier 4 noninverting input pin
VOUT1	1	O	Amplifier 1 output pin
VOUT2	7	O	Amplifier 2 output pin
VOUT3	8	O	Amplifier 3 output pin
VOUT4	14	O	Amplifier 4 output pin
VS-	11	P	Negative power-supply pin
VS+	4	P	Positive power-supply pin

(1) I = input, O = output, and P = power.

## 7 Specifications

### 7.1 Absolute Maximum Ratings

over operating free-air temperature range (unless otherwise noted)<sup>(1)</sup>

		MIN	MAX	UNIT
$V_{S-}$ to $V_{S+}$	Supply voltage		13	V
	Supply turn-on/off maximum dV/dt, DBV-6 and D packages		0.1	V/ $\mu$ s
$V_I$	Input voltage	$V_{S-} - 0.5$	$V_{S+} + 0.5$	V
$V_{ID}$	Differential input voltage		$\pm 1$	V
$I_I$	Continuous input current <sup>(2)</sup>		$\pm 10$	mA
$I_O$	Continuous output current <sup>(3)</sup>		$\pm 30$	mA
	Continuous power dissipation	See <a href="#">Thermal Information</a>		
$T_J$	Maximum junction temperature		150	$^{\circ}$ C
$T_A$	Operating free-air temperature	-40	125	$^{\circ}$ C
$T_{stg}$	Storage temperature	-65	150	$^{\circ}$ C

- Operation outside the *Absolute Maximum Ratings* may cause permanent device damage. *Absolute Maximum Ratings* do not imply functional operation of the device at these or any other conditions beyond those listed under *Recommended Operating Conditions*. If used outside the *Recommended Operating Conditions* but within the *Absolute Maximum Ratings*, the device may not be fully functional, and this may affect device reliability, functionality, performance, and shorten the device lifetime.
- Continuous input current limit for both the ESD diodes to supply pins and amplifier differential input clamp diode. The differential input clamp diode limits the voltage across it to 1 V with this continuous input current flowing through it.
- Long-term continuous current for electromigration limits.

### 7.2 ESD Ratings

			VALUE	UNIT
$V_{(ESD)}$	Electrostatic discharge	Human body model (HBM), per ANSI/ESDA/JEDEC JS-001 <sup>(1)</sup>	$\pm 2000$	V
		Charged device model (CDM), per ANSI/ESDA/JEDEC JS-002 <sup>(2)</sup>	$\pm 1000$	

- JEDEC document JEP155 states that 500-V HBM allows safe manufacturing with a standard ESD control process.
- JEDEC document JEP157 states that 250-V CDM allows safe manufacturing with a standard ESD control process.

### 7.3 Recommended Operating Conditions

over operating free-air temperature range (unless otherwise noted)

		MIN	NOM	MAX	UNIT
$V_{S+} - V_{S-}$	Total supply voltage	2.7	10	12.6	V
$T_A$	Ambient temperature	-40	25	125	$^{\circ}$ C

### 7.4 Thermal Information: OPA863

THERMAL METRIC <sup>(1)</sup>		OPA863		UNIT
		DBV (SOT-23)		
		5 PINS	6 PINS	
$R_{\theta JA}$	Junction-to-ambient thermal resistance	168.3	161.8	°C/W
$R_{\theta JC(top)}$	Junction-to-case (top) thermal resistance	64.3	73.9	°C/W
$R_{\theta JB}$	Junction-to-board thermal resistance	40.6	42.6	°C/W
$\Psi_{JT}$	Junction-to-top characterization parameter	14.2	21.2	°C/W
$Y_{JB}$	Junction-to-board characterization parameter	40.3	42.5	°C/W

(1) For more information about traditional and new thermal metrics, see the [Semiconductor and IC Package Thermal Metrics](#) application report.

### 7.5 Thermal Information: OPA2863

THERMAL METRIC <sup>(1)</sup>		OPA2863			UNIT
		DGK (VSSOP)	D (SOIC)	RUN (WQFN)	
		8 PINS	8 PINS	10 PINS	
$R_{\theta JA}$	Junction-to-ambient thermal resistance	180.3	120.0	110.2	°C/W
$R_{\theta JC(top)}$	Junction-to-case (top) thermal resistance	67.5	63.3	66.8	°C/W
$R_{\theta JB}$	Junction-to-board thermal resistance	101.9	63.2	43.6	°C/W
$\Psi_{JT}$	Junction-to-top characterization parameter	9.8	17.2	2.9	°C/W
$Y_{JB}$	Junction-to-board characterization parameter	100.1	62.5	43.5	°C/W

(1) For more information about traditional and new thermal metrics, see the [Semiconductor and IC Package Thermal Metrics](#) application report.

### 7.6 Thermal Information: OPA4863

THERMAL METRIC <sup>(1)</sup>		OPA4863	UNIT
		PW (TSSOP)	
		14 PINS	
$R_{\theta JA}$	Junction-to-ambient thermal resistance	99.5	°C/W
$R_{\theta JC(top)}$	Junction-to-case (top) thermal resistance	27.6	°C/W
$R_{\theta JB}$	Junction-to-board thermal resistance	56.1	°C/W
$\Psi_{JT}$	Junction-to-top characterization parameter	4.4	°C/W
$Y_{JB}$	Junction-to-board characterization parameter	55.3	°C/W

(1) For more information about traditional and new thermal metrics, see the [Semiconductor and IC Package Thermal Metrics](#) application report.

## 7.7 Electrical Characteristics: $V_S = 10\text{ V}$

at  $V_{S+} = 5\text{ V}$ ,  $V_{S-} = -5\text{ V}$ ,  $G = 1\text{ V/V}$ ,  $R_F = 0\ \Omega$  for  $G = 1\text{ V/V}$ , otherwise  $R_F = 1\text{ k}\Omega$  for other gains,  $C_L = 1\text{ pF}$ ,  $R_L = 2\text{ k}\Omega$  referred to mid-supply, input and output common-mode is at mid-supply, and  $T_A \cong 25^\circ\text{C}$  (unless otherwise noted)

PARAMETER		TEST CONDITIONS	MIN	TYP	MAX	UNIT
<b>AC PERFORMANCE</b>						
SSBW	Small-signal bandwidth	$V_{OUT} = 20\text{ mV}_{PP}$ , $G = 1$ , $< 1\text{ dB}$ peaking		110		MHz
GBWP	Gain-bandwidth product			50		MHz
LSBW	Large-signal bandwidth	$V_{OUT} = 2\text{ V}_{PP}$		17		MHz
	Bandwidth for 0.1-dB flatness	$V_{OUT} = 20\text{ mV}_{PP}$		15		MHz
SR	Slew rate	$V_{OUT} = 2\text{-V}$ step, $G = -1$		105		V/ $\mu\text{s}$
	Rise, fall time	$V_{OUT} = 200\text{-mV}$ step		9		ns
	Settling time to 0.1%	$V_{OUT} = 2\text{-V}$ step		57		ns
	Settling time to 0.01%			70		
	Overshoot/undershoot	$V_{OUT} = 2\text{-V}$ step		1		%
	Overdrive recovery time	$G = -1$ , 0.5 V overdrive beyond supplies		70		ns
		$G = 1$ , 0.5 V overdrive beyond supplies		100		
HD2	Second-order harmonic distortion	$f = 20\text{ kHz}$ , $V_{OUT} = 2\text{ V}_{PP}$		-129		dBc
HD3	Third-order harmonic distortion			-138		
HD2	Second-order harmonic distortion	$f = 100\text{ kHz}$ , $V_{OUT} = 2\text{ V}_{PP}$		-107		dBc
HD3	Third-order harmonic distortion			-125		
$e_N$	Input voltage noise	Flatband, 1/f corner at 25 Hz		5.9		nV/ $\sqrt{\text{Hz}}$
$i_N$	Input current noise	Flatband, 1/f corner at 2 kHz		0.4		pA/ $\sqrt{\text{Hz}}$
	Closed-loop output impedance	$f = 1\text{ MHz}$		0.2		$\Omega$
	Channel-to-channel crosstalk	$f = 1\text{ MHz}$ , $V_{OUT} = 2\text{ V}_{PP}$ , OPA2863		-124		dBc
<b>DC PERFORMANCE</b>						
$A_{OL}$	Open-loop voltage gain	$V_{OUT} = \pm 2.5\text{ V}$	110	128		dB
$V_{OS}$	Input-referred offset voltage		-1.3	$\pm 0.4$	1.3	mV
	Input offset voltage drift	$T_A = -40^\circ\text{C}$ to $+125^\circ\text{C}$ , D, DBV-5, RUN and DGK packages	-3.5	$\pm 1$	3.5	$\mu\text{V}/^\circ\text{C}$
		$T_A = -40^\circ\text{C}$ to $+125^\circ\text{C}$ , PW package	-4	$\pm 1$	4	
		$T_A = 0^\circ\text{C}$ to $+85^\circ\text{C}$ , DBV-6 package	-4.4	$\pm 1$	4.4	
		$T_A = -40^\circ\text{C}$ to $+125^\circ\text{C}$ , DBV-6 package	-4.9	$\pm 1$	4.9	
	Input bias current	$T_A \cong 25^\circ\text{C}$		0.3	0.73	$\mu\text{A}$
		$T_A = -40^\circ\text{C}$ to $+85^\circ\text{C}$			1.2	
		$T_A = -40^\circ\text{C}$ to $+125^\circ\text{C}$			1.6	
	Input bias current drift	$T_A = -40^\circ\text{C}$ to $+125^\circ\text{C}$		$\pm 3$	7.6	nA/ $^\circ\text{C}$
	Input offset current		-30	$\pm 10$	30	nA
<b>INPUT</b>						
	Input common-mode voltage range		$V_{S-}-0.2$		$V_{S+}+0.2$	V
CMRR	Common-mode rejection ratio	$V_{CM} = V_{S-} - 0.2\text{ V}$ to $V_{S+} - 1.6\text{ V}$	100	120		dB
	Input impedance common-mode			650    0.8		M $\Omega$    pF
	Input impedance differential mode			200    0.5		k $\Omega$    pF
<b>OUTPUT</b>						
$V_{OL}$	Output voltage, low	$T_A \cong 25^\circ\text{C}$		$V_{S-}+0.14$	$V_{S-}+0.2$	V
		$T_A = -40^\circ\text{C}$ to $+125^\circ\text{C}$		$V_{S-}+0.15$	$V_{S-}+0.22$	
$V_{OH}$	Output voltage, high	$T_A \cong 25^\circ\text{C}$	$V_{S+}-0.2$	$V_{S+}-0.14$		V
		$T_A = -40^\circ\text{C}$ to $+125^\circ\text{C}$	$V_{S+}-0.2$	$V_{S+}-0.15$		



## 7.7 Electrical Characteristics: $V_S = 10\text{ V}$ (continued)

at  $V_{S+} = 5\text{ V}$ ,  $V_{S-} = -5\text{ V}$ ,  $G = 1\text{ V/V}$ ,  $R_F = 0\ \Omega$  for  $G = 1\text{ V/V}$ , otherwise  $R_F = 1\text{ k}\Omega$  for other gains,  $C_L = 1\text{ pF}$ ,  $R_L = 2\text{ k}\Omega$  referenced to mid-supply, input and output common-mode is at mid-supply, and  $T_A \cong 25^\circ\text{C}$  (unless otherwise noted)

PARAMETER		TEST CONDITIONS	MIN	TYP	MAX	UNIT
	Linear output drive (sourcing/sinking)	$V_{OUT} = \pm 2.5\text{ V}$ , $\Delta V_{OS} < 1\text{ mV}$ OPA863 and OPA2863 <sup>(1)</sup>	25	30		mA
	Short-circuit current			45		mA
<b>POWER SUPPLY</b>						
$I_Q$	Quiescent current per amplifier	$T_A \cong 25^\circ\text{C}$		700	970	$\mu\text{A}$
		$T_A = -40^\circ\text{C}$ to $+125^\circ\text{C}$			1280	
PSRR	Power-supply rejection ratio	$\Delta V_S = \pm 2\text{ V}$ <sup>(2)</sup>	100	120		dB
<b>POWER DOWN (Pin Must be Driven)</b>						
	Enable voltage threshold	Specified <i>on</i> above $V_{S+} - 0.5\text{ V}$			4.5	V
	Disable voltage threshold	Specified <i>off</i> below $V_{S+} - 1.5\text{ V}$	3.5			V
	Power-down quiescent current per channel	$\overline{PD} \leq V_{S+} - 1.5\text{ V}$		2	3.3	$\mu\text{A}$
	Power-down pin bias current			2	50	nA
	Turn-on time delay			6		$\mu\text{s}$
	Turn-off time delay			4.5		$\mu\text{s}$
<b>AUXILIARY INPUT STAGE</b>						
	Gain-bandwidth product			50		MHz
	Input voltage noise	Flatband, 1/f corner at 25 Hz		6		nV/ $\sqrt{\text{Hz}}$
	Input current noise	Flatband, 1/f corner at 100 Hz		0.4		pA/ $\sqrt{\text{Hz}}$
	Input-referred offset voltage		-1.3	$\pm 0.15$	1.3	mV
	Input bias current	$T_A \cong 25^\circ\text{C}$		0.2	0.6	$\mu\text{A}$
		$T_A = -40^\circ\text{C}$ to $+125^\circ\text{C}$		0.2	1.3	
	Common-mode rejection ratio	$V_{CM} = 4.1\text{ V}$ to $5.2\text{ V}$	100	120		dB
	Power supply rejection ratio	$\Delta V_S = \pm 0.6\text{ V}$	100	120		dB

- (1) Change in input offset voltage from no-load condition.
- (2) Change in supply voltage from the default test condition with only one of the positive or negative supplies changing corresponding to +PSRR and -PSRR.

## 7.8 Electrical Characteristics: $V_S = 3\text{ V}$

at  $V_{S+} = 3\text{ V}$ ,  $V_{S-} = 0\text{ V}$ ,  $G = 1$ ,  $R_F = 0\ \Omega$  for  $G = 1\text{ V/V}$ , otherwise  $R_F = 1\text{ k}\Omega$  for other gains,  $C_L = 1\text{ pF}$ ,  $R_L = 2\text{ k}\Omega$  connected to  $1\text{ V}$ , input and output  $V_{CM} = 1\text{ V}$ , and  $T_A \cong 25^\circ\text{C}$  (unless otherwise noted)

PARAMETER		TEST CONDITIONS	MIN	TYP	MAX	UNIT
<b>AC PERFORMANCE</b>						
SSBW	Small-signal bandwidth	$V_{OUT} = 20\text{ mV}_{PP}$ , $G = 1$		97		MHz
GBWP	Gain-bandwidth product			50		MHz
LSBW	Large-signal bandwidth	$V_{OUT} = 1\text{ V}_{PP}$		26		MHz
	Bandwidth for 0.1-dB flatness	$V_{OUT} = 20\text{ mV}_{PP}$		10		MHz
SR	Slew rate	$V_{OUT} = 1\text{-V step}$ , Gain = -1		105		V/ $\mu\text{s}$
	Rise, fall time	$V_{OUT} = 200\text{-mV step}$		10		ns
	Settling time to 0.1%	$V_{OUT} = 1\text{-V step}$		58		ns
	Settling time to 0.01%			90		
	Overshoot	$V_{OUT} = 1\text{-V step}$		2		%
	Undershoot			16		
	Overdrive recovery time	$G = -1$ , 0.5V overdrive beyond supplies		95		ns
		$G = 1$ , 0.5V overdrive beyond supplies		100		
HD2	Second-order harmonic distortion	$f = 20\text{ kHz}$ , $V_{OUT} = 1\text{ V}_{PP}$		-123		dBc
HD3	Third-order harmonic distortion			-132		
HD2	Second-order harmonic distortion	$f = 100\text{ kHz}$ , $V_{OUT} = 1\text{ V}_{PP}$		-109		dBc
HD3	Third-order harmonic distortion			-129		
$e_N$	Input voltage noise	Flatband, 1/f corner at 25 Hz		6		nV/ $\sqrt{\text{Hz}}$
$i_N$	Input current noise	Flatband, 1/f corner at 2 kHz		0.4		pA/ $\sqrt{\text{Hz}}$
	Closed-loop output impedance	$f = 1\text{ MHz}$		0.2		$\Omega$
	Channel-to-channel crosstalk	$f = 1\text{ MHz}$ , $V_{OUT} = 1\text{ V}_{PP}$ , OPA2863		-127		dBc
<b>DC PERFORMANCE</b>						
$A_{OL}$	Open-loop voltage gain	$V_{OUT} = 1\text{ V to }2\text{ V}$	104	123		dB
$V_{OS}$	Input-referred offset voltage		-1.3	$\pm 0.4$	1.3	mV
	Input offset voltage drift	$T_A = -40^\circ\text{C to }+125^\circ\text{C}$ , D, DBV-5, RUN, and DGK packages	-3.5	$\pm 1$	3.5	$\mu\text{V}/^\circ\text{C}$
		$T_A = -40^\circ\text{C to }+125^\circ\text{C}$ , PW package	-4	$\pm 1$	4	
		$T_A = 0^\circ\text{C to }+85^\circ\text{C}$ , DBV-6 package	-4.4	$\pm 1$	4.4	
		$T_A = -40^\circ\text{C to }+125^\circ\text{C}$ , DBV-6 package	-5	$\pm 1$	5	
	Input bias current	$T_A \cong 25^\circ\text{C}$		0.3	0.73	$\mu\text{A}$
		$T_A = -40^\circ\text{C to }+85^\circ\text{C}$			1.2	
		$T_A = -40^\circ\text{C to }+125^\circ\text{C}$			1.56	
	Input bias current drift	$T_A = -40^\circ\text{C to }+125^\circ\text{C}$		$\pm 3$	7.4	nA/ $^\circ\text{C}$
	Input offset current		-30	$\pm 10$	30	nA
<b>INPUT</b>						
	Input common-mode voltage range		$V_{S-}-0.2$	$V_{S+}+0.2$		V
CMRR	Common-mode rejection ratio	$V_{CM} = V_{S-} - 0.2\text{ V to }V_{S+} - 1.6\text{ V}$	94	115		dB
	Input impedance common-mode			360    0.9		M $\Omega$    pF
	Input impedance differential mode			200    0.5		k $\Omega$    pF

## 7.8 Electrical Characteristics: $V_S = 3\text{ V}$ (continued)

at  $V_{S+} = 3\text{ V}$ ,  $V_{S-} = 0\text{ V}$ ,  $G = 1$ ,  $R_F = 0\ \Omega$  for  $G = 1\text{ V/V}$ , otherwise  $R_F = 1\text{ k}\Omega$  for other gains,  $C_L = 1\text{ pF}$ ,  $R_L = 2\text{ k}\Omega$  connected to  $1\text{ V}$ , input and output  $V_{CM} = 1\text{ V}$ , and  $T_A \cong 25^\circ\text{C}$  (unless otherwise noted)

PARAMETER		TEST CONDITIONS	MIN	TYP	MAX	UNIT
<b>OUTPUT</b>						
$V_{OL}$	Output voltage, low	$T_A \cong 25^\circ\text{C}$		$V_{S-} + 0.13$	$V_{S-} + 0.15$	V
		$T_A = -40^\circ\text{C}$ to $+125^\circ\text{C}$		$V_{S-} + 0.13$	$V_{S-} + 0.16$	
$V_{OH}$	Output voltage, high	$T_A \cong 25^\circ\text{C}$	$V_{S+} - 0.15$	$V_{S+} - 0.13$		V
		$T_A = -40^\circ\text{C}$ to $+125^\circ\text{C}$	$V_{S+} - 0.15$	$V_{S+} - 0.13$		
	Linear output drive (sourcing/sinking)	$V_{OUT} = \pm 0.7\text{ V}$ , $\Delta V_{OS} < 1\text{ mV}$ OPA863 and OPA2863 <sup>(1)</sup>	23	33		mA
	Short-circuit current			45		mA
<b>POWER SUPPLY</b>						
$I_Q$	Quiescent current per amplifier	$T_A \cong 25^\circ\text{C}$		690	910	$\mu\text{A}$
		$T_A = -40^\circ\text{C}$ to $+125^\circ\text{C}$			1180	
PSRR	Power-supply rejection ratio	$\Delta V_S = \pm 1\text{ V}$ <sup>(2)</sup>	100	120		dB
<b>POWER DOWN (Pin Must be Driven)</b>						
	Enable voltage threshold	Specified on above $V_{S+} - 0.5\text{ V}$			2.5	V
	Disable voltage threshold	Specified off below $V_{S+} - 1.5\text{ V}$	1.5			V
	Power-down quiescent current per channel	$\overline{PD} \leq V_{S+} - 1.5\text{ V}$		0.8	1.5	$\mu\text{A}$
	Power-down pin bias current			1	50	nA
	Turn-on time delay			6.5		$\mu\text{s}$
	Turn-off time delay			5		$\mu\text{s}$
<b>AUXILIARY INPUT STAGE</b>						
	Gain-bandwidth product			50		MHz
	Input voltage noise	Flatband, 1/f corner at 25 Hz		6		$\text{nV}/\sqrt{\text{Hz}}$
	Input current noise	Flatband, 1/f corner at 100 Hz		0.4		$\text{pA}/\sqrt{\text{Hz}}$
	Input-referred offset voltage		-1.3	$\pm 0.15$	1.3	mV
	Input bias current	$T_A \cong 25^\circ\text{C}$		0.2	0.6	$\mu\text{A}$
		$T_A = -40^\circ\text{C}$ to $+125^\circ\text{C}$		0.4	1.2	
	Common-mode rejection ratio	$V_{CM} = 2.1\text{ V}$ to $3.2\text{ V}$	100	120		dB
	Power supply rejection ratio	$\Delta V_S = \pm 0.6\text{ V}$	100	115		dB

(1) Change in input offset voltage from no-load condition.

(2) Change in supply voltage from the default test condition with only one of the positive or negative supplies changing corresponding to +PSRR and -PSRR.

## 7.9 Typical Characteristics: $V_S = 10\text{ V}$

at  $V_{S+} = 5\text{ V}$ ,  $V_{S-} = -5\text{ V}$ ,  $R_F = 0\ \Omega$  for Gain = 1 V/V, otherwise  $R_F = 1\text{ k}\Omega$  for other gains,  $C_L = 1\text{ pF}$ ,  $R_L = 2\text{ k}\Omega$  referenced to mid-supply,  $G = 1\text{ V/V}$ , input and output referenced to mid-supply, and  $T_A \approx 25^\circ\text{C}$  (unless otherwise noted)

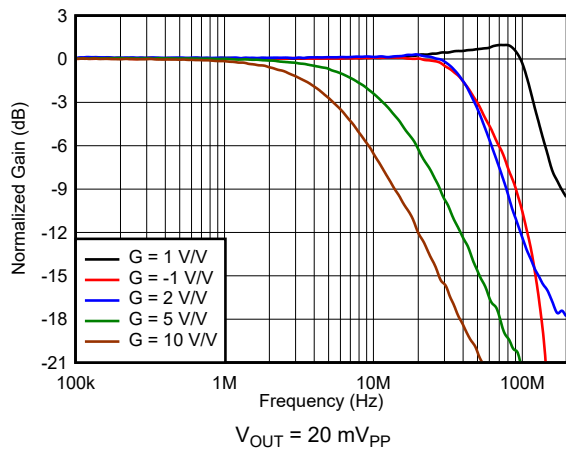

Figure 7-1. Small-Signal Frequency Response vs Gain

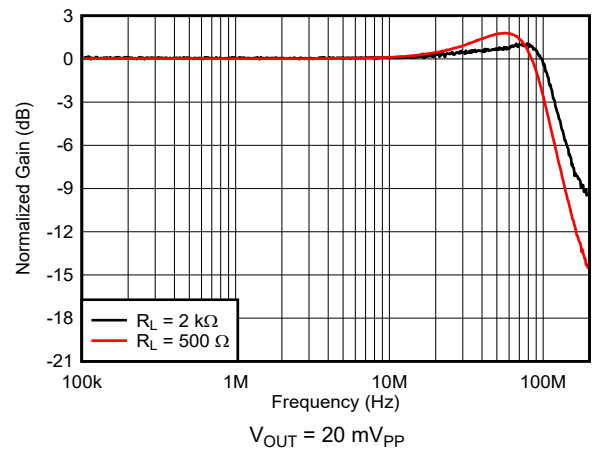

Figure 7-2. Small-Signal Frequency Response vs Output Load

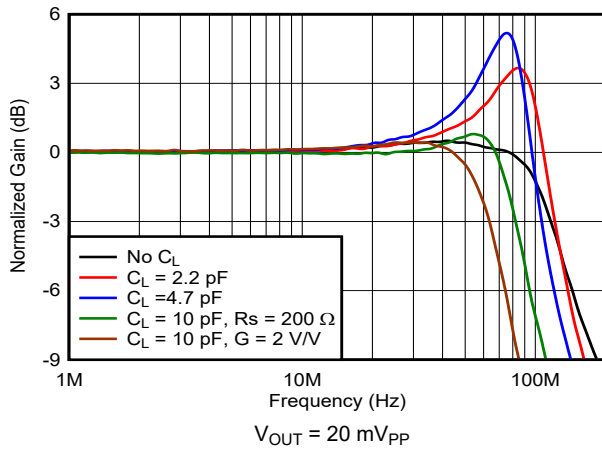

Figure 7-3. Frequency Response vs Load Capacitance

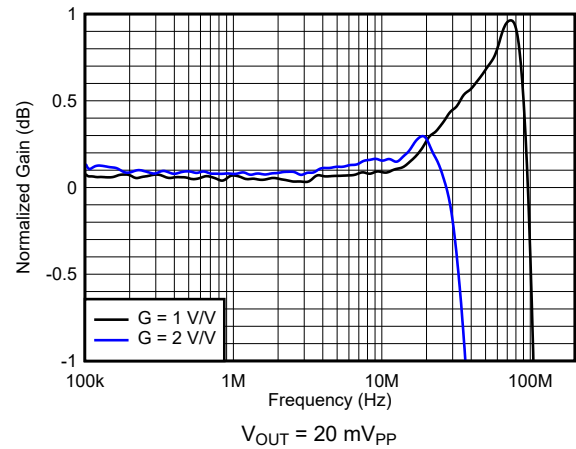

Figure 7-4. Small-Signal Response Flatness vs Gain

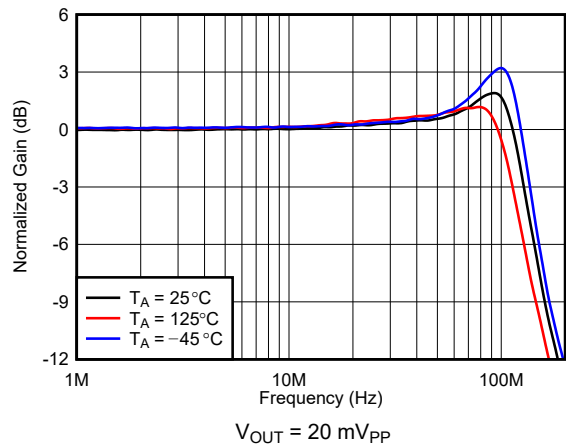

Figure 7-5. Frequency Response vs Ambient Temperature

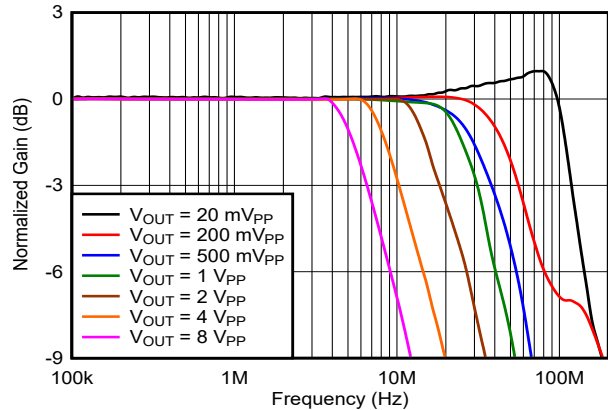
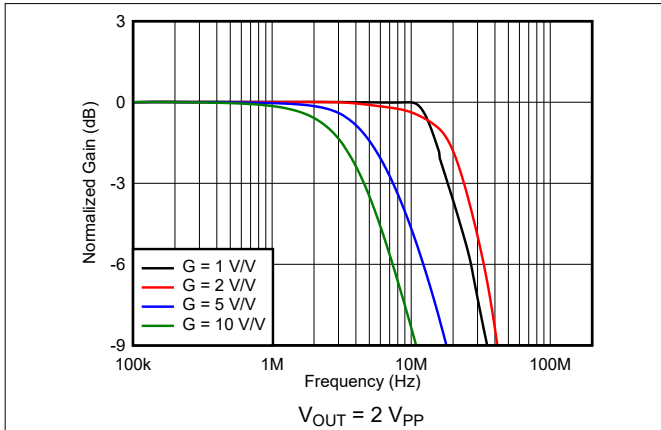

Figure 7-6. Frequency Response vs Output Voltage

### 7.9 Typical Characteristics: $V_S = 10\text{ V}$ (continued)

at  $V_{S+} = 5\text{ V}$ ,  $V_{S-} = -5\text{ V}$ ,  $R_F = 0\ \Omega$  for Gain = 1 V/V, otherwise  $R_F = 1\text{ k}\Omega$  for other gains,  $C_L = 1\text{ pF}$ ,  $R_L = 2\text{ k}\Omega$  referenced to mid-supply,  $G = 1\text{ V/V}$ , input and output referenced to mid-supply, and  $T_A \approx 25^\circ\text{C}$  (unless otherwise noted)



**Figure 7-7. Large-Signal Frequency Response vs Gain**

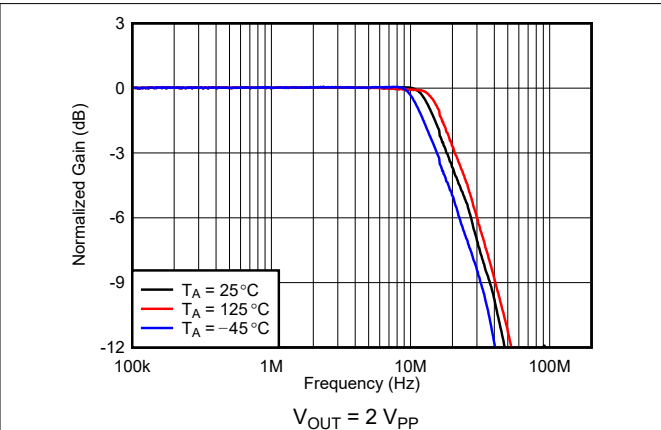

**Figure 7-8. Frequency Response vs Ambient Temperature**

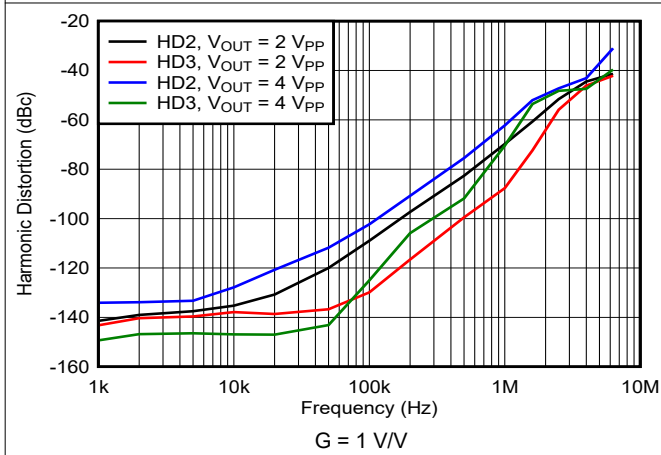

**Figure 7-9. Harmonic Distortion vs Frequency**

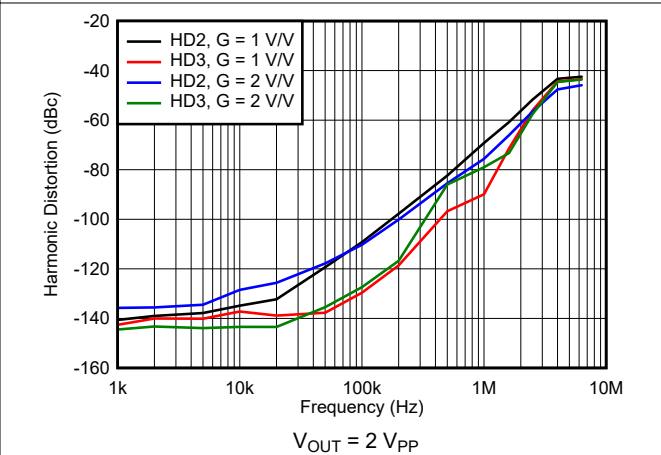

**Figure 7-10. Harmonic Distortion vs Gain**

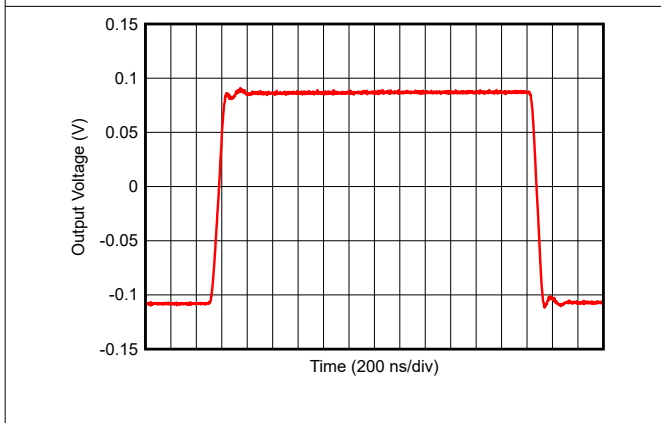

**Figure 7-11. Small-Signal Transient Response**

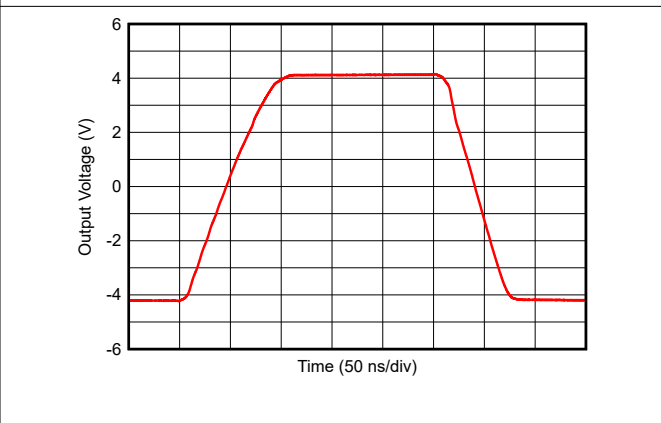

**Figure 7-12. Large-Signal Transient Response**

### 7.9 Typical Characteristics: $V_S = 10\text{ V}$ (continued)

at  $V_{S+} = 5\text{ V}$ ,  $V_{S-} = -5\text{ V}$ ,  $R_F = 0\ \Omega$  for Gain = 1 V/V, otherwise  $R_F = 1\text{ k}\Omega$  for other gains,  $C_L = 1\text{ pF}$ ,  $R_L = 2\text{ k}\Omega$  referenced to mid-supply,  $G = 1\text{ V/V}$ , input and output referenced to mid-supply, and  $T_A \approx 25^\circ\text{C}$  (unless otherwise noted)

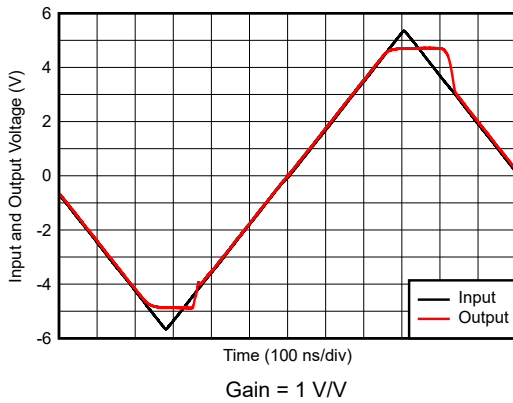

Figure 7-13. Input Overdrive Recovery

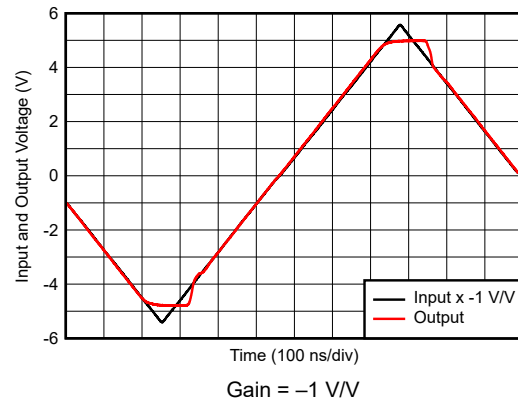

Figure 7-14. Output Overdrive Recovery

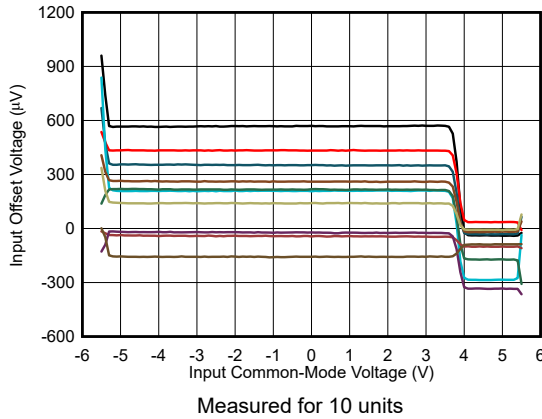

Figure 7-15. Input Offset Voltage vs Input Common-Mode Voltage

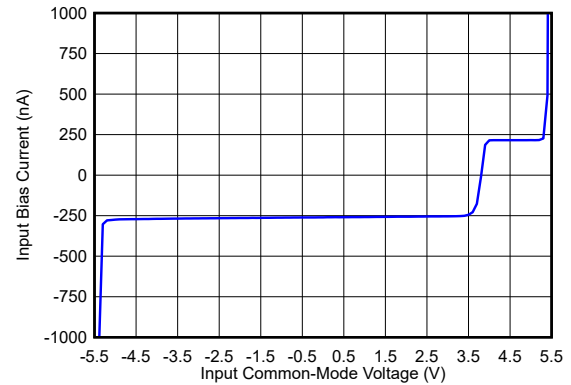

Figure 7-16. Input Bias Current vs Input Common-Mode Voltage

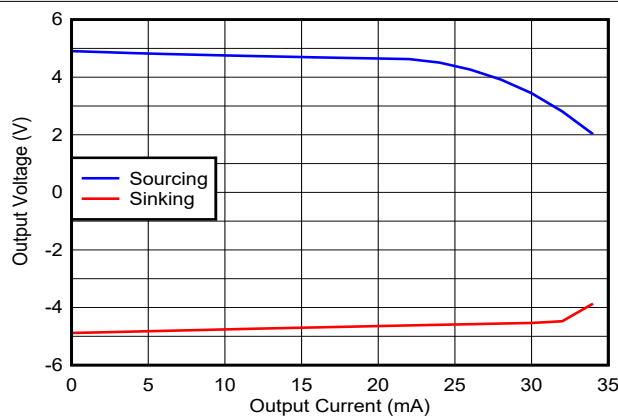
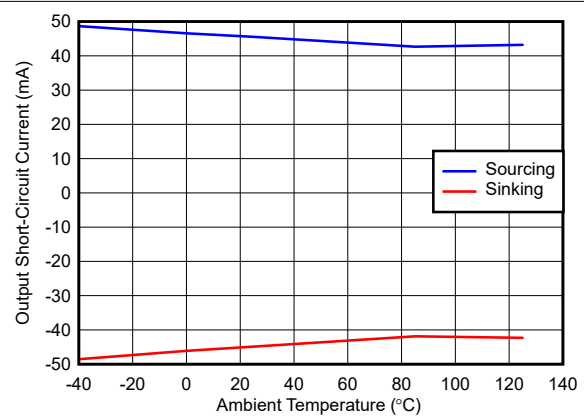

Figure 7-17. Output Voltage vs Load Current



Output saturated and then short-circuited to opposite supply  
Figure 7-18. Output Short-Circuit Current vs Ambient Temperature

### 7.9 Typical Characteristics: $V_S = 10\text{ V}$ (continued)

at  $V_{S+} = 5\text{ V}$ ,  $V_{S-} = -5\text{ V}$ ,  $R_F = 0\ \Omega$  for Gain = 1 V/V, otherwise  $R_F = 1\text{ k}\Omega$  for other gains,  $C_L = 1\text{ pF}$ ,  $R_L = 2\text{ k}\Omega$  referenced to mid-supply,  $G = 1\text{ V/V}$ , input and output referenced to mid-supply, and  $T_A \approx 25^\circ\text{C}$  (unless otherwise noted)

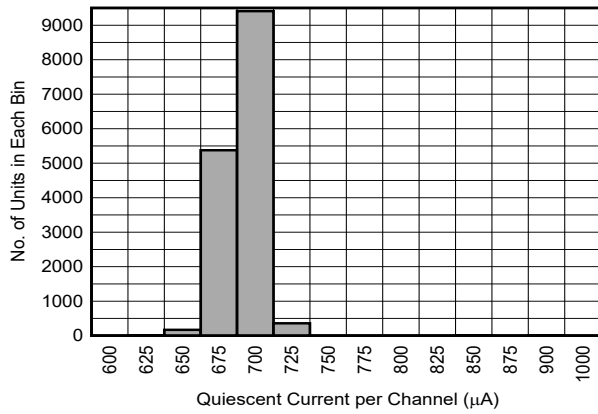

$\mu = 678\ \mu\text{A}$ ,  $\sigma = 13\ \mu\text{A}$

**Figure 7-19. Quiescent Current Distribution**

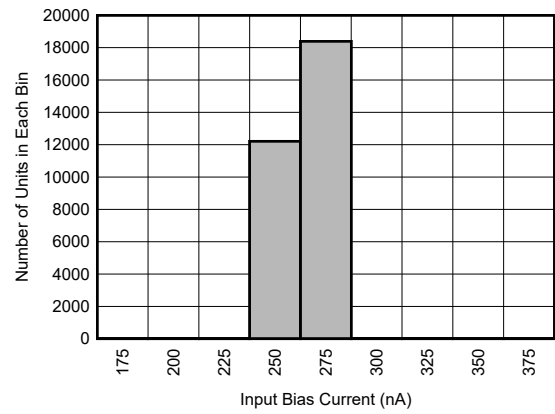

$\mu = 251\text{ nA}$ ,  $\sigma = 5.6\text{ nA}$

**Figure 7-20. Input Bias Current Distribution**

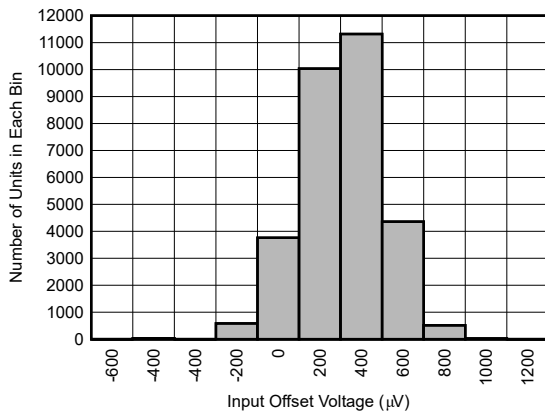

$\mu = 209\ \mu\text{V}$ ,  $\sigma = 193\ \mu\text{V}$

**Figure 7-21. Input Offset Voltage Distribution**

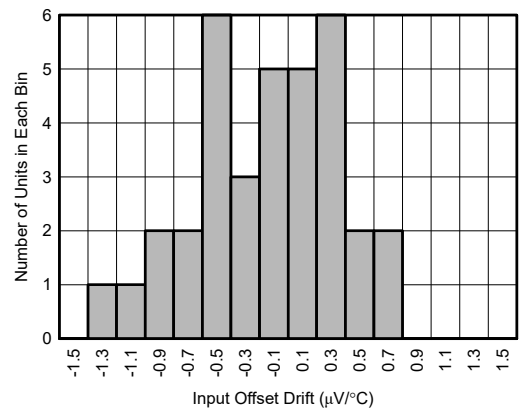

35 units,  $\mu = -0.26\ \mu\text{V}/^\circ\text{C}$ ,  $\sigma = 0.49\ \mu\text{V}/^\circ\text{C}$ , DGK package

**Figure 7-22. Input Offset Voltage Drift Distribution**

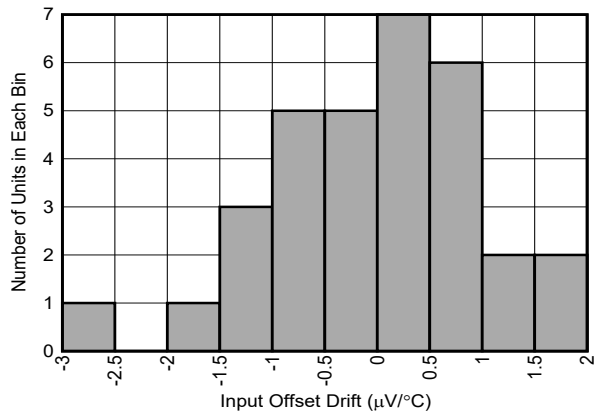

32 units,  $\mu = -0.02\ \mu\text{V}/^\circ\text{C}$ ,  $\sigma = 0.98\ \mu\text{V}/^\circ\text{C}$ , DBV-6 package

**Figure 7-23. Input Offset Voltage Drift Distribution**

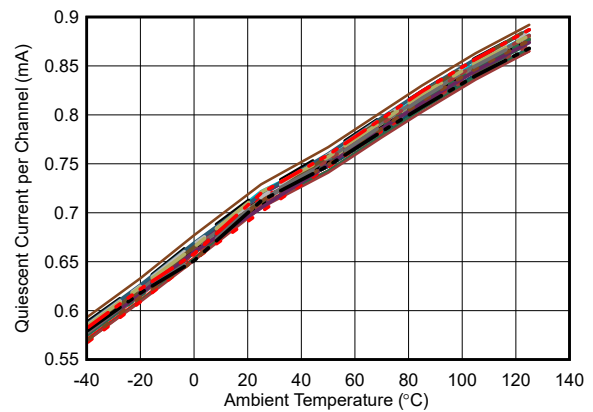

**Figure 7-24. Quiescent Current vs Ambient Temperature**

## 7.9 Typical Characteristics: $V_S = 10\text{ V}$ (continued)

at  $V_{S+} = 5\text{ V}$ ,  $V_{S-} = -5\text{ V}$ ,  $R_F = 0\ \Omega$  for Gain = 1 V/V, otherwise  $R_F = 1\text{ k}\Omega$  for other gains,  $C_L = 1\text{ pF}$ ,  $R_L = 2\text{ k}\Omega$  referenced to mid-supply,  $G = 1\text{ V/V}$ , input and output referenced to mid-supply, and  $T_A \cong 25^\circ\text{C}$  (unless otherwise noted)

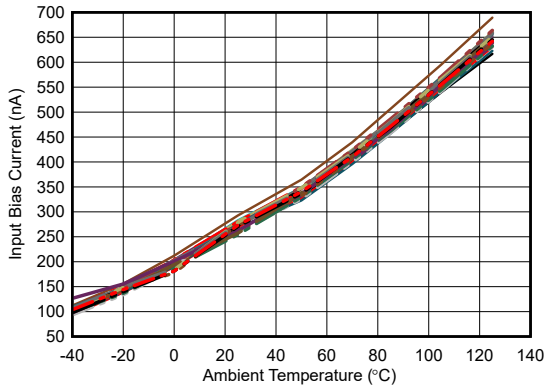

**Figure 7-25. Input Bias Current vs Ambient Temperature**

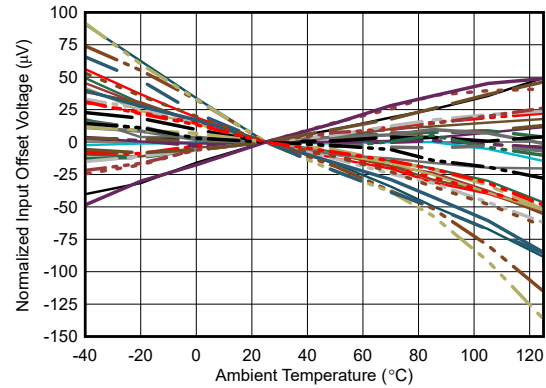

**Figure 7-26. Input Offset Voltage vs Ambient Temperature**

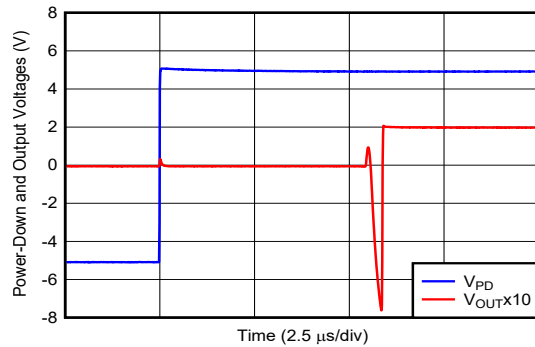

**Figure 7-27. Turn-On Time to DC Input**

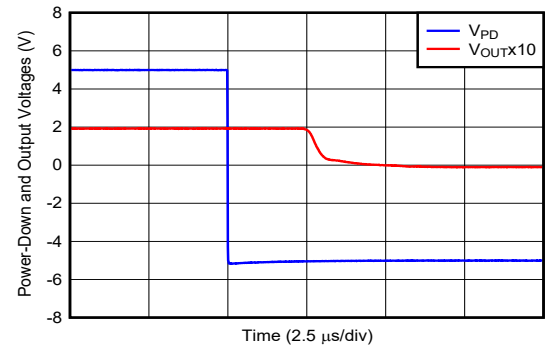

**Figure 7-28. Turn-Off Time to DC Input**

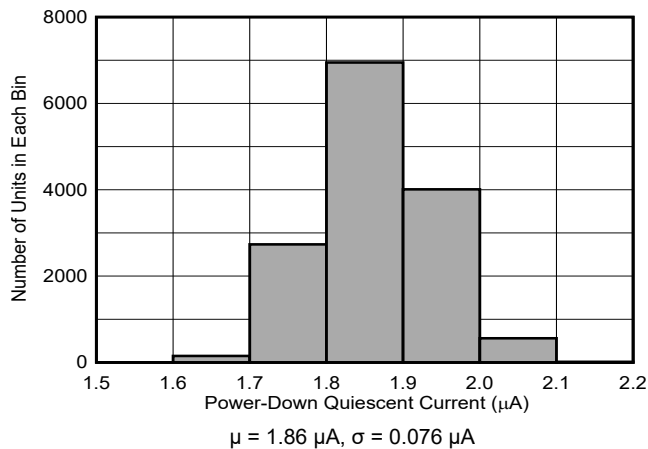

**Figure 7-29. Power-Down Quiescent Current Distribution**

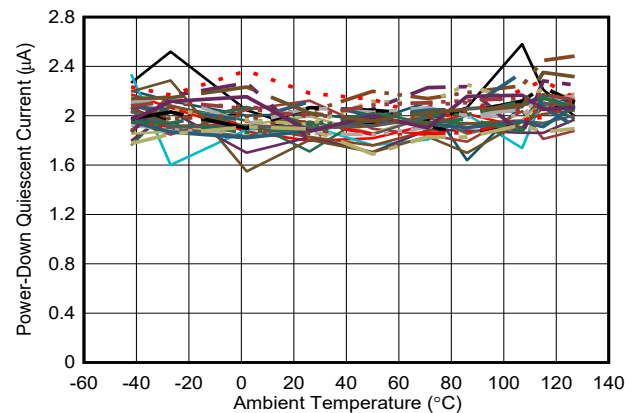
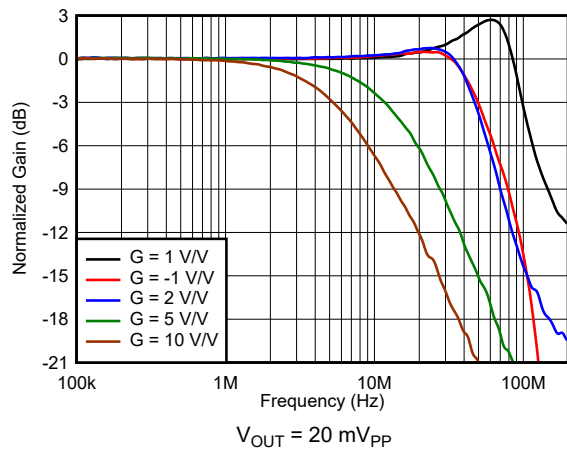

**Figure 7-30. Power-Down  $I_Q$  vs Ambient Temperature**



### 7.10 Typical Characteristics: $V_S = 3\text{ V}$

at  $V_{S+} = 3\text{ V}$ ,  $V_{S-} = 0\text{ V}$ ,  $R_F = 0\ \Omega$  for Gain = 1 V/V, otherwise  $R_F = 1\text{ k}\Omega$  for other gains,  $C_L = 1\text{ pF}$ ,  $R_L = 2\text{ k}\Omega$  connected to 1 V,  $G = 1\text{ V/V}$ , input and output  $V_{CM} = 1\text{ V}$ , and  $T_A \approx 25^\circ\text{C}$  (unless otherwise noted)



**Figure 7-31. Small-Signal Frequency Response vs Gain**

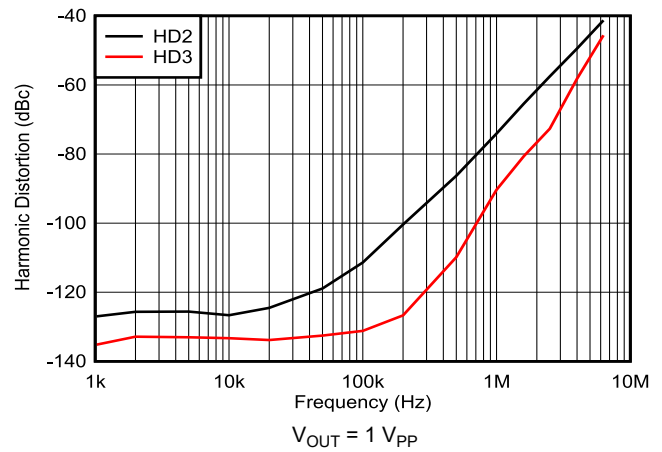

**Figure 7-32. Harmonic Distortion vs Frequency**

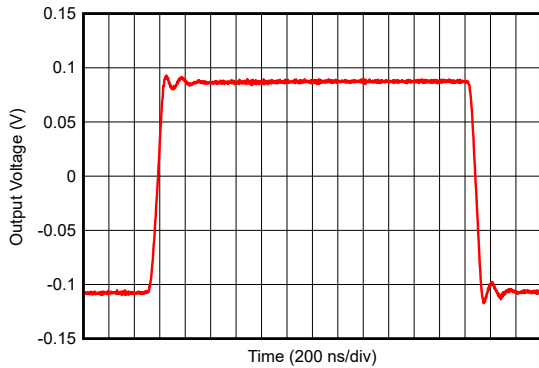

**Figure 7-33. Small-Signal Transient Response**

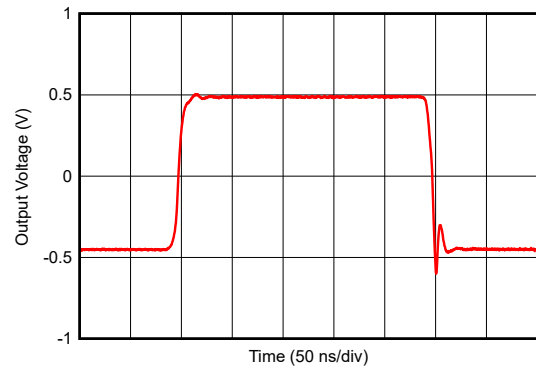

**Figure 7-34. Large-Signal Transient Response**

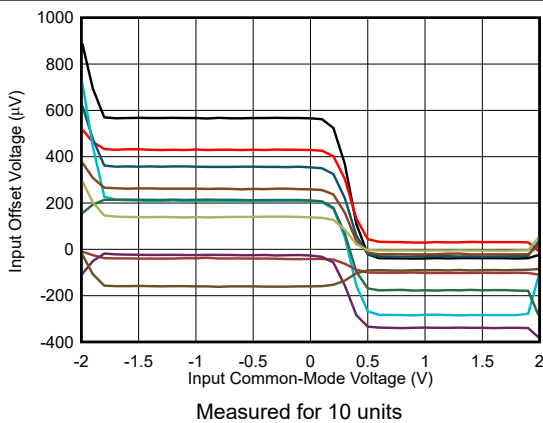

**Figure 7-35. Input Offset Voltage vs Input Common-Mode Voltage**  
Measured for 10 units

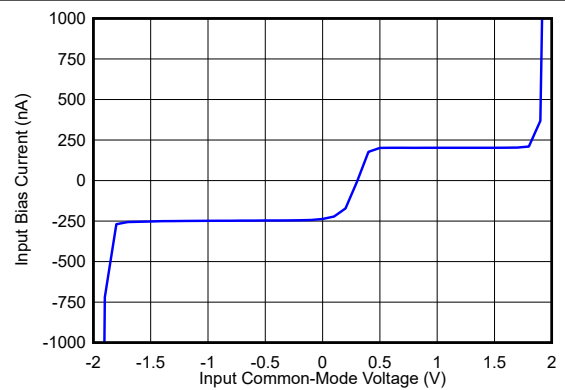

**Figure 7-36. Input Bias Current vs Input Common-Mode Voltage**

### 7.10 Typical Characteristics: $V_S = 3\text{ V}$ (continued)

at  $V_{S+} = 3\text{ V}$ ,  $V_{S-} = 0\text{ V}$ ,  $R_F = 0\ \Omega$  for Gain = 1 V/V, otherwise  $R_F = 1\text{ k}\Omega$  for other gains,  $C_L = 1\text{ pF}$ ,  $R_L = 2\text{ k}\Omega$  connected to 1 V,  $G = 1\text{ V/V}$ , input and output  $V_{CM} = 1\text{ V}$ , and  $T_A \cong 25^\circ\text{C}$  (unless otherwise noted)

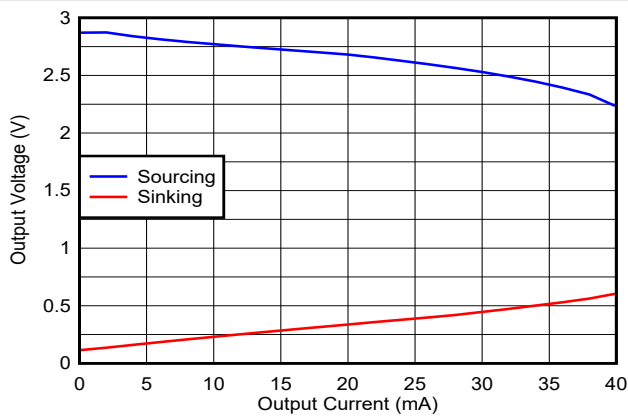
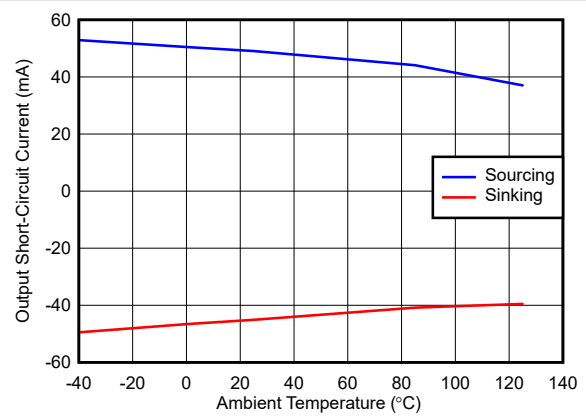

Figure 7-37. Output Voltage vs Load Current



Output saturated and then short-circuited to other supply  
Figure 7-38. Output Short-Circuit Current vs Ambient Temperature

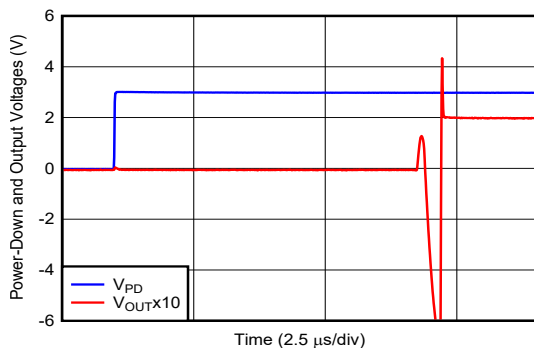

Figure 7-39. Turn-On Time to DC Input

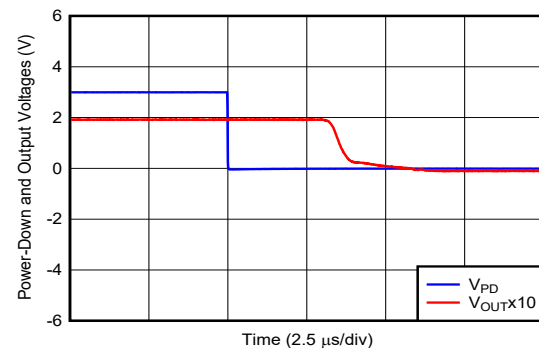

Figure 7-40. Turn-Off Time to DC Input

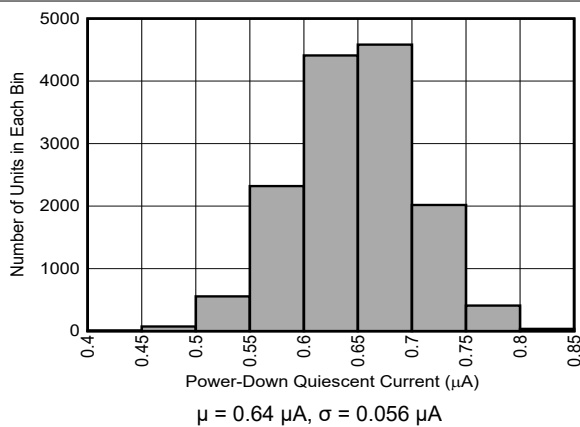

Figure 7-41. Power-Down Quiescent Current Distribution

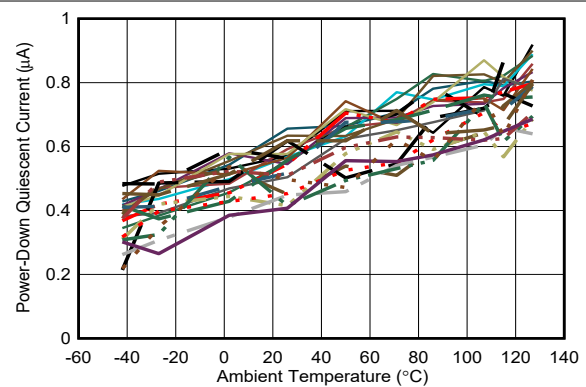
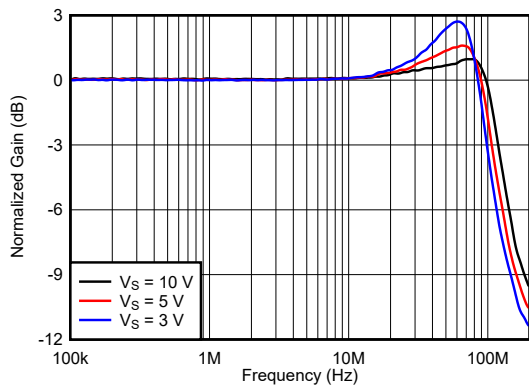

Figure 7-42. Power-Down  $I_Q$  vs Ambient Temperature

### 7.11 Typical Characteristics: $V_S = 3\text{ V to }10\text{ V}$

at  $V_{OUT} = 2\text{ V}_{PP}$ ,  $R_F = 0\ \Omega$  for Gain = 1 V/V, otherwise  $R_F = 1\text{ k}\Omega$  for other gains,  $C_L = 1\text{ pF}$ ,  $R_L = 2\text{ k}\Omega$  referenced to mid-supply,  $G = 1\text{ V/V}$ , input and output referenced to mid-supply, and  $T_A \cong 25^\circ\text{C}$  (unless otherwise noted)



$V_{OUT} = 20\text{ mV}_{PP}$

Figure 7-43. Frequency Response vs Supply Voltage

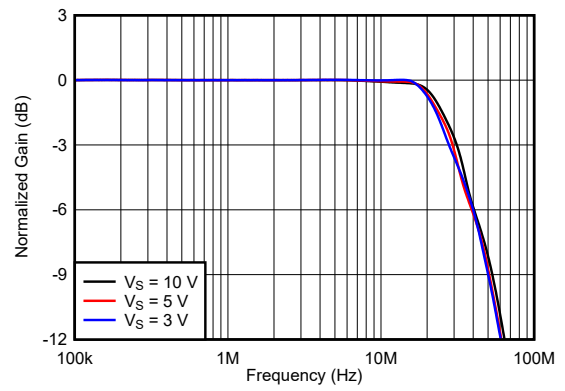

$V_{OUT} = 1\text{ V}_{PP}$

Figure 7-44. Frequency Response vs Supply Voltage

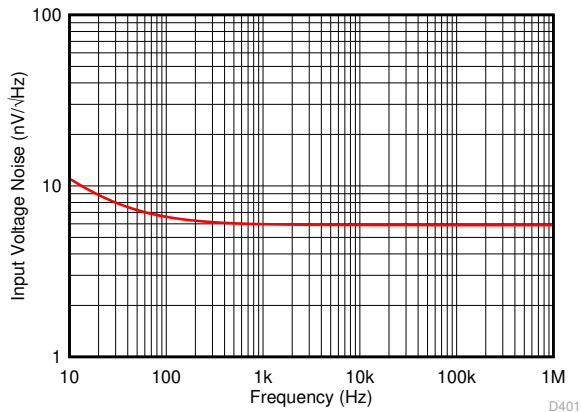

Figure 7-45. Input Voltage Noise Density vs Frequency

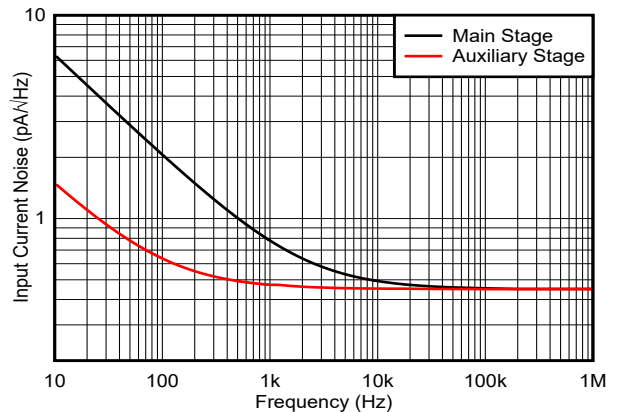

Figure 7-46. Input Current Noise Density vs Frequency

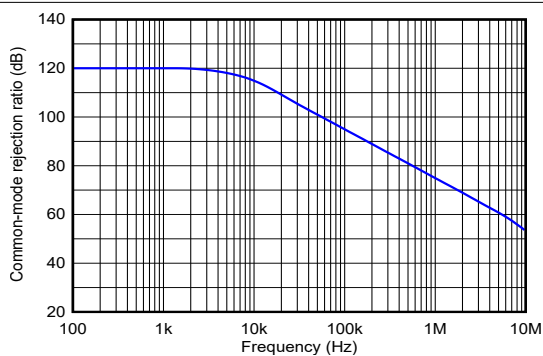

Figure 7-47. Common-Mode Rejection Ratio vs Frequency

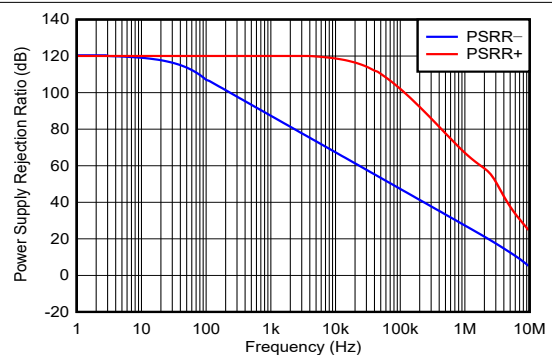

Figure 7-48. Power Supply Rejection Ratio vs Frequency

### 7.11 Typical Characteristics: $V_S = 3\text{ V to }10\text{ V}$ (continued)

at  $V_{OUT} = 2\text{ V}_{PP}$ ,  $R_F = 0\ \Omega$  for Gain = 1 V/V, otherwise  $R_F = 1\text{ k}\Omega$  for other gains,  $C_L = 1\text{ pF}$ ,  $R_L = 2\text{ k}\Omega$  referenced to mid-supply,  $G = 1\text{ V/V}$ , input and output referenced to mid-supply, and  $T_A \cong 25^\circ\text{C}$  (unless otherwise noted)

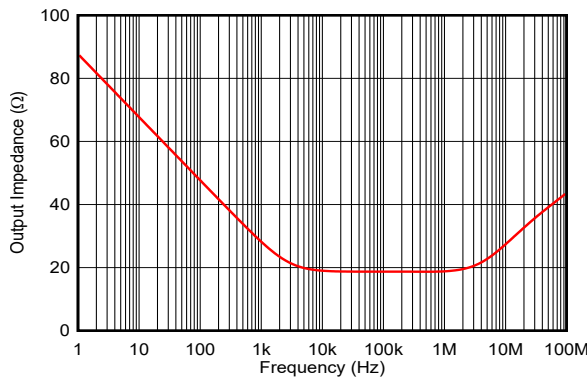

Figure 7-49. Open-Loop Output Impedance vs Frequency

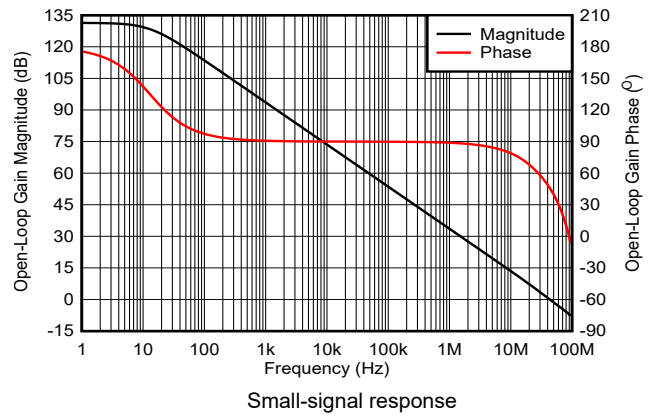

Figure 7-50. Open-Loop Gain and Phase vs Frequency

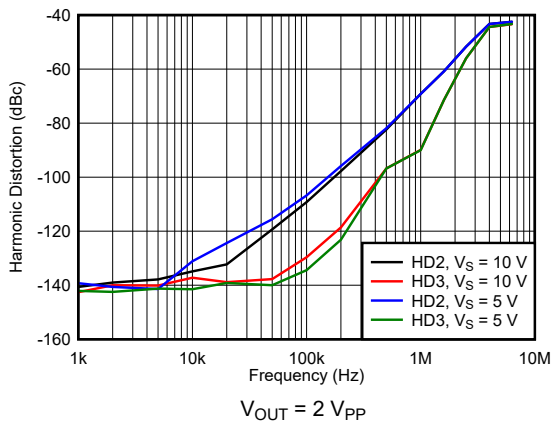

Figure 7-51. Harmonic Distortion vs Supply Voltage

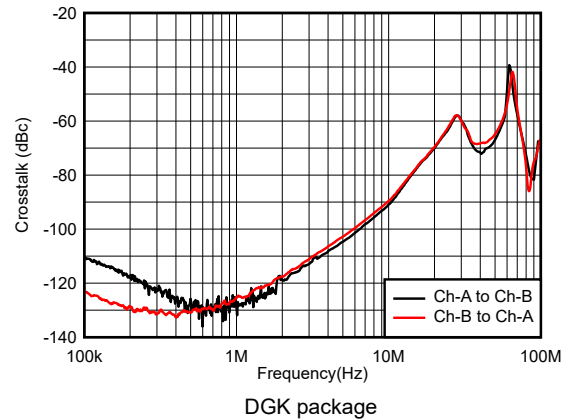

Figure 7-52. Crosstalk vs Frequency

## 8 Detailed Description

### 8.1 Overview

The OPAx863 devices are low-power, 50-MHz, rail-to-rail input and output (RRIO), bipolar, voltage-feedback operational amplifiers with a voltage noise density of 5.9 nV/√Hz and 1/f noise corner at 25 Hz. The OPAx863 work with a wide-supply voltage range of 2.7 V to 12.6 V, and consume only 700 μA quiescent current. The OPAx863 operate with a 2.7 V supply, are RRIO capable, consume low-power, and offer a power-down mode, which makes them great amplifiers for 3.3-V or lower-voltage applications that require excellent ac performance. The main and auxiliary input stages of the amplifier are matched for gain bandwidth product (GBW), noise, and offset voltage and designed for applications that require wide dynamic input range and good SNR.

The device includes an overload power limit feature which limits the increase in quiescent current with overdriven and saturated outputs to either of the supply rails. For more details of this overload power limit feature, see [Section 8.3.2.1](#). The amplifier's output is protected against short-circuit fault conditions.

The OPAx863 feature a power-down mode (PD) with a PD quiescent current of 1.5 μA (maximum) with a 3-V supply, with turn-on and turn-off time within less than 6.5 μs.

### 8.2 Functional Block Diagram

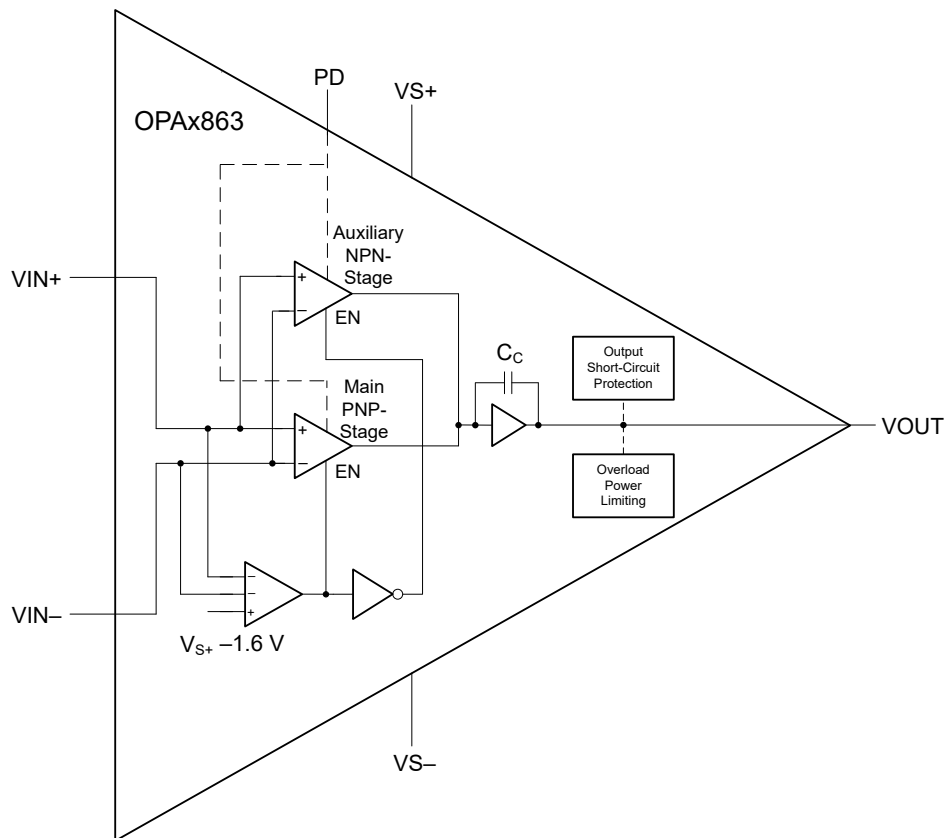

## 8.3 Feature Description

### 8.3.1 Input Stage

The OPAx863 include a rail-to-rail input stage. The main stage differential pair using PNP bipolar transistors operates for common-mode input voltages from  $V_{S-} - 0.2$  V to  $V_{S+} - 1.6$  V. The amplifier inputs transition into the auxiliary stage using NPN transistors for common-mode input voltages from  $V_{S+} - 1.6$  V till  $V_{S+} + 0.2$  V. The PNP and NPN input stages offer a gain-bandwidth product of 50 MHz and a voltage noise density of 6.3 nV/ $\sqrt{\text{Hz}}$ . The offset voltage for the two input stages is matched to lie within the device specifications. The auxiliary NPN input stage does not use the slew-boost circuit during large-signal transient response. The input bias current for the PNP and NPN input stages is opposite in polarity, which adds an additional offset based on the values of the gain-setting and feedback resistors. A common-mode input voltage transition between these input stages causes a crossover distortion that must be considered in high-frequency applications requiring excellent linearity. Limit the common-mode input voltage to  $V_{S+} - 1.6$  V (maximum) for main-stage operation across process and ambient temperature.

The OPAx863 are bipolar amplifiers; therefore, the two inputs are protected with antiparallel back-to-back diodes between the inputs, which limits the maximum input differential voltage to 1 V. The amplifier is slew limited, and the two inputs are pulled apart up to 1 V when the antiparallel diodes begin to conduct in very fast input or output transient conditions. Make sure to use gain-setting and feedback resistors large enough to limit the current through these diodes in such conditions.

### 8.3.2 Output Stage

The OPAx863 feature a rail-to-rail output stage with possible signal swing from  $V_{S-} + 0.2$  V to  $V_{S+} - 0.2$  V. Violating the output headroom of either supply causes output signal clipping and introduces distortion.

The OPAx863 integrate an output short-circuit protection circuit that makes the device rugged for use in real-world applications.

#### 8.3.2.1 Overload Power Limit

The OPAx863 include overload power limiting that limits the increase in device quiescent current with output saturated to either of the supplies. Typically, when an amplifier output saturates, the two inputs are pulled apart, which can enable the slew-boost circuit. The input differential voltage is an error voltage in negative feedback that the amplifier core nullifies by engaging the slew-boost circuit and driving the output stage deeper into saturation. After the input to an amplifier attains a value large enough to saturate the output, any further increase in this input excitation results in a finite input differential voltage. As the output stage transistor is pushed deeper into saturation, the base-to-collector current gain ( $h_{FE}$ ) drops with an increase in the base and collector current, and an increase in the device quiescent current. This increase in quiescent current can cause a catastrophic failure in multichannel, high-gain, high-density front-end designs, and reduce operating lifetime in portable, battery-powered systems.

The OPAx863 overload power limiting includes an intelligent output saturation-detection circuit that limits the device quiescent current to 2.2-mA per channel under dc overload conditions. This increase in quiescent current is smaller with ac input or output and output saturation duration for only a fraction of the overall signal time period. [Table 8-1](#) compares the increase in quiescent current with 50-mV input overdrive for OPAx863 devices and other voltage-feedback amplifiers without overload power limit.

**Table 8-1. Quiescent Current With Saturated Outputs**

DEVICE	INPUT DIFFERENTIAL VOLTAGE	QUIESCENT CURRENT DURING OVERLOAD	INCREASE IN $I_Q$ FROM STEADY-STATE CONDITION
OPAx863 with overload power limit	50 mV	1.1 mA	1.57 ×
Competitor amplifier without overload power limit	50 mV	1.96 mA	3.43 ×

### 8.3.3 ESD Protection

As [Figure 8-1](#) shows, all device pins are protected with internal ESD protection diodes to the power supplies. These diodes provide moderate protection to input overdrive voltages greater than the supplies. The protection diodes typically support 10-mA continuous input and output currents. Use series current limiting resistors if input voltages exceeding the supply voltages occur at the amplifier inputs, which makes sure that the current through the ESD diodes remains within the rated value. OPAx863 is a bipolar amplifier; therefore, the two inputs are protected with antiparallel, back-to-back diodes between the inputs that limits the maximum input differential voltage to approximately 1 V. Make sure to use gain-setting and feedback resistors large enough to limit the current through these diodes in fast slewing conditions.

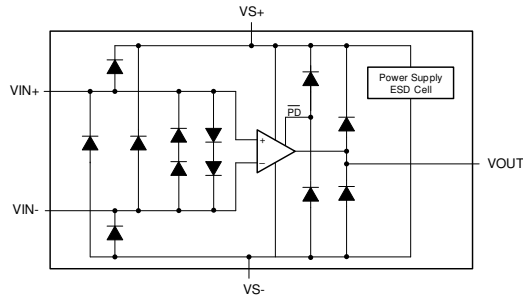

**Figure 8-1. Internal ESD Protection**

## 8.4 Device Functional Modes

### 8.4.1 Power-Down Mode

The OPAx863 includes a power-down mode for low-power standby operation with a quiescent current of only 1.5  $\mu\text{A}$  (maximum) with a 3-V supply and high output impedance. Many low-power systems are active for only a small time interval when the parameters of interest are measured and remain in low-power standby mode for a majority of the time and an overall small average power consumption. The OPAx863 enables such a low-power operation with quick turn-on within less than 6.5  $\mu\text{s}$ . See the *Electrical Characteristics* tables for power-down pin control thresholds.

Always drive  $\overline{\text{PD}}$  pin to avoid false triggering and oscillations. If power-down mode is not used, then connect the  $\overline{\text{PD}}$  pin to  $V_{S+}$ . For applications that need power-down mode, use an external pull-up resistor from the  $\overline{\text{PD}}$  pin to  $V_{S+}$  (driven with an open-collector power-down control logic).

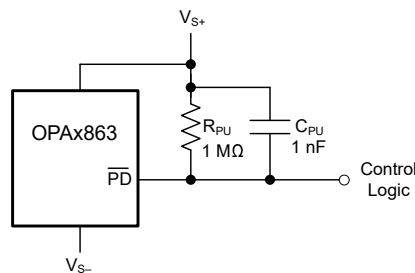

**Figure 8-2. Power Down Control**

[Figure 8-2](#) shows the choice of value of the pull-up resistor  $R_{PU}$ , which impacts the current consumption in power-down mode. Using a large  $R_{PU}$  reduces power consumption, but increases the noise at the PD pin, which can cause the amplifier to power down. A 1-nF capacitor can be used in parallel with  $R_{PU}$  to avoid coupling of external noise and false triggering. For the case of the  $\overline{\text{PD}}$  pin driven to  $V_{S-}$ , the  $I_{PU}$  current through  $R_{PU}$  is given as:

$$I_{PU} = \frac{V_{S+} - V_{S-}}{R_{PU}} \quad (1)$$

## 9 Application and Implementation

### Note

Information in the following applications sections is not part of the TI component specification, and TI does not warrant its accuracy or completeness. TI's customers are responsible for determining suitability of components for their purposes, as well as validating and testing their design implementation to confirm system functionality.

### 9.1 Application Information

The OPAx863 are classic voltage-feedback amplifiers with two high-impedance inputs and a low-impedance output. These devices have a GBW of 50 MHz, 5.9 nV/√Hz of noise, RRIO capability, and precision performance consuming only 700 μA quiescent current per channel. These features make the OPAx863 an excellent choice for use in low-side current sensing, ADC input driver, and reference buffering with fast settling, buffers, high gain and filter circuits. The overload power limit makes the OPAx863 truly low-power in high-gain, multichannel systems limiting any increase in quiescent current during output overload conditions.

### 9.2 Typical Applications

#### 9.2.1 Low-Side Current Sensing

Power converters use current-mode feedback control for excellent transient response and multiphase load sharing. Inverter stages control the phase currents for torque control in motor drives. As a result of the simplicity and low-cost, many of these topologies use difference-amplifier-based, low-side current sensing. Figure 9-1 shows the use of the OPAx863 in a difference amplifier circuit for low-side current sensing.

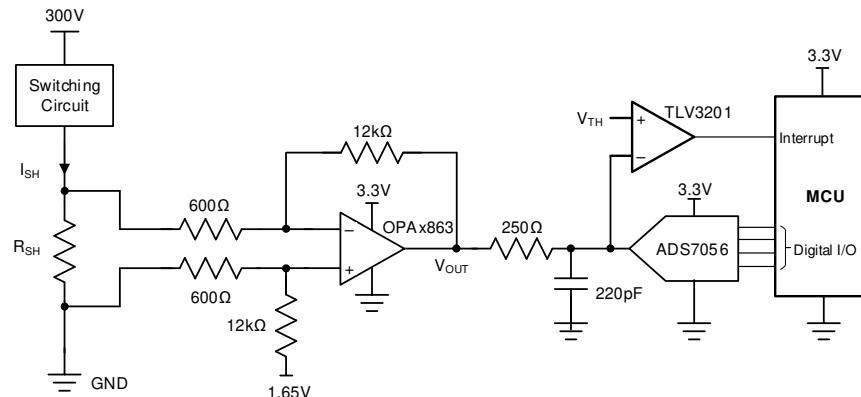

Figure 9-1. Low-Side Current Sensing in Power Converters

#### 9.2.1.1 Design Requirements

Table 9-1. Design Requirements

PARAMETER	DESIGN REQUIREMENT
Shunt resistor	10 mΩ
Input current	15 A <sub>PP</sub>
Output voltage	3 V <sub>PP</sub>
Switching frequency	50 kHz
Data acquisition	1 MSPS with 0.1% accuracy
Input voltage due to ground bounce	10 V <sub>pk</sub>



### 9.2.1.2 Detailed Design Procedure

In a difference amplifier circuit, the output voltage is given by:

$$V_O = \frac{R_F}{R_G} I_{SH} R_{SH} + V_{REF} \quad (2)$$

For lowest system noise, small values of  $R_F$  and  $R_G$  are preferred. The smallest value of  $R_G$  is limited by the input transient voltage (10 V here) seen by the circuit, and is given by:

$$R_G = \frac{V_{IN(max.)} - V_D - V_S}{I_{D(max.)}} \quad (3)$$

Where,

- $V_{IN(maximum)}$  is the maximum input transient voltage seen by the circuit.
- $V_D$  is the forward voltage drop of ESD diodes at the amplifier input.
- $I_{D(maximum)}$  is the maximum current rating of the ESD diodes at the amplifier input.

For a difference amplifier gain of 20 V/V, an  $R_F$  of 12 k $\Omega$  and  $R_G$  of 600  $\Omega$  are used. With a clock frequency of 40 MHz and the ADS7056 sampling at 1 MSPS, the available acquisition time for amplifier output settling is 550 ns. [Figure 9-2](#) shows the simulation results for the circuit in [Figure 9-1](#). The worst-case peak-to-peak input transient condition is simulated. The output of the OPAx863 device settles to within 0.1% accuracy within 543 ns. If using a slower clock frequency with the ADC is desired, then the acquisition time reduces with the same sampling rate, which degrades measurement accuracy. Alternatively, the sampling rate can be reduced to recover the required acquisition time and 0.1% accuracy.

### 9.2.1.3 Application Curves

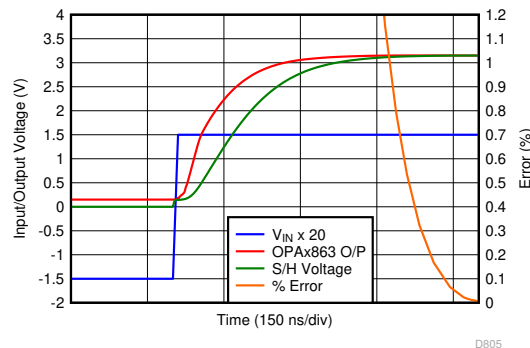

**Figure 9-2. 0.1% Settling Performance**

### 9.2.2 Front-End Gain and Filtering

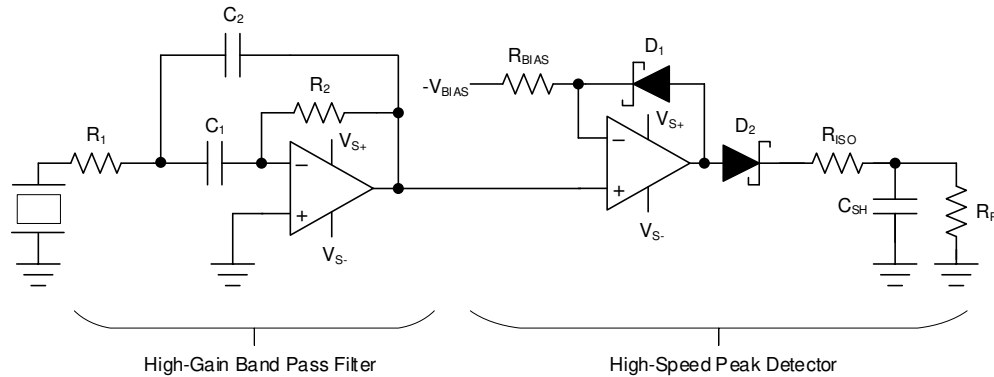
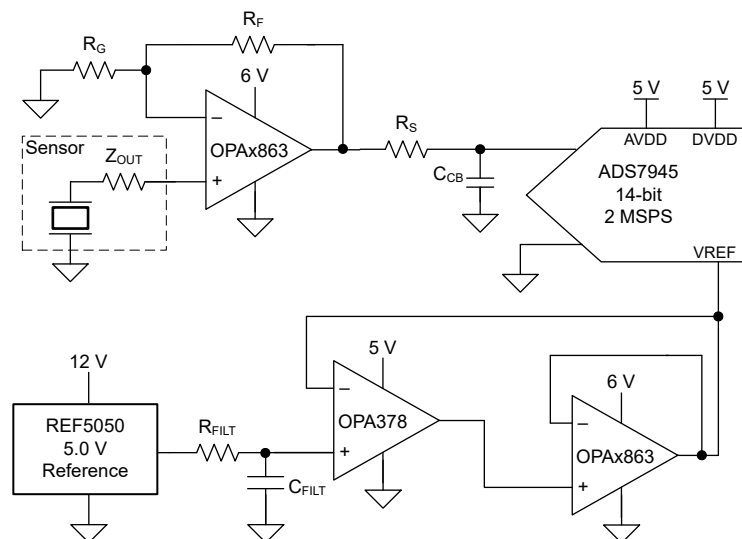

**Figure 9-3. High-Gain Narrow Bandpass Filter and Peak Detector Circuit**

Ultrasonic signaling is used for proximity and obstacle detection, level sensing, sonars, and so forth. Such signal chains detect the amplitude of received ultrasonic signal at a particular center frequency. [Figure 9-3](#) shows a high-gain narrow bandpass filter and peak detector circuit using any of the OPAx863 devices. The signal at the frequency of interest is filtered out, gained, and peak detected to report the amplitude at the output of this circuit. The phase information is lost in this circuit. The OPAx863 devices are used with the 50-MHz GBW to add a single-stage gain and filtering, and the peak detection capability is easily made with the RRIO capability of these amplifiers.

### 9.2.3 Low-Power SAR ADC Driver and Reference Buffer

[Figure 9-4](#) shows the use of the OPAx863 as a SAR ADC input driver and reference buffer driving the ADS7945 sensors, which are used for interface with the physical environment, exhibit high output impedance, and cannot drive SAR ADC inputs directly. A wide-GBW amplifier, such as the OPAx863, is needed to charge the switching capacitors at the SAR ADC input, and quickly settle to the required accuracy within the given acquisition time. The ADC core draws transient current from the reference input during the conversion (digitization) phase, which must be driven with a wide-GBW amplifier to offer fast settling and maintain a stable reference voltage for excellent digitization performance. The OPAx863 reference buffer is used in a composite loop with the [OPA378](#) precision amplifier because of limitations in precision performance of wide-GBW amplifiers. The precision amplifier maintains low-offset output, whereas the OPAx863 devices provide the output drive and fast-settling performance.



**Figure 9-4. OPAx863 as Low-Power SAR ADC Driver**

### 9.2.4 Variable Reference Generator Using MDAC

High-speed amplifiers can be used as a voltage buffer at MDAC output to generate a fast-settling variable reference voltage. [Figure 9-5](#) shows a representative circuit using [DAC8801](#) and [OPAx863](#).

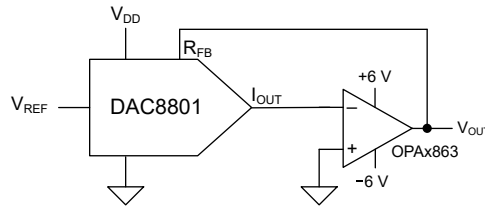
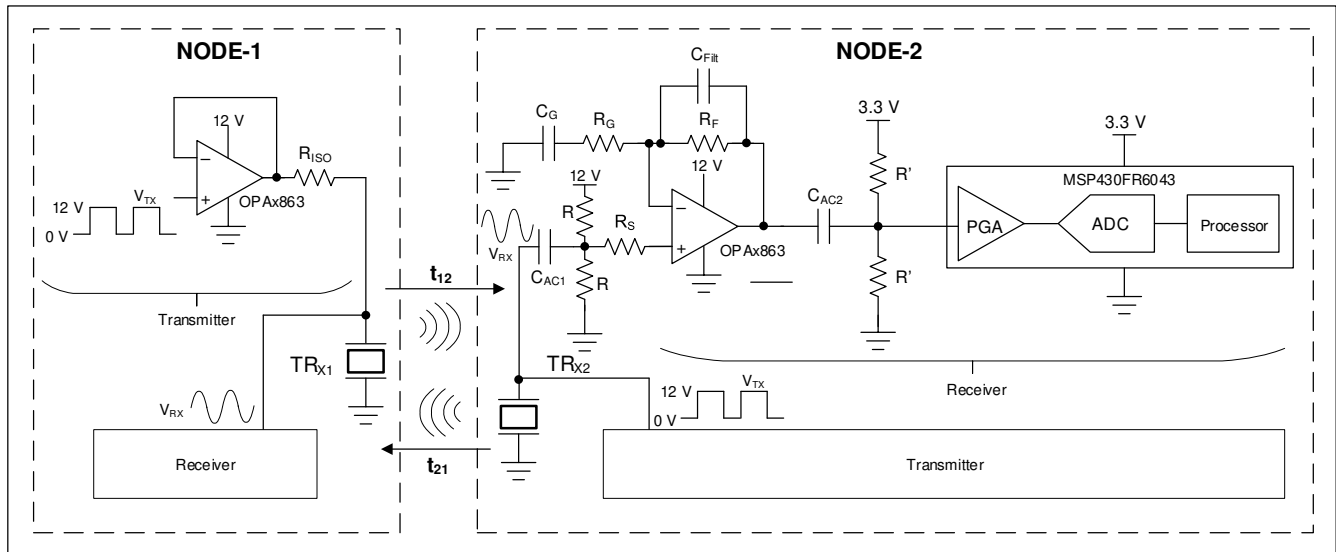

**Figure 9-5. Variable Reference Generator Using MDAC and OPAx863**

### 9.2.5 Clamp-On Ultrasonic Flow Meter

[Figure 9-6](#) shows how ultrasonic flow meters measure the rate of flow of a liquid using transit-time difference ( $t_{12}-t_{21}$ ), which depends on the flow rate. [Figure 9-6](#) shows a representative schematic for a non-intrusive ultrasonic flow meter using the [OPAx863](#) and 12-V transducer excitation. The [OPAx863](#) are used for the forward path as a unity-gain buffer for 12-V pulsed transducer excitation at **NODE 1**. At the same time, the receiver circuit at **NODE 2** (which also uses the [OPAx863](#)) first provides an ac-gain followed by a dc-level shift to lead to the PGA, ADC, and processor within the [MSP430™](#) microcontroller.

**NODE 2** and **NODE 1** use similar transmit and receive circuits (discussed previously) for the reverse path. The [OPAx863](#) wide GBW of 50 MHz introduces minimal phase-delay and low-noise for excellent flow rate measurement. The amplifier stays in power-down mode for a majority of the time in battery-powered systems. This configuration results in very small average system-level power consumption and prolonged battery lifetime with the 1.5- $\mu$ A (maximum) power-down mode quiescent current with a 3-V supply. The transmit and receive signal chains are connected to the same point at the respective node transducers. Therefore, the [OPAx863](#) 12.6-V supply voltage capability enables 12-V transducer excitation without any damage to the front-end, or a need for external switches, thus enabling a more compact solution. These specifications make the [OPAx863](#) an excellent choice for flow measurements in large diameter pipes and non-intrusive flow meters. The [TIDM-02003 reference design](#) discusses an ultrasonic gas flow sensing subsystem which uses high-speed amplifiers for front-end amplification.



**Figure 9-6. Non-Intrusive Ultrasonic Flow Meter**

## 9.3 Power Supply Recommendations

The OPAx863 is intended to operate on supplies ranging from 2.7 V to 12.6 V. The OPAx863 devices operate on single-sided supplies, split and balanced bipolar supplies, or unbalanced bipolar supplies. Operating from a single supply has numerous advantages. The dc errors, due to the  $-PSRR$  term, can be minimized with the negative supply at ground. Typically, ac performance improves slightly at 10-V operation with minimal increase in supply current. Minimize the distance ( $< 0.1$  in) from the power supply pins to high-frequency, 0.01- $\mu$ F decoupling capacitors. A larger capacitor (2.2  $\mu$ F typical) is used along with a high-frequency, 0.01- $\mu$ F supply-decoupling capacitor at the device supply pins. Only the positive supply has these capacitors for single-supply operation. Use these capacitors from each supply to ground when a split-supply is used. If necessary, place the larger capacitors further from the device and share these capacitors among several devices in the same area of the printed circuit board (PCB). An optional supply decoupling capacitor across the two power supplies (for split-supply operation) reduces second harmonic distortion.

## 9.4 Layout

### 9.4.1 Layout Guidelines

Achieving optimum performance with a high-frequency amplifier (like the OPAx863) requires careful attention to board layout parasitics and external component types. The [OPA2863 DGK Evaluation Module user's guide](#) can be used as a reference when designing the circuit board. Recommendations that optimize performance includes the following:

1. **Minimize parasitic capacitance** to any ac ground for all of the signal I/O pins. Parasitic capacitance on the output and inverting input pins can cause instability on the noninverting input and can react with the source impedance to cause unintentional band-limiting. Open a window around the signal I/O pins in all of the ground and power planes around those pins to reduce unwanted capacitance. Otherwise, ground and power planes must be unbroken elsewhere on the board.
2. **Minimize the distance** ( $< 0.1$  in) from the power-supply pins to high-frequency 0.01- $\mu$ F decoupling capacitors. Avoid narrow power and ground traces to minimize inductance between the pins and the decoupling capacitors. The power-supply connections must always be decoupled with these capacitors. Larger (2.2- $\mu$ F to 6.8- $\mu$ F) decoupling capacitors, effective at lower frequency, must also be used on the supply pins. These capacitors can be placed somewhat farther from the device and shared among several devices in the same area of the PCB.
3. **Careful selection and placement of external components preserves the high-frequency performance of the OPAx863.** Resistors must be a low reactance type. Surface-mount resistors work best and allow a tighter overall layout. Other network components, such as noninverting input termination resistors, must also be placed close to the package. Keep resistor values as low as possible and consistent with load-driving considerations. Lowering the resistor values keeps the resistor noise terms low and minimizes the effect of the parasitic capacitance. Lower resistor values, however, increase the dynamic power consumption because  $R_F$  and  $R_G$  become part of the amplifier output load network.

### 9.4.1.1 Thermal Considerations

The OPAx863 does not require heat sinking or airflow in most applications. The maximum allowed junction temperature sets the maximum allowed internal power dissipation. Do not allow the maximum junction temperature to exceed 150°C.

Operating junction temperature ( $T_J$ ) is given by,

$$T_J = T_A + P_D \times R_{\theta JA} \tag{4}$$

where

- $T_A$  is the ambient temperature
- $P_D$  is the total power dissipation internal to the amplifier
- $R_{\theta JA}$  is the junction-to-ambient thermal resistance

The total power dissipation  $P_D = P_{DQ} + P_{DL}$

where

- $P_{DQ} = (V_{S+} - V_{S-}) \times I_Q$ , is the power dissipation due to the amplifier quiescent current
- $P_{DL(max)} = V_S^2 / (4 \times R_L)$ , is the internal power dissipation due to the output load current

As a worst-case example, compute the maximum  $T_J$  using an OPA2863-DGK (VSSOP package) configured as a unity gain buffer, operating on  $\pm 6$ -V supplies at an ambient temperature of 25°C and driving a grounded 500- $\Omega$  load.

$$P_D = 12\text{ V} \times 2\text{ mA} + 6^2 / (4 \times 500\ \Omega) = 42\text{ mW} \tag{5}$$

Maximum  $T_J = 25^\circ\text{C} + (0.042\text{ W} \times 180.3^\circ\text{C/W}) = 33^\circ\text{C}$ , which is much less than the maximum allowed junction temperature of 150°C.

### 9.4.2 Layout Example

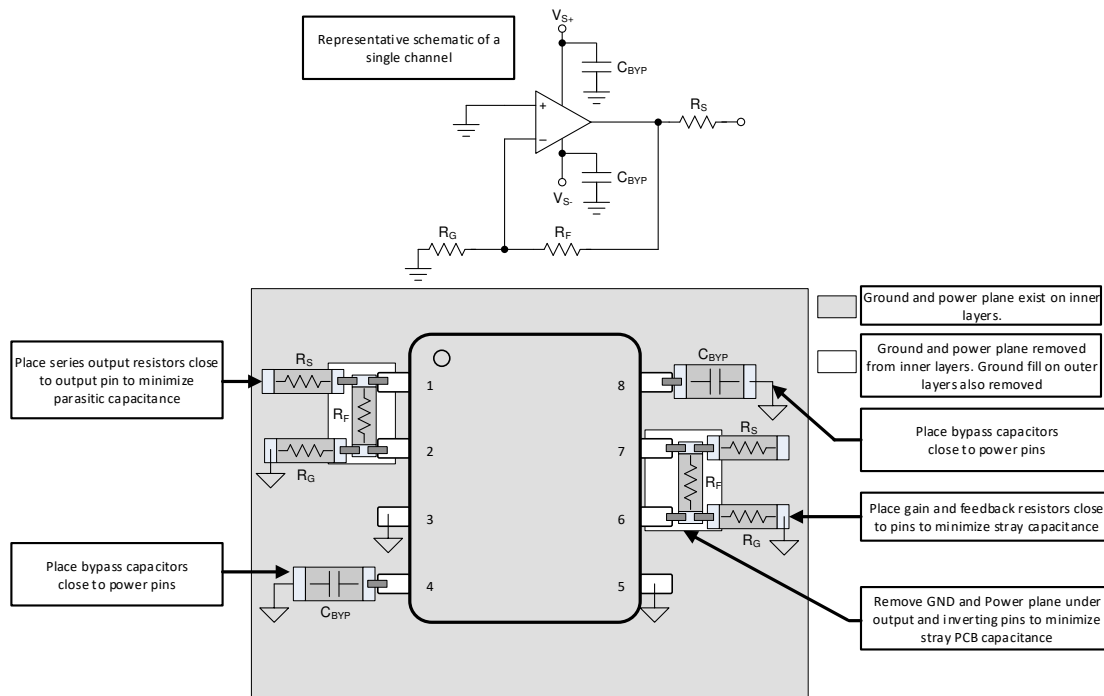

**Figure 9-7. Layout Recommendation for Dual-Channel DGK Package**

## 10 Device and Documentation Support

### 10.1 Documentation Support

#### 10.1.1 Related Documentation

For related documentation, see the following:

- Texas Instruments, [OPA2863ADGK Evaluation Module user's guide](#)
- Texas Instruments, [Single-Supply Op Amp Design Techniques application report](#)

#### 10.2 Receiving Notification of Documentation Updates

To receive notification of documentation updates, navigate to the device product folder on [ti.com](http://ti.com). Click on *Subscribe to updates* to register and receive a weekly digest of any product information that has changed. For change details, review the revision history included in any revised document.

#### 10.3 Support Resources

TI E2E™ [support forums](#) are an engineer's go-to source for fast, verified answers and design help — straight from the experts. Search existing answers or ask your own question to get the quick design help you need.

Linked content is provided "AS IS" by the respective contributors. They do not constitute TI specifications and do not necessarily reflect TI's views; see TI's [Terms of Use](#).

#### 10.4 Trademarks

MSP430™ and TI E2E™ are trademarks of Texas Instruments.

All trademarks are the property of their respective owners.

#### 10.5 Electrostatic Discharge Caution



This integrated circuit can be damaged by ESD. Texas Instruments recommends that all integrated circuits be handled with appropriate precautions. Failure to observe proper handling and installation procedures can cause damage.

ESD damage can range from subtle performance degradation to complete device failure. Precision integrated circuits may be more susceptible to damage because very small parametric changes could cause the device not to meet its published specifications.

#### 10.6 Glossary

[TI Glossary](#) This glossary lists and explains terms, acronyms, and definitions.

## 11 Mechanical, Packaging, and Orderable Information

The following pages include mechanical, packaging, and orderable information. This information is the most current data available for the designated devices. This data is subject to change without notice and revision of this document. For browser-based versions of this data sheet, refer to the left-hand navigation.

## PACKAGING INFORMATION

Orderable Device	Status (1)	Package Type	Package Drawing	Pins	Package Qty	Eco Plan (2)	Lead finish/ Ball material (6)	MSL Peak Temp (3)	Op Temp (°C)	Device Marking (4/5)	Samples
OPA2863DR	ACTIVE	SOIC	D	8	3000	RoHS & Green	NIPDAU	Level-1-260C-UNLIM	-40 to 125	O2863D	<a href="#">Samples</a>
OPA2863IDGKR	ACTIVE	VSSOP	DGK	8	2500	RoHS & Green	NIPDAUAG   SN	Level-2-260C-1 YEAR	-40 to 125	2FJ4	<a href="#">Samples</a>
OPA2863RUNR	ACTIVE	QFN	RUN	10	3000	RoHS & Green	NIPDAUAG	Level-2-260C-1 YEAR	-40 to 125	O263	<a href="#">Samples</a>
OPA4863PWR	ACTIVE	TSSOP	PW	14	3000	RoHS & Green	NIPDAU	Level-1-260C-UNLIM	-40 to 125	OPA4863	<a href="#">Samples</a>
OPA863DBVR	ACTIVE	SOT-23	DBV	5	3000	RoHS & Green	SN	Level-1-260C-UNLIM	-40 to 125	2QS5	<a href="#">Samples</a>
OPA863SIDBVR	ACTIVE	SOT-23	DBV	6	3000	RoHS & Green	SN	Level-1-260C-UNLIM	-40 to 125	O863	<a href="#">Samples</a>

(1) The marketing status values are defined as follows:

**ACTIVE:** Product device recommended for new designs.

**LIFEBUY:** TI has announced that the device will be discontinued, and a lifetime-buy period is in effect.

**NRND:** Not recommended for new designs. Device is in production to support existing customers, but TI does not recommend using this part in a new design.

**PREVIEW:** Device has been announced but is not in production. Samples may or may not be available.

**OBSOLETE:** TI has discontinued the production of the device.

(2) **RoHS:** TI defines "RoHS" to mean semiconductor products that are compliant with the current EU RoHS requirements for all 10 RoHS substances, including the requirement that RoHS substance do not exceed 0.1% by weight in homogeneous materials. Where designed to be soldered at high temperatures, "RoHS" products are suitable for use in specified lead-free processes. TI may reference these types of products as "Pb-Free".

**RoHS Exempt:** TI defines "RoHS Exempt" to mean products that contain lead but are compliant with EU RoHS pursuant to a specific EU RoHS exemption.

**Green:** TI defines "Green" to mean the content of Chlorine (Cl) and Bromine (Br) based flame retardants meet JS709B low halogen requirements of <=1000ppm threshold. Antimony trioxide based flame retardants must also meet the <=1000ppm threshold requirement.

(3) MSL, Peak Temp. - The Moisture Sensitivity Level rating according to the JEDEC industry standard classifications, and peak solder temperature.

(4) There may be additional marking, which relates to the logo, the lot trace code information, or the environmental category on the device.

(5) Multiple Device Markings will be inside parentheses. Only one Device Marking contained in parentheses and separated by a "-" will appear on a device. If a line is indented then it is a continuation of the previous line and the two combined represent the entire Device Marking for that device.

(6) Lead finish/Ball material - Orderable Devices may have multiple material finish options. Finish options are separated by a vertical ruled line. Lead finish/Ball material values may wrap to two lines if the finish value exceeds the maximum column width.

**Important Information and Disclaimer:** The information provided on this page represents TI's knowledge and belief as of the date that it is provided. TI bases its knowledge and belief on information provided by third parties, and makes no representation or warranty as to the accuracy of such information. Efforts are underway to better integrate information from third parties. TI has taken and continues to take reasonable steps to provide representative and accurate information but may not have conducted destructive testing or chemical analysis on incoming materials and chemicals. TI and TI suppliers consider certain information to be proprietary, and thus CAS numbers and other limited information may not be available for release.

In no event shall TI's liability arising out of such information exceed the total purchase price of the TI part(s) at issue in this document sold by TI to Customer on an annual basis.

**OTHER QUALIFIED VERSIONS OF OPA2863 :**

- Automotive : [OPA2863-Q1](#)

NOTE: Qualified Version Definitions:

- Automotive - Q100 devices qualified for high-reliability automotive applications targeting zero defects

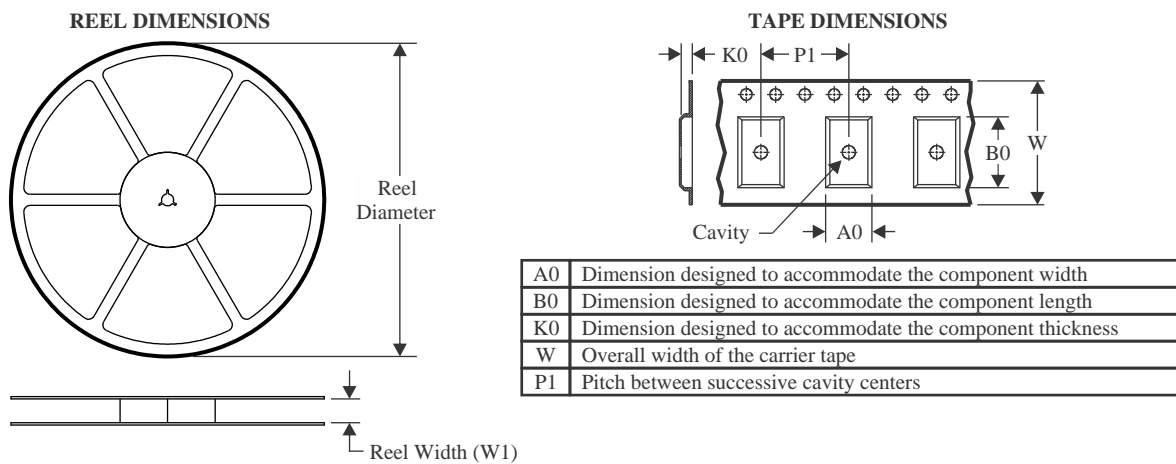

**TAPE AND REEL INFORMATION**

**QUADRANT ASSIGNMENTS FOR PIN 1 ORIENTATION IN TAPE**

\*All dimensions are nominal

Device	Package Type	Package Drawing	Pins	SPQ	Reel Diameter (mm)	Reel Width W1 (mm)	A0 (mm)	B0 (mm)	K0 (mm)	P1 (mm)	W (mm)	Pin1 Quadrant
OPA2863DR	SOIC	D	8	3000	330.0	12.4	6.4	5.2	2.1	8.0	12.0	Q1
OPA2863IDGKR	VSSOP	DGK	8	2500	330.0	12.4	5.3	3.4	1.4	8.0	12.0	Q1
OPA2863IDGKR	VSSOP	DGK	8	2500	330.0	12.4	5.3	3.4	1.4	8.0	12.0	Q1
OPA2863RUNR	QFN	RUN	10	3000	180.0	8.4	2.2	2.2	1.2	4.0	8.0	Q2
OPA4863PWR	TSSOP	PW	14	3000	330.0	12.4	6.9	5.6	1.6	8.0	12.0	Q1
OPA863DBVR	SOT-23	DBV	5	3000	178.0	9.0	3.3	3.2	1.4	4.0	8.0	Q3
OPA863SIDBVR	SOT-23	DBV	6	3000	178.0	9.0	3.3	3.2	1.4	4.0	8.0	Q3

**TAPE AND REEL BOX DIMENSIONS**

\*All dimensions are nominal

Device	Package Type	Package Drawing	Pins	SPQ	Length (mm)	Width (mm)	Height (mm)
OPA2863DR	SOIC	D	8	3000	356.0	356.0	35.0
OPA2863IDGKR	VSSOP	DGK	8	2500	366.0	364.0	50.0
OPA2863IDGKR	VSSOP	DGK	8	2500	366.0	364.0	50.0
OPA2863RUNR	QFN	RUN	10	3000	213.0	191.0	35.0
OPA4863PWR	TSSOP	PW	14	3000	356.0	356.0	35.0
OPA863DBVR	SOT-23	DBV	5	3000	180.0	180.0	18.0
OPA863SIDBVR	SOT-23	DBV	6	3000	190.0	190.0	30.0

# DBV0005A



## PACKAGE OUTLINE

SOT-23 - 1.45 mm max height

SMALL OUTLINE TRANSISTOR



### NOTES:

- All linear dimensions are in millimeters. Any dimensions in parenthesis are for reference only. Dimensioning and tolerancing per ASME Y14.5M.
- This drawing is subject to change without notice.
- Reference JEDEC MO-178.
- Body dimensions do not include mold flash, protrusions, or gate burrs. Mold flash, protrusions, or gate burrs shall not exceed 0.25 mm per side.
- Support pin may differ or may not be present.

# EXAMPLE BOARD LAYOUT

DBV0005A

SOT-23 - 1.45 mm max height

SMALL OUTLINE TRANSISTOR



LAND PATTERN EXAMPLE  
EXPOSED METAL SHOWN  
SCALE:15X

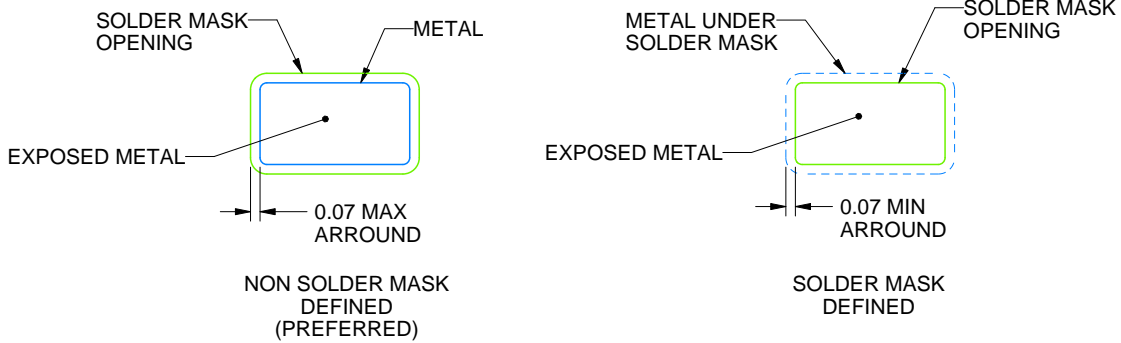

SOLDER MASK DETAILS

4214839/H 09/2023

NOTES: (continued)

- 6. Publication IPC-7351 may have alternate designs.
- 7. Solder mask tolerances between and around signal pads can vary based on board fabrication site.

# EXAMPLE STENCIL DESIGN

DBV0005A

SOT-23 - 1.45 mm max height

SMALL OUTLINE TRANSISTOR



SOLDER PASTE EXAMPLE  
BASED ON 0.125 mm THICK STENCIL  
SCALE:15X

4214839/H 09/2023

NOTES: (continued)

8. Laser cutting apertures with trapezoidal walls and rounded corners may offer better paste release. IPC-7525 may have alternate design recommendations.
9. Board assembly site may have different recommendations for stencil design.



# DBV0006A

# PACKAGE OUTLINE

## SOT-23 - 1.45 mm max height

SMALL OUTLINE TRANSISTOR

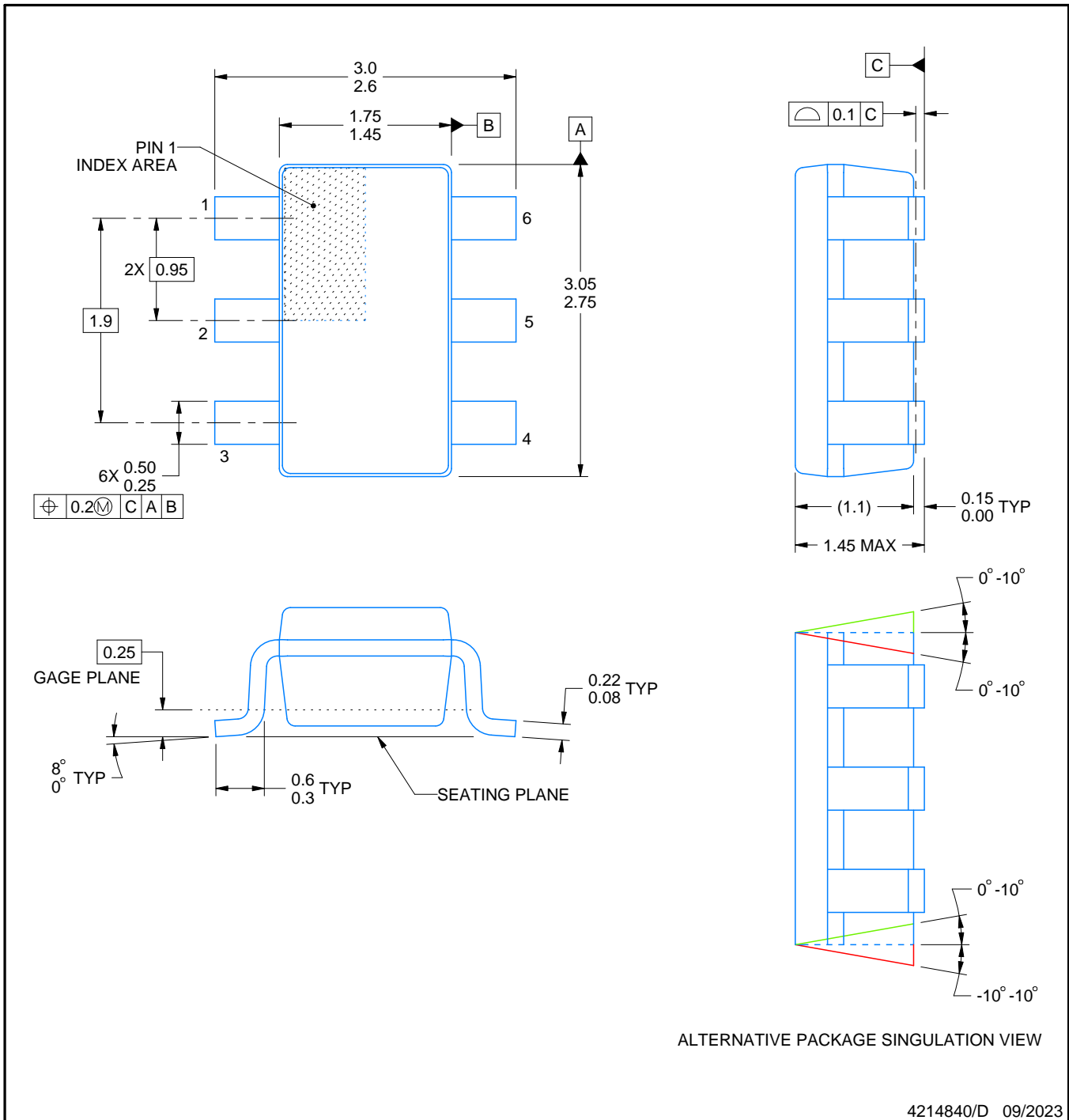

### NOTES:

1. All linear dimensions are in millimeters. Any dimensions in parenthesis are for reference only. Dimensioning and tolerancing per ASME Y14.5M.
2. This drawing is subject to change without notice.
3. Body dimensions do not include mold flash or protrusion. Mold flash and protrusion shall not exceed 0.25 per side.
4. Leads 1,2,3 may be wider than leads 4,5,6 for package orientation.
5. Reference JEDEC MO-178.

4214840/D 09/2023

# EXAMPLE BOARD LAYOUT

DBV0006A

SOT-23 - 1.45 mm max height

SMALL OUTLINE TRANSISTOR

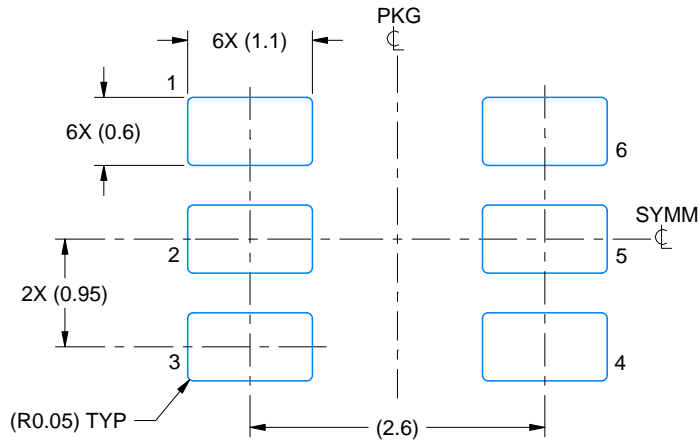

LAND PATTERN EXAMPLE  
EXPOSED METAL SHOWN  
SCALE:15X

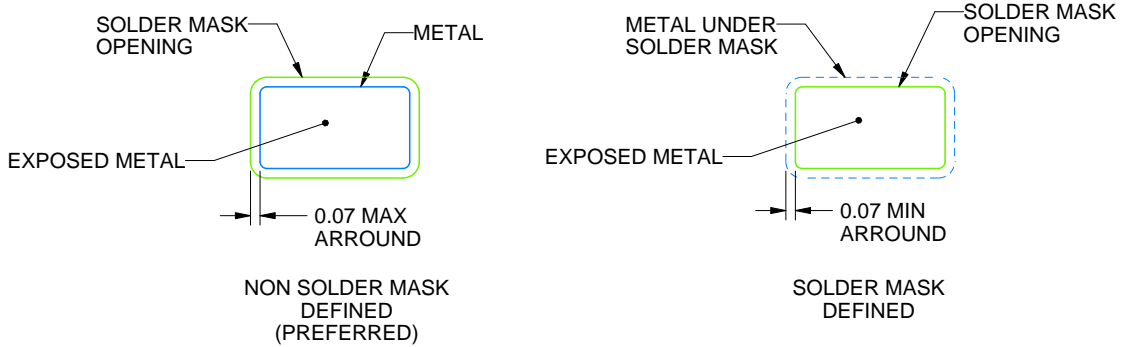

SOLDER MASK DETAILS

4214840/D 09/2023

NOTES: (continued)

- 6. Publication IPC-7351 may have alternate designs.
- 7. Solder mask tolerances between and around signal pads can vary based on board fabrication site.

# EXAMPLE STENCIL DESIGN

DBV0006A

SOT-23 - 1.45 mm max height

SMALL OUTLINE TRANSISTOR

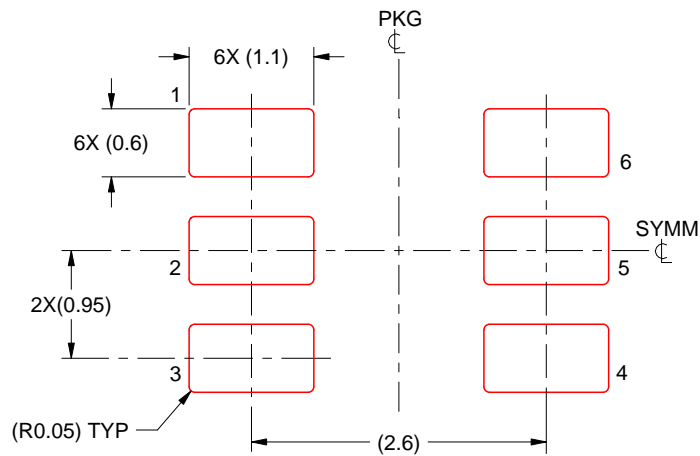

SOLDER PASTE EXAMPLE  
BASED ON 0.125 mm THICK STENCIL  
SCALE:15X

4214840/D 09/2023

NOTES: (continued)

8. Laser cutting apertures with trapezoidal walls and rounded corners may offer better paste release. IPC-7525 may have alternate design recommendations.
9. Board assembly site may have different recommendations for stencil design.



DGK (S-PDSO-G8)

PLASTIC SMALL-OUTLINE PACKAGE



- NOTES:
- A. All linear dimensions are in millimeters.
  - B. This drawing is subject to change without notice.
  - C. Body length does not include mold flash, protrusions, or gate burrs. Mold flash, protrusions, or gate burrs shall not exceed 0.15 per end.
  - D. Body width does not include interlead flash. Interlead flash shall not exceed 0.50 per side.
  - E. Falls within JEDEC MO-187 variation AA, except interlead flash.



- NOTES:
- A. All linear dimensions are in millimeters.
  - B. This drawing is subject to change without notice.
  - C. Publication IPC-7351 is recommended for alternate designs.
  - D. Laser cutting apertures with trapezoidal walls and also rounding corners will offer better paste release. Customers should contact their board assembly site for stencil design recommendations. Refer to IPC-7525 for other stencil recommendations.
  - E. Customers should contact their board fabrication site for solder mask tolerances between and around signal pads.

PW (R-PDSO-G14)

PLASTIC SMALL OUTLINE



- NOTES:
- A. All linear dimensions are in millimeters. Dimensioning and tolerancing per ASME Y14.5M-1994.
  - B. This drawing is subject to change without notice.
  - C. Body length does not include mold flash, protrusions, or gate burrs. Mold flash, protrusions, or gate burrs shall not exceed 0,15 each side.
  - D. Body width does not include interlead flash. Interlead flash shall not exceed 0,25 each side.
  - E. Falls within JEDEC MO-153

PW (R-PDSO-G14)

PLASTIC SMALL OUTLINE



- NOTES:
- All linear dimensions are in millimeters.
  - This drawing is subject to change without notice.
  - Publication IPC-7351 is recommended for alternate designs.
  - Laser cutting apertures with trapezoidal walls and also rounding corners will offer better paste release. Customers should contact their board assembly site for stencil design recommendations. Refer to IPC-7525 for other stencil recommendations.
  - Customers should contact their board fabrication site for solder mask tolerances between and around signal pads.

## GENERIC PACKAGE VIEW

**RUN 10**

**WQFN - 0.8 mm max height**

2 X 2, 0.5 mm pitch

PLASTIC QUAD FLATPACK - NO LEAD

This image is a representation of the package family, actual package may vary.  
Refer to the product data sheet for package details.

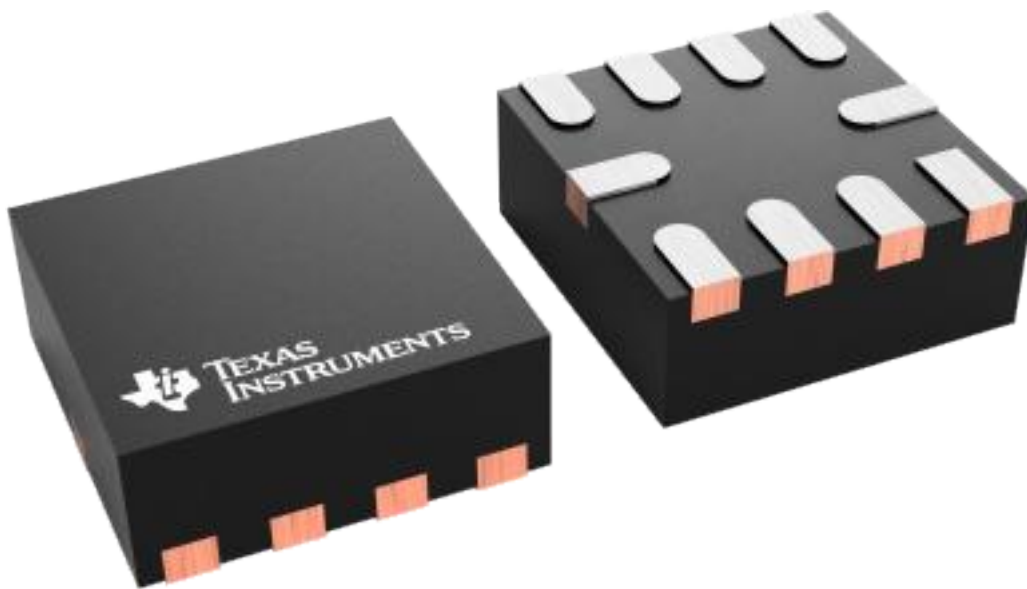

4228249/A

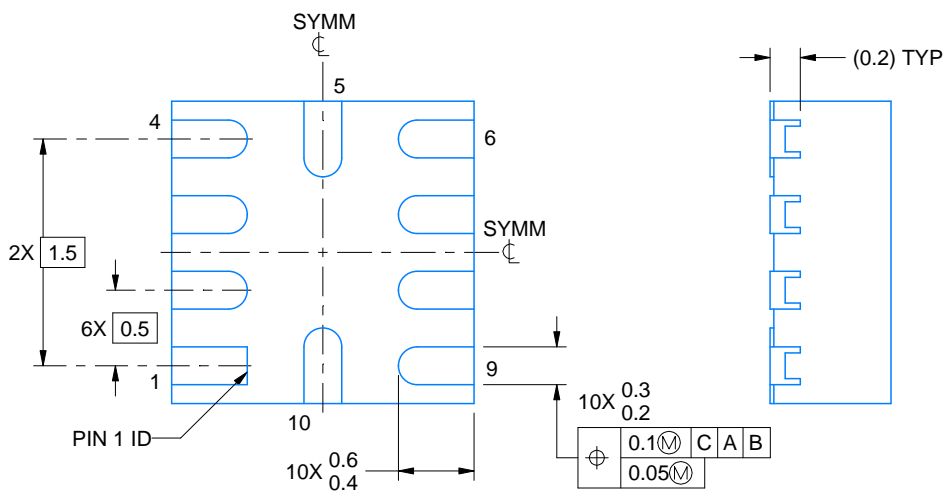
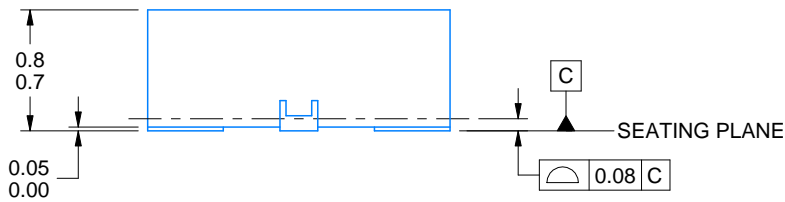
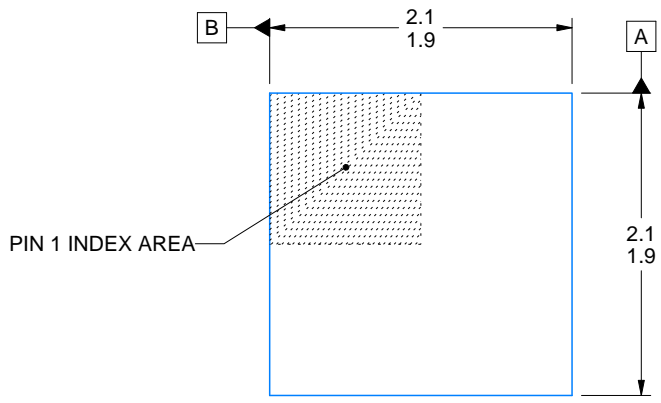
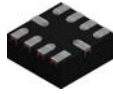

4226925/A 08/2021

NOTES:

1. All linear dimensions are in millimeters. Any dimensions in parenthesis are for reference only. Dimensioning and tolerancing per ASME Y14.5M.
2. This drawing is subject to change without notice.

# EXAMPLE BOARD LAYOUT

RUN0010B

WQFN - 0.8 mm max height

PLASTIC QUAD FLATPACK - NO LEAD

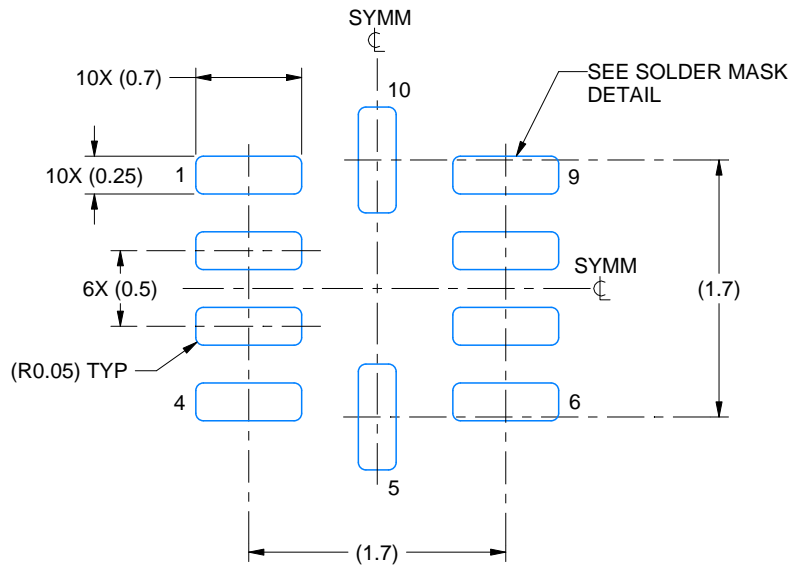

LAND PATTERN EXAMPLE  
EXPOSED METAL SHOWN  
SCALE: 20X

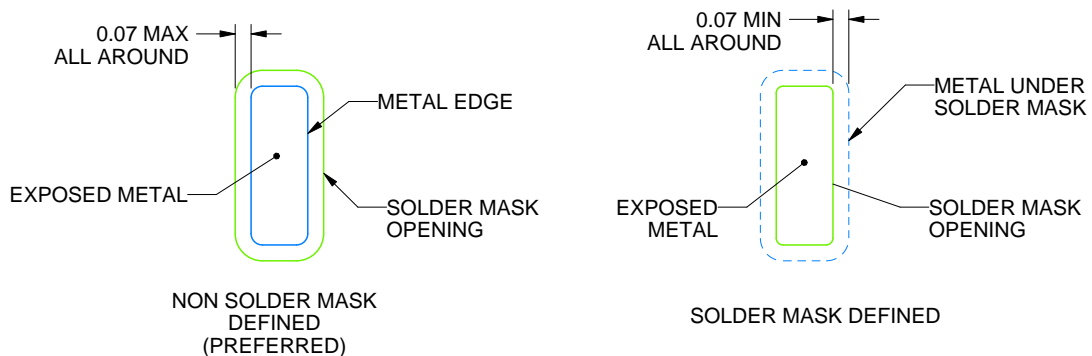

SOLDER MASK DETAILS

4226925/A 08/2021

NOTES: (continued)

- This package is designed to be soldered to a thermal pad on the board. For more information, see Texas Instruments literature number SLUA271 ([www.ti.com/lit/slua271](http://www.ti.com/lit/slua271)).

# EXAMPLE STENCIL DESIGN

RUN0010B

WQFN - 0.8 mm max height

PLASTIC QUAD FLATPACK - NO LEAD

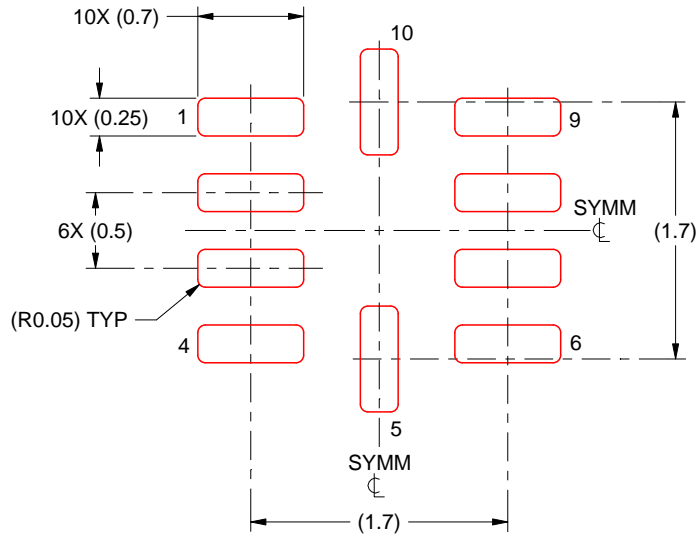

SOLDER PASTE EXAMPLE  
BASED ON 0.125 MM THICK STENCIL  
SCALE: 20X

4226925/A 08/2021

NOTES: (continued)

4. Laser cutting apertures with trapezoidal walls and rounded corners may offer better paste release. IPC-7525 may have alternate design recommendations.



# D0008A



# PACKAGE OUTLINE

## SOIC - 1.75 mm max height

SMALL OUTLINE INTEGRATED CIRCUIT



4214825/C 02/2019

### NOTES:

1. Linear dimensions are in inches [millimeters]. Dimensions in parenthesis are for reference only. Controlling dimensions are in inches. Dimensioning and tolerancing per ASME Y14.5M.
2. This drawing is subject to change without notice.
3. This dimension does not include mold flash, protrusions, or gate burrs. Mold flash, protrusions, or gate burrs shall not exceed .006 [0.15] per side.
4. This dimension does not include interlead flash.
5. Reference JEDEC registration MS-012, variation AA.

# EXAMPLE BOARD LAYOUT

D0008A

SOIC - 1.75 mm max height

SMALL OUTLINE INTEGRATED CIRCUIT



LAND PATTERN EXAMPLE  
EXPOSED METAL SHOWN  
SCALE:8X



SOLDER MASK DETAILS

4214825/C 02/2019

NOTES: (continued)

- 6. Publication IPC-7351 may have alternate designs.
- 7. Solder mask tolerances between and around signal pads can vary based on board fabrication site.

# EXAMPLE STENCIL DESIGN

D0008A

SOIC - 1.75 mm max height

SMALL OUTLINE INTEGRATED CIRCUIT



SOLDER PASTE EXAMPLE  
BASED ON .005 INCH [0.125 MM] THICK STENCIL  
SCALE:8X

4214825/C 02/2019

NOTES: (continued)

8. Laser cutting apertures with trapezoidal walls and rounded corners may offer better paste release. IPC-7525 may have alternate design recommendations.
9. Board assembly site may have different recommendations for stencil design.

## IMPORTANT NOTICE AND DISCLAIMER

TI PROVIDES TECHNICAL AND RELIABILITY DATA (INCLUDING DATA SHEETS), DESIGN RESOURCES (INCLUDING REFERENCE DESIGNS), APPLICATION OR OTHER DESIGN ADVICE, WEB TOOLS, SAFETY INFORMATION, AND OTHER RESOURCES "AS IS" AND WITH ALL FAULTS, AND DISCLAIMS ALL WARRANTIES, EXPRESS AND IMPLIED, INCLUDING WITHOUT LIMITATION ANY IMPLIED WARRANTIES OF MERCHANTABILITY, FITNESS FOR A PARTICULAR PURPOSE OR NON-INFRINGEMENT OF THIRD PARTY INTELLECTUAL PROPERTY RIGHTS.

These resources are intended for skilled developers designing with TI products. You are solely responsible for (1) selecting the appropriate TI products for your application, (2) designing, validating and testing your application, and (3) ensuring your application meets applicable standards, and any other safety, security, regulatory or other requirements.

These resources are subject to change without notice. TI grants you permission to use these resources only for development of an application that uses the TI products described in the resource. Other reproduction and display of these resources is prohibited. No license is granted to any other TI intellectual property right or to any third party intellectual property right. TI disclaims responsibility for, and you will fully indemnify TI and its representatives against, any claims, damages, costs, losses, and liabilities arising out of your use of these resources.

TI's products are provided subject to [TI's Terms of Sale](#) or other applicable terms available either on [ti.com](https://www.ti.com) or provided in conjunction with such TI products. TI's provision of these resources does not expand or otherwise alter TI's applicable warranties or warranty disclaimers for TI products.

TI objects to and rejects any additional or different terms you may have proposed.

Mailing Address: Texas Instruments, Post Office Box 655303, Dallas, Texas 75265  
Copyright © 2024, Texas Instruments Incorporated

## X-ON Electronics

Largest Supplier of Electrical and Electronic Components

*Click to view similar products for [High Speed Operational Amplifiers](#) category:*

*Click to view products by [Texas Instruments](#) manufacturer:*

Other Similar products are found below :

[LTC6406CUD#PBF](#) [NJU7047RB1-TE2](#) [EL2250CSZ-T7](#) [EL5111IYEZ](#) [EL5167IWZ-T7](#) [EL5202IYZ](#) [EL5204IYZ](#) [EL8108IL](#) [EL8108IS](#)  
[EL8401IS](#) [EL8401IU](#) [EL8403IS](#) [EL8403IU](#) [HFA1100IB](#) [HFA1100IP](#) [HFA1105IB](#) [HFA1109IB](#) [ADA4897-2ARMZ-R7](#) [OPA2863DR](#)  
[OPA863DBVR](#) [AD8099ARDZ-REEL](#) [LT1007CS8#TRPBF](#) [LTC6252IS6#TRMPBF](#) [LT6203IMS8#TRPBF](#) [LTC6253CMS8#TRPBF](#)  
[LT1801CMS8#TRPBF](#) [AD8009ARZ-REEL](#) [OPA2835IDR](#) [THS3095DDAR](#) [LMH6629MFX/NOPB](#) [OPA814DR](#) [OPA659IDBVR](#)  
[THS4031IDR](#) [OPA2301AIDGKR](#) [LT6202IS5#TRPBF](#) [OPA607IDCKR](#) [LT6202CS5#PBF](#) [THS3115CPWPR](#) [BUF602IDBVR](#)  
[THS3215IRGVR](#) [ADA4895-2ARMZ-R7](#) [OPA356AQDBVRQ1](#) [THS4221DBVR](#) [ADA4858-3ACPZ-R7](#) [OPA2683IDCNR](#) [ADA4805-2ARMZ-R7](#)  
[ADA4851-2YRMZ-RL](#) [OPA2836QDGKRQ1](#) [LT1223CN8#PBF](#) [LT1220CN8#PBF](#)