

TL3474, TL3474A

HIGH-SLEW-RATE, SINGLE-SUPPLY OPERATIONAL AMPLIFIERS

SLVS461B – JANUARY 2003 – REVISED JULY 2003

- Low Offset . . . 3 mV (Max) for A-Grade
- Wide Gain-Bandwidth Product . . . 4 MHz
- High Slew Rate . . . 13 V/ μ s
- Fast Settling Time . . . 1.1 μ s to 0.1%
- Wide-Range Single-Supply Operation . . . 4 V to 36 V
- Wide Input Common-Mode Range Includes Ground (V_{CC-})
- Low Total Harmonic Distortion . . . 0.02%
- Large-Capacitance Drive Capability . . . 10,000 pF
- Output Short-Circuit Protection
- Alternative to MC33074/A and MC34074/A

D, N, OR PW PACKAGE
(TOP VIEW)

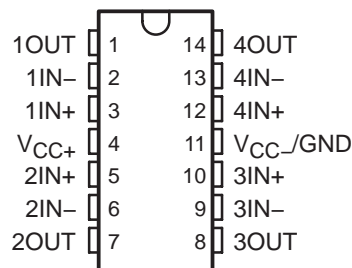

description/ordering information

ORDERING INFORMATION

T_A	V_{IOmax} AT 25°C	PACKAGE†		ORDERABLE PART NUMBER	TOP-SIDE MARKING
0°C to 70°C	A-grade: 3 mV	PDIP (N)	Tube of 25	TL3474ACN	TL3474ACN
		SOIC (D)	Tube of 50	TL3474ACD	TL3474A
			Reel of 2500	TL3474ACDR	
	TSSOP (PW)	Tube of 90	TL3474ACPW	T3474A	
		Reel of 2000	TL3474ACPWR		
	0°C to 70°C	Standard grade: 10 mV	PDIP (N)	Tube of 25	TL3474CN
SOIC (D)			Tube of 50	TL3474CD	TL3474C
			Reel of 2500	TL3474CDR	
TSSOP (PW)		Tube of 90	TL3474CPW	TL3474	
		Reel of 2000	TL3474CPWR		
-40°C to 105°C		A-grade: 3 mV	PDIP (N)	Tube of 25	TL3474AIN
	SOIC (D)		Tube of 50	TL3474AID	TL3474AI
			Reel of 2500	TL3474AIDR	
	TSSOP (PW)	Tube of 90	TL3474AIPW	Z3474A	
		Reel of 2000	TL3474AIPWR		
	Standard grade: 10 mV	PDIP (N)	Tube of 25	TL3474IIN	TL3474IIN
SOIC (D)		Tube of 50	TL3474IID	TL3474I	
		Reel of 2500	TL3474IIDR		
TSSOP (PW)	Tube of 90	TL3474IPW	Z3474		
Reel of 2000	TL3474IPWR				

† Package drawings, standard packing quantities, thermal data, symbolization, and PCB design guidelines are available at www.ti.com/sc/package.



Please be aware that an important notice concerning availability, standard warranty, and use in critical applications of Texas Instruments semiconductor products and disclaimers thereto appears at the end of this data sheet.

PRODUCTION DATA information is current as of publication date. Products conform to specifications per the terms of Texas Instruments standard warranty. Production processing does not necessarily include testing of all parameters.

**TEXAS
INSTRUMENTS**

POST OFFICE BOX 655303 • DALLAS, TEXAS 75265

Copyright © 2003, Texas Instruments Incorporated

TL3474, TL3474A HIGH-SLEW-RATE, SINGLE-SUPPLY OPERATIONAL AMPLIFIERS

SLVS461B – JANUARY 2003 – REVISED JULY 2003

description/ordering information (continued)

Quality, low-cost, bipolar fabrication with innovative design concepts is employed for the TL3474, TL3474A operational amplifiers. These devices offer 4 MHz of gain-bandwidth product, 13-V/ μ s slew rate, and fast settling time without the use of JFET device technology. Although the TL3474 and TL3474A can be operated from split supplies, they are particularly suited for single-supply operation because the common-mode input voltage range includes ground potential (V_{CC-}). With a Darlington transistor input stage, these devices exhibit high input resistance, low input offset voltage, and high gain. The all-npn output stage, characterized by no dead-band crossover distortion and large output voltage swing, provides high-capacitance drive capability, excellent phase and gain margins, low open-loop high-frequency output impedance, and symmetrical source/sink ac frequency response. These low-cost amplifiers are an alternative to the MC34074/A and MC33074/A operational amplifiers.

schematic (each amplifier)

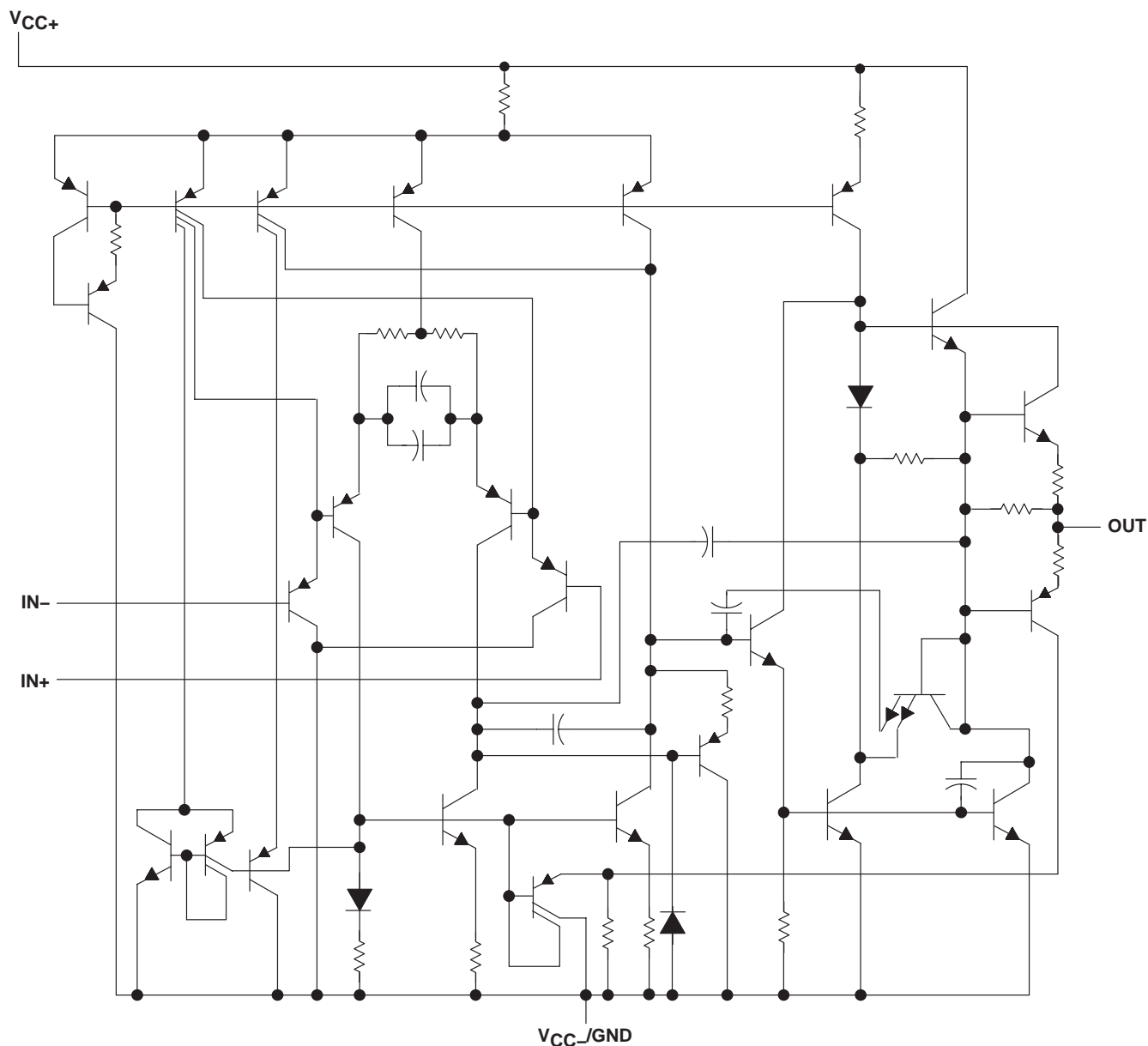

TL3474, TL3474A

HIGH-SLEW-RATE, SINGLE-SUPPLY OPERATIONAL AMPLIFIERS

SLVS461B – JANUARY 2003 – REVISED JULY 2003

absolute maximum ratings over operating free-air temperature range (unless otherwise noted)†

Supply voltage: V_{CC+} (see Note 1)	18 V
V_{CC-}	-18 V
Differential input voltage, V_{ID} (see Note 2)	± 36 V
Input voltage, V_I (any input)	$V_{CC\pm}$
Input current, I_I (each input)	± 1 mA
Output current, I_O	± 80 mA
Total current into V_{CC+}	80 mA
Total current out of V_{CC-}	80 mA
Duration of short-circuit current at (or below) 25°C (see Note 3)	Unlimited
Package thermal impedance, θ_{JA} (see Notes 4 and 5): D package	86°C/W
N package	80°C/W
PW package	113°C/W
Operating virtual junction temperature, T_J	150°C
Lead temperature 1.6 mm (1/16 inch) from case for 10 seconds	260°C
Storage temperature range, T_{stg}	-65°C to 150°C

† Stresses beyond those listed under “absolute maximum ratings” may cause permanent damage to the device. These are stress ratings only, and functional operation of the device at these or any other conditions beyond those indicated under “recommended operating conditions” is not implied. Exposure to absolute-maximum-rated conditions for extended periods may affect device reliability.

- NOTES:
1. All voltage values, except differential voltages, are with respect to the midpoint between V_{CC+} and V_{CC-}/GND .
 2. Differential voltages are at the noninverting input with respect to the inverting input. Excessive input current can flow when the input is less than $V_{CC-} - 0.3$ V.
 3. The output can be shorted to either supply. Temperature and/or supply voltages must be limited to ensure that the maximum dissipation rating is not exceeded.
 4. Maximum power dissipation is a function of $T_J(\max)$, θ_{JA} , and T_A . The maximum allowable power dissipation at any allowable ambient temperature is $P_D = (T_J(\max) - T_A)/\theta_{JA}$. Operating at the absolute maximum T_J of 150°C can affect reliability.
 5. The package thermal impedance is calculated in accordance with JEDEC 51-7.

recommended operating conditions

		MIN	MAX	UNIT	
$V_{CC\pm}$	Supply voltage	4	36	V	
V_{IC}	Common-mode input voltage	$V_{CC} = 5$ V	0	2.8	V
		$V_{CC\pm} = \pm 15$ V	-15	12.8	
T_A	Operating free-air temperature	TL3474C, TL3474AC	0	70	°C
		TL3474I, TL3474AI	-40	105	



TL3474, TL3474A HIGH-SLEW-RATE, SINGLE-SUPPLY OPERATIONAL AMPLIFIERS

SLVS461B – JANUARY 2003 – REVISED JULY 2003

electrical characteristics at specified free-air temperature, $V_{CC\pm} = \pm 15\text{ V}$ (unless otherwise noted)

PARAMETER	TEST CONDITIONS	T _A	TL3474			TL3474A			UNIT
			MIN	TYP†	MAX	MIN	TYP†	MAX	
V _{IO} Input offset voltage	V _{IC} = 0, V _O = 0, R _S = 50 Ω	V _{CC} = 5 V	25°C	1.5	10	1.5	3	mV	
		V _{CC} = ±15 V	25°C	1.0	10	1.0	3		
			Full range‡			12			5
αV _{IO} Temperature coefficient of input offset voltage	V _{IC} = 0, V _O = 0, R _S = 50 Ω	V _{CC} = ±15 V	Full range‡	10		10		μV/°C	
I _{IO} Input offset current		V _{CC} = ±15 V	25°C	6	75	6	75	nA	
			Full range‡		300		300		
I _{IB} Input bias current	V _{CC} = ±15 V	25°C	100	500	100	500	nA		
		Full range‡		700		700			
V _{ICR} Common-mode input voltage range	R _S = 50 Ω	25°C	-15 to 12.8		-15 to 12.8		V		
		Full range‡	-15 to 12.8		-15 to 12.8				
V _{OH} High-level output voltage	V _{CC+} = 5 V, V _{CC-} = 0, R _L = 2 kΩ	25°C	3.7	4	3.7	4	V		
	R _L = 10 kΩ	25°C	13.6	14	13.6	14			
	R _L = 2 kΩ	Full range‡	13.4		13.4				
V _{OL} Low-level output voltage	V _{CC+} = 5 V, V _{CC-} = 0, R _L = 2 kΩ	25°C	0.1	0.3	0.1	0.3	V		
	R _L = 10 kΩ	25°C	-14.7	-14.3	-14.7	-14.3			
	R _L = 2 kΩ	Full range‡		-13.5		-13.5			
A _{VD} Large-signal differential voltage amplification	V _O = ±10 V, R _L = 2 kΩ	25°C	25	100	25	100	V/mV		
		Full range‡	20		20				
I _{OS} Short-circuit output current	Source: V _{ID} = 1 V, V _O = 0	25°C	-10	-34	-10	-34	mA		
	Sink: V _{ID} = -1 V, V _O = 0		20	27	20	27			
CMRR Common-mode rejection ratio	V _{IC} = V _{ICR} (min), R _S = 50 Ω	25°C	65	97	80	97	dB		
k _{SVR} Supply-voltage rejection ratio (ΔV _{CC±} /ΔV _{IO})	V _{CC±} = ±13.5 V to ±16.5 V, R _S = 100 Ω	25°C	70	97	70	97	dB		
I _{CC} Supply current (per channel)	V _O = 0, No load	25°C	3.5	4.5	3.5	4.5	mA		
		Full range‡	4.5	5.5	4.5	5.5			
	V _{CC+} = 5 V, V _O = 2.5 V, V _{CC-} = 0, No load	25°C	3.5	4.5	3.5	4.5			

† All typical values are at T_A = 25°C.

‡ Full range is 0°C to 70°C for the TL3474C, TL3474AC devices and -40°C to 105°C for the TL3474I, TL3474AI devices.



TL3474, TL3474A

HIGH-SLEW-RATE, SINGLE-SUPPLY OPERATIONAL AMPLIFIERS

SLVS461B – JANUARY 2003 – REVISED JULY 2003

operating characteristics, $V_{CC\pm} = \pm 15\text{ V}$, $T_A = 25^\circ\text{C}$

PARAMETER		TEST CONDITIONS		TL3474			TL3474A			UNIT
				MIN	TYP	MAX	MIN	TYP	MAX	
SR+	Positive slew rate	$V_I = -10\text{ V to } 10\text{ V}$, $R_L = 2\text{ k}\Omega$, $C_L = 300\text{ pF}$	$A_V = 1$	8	10		8	10	$\text{V}/\mu\text{s}$	
SR-	Negative slew rate		$A_V = -1$		13		13			
t_s	Settling time	$A_{VD} = -1$, 10-V step	To 0.1%		1.1		1.1		μs	
			To 0.01%		2.2		2.2			
V_n	Equivalent input noise voltage	$f = 1\text{ kHz}$,	$R_S = 100\ \Omega$		49		49		$\text{nV}/\sqrt{\text{Hz}}$	
I_n	Equivalent input noise current	$f = 1\text{ kHz}$			0.22		0.22		$\text{pA}/\sqrt{\text{Hz}}$	
THD	Total harmonic distortion	$V_{O(PP)} = 2\text{ V to } 20\text{ V}$, $R_L = 2\text{ k}\Omega$, $A_{VD} = 10$, $f = 10\text{ kHz}$			0.02		0.02		%	
GBW	Gain-bandwidth product	$f = 100\text{ kHz}$		3	4		3	4	MHz	
BW	Power bandwidth	$V_{O(PP)} = 20\text{ V}$, $R_L = 2\text{ k}\Omega$, $A_{VD} = 1$, THD = 5.0%			160		160		kHz	
ϕ_m	Phase margin	$R_L = 2\text{ k}\Omega$,	$C_L = 0$		70		70		deg	
		$R_L = 2\text{ k}\Omega$,	$C_L = 300\text{ pF}$		50		50			
	Gain margin	$R_L = 2\text{ k}\Omega$,	$C_L = 0$		12		12		dB	
		$R_L = 2\text{ k}\Omega$,	$C_L = 300\text{ pF}$		4		4			
r_i	Differential input resistance	$V_{IC} = 0$			150		150		$\text{M}\Omega$	
C_i	Input capacitance	$V_{IC} = 0$			2.5		2.5		pF	
	Channel separation	$f = 10\text{ kHz}$			101		101		dB	
z_o	Open-loop output impedance	$f = 1\text{ MHz}$,	$A_V = 1$		20		20		Ω	

TL3474, TL3474A HIGH-SLEW-RATE, SINGLE-SUPPLY OPERATIONAL AMPLIFIERS

SLVS461B – JANUARY 2003 – REVISED JULY 2003

TYPICAL CHARACTERISTICS ($T_A = 25^\circ\text{C}$ UNLESS OTHERWISE NOTED)

**OUTPUT IMPEDANCE
VS
FREQUENCY**

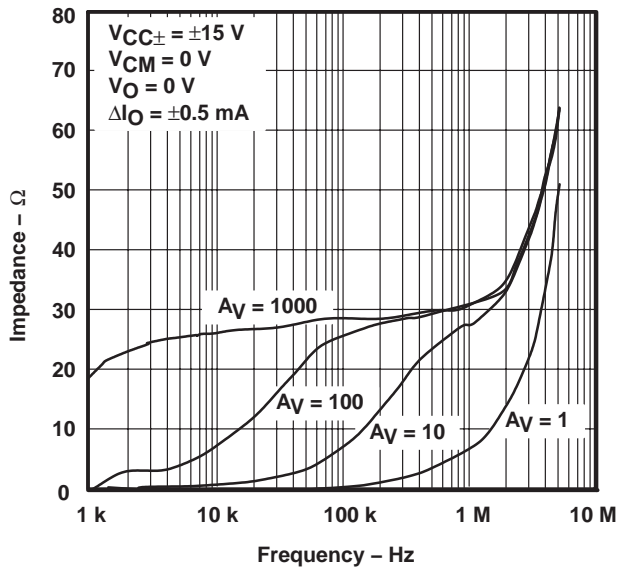

Figure 1

**TOTAL HARMONIC DISTORTION
VS
FREQUENCY**

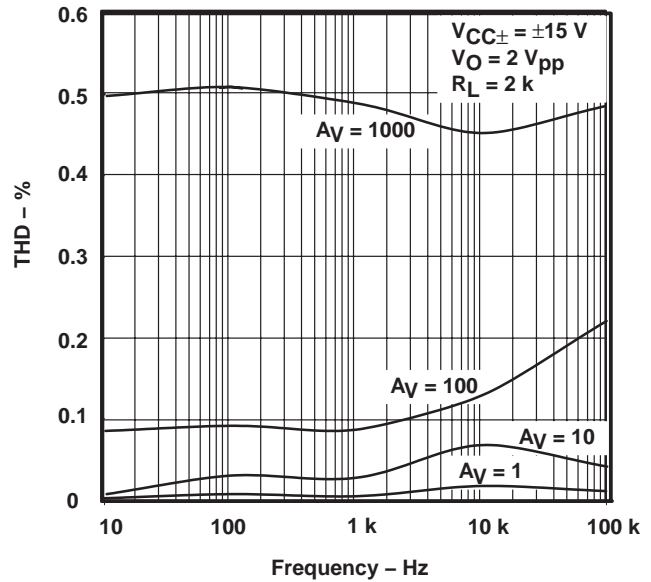

Figure 2

**GAIN AND PHASE
VS
FREQUENCY**

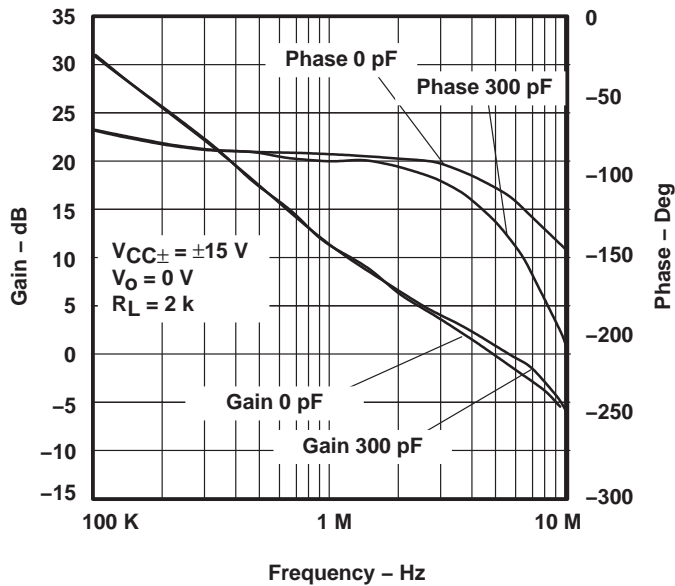

Figure 3

**NORMALIZED INPUT BIAS CURRENT
VS
TEMPERATURE**

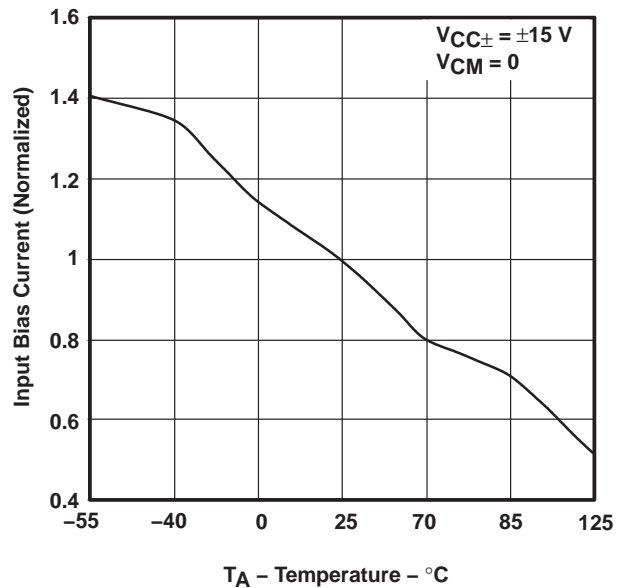

Figure 4



TYPICAL CHARACTERISTICS ($T_A = 25^\circ\text{C}$ UNLESS OTHERWISE NOTED)

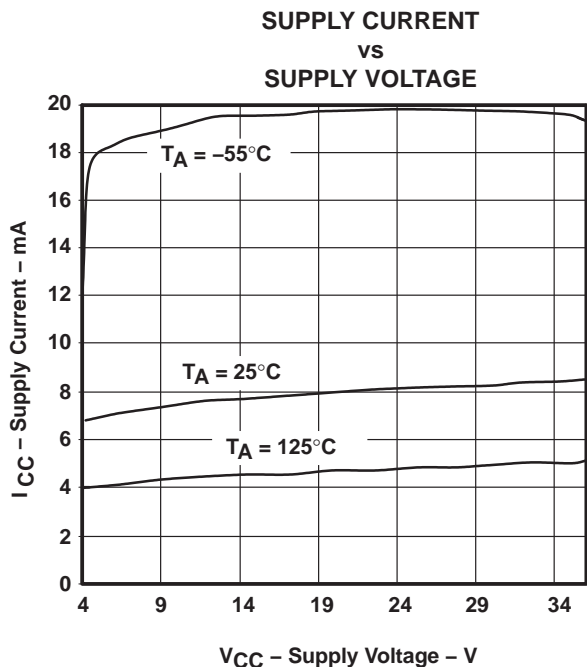

Figure 5

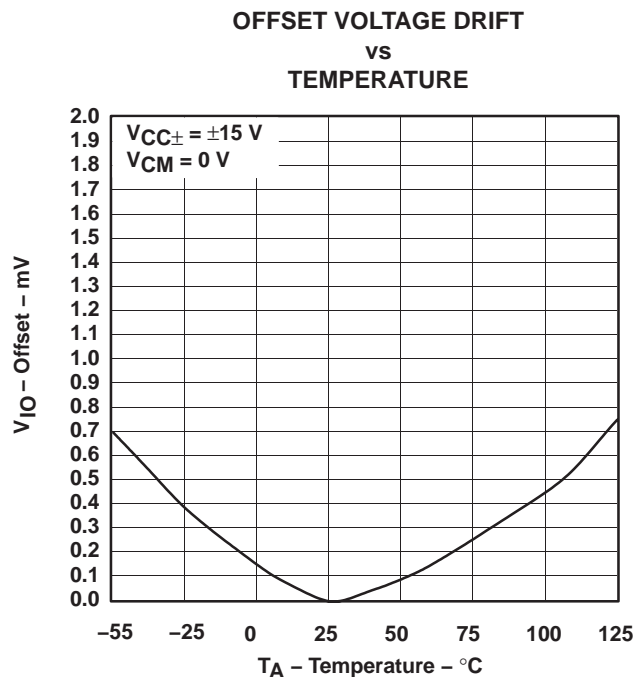

Figure 6

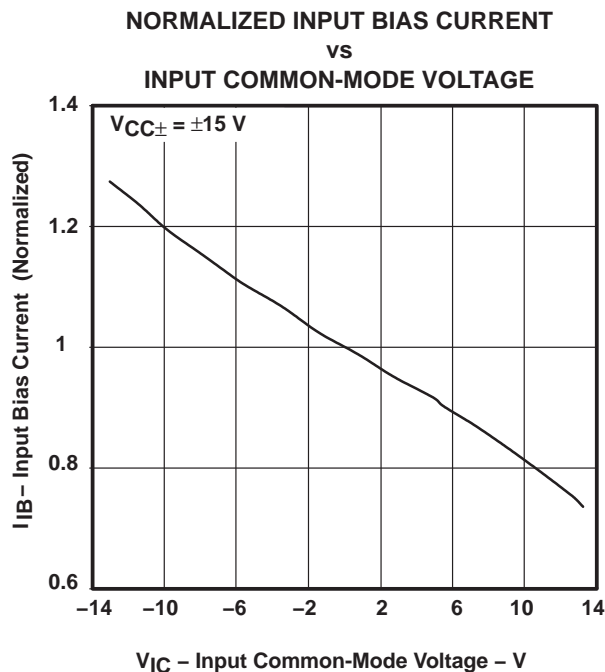

Figure 7

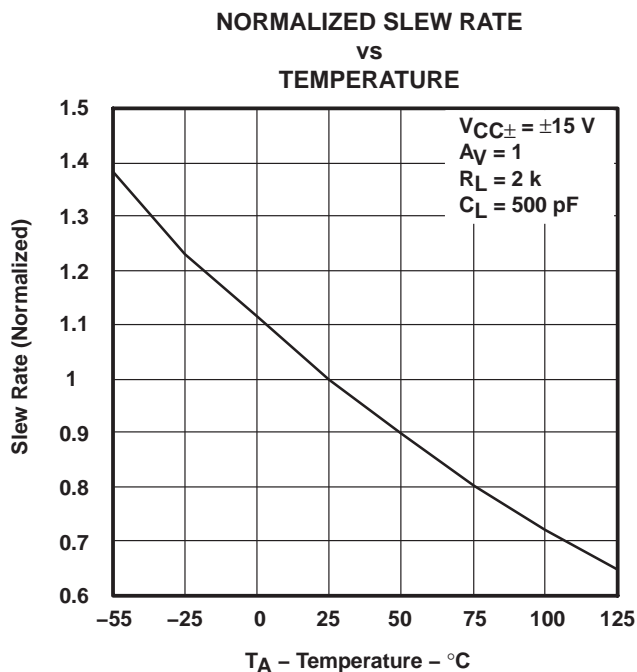

Figure 8

TL3474, TL3474A HIGH-SLEW-RATE, SINGLE-SUPPLY OPERATIONAL AMPLIFIERS

SLVS461B – JANUARY 2003 – REVISED JULY 2003

TYPICAL CHARACTERISTICS ($T_A = 25^\circ\text{C}$ UNLESS OTHERWISE NOTED)

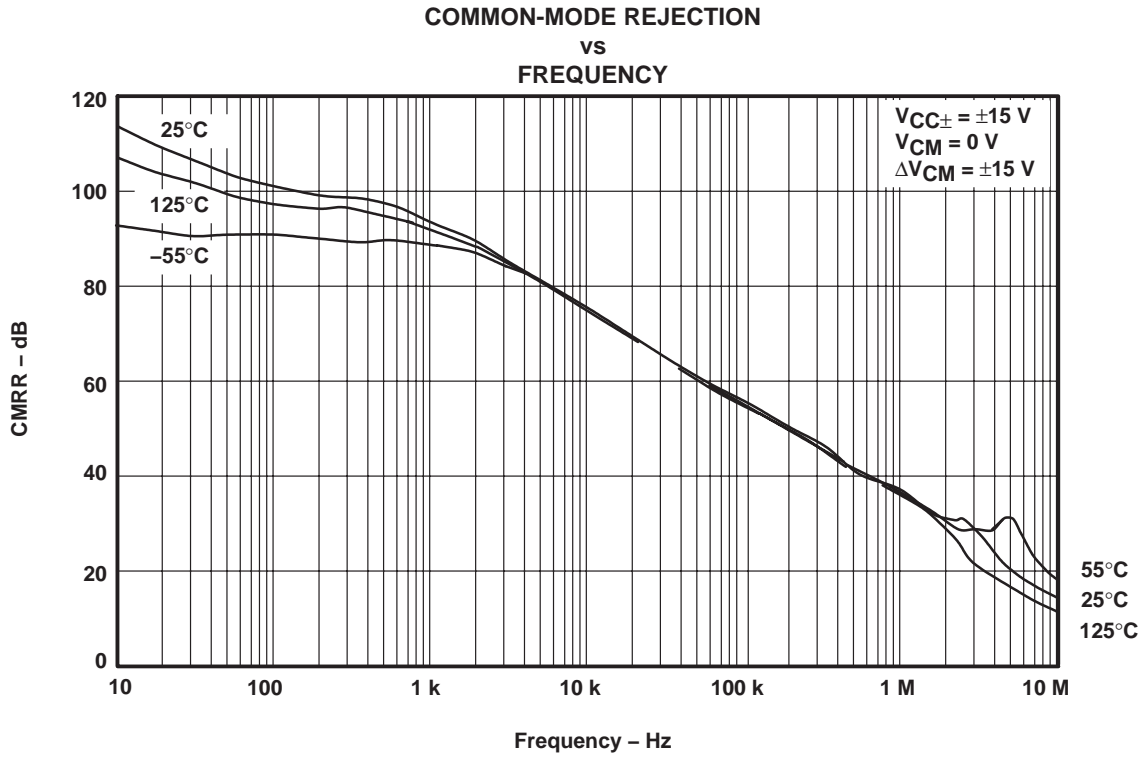

Figure 9

PACKAGING INFORMATION

Orderable Device	Status (1)	Package Type	Package Drawing	Pins	Package Qty	Eco Plan (2)	Lead finish/ Ball material (6)	MSL Peak Temp (3)	Op Temp (°C)	Device Marking (4/5)	Samples
TL3474ACD	ACTIVE	SOIC	D	14	50	RoHS & Green	NIPDAU	Level-1-260C-UNLIM	0 to 70	TL3474A	Samples
TL3474ACDR	ACTIVE	SOIC	D	14	2500	RoHS & Green	NIPDAU	Level-1-260C-UNLIM	0 to 70	TL3474A	Samples
TL3474ACN	ACTIVE	PDIP	N	14	25	RoHS & Green	NIPDAU	N / A for Pkg Type	0 to 70	TL3474ACN	Samples
TL3474ACPW	ACTIVE	TSSOP	PW	14	90	RoHS & Green	NIPDAU	Level-1-260C-UNLIM	0 to 70	T3474A	Samples
TL3474ACPWR	ACTIVE	TSSOP	PW	14	2000	RoHS & Green	NIPDAU	Level-1-260C-UNLIM	0 to 70	T3474A	Samples
TL3474AID	ACTIVE	SOIC	D	14	50	RoHS & Green	NIPDAU	Level-1-260C-UNLIM	-40 to 105	TL3474AI	Samples
TL3474AIDR	ACTIVE	SOIC	D	14	2500	RoHS & Green	NIPDAU	Level-1-260C-UNLIM	-40 to 105	TL3474AI	Samples
TL3474AIN	ACTIVE	PDIP	N	14	25	RoHS & Green	NIPDAU	N / A for Pkg Type	-40 to 105	TL3474AIN	Samples
TL3474AIPW	ACTIVE	TSSOP	PW	14	90	RoHS & Green	NIPDAU	Level-1-260C-UNLIM	-40 to 105	Z3474A	Samples
TL3474AIPWR	ACTIVE	TSSOP	PW	14	2000	RoHS & Green	NIPDAU	Level-1-260C-UNLIM	-40 to 105	Z3474A	Samples
TL3474CD	ACTIVE	SOIC	D	14	50	RoHS & Green	NIPDAU	Level-1-260C-UNLIM	0 to 70	TL3474C	Samples
TL3474CDR	ACTIVE	SOIC	D	14	2500	RoHS & Green	NIPDAU	Level-1-260C-UNLIM	0 to 70	TL3474C	Samples
TL3474CN	ACTIVE	PDIP	N	14	25	RoHS & Green	NIPDAU	N / A for Pkg Type	0 to 70	TL3474CN	Samples
TL3474CPW	ACTIVE	TSSOP	PW	14	90	RoHS & Green	NIPDAU	Level-1-260C-UNLIM	0 to 70	T3474	Samples
TL3474CPWR	ACTIVE	TSSOP	PW	14	2000	RoHS & Green	NIPDAU	Level-1-260C-UNLIM	0 to 70	T3474	Samples
TL3474ID	ACTIVE	SOIC	D	14	50	RoHS & Green	NIPDAU	Level-1-260C-UNLIM	-40 to 105	TL3474I	Samples
TL3474IDR	ACTIVE	SOIC	D	14	2500	RoHS & Green	NIPDAU	Level-1-260C-UNLIM	-40 to 105	TL3474I	Samples
TL3474IN	ACTIVE	PDIP	N	14	25	RoHS & Green	NIPDAU	N / A for Pkg Type	-40 to 105	TL3474IN	Samples
TL3474IPW	ACTIVE	TSSOP	PW	14	90	RoHS & Green	NIPDAU	Level-1-260C-UNLIM	-40 to 105	Z3474	Samples
TL3474IPWR	ACTIVE	TSSOP	PW	14	2000	RoHS & Green	NIPDAU	Level-1-260C-UNLIM	-40 to 105	Z3474	Samples

(1) The marketing status values are defined as follows:

ACTIVE: Product device recommended for new designs.

LIFEBUY: TI has announced that the device will be discontinued, and a lifetime-buy period is in effect.

NRND: Not recommended for new designs. Device is in production to support existing customers, but TI does not recommend using this part in a new design.

PREVIEW: Device has been announced but is not in production. Samples may or may not be available.

OBSOLETE: TI has discontinued the production of the device.

(2) **RoHS:** TI defines "RoHS" to mean semiconductor products that are compliant with the current EU RoHS requirements for all 10 RoHS substances, including the requirement that RoHS substance do not exceed 0.1% by weight in homogeneous materials. Where designed to be soldered at high temperatures, "RoHS" products are suitable for use in specified lead-free processes. TI may reference these types of products as "Pb-Free".

RoHS Exempt: TI defines "RoHS Exempt" to mean products that contain lead but are compliant with EU RoHS pursuant to a specific EU RoHS exemption.

Green: TI defines "Green" to mean the content of Chlorine (Cl) and Bromine (Br) based flame retardants meet JS709B low halogen requirements of ≤ 1000 ppm threshold. Antimony trioxide based flame retardants must also meet the ≤ 1000 ppm threshold requirement.

(3) MSL, Peak Temp. - The Moisture Sensitivity Level rating according to the JEDEC industry standard classifications, and peak solder temperature.

(4) There may be additional marking, which relates to the logo, the lot trace code information, or the environmental category on the device.

(5) Multiple Device Markings will be inside parentheses. Only one Device Marking contained in parentheses and separated by a "~" will appear on a device. If a line is indented then it is a continuation of the previous line and the two combined represent the entire Device Marking for that device.

(6) Lead finish/Ball material - Orderable Devices may have multiple material finish options. Finish options are separated by a vertical ruled line. Lead finish/Ball material values may wrap to two lines if the finish value exceeds the maximum column width.

Important Information and Disclaimer: The information provided on this page represents TI's knowledge and belief as of the date that it is provided. TI bases its knowledge and belief on information provided by third parties, and makes no representation or warranty as to the accuracy of such information. Efforts are underway to better integrate information from third parties. TI has taken and continues to take reasonable steps to provide representative and accurate information but may not have conducted destructive testing or chemical analysis on incoming materials and chemicals. TI and TI suppliers consider certain information to be proprietary, and thus CAS numbers and other limited information may not be available for release.

In no event shall TI's liability arising out of such information exceed the total purchase price of the TI part(s) at issue in this document sold by TI to Customer on an annual basis.

TAPE AND REEL INFORMATION

QUADRANT ASSIGNMENTS FOR PIN 1 ORIENTATION IN TAPE



*All dimensions are nominal

Device	Package Type	Package Drawing	Pins	SPQ	Reel Diameter (mm)	Reel Width W1 (mm)	A0 (mm)	B0 (mm)	K0 (mm)	P1 (mm)	W (mm)	Pin1 Quadrant
TL3474ACDR	SOIC	D	14	2500	330.0	16.4	6.5	9.0	2.1	8.0	16.0	Q1
TL3474ACPWR	TSSOP	PW	14	2000	330.0	12.4	6.9	5.6	1.6	8.0	12.0	Q1
TL3474AIDR	SOIC	D	14	2500	330.0	16.4	6.5	9.0	2.1	8.0	16.0	Q1
TL3474AIPWR	TSSOP	PW	14	2000	330.0	12.4	6.9	5.6	1.6	8.0	12.0	Q1
TL3474CDR	SOIC	D	14	2500	330.0	16.4	6.5	9.0	2.1	8.0	16.0	Q1
TL3474CPWR	TSSOP	PW	14	2000	330.0	12.4	6.9	5.6	1.6	8.0	12.0	Q1
TL3474IDR	SOIC	D	14	2500	330.0	16.4	6.5	9.0	2.1	8.0	16.0	Q1
TL3474IPWR	TSSOP	PW	14	2000	330.0	12.4	6.9	5.6	1.6	8.0	12.0	Q1

TAPE AND REEL BOX DIMENSIONS

*All dimensions are nominal

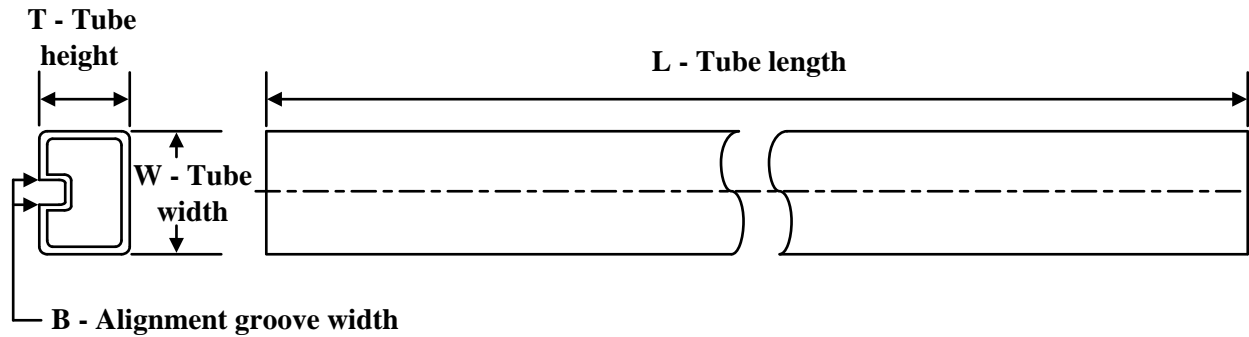
Device	Package Type	Package Drawing	Pins	SPQ	Length (mm)	Width (mm)	Height (mm)
TL3474ACDR	SOIC	D	14	2500	340.5	336.1	32.0
TL3474ACPWR	TSSOP	PW	14	2000	367.0	367.0	35.0
TL3474AIDR	SOIC	D	14	2500	340.5	336.1	32.0
TL3474AIPWR	TSSOP	PW	14	2000	356.0	356.0	35.0
TL3474CDR	SOIC	D	14	2500	340.5	336.1	32.0
TL3474CPWR	TSSOP	PW	14	2000	356.0	356.0	35.0
TL3474IDR	SOIC	D	14	2500	340.5	336.1	32.0
TL3474IPWR	TSSOP	PW	14	2000	356.0	356.0	35.0

TUBE

*All dimensions are nominal

Device	Package Name	Package Type	Pins	SPQ	L (mm)	W (mm)	T (μm)	B (mm)
TL3474ACD	D	SOIC	14	50	507	8	3940	4.32
TL3474ACN	N	PDIP	14	25	506	13.97	11230	4.32
TL3474ACPW	PW	TSSOP	14	90	530	10.2	3600	3.5
TL3474AID	D	SOIC	14	50	507	8	3940	4.32
TL3474AIN	N	PDIP	14	25	506	13.97	11230	4.32
TL3474AIPW	PW	TSSOP	14	90	530	10.2	3600	3.5
TL3474CD	D	SOIC	14	50	507	8	3940	4.32
TL3474CN	N	PDIP	14	25	506	13.97	11230	4.32
TL3474CPW	PW	TSSOP	14	90	530	10.2	3600	3.5
TL3474ID	D	SOIC	14	50	507	8	3940	4.32
TL3474IN	N	PDIP	14	25	506	13.97	11230	4.32
TL3474IPW	PW	TSSOP	14	90	530	10.2	3600	3.5

D (R-PDSO-G14)

PLASTIC SMALL OUTLINE



- NOTES:
- A. All linear dimensions are in inches (millimeters).
 - B. This drawing is subject to change without notice.
 - Body length does not include mold flash, protrusions, or gate burrs. Mold flash, protrusions, or gate burrs shall not exceed 0.006 (0,15) each side.
 - Body width does not include interlead flash. Interlead flash shall not exceed 0.017 (0,43) each side.
 - E. Reference JEDEC MS-012 variation AB.

PW (R-PDSO-G14)

PLASTIC SMALL OUTLINE



4040064-3/G 02/11

- NOTES:
- A. All linear dimensions are in millimeters. Dimensioning and tolerancing per ASME Y14.5M-1994.
 - B. This drawing is subject to change without notice.
 -  C. Body length does not include mold flash, protrusions, or gate burrs. Mold flash, protrusions, or gate burrs shall not exceed 0,15 each side.
 -  D. Body width does not include interlead flash. Interlead flash shall not exceed 0,25 each side.
 - E. Falls within JEDEC MO-153

PW (R-PDSO-G14)

PLASTIC SMALL OUTLINE



4211284-2/G 08/15

- NOTES:
- All linear dimensions are in millimeters.
 - This drawing is subject to change without notice.
 - Publication IPC-7351 is recommended for alternate designs.
 - Laser cutting apertures with trapezoidal walls and also rounding corners will offer better paste release. Customers should contact their board assembly site for stencil design recommendations. Refer to IPC-7525 for other stencil recommendations.
 - Customers should contact their board fabrication site for solder mask tolerances between and around signal pads.

N (R-PDIP-T**)

PLASTIC DUAL-IN-LINE PACKAGE

16 PINS SHOWN



- NOTES:
- A. All linear dimensions are in inches (millimeters).
 - B. This drawing is subject to change without notice.
 - Falls within JEDEC MS-001, except 18 and 20 pin minimum body length (Dim A).
 - The 20 pin end lead shoulder width is a vendor option, either half or full width.

IMPORTANT NOTICE AND DISCLAIMER

TI PROVIDES TECHNICAL AND RELIABILITY DATA (INCLUDING DATA SHEETS), DESIGN RESOURCES (INCLUDING REFERENCE DESIGNS), APPLICATION OR OTHER DESIGN ADVICE, WEB TOOLS, SAFETY INFORMATION, AND OTHER RESOURCES "AS IS" AND WITH ALL FAULTS, AND DISCLAIMS ALL WARRANTIES, EXPRESS AND IMPLIED, INCLUDING WITHOUT LIMITATION ANY IMPLIED WARRANTIES OF MERCHANTABILITY, FITNESS FOR A PARTICULAR PURPOSE OR NON-INFRINGEMENT OF THIRD PARTY INTELLECTUAL PROPERTY RIGHTS.

These resources are intended for skilled developers designing with TI products. You are solely responsible for (1) selecting the appropriate TI products for your application, (2) designing, validating and testing your application, and (3) ensuring your application meets applicable standards, and any other safety, security, regulatory or other requirements.

These resources are subject to change without notice. TI grants you permission to use these resources only for development of an application that uses the TI products described in the resource. Other reproduction and display of these resources is prohibited. No license is granted to any other TI intellectual property right or to any third party intellectual property right. TI disclaims responsibility for, and you will fully indemnify TI and its representatives against, any claims, damages, costs, losses, and liabilities arising out of your use of these resources.

TI's products are provided subject to [TI's Terms of Sale](#) or other applicable terms available either on [ti.com](https://www.ti.com) or provided in conjunction with such TI products. TI's provision of these resources does not expand or otherwise alter TI's applicable warranties or warranty disclaimers for TI products.

TI objects to and rejects any additional or different terms you may have proposed.

Mailing Address: Texas Instruments, Post Office Box 655303, Dallas, Texas 75265
Copyright © 2023, Texas Instruments Incorporated

X-ON Electronics

Largest Supplier of Electrical and Electronic Components

Click to view similar products for [Operational Amplifiers - Op Amps](#) category:

Click to view products by [Texas Instruments](#) manufacturer:

Other Similar products are found below :

[430227FB](#) [LT1678IS8](#) [NCV33202DMR2G](#) [NJM324E](#) [M38510/13101BPA](#) [NTE925](#) [AZV358MTR-G1](#) [AP4310AUMTR-AG1](#)
[AZV358MMTR-G1](#) [SCY33178DR2G](#) [NCV20034DR2G](#) [NTE778S](#) [NTE871](#) [NTE937](#) [NJU7057RB1-TE2](#) [SCY6358ADR2G](#)
[NJM2904CRB1-TE1](#) [UPC4570G2-E1-A](#) [UPC4741G2-E1-A](#) [NJM8532RB1-TE1](#) [EL2250CS](#) [EL5100IS](#) [EL5104IS](#) [EL5127CY](#) [EL5127CZY](#)
[EL5133IW](#) [EL5152IS](#) [EL5156IS](#) [EL5162IS](#) [EL5202IY](#) [EL5203IY](#) [EL5204IY](#) [EL5210CS](#) [EL5210CZY](#) [EL5211IYE](#) [EL5220CY](#)
[EL5223CLZ](#) [EL5223CR](#) [EL5224ILZ](#) [EL5227CLZ](#) [EL5227CRZ](#) [EL5244CS](#) [EL5246CS](#) [EL5246CSZ](#) [EL5250IY](#) [EL5251IS](#) [EL5257IS](#)
[EL5260IY](#) [EL5261IS](#) [EL5300IU](#)