

# TLE206x, TLE206xA, TLE206xB EXCALIBUR JFET-INPUT HIGH-OUTPUT-DRIVE $\mu$ POWER OPERATIONAL AMPLIFIERS

SLOS193B – FEBRUARY 1997 – REVISED MAY 2004

- **2 $\times$  Bandwidth (2 MHz) of the TL06x and TL03x Operational Amplifiers**
- **Low Supply Current . . . 290  $\mu$ A/Ch Typ**
- **On-chip Offset Voltage Trimming for Improved DC Performance**
- **High Output Drive, Specified into 100- $\Omega$  Loads**
- **Lower Noise Floor Than Earlier Generations of Low-Power BiFETs**

## description

The TLE206x series of low-power JFET-input operational amplifiers doubles the bandwidth of the earlier generation TL06x and TL03x BiFET families without significantly increasing power consumption. Texas Instruments Excalibur process also delivers a lower noise floor than the TL06x and TL03x. On-chip zener trimming of offset voltage yields precision grades for dc-coupled applications. The TL206x devices are pin-compatible with other Texas Instruments BiFETs; they can be used to double the bandwidth of TL06x and TL03x circuits or to reduce power consumption of TL05x, TL07x, and TL08x circuits by nearly 90%.

BiFET operational amplifiers offer the inherently-higher input impedance of the JFET-input transistors, without sacrificing the output drive associated with bipolar amplifiers. This makes them better suited for interfacing with high-impedance sensors or low-level ac signals. They also feature inherently better ac response than bipolar or CMOS devices having comparable power consumption. The TLE206x family features a high-output-drive circuit capable of driving 100- $\Omega$  loads at supplies as low as  $\pm 5$  V. This makes them uniquely suited for driving transformer loads in modems and other applications requiring good ac characteristics, low power, and high output drive.

Because BiFET operational amplifiers are designed for use with dual power supplies, care must be taken to observe common-mode input voltage limits and output swing when operating from a single supply. DC biasing of the input signal is required and loads should be terminated to a virtual ground node at mid-supply. Texas Instruments TLE2426 integrated virtual ground generator is useful when operating BiFET amplifiers from single supplies.

The TLE206x are fully specified at  $\pm 15$  V and  $\pm 5$  V. For operation in low-voltage and/or single-supply systems, Texas Instruments LinCMOS families of operational amplifiers (TLC- and TLV-prefixes) are recommended. When moving from BiFET to CMOS amplifiers, particular attention should be paid to slew rate and bandwidth requirements and output loading. The Texas Instruments TLV2432 and TLV2442 CMOS operational amplifiers are excellent choices to consider.



Please be aware that an important notice concerning availability, standard warranty, and use in critical applications of Texas Instruments semiconductor products and disclaimers thereto appears at the end of this data sheet.

**PRODUCTION DATA** information is current as of publication date. Products conform to specifications per the terms of Texas Instruments standard warranty. Production processing does not necessarily include testing of all parameters.



POST OFFICE BOX 655303 • DALLAS, TEXAS 75265

Copyright © 2004, Texas Instruments Incorporated

# TLE206x, TLE206xA, TLE206xB EXCALIBUR JFET-INPUT HIGH-OUTPUT-DRIVE μPOWER OPERATIONAL AMPLIFIERS

SLOS193B – FEBRUARY 1997 – REVISED MAY 2004

## TLE2061 AVAILABLE OPTIONS

PACKAGED DEVICES							
T <sub>A</sub>	V <sub>IO</sub> max AT 25°C	SMALL OUTLINE† (D)	CHIP CARRIER (FK)	CERAMIC DIP (JG)	PLASTIC DIP (P)	TSSOP‡ (PW)	CERAMIC FLAT PACK (U)
0°C to 70°C	500 μV	—	—	—	—	—	—
	1.5 mV	TLE2061ACD	—	—	TLE2061ACP	—	—
	3 mV	TLE2061CD	—	—	TLE2061CP	TLE2061CPWLE	—
–40°C to 85°C	500 μV	—	—	—	—	—	—
	1.5 mV	TLE2061AID	—	—	TLE2061AIP	—	—
	3 mV	TLE2061ID	—	—	TLE2061IP	—	—
–55°C to 125°C	500 μV	—	—	TLE2061BMJG	—	—	—
	1.5 mV	TLE2061AMD	TLE2061AMFK	TLE2061AMJG	—	—	TLE2061AMU
	3 mV	TLE2061MD	TLE2061MFK	TLE2061MJG	—	—	TLE2061MU

† The D packages are available taped and reeled. Add R suffix to device type (e.g., TLE2061ACDR). Chips are tested at 25°C.

‡ The PW package is available left-end taped and reeled (indicated by the LE suffix on the device type (e.g., TLE2061CPWLE)).

## TLE2062 AVAILABLE OPTIONS

PACKAGED DEVICES						
T <sub>A</sub>	V <sub>IO</sub> max AT 25°C	SMALL OUTLINE† (D)	CHIP CARRIER (FK)	CERAMIC DIP (JG)	PLASTIC DIP (P)	CERAMIC FLAT PACK (U)
0°C to 70°C	1 mV	TLE2062BCD	—	—	TLE2062BCP	—
	2 mV	TLE2062ACD	—	—	TLE2062ACP	—
	4 mV	TLE2062CD	—	—	TLE2062CP	—
–40°C to 85°C	1 mV	TLE2062BID	—	—	TLE2062BIP	—
	2 mV	TLE2062AID	—	—	TLE2062AIP	—
	4 mV	TLE2062ID	—	—	TLE2062IP	—
–55°C to 125°C	1 mV	TLE2062BMD	—	TLE2062BMJG	—	—
	2 mV	TLE2062AMD	TLE2062AMFK	TLE2062AMJG	—	TLE2062AMU
	4 mV	TLE2062MD	TLE2062MFK	TLE2062MJG	—	TLE2062MU

† The D packages are available taped and reeled. Add R suffix to device type (e.g., TLE2062ACDR).

## TLE2064 AVAILABLE OPTIONS

PACKAGED DEVICES						
T <sub>A</sub>	V <sub>IO</sub> max AT 25°C	SMALL OUTLINE† (D)	CHIP CARRIER (FK)	CERAMIC DIP (J)	PLASTIC DIP (N)	CERAMIC FLAT PACK (W)
0°C to 70°C	2 mV	—	—	—	TLE2064BCN	—
	4 mV	TLE2064ACD	—	—	TLE2064ACN	—
	6 mV	TLE2064CD	—	—	TLE2064CN	—
–40°C to 85°C	2 mV	—	—	—	TLE2064BIN	—
	4 mV	TLE2064AID	—	—	TLE2064AIN	—
	6 mV	TLE2064ID	—	—	TLE2064IN	—
–55°C to 125°C	2 mV	—	TLE2064BMFK	TLE2064BMJ	—	—
	4 mV	TLE2064AMD	TLE2064AMFK	TLE2064AMJ	—	TLE2064AMW
	6 mV	TLE2064MD	TLE2064MFK	TLE2064MJ	—	TLE2064MW

† The D packages are available taped and reeled. Add R suffix to device type, (e.g., TLE2064ACDR).



# TLE206x, TLE206xA, TLE206xB EXCALIBUR JFET-INPUT HIGH-OUTPUT-DRIVE μPOWER OPERATIONAL AMPLIFIERS

SLOS193B – FEBRUARY 1997 – REVISED MAY 2004

**TLE2061, TLE2061A, AND TLE2061B**  
D, DB, JG, P, OR PW PACKAGE  
(TOP VIEW)

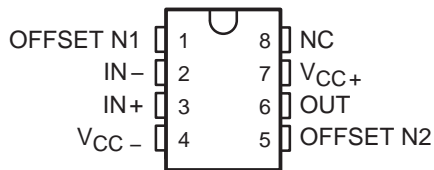

**TLE2062, TLE2062A, TLE2062B**  
D, JG, OR P PACKAGE  
(TOP VIEW)

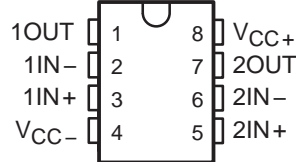

**TLE2064, TLE2064A, TLE2064B**  
D, J, N, OR W PACKAGE  
(TOP VIEW)

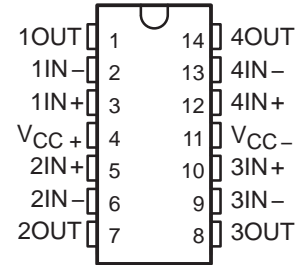

**TLE2061M, TLE2061AM, TLE2061BM**  
FK PACKAGE  
(TOP VIEW)



**TLE2062M, TLE2062AM, TLE2062BM**  
FK PACKAGE  
(TOP VIEW)

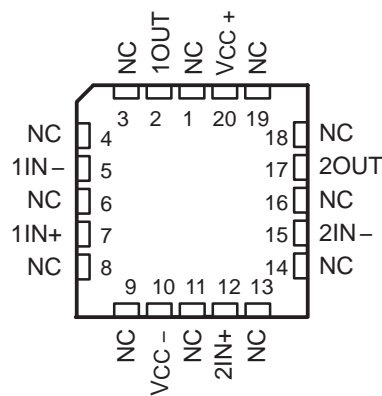

**TLE2064M, TLE2064AM, TLE2064BM**  
FK PACKAGE  
(TOP VIEW)

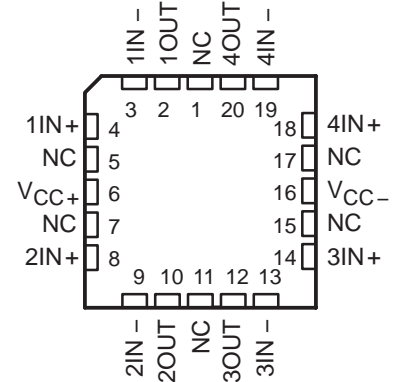

**TLE2061 AND TLE2061A**  
U PACKAGE  
(TOP VIEW)



**TLE2062 AND TLE2062A**  
U PACKAGE  
(TOP VIEW)



NC – No internal connection

# TLE206x, TLE206xA, TLE206xB EXCALIBUR JFET-INPUT HIGH-OUTPUT-DRIVE POWER OPERATIONAL AMPLIFIERS

SLOS193B – FEBRUARY 1997 – REVISED APRIL 2004

equivalent schematic (each channel)

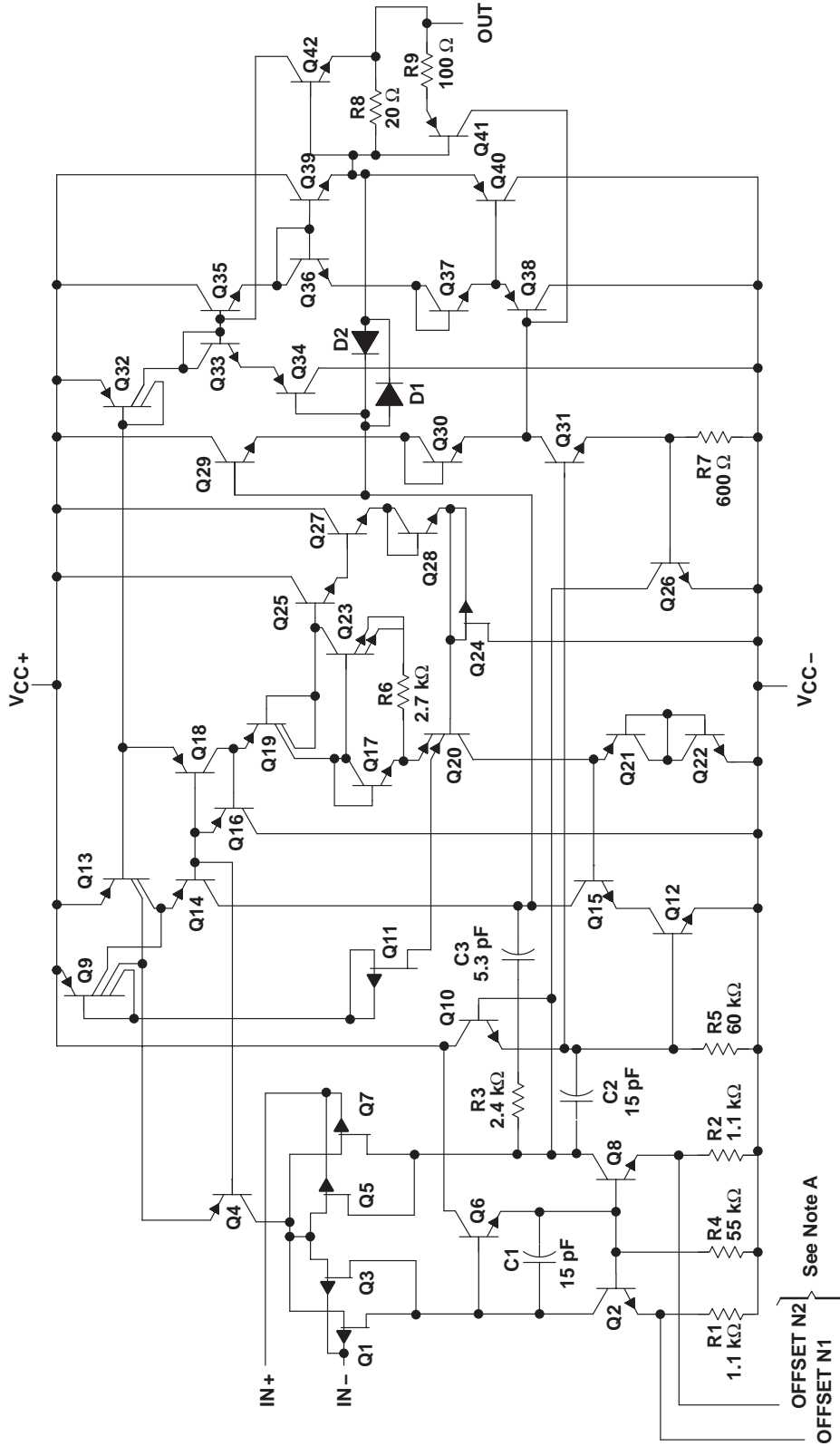

NOTES: A. OFFSET N1 AND OFFSET N2 are only available on the TLE2061x devices.  
B. Component values are nominal.

COMPONENT	ACTUAL DEVICE COMPONENT COUNT		
	TLE2061	TLE2062	TLE2064
Transistors	43	42	42
Resistors	9	9	9
Diodes	1	2	2
Capacitors	3	3	3

**absolute maximum ratings over operating free-air temperature range (unless otherwise noted)†**

Supply voltage, $V_{CC+}$ (see Note 1)	19 V	
Supply voltage, $V_{CC-}$	–19 V	
Differential input voltage, $V_{ID}$ (see Note 2)	±38 V	
Input voltage range, $V_I$ (any input)	± $V_{CC}$	
Input current, $I_I$ (each input)	±1 mA	
Output current, $I_O$	±80 mA	
Total current into $V_{CC+}$	80 mA	
Total current out of $V_{CC-}$	–80 mA	
Duration of short-circuit current at (or below) 25°C (see Note 3)	unlimited	
Package thermal impedance, $\theta_{JA}$ (see Notes 4 and 5):	D package (8-pin)	97.1°C/W
	D package (14-pin)	86.2°C/W
	N package	79.7°C/W
	P package	84.6°C/W
	PW package	113°C/W
Package thermal impedance, $\theta_{JC}$ (see Notes 4 and 5):	FK package	5.6°C/W
	J package	15.1°C/W
	JG package	14.5°C/W
	U package	14.7°C/W
	W package	10°C/W
Operating free-air temperature range, $T_A$ :	C suffix	0°C to 70°C
	I suffix	–40°C to 85°C
	M suffix	–55°C to 125°C
Storage temperature range	–65°C to 150°C	
Case temperature for 60 seconds: FK package	260°C	
Lead temperature 1,6 mm (1/16 inch) from case for 10 seconds: D, P, or PW package	260°C	
Lead temperature 1,6 mm (1/16 inch) from case for 60 seconds: JG, U, or W package	300°C	

† Stresses beyond those listed under “absolute maximum ratings” may cause permanent damage to the device. These are stress ratings only, and functional operation of the device at these or any other conditions beyond those indicated under “recommended operating conditions” is not implied. Exposure to absolute-maximum-rated conditions for extended periods may affect device reliability.

- NOTES:
1. All voltage values, except differential voltages, are with respect to the midpoint between  $V_{CC+}$  and  $V_{CC-}$ .
  2. Differential voltages are at  $IN+$  with respect to  $IN-$ .
  3. The output may be shorted to either supply. Temperature and/or supply voltages must be limited to ensure that the maximum dissipation rating is not exceeded.
  4. Maximum power dissipation is a function of  $T_J(\text{max})$ ,  $\theta_{JA}$ , and  $T_A$ . The maximum allowable power dissipation at any allowable ambient temperature is  $P_D = (T_J(\text{max}) - T_A)/\theta_{JA}$ . Operating at the absolute maximum  $T_J$  of 150°C can affect reliability.
  5. The package thermal impedance is calculated in accordance with JESD 51-7 (plastic) or MIL-STD-883 Method 1012 (ceramic).

**recommended operating conditions**

	C SUFFIX		I SUFFIX		M SUFFIX		UNIT
	MIN	MAX	MIN	MAX	MIN	MAX	
Supply voltage, $V_{CC\pm}$	±3.5	±18	±3.5	±18	±3.5	±18	V
Common-mode input voltage, $V_{IC}$	$V_{CC\pm} = \pm 5$ V		–1.6	4	–1.6	4	V
	$V_{CC\pm} = \pm 15$ V		–11	13	–11	13	
Operating free-air temperature, $T_A$	0	70	–40	85	–55	125	°C

**TLE206x, TLE206xA, TLE206xB**  
**EXCALIBUR JFET-INPUT HIGH-OUTPUT-DRIVE**  
**μPOWER OPERATIONAL AMPLIFIERS**

SLOS193B – FEBRUARY 1997 – REVISED MAY 2004

**TLE2061C electrical characteristics at specified free-air temperature,  $V_{CC\pm} = \pm 5\text{ V}$  (unless otherwise noted)**

PARAMETER		TEST CONDITIONS	$T_A$ †	TLE2061C TLE2061AC TLE2061BC			UNIT
				MIN	TYP	MAX	
$V_{IO}$ Input offset voltage	TLE2061C	$V_{IC} = 0, R_S = 50\ \Omega$	25°C	0.8	3.1	mV	
			Full range	4			
	TLE2061AC		25°C	0.6	2.6		
			Full range	3.5			
	TLE2061BC		25°C	0.5	1.9		
			Full range	2.4			
$\alpha_{VIO}$ Temperature coefficient of input offset voltage		Full range	6		$\mu\text{V}/^\circ\text{C}$		
Input offset voltage long-term drift (see Note 4)			25°C	0.04		$\mu\text{V}/\text{mo}$	
$I_{IO}$ Input offset current			25°C	1		pA	
			Full range	0.8		nA	
$I_{IB}$ Input bias current			25°C	3		pA	
			Full range	2		nA	
$V_{ICR}$ Common-mode input voltage range			25°C	-1.6 to 4	-2 to 6	V	
			Full range	-1.6 to 4		V	
$V_{OM+}$ Maximum positive peak output voltage swing	$R_L = 10\ \text{k}\Omega$		25°C	3.5	3.7	V	
			Full range	3.3			
	$R_L = 100\ \Omega$		25°C	2.5	3.1		
			Full range	2			
$V_{OM-}$ Maximum negative peak output voltage swing	$R_L = 10\ \text{k}\Omega$		25°C	-3.7	-3.9	V	
			Full range	-3.3			
	$R_L = 100\ \Omega$		25°C	-2.5	-2.7		
			Full range	-2			
$A_{VD}$ Large-signal differential voltage amplification	$V_O = \pm 2.8\ \text{V}, R_L = 10\ \text{k}\Omega$		25°C	15	80	V/mV	
			Full range	2			
	$V_O = 0\ \text{to}\ 2\ \text{V}, R_L = 100\ \Omega$		25°C	0.75	45		
			Full range	0.5			
	$V_O = 0\ \text{to}\ -2\ \text{V}, R_L = 100\ \Omega$		25°C	0.5	3		
			Full range	0.25			
$r_i$ Input resistance			25°C	$10^{12}$		$\Omega$	
$c_i$ Input capacitance			25°C	4		pF	
$z_o$ Open-loop output impedance	$I_O = 0$		25°C	280		$\Omega$	
CMRR Common-mode rejection ratio	$V_{IC} = V_{ICR\text{min}}, R_S = 50\ \Omega$		25°C	65	82	dB	
			Full range	65			
$k_{SVR}$ Supply-voltage rejection ratio ( $\Delta V_{CC\pm}/\Delta V_{IO}$ )	$V_{CC\pm} = \pm 5\ \text{V to } \pm 15\ \text{V}, R_S = 50\ \Omega$		25°C	75	93	dB	
			Full range	75			

† Full range is 0°C to 70°C.

NOTE 6: Typical values are based on the input offset voltage shift observed through 168 hours of operating life test at  $T_A = 150^\circ\text{C}$  extrapolated to  $T_A = 25^\circ\text{C}$  using the Arrhenius equation and assuming an activation energy of 0.96 eV.



**TLE206x, TLE206xA, TLE206xB**  
**EXCALIBUR JFET-INPUT HIGH-OUTPUT-DRIVE**  
**μPOWER OPERATIONAL AMPLIFIERS**

SLOS193B – FEBRUARY 1997 – REVISED MAY 2004

**TLE2061C electrical characteristics at specified free-air temperature,  $V_{CC\pm} = \pm 5\text{ V}$  (unless otherwise noted) (continued)**

PARAMETER	TEST CONDITIONS	$T_A$ †	TLE2061C TLE2061AC TLE2061BC			UNIT
			MIN	TYP	MAX	
$I_{CC}$ Supply current	$V_O = 0$ , No load	25°C		280	325	$\mu\text{A}$
		Full range			350	
$\Delta I_{CC}$ Supply-current change over operating temperature range		Full range		29		$\mu\text{A}$

† Full range is 0°C to 70°C.

**TLE2061C operating characteristics at specified free-air temperature,  $V_{CC\pm} = \pm 5\text{ V}$**

PARAMETER	TEST CONDITIONS	$T_A$ †	TLE2061C TLE2061AC TLE2061BC			UNIT
			MIN	TYP	MAX	
SR Slew rate at unity gain (see Figure 1)	$R_L = 10\text{ k}\Omega$ , $C_L = 100\text{ pF}$	25°C	2.2	3.4		$\text{V}/\mu\text{s}$
		Full range	2.1			
$V_n$ Equivalent input noise voltage (see Figure 2)	$f = 10\text{ Hz}$ , $R_S = 20\ \Omega$	25°C		59	100	$\text{nV}/\sqrt{\text{Hz}}$
	$f = 1\text{ kHz}$ , $R_S = 20\ \Omega$			43	60	
$V_{N(PP)}$ Peak-to-peak equivalent input noise voltage	$f = 0.1\text{ Hz}$ to $10\text{ Hz}$	25°C		1.1		$\mu\text{V}$
$I_n$ Equivalent input noise current	$f = 1\text{ kHz}$	25°C		1		$\text{fA}/\sqrt{\text{Hz}}$
THD Total harmonic distortion	$A_{VD} = 2$ , $f = 10\text{ kHz}$ , $V_{O(PP)} = 2\text{ V}$ , $R_L = 10\text{ k}\Omega$	25°C		0.025%		
$B_1$ Unity-gain bandwidth (see Figure 3)	$R_L = 10\text{ k}\Omega$ , $C_L = 100\text{ pF}$	25°C		1.8		MHz
	$R_L = 100\ \Omega$ , $C_L = 100\text{ pF}$			1.3		
$t_s$ Settling time	0.1%	25°C		5		$\mu\text{s}$
	0.01%			10		
$B_{OM}$ Maximum output-swing bandwidth	$A_{VD} = 1$ , $R_L = 10\text{ k}\Omega$	25°C		140		kHz
$\phi_m$ Phase margin at unity gain (see Figure 3)	$R_L = 10\text{ k}\Omega$ , $C_L = 100\text{ pF}$	25°C		58°		
	$R_L = 100\ \Omega$ , $C_L = 100\text{ pF}$			75°		

† Full range is 0°C to 70°C.

**TLE206x, TLE206xA, TLE206xB**  
**EXCALIBUR JFET-INPUT HIGH-OUTPUT-DRIVE**  
**μPOWER OPERATIONAL AMPLIFIERS**

SLOS193B – FEBRUARY 1997 – REVISED MAY 2004

**TLE2061C electrical characteristics at specified free-air temperature,  $V_{CC\pm} = \pm 15$  V (unless otherwise noted)**

PARAMETER		TEST CONDITIONS	$T_A$ †	TLE2061C TLE2061AC TLE2061BC			UNIT	
				MIN	TYP	MAX		
$V_{IO}$ Input offset voltage	TLE2061C	$V_{IC} = 0, R_S = 50 \text{ k}\Omega$	25°C	0.6	3	mV		
			Full range	3.9				
			25°C	0.5	1.5			
	TLE2061AC		Full range	2.5				
			TLE2061BC	25°C	0.3		0.5	
				Full range	1			
	$\alpha V_{IO}$ Temperature coefficient of input offset voltage			Full range	6		$\mu\text{V}/^\circ\text{C}$	
	Input offset voltage long-term drift (see Note 4)		25°C	0.04			$\mu\text{V}/\text{mo}$	
	$I_{IO}$ Input offset current			25°C	2		pA	
Full range		1		nA				
$I_{IB}$ Input bias current		25°C	4		pA			
		Full range	3		nA			
$V_{ICR}$ Common-mode input voltage range		25°C	-11 to 13	-12 to 16	V			
		Full range	-11 to 13		V			
$V_{OM+}$ Maximum positive peak output voltage swing	$R_L = 10 \text{ k}\Omega$	25°C	13.2	13.7	V			
		Full range	13					
	$R_L = 600 \Omega$	25°C	12.5	13.2				
		Full range	12					
$V_{OM-}$ Maximum negative peak output voltage swing	$R_L = 10 \text{ k}\Omega$	25°C	-13.2	-13.7	V			
		Full range	-13					
	$R_L = 600 \Omega$	25°C	-12.5	-13				
		Full range	-12					
$A_{VD}$ Large-signal differential voltage amplification	$V_O = \pm 10 \text{ V}, R_L = 10 \text{ k}\Omega$	25°C	30	230	V/mV			
		Full range	20					
	$V_O = 0 \text{ to } 8 \text{ V}, R_L = 600 \Omega$	25°C	25	100				
		Full range	10					
	$V_O = 0 \text{ to } -8 \text{ V}, R_L = 600 \Omega$	25°C	3	25				
		Full range	1					
$r_i$ Input resistance		25°C	10 <sup>12</sup>		$\Omega$			
$c_i$ Input capacitance		25°C	4		pF			
$z_o$ Open-loop output impedance	$I_O = 0$	25°C	280		$\Omega$			
CMRR Common-mode rejection ratio	$V_{IC} = V_{ICRmin}, R_S = 50 \Omega$	25°C	72	90	dB			
		Full range	70					
$k_{SVR}$ Supply-voltage rejection ratio ( $\Delta V_{CC\pm}/\Delta V_{IO}$ )	$V_{CC\pm} = \pm 5 \text{ V to } \pm 15 \text{ V}, R_S = 50 \Omega$	25°C	75	93	dB			
		Full range	75					

† Full range is 0°C to 70°C.

NOTE 4: Typical values are based on the input offset voltage shift observed through 168 hours of operating life test at  $T_A = 150^\circ\text{C}$  extrapolated to  $T_A = 25^\circ\text{C}$  using the Arrhenius equation and assuming an activation energy of 0.96 eV.





**TLE206x, TLE206xA, TLE206xB**  
**EXCALIBUR JFET-INPUT HIGH-OUTPUT-DRIVE**  
**μPOWER OPERATIONAL AMPLIFIERS**

SLOS193B – FEBRUARY 1997 – REVISED MAY 2004

**TLE2061C electrical characteristics at specified free-air temperature,  $V_{CC\pm} = \pm 15\text{ V}$  (unless otherwise noted) (continued)**

PARAMETER	TEST CONDITIONS	$T_A$ †	TLE2061C TLE2061AC TLE2061BC			UNIT
			MIN	TYP	MAX	
$I_{CC}$ Supply current	$V_O = 0$ , No load	25°C	290	350	μA	
		Full range	375			
$\Delta I_{CC}$ Supply-current change over operating temperature range		Full range	34		μA	

† Full range is 0°C to 70°C.

**TLE2061C operating characteristics at specified free-air temperature,  $V_{CC\pm} = \pm 15\text{ V}$**

PARAMETER	TEST CONDITIONS	$T_A$ †	TLE2061C TLE2061AC TLE2061BC			UNIT
			MIN	TYP	MAX	
SR Slew rate at unity gain (see Figure 1)	$R_L = 10\text{ k}\Omega$ , $C_L = 100\text{ pF}$	25°C	2.6	3.4	V/μs	
		Full range	2.5			
$V_n$ Equivalent input noise voltage (see Figure 2)	$f = 10\text{ Hz}$ , $R_S = 20\ \Omega$	25°C	70	100	nV/√Hz	
	$f = 1\text{ kHz}$ , $R_S = 20\ \Omega$		40	60		
$V_{N(PP)}$ Peak-to-peak equivalent input noise voltage	$f = 0.1\text{ Hz to }10\text{ Hz}$	25°C	1.1		μV	
$I_n$ Equivalent input noise current	$f = 1\text{ kHz}$	25°C	1.1		fA/√Hz	
THD Total harmonic distortion	$A_{VD} = 2$ , $V_{O(PP)} = 2\text{ V}$ , $f = 10\text{ kHz}$ , $R_L = 10\text{ k}\Omega$	25°C	0.025%			
$B_1$ Unity-gain bandwidth (see Figure 3)	$R_L = 10\text{ k}\Omega$ , $C_L = 100\text{ pF}$	25°C	2		MHz	
	$R_L = 600\ \Omega$ , $C_L = 100\text{ pF}$		1.5			
$t_s$ Settling time	0.1%	25°C	5		μs	
	0.01%		10			
$B_{OM}$ Maximum output-swing bandwidth	$A_{VD} = 1$ , $R_L = 10\text{ k}\Omega$	25°C	40		kHz	
$\phi_m$ Phase margin at unity gain (see Figure 3)	$R_L = 10\text{ k}\Omega$ , $C_L = 100\text{ pF}$	25°C	60°			
	$R_L = 600\ \Omega$ , $C_L = 100\text{ pF}$		70°			

† Full range is 0°C to 70°C.



**TLE206x, TLE206xA, TLE206xB**  
**EXCALIBUR JFET-INPUT HIGH-OUTPUT-DRIVE**  
**μPOWER OPERATIONAL AMPLIFIERS**

SLOS193B – FEBRUARY 1997 – REVISED MAY 2004

**TLE2061I electrical characteristics at specified free-air temperature,  $V_{CC\pm} = \pm 5\text{ V}$  (unless otherwise noted)**

PARAMETER		TEST CONDITIONS	$T_A$ †	TLE2061I, TLE2061AI TLE2061BI			UNIT		
				MIN	TYP	MAX			
$V_{IO}$	Input offset voltage	$V_{IC} = 0,$ $R_S = 50\ \Omega$	25°C	0.8	3.1	mV			
			Full range		4.4				
			25°C	0.6	2.6				
			Full range		3.9				
			25°C	0.5	1.9				
			Full range		2.7				
			$\alpha_{VIO}$	Temperature coefficient of input offset voltage	Full range		6		$\mu\text{V}/^\circ\text{C}$
				Input offset voltage long-term drift (see Note 4)	25°C		0.04		$\mu\text{V}/\text{mo}$
					25°C		1		pA
$I_{IO}$	Input offset current	Full range		2	nA				
$I_{IB}$	Input bias current	25°C	3		pA				
		Full range		4	nA				
$V_{ICR}$	Common-mode input voltage range		25°C	-1.6 to 4	-2 to 6	V			
			Full range	-1.6 to 4		V			
$V_{OM+}$	Maximum positive peak output voltage swing	$R_L = 10\ \text{k}\Omega$	25°C	3.5	3.7	V			
			Full range		3.1				
			25°C	2.5	3.1				
			Full range		2				
$V_{OM-}$	Maximum negative peak output voltage swing	$R_L = 10\ \text{k}\Omega$	25°C	-3.7	-3.9	V			
			Full range		-3.1				
			25°C	-2.5	-2.7				
			Full range		-2				
$A_{VD}$	Large-signal differential voltage amplification	$V_O = \pm 2.8\ \text{V},$ $R_L = 10\ \text{k}\Omega$	25°C	15	80	V/mV			
			Full range		2				
			25°C	0.75	45				
			Full range		0.5				
			25°C	0.5	3				
			Full range		0.25				
$r_i$	Input resistance		25°C	$10^{12}$		$\Omega$			
$c_i$	Input capacitance		25°C	4		pF			
$z_o$	Open-loop output impedance	$I_O = 0$	25°C	280		$\Omega$			
CMRR	Common-mode rejection ratio	$V_{IC} = V_{ICR\text{min}},$ $R_S = 50\ \Omega$	25°C	65	82	dB			
			Full range		65				
kSVR	Supply-voltage rejection ratio ( $\Delta V_{CC\pm}/\Delta V_{IO}$ )	$V_{CC\pm} = \pm 5\ \text{V to } \pm 15\ \text{V},$ $R_S = 50\ \Omega$	25°C	75	93	dB			
			Full range		65				
$I_{CC}$	Supply current	$V_O = 0,$ No load	25°C	280	325	$\mu\text{A}$			
			Full range		350				
$\Delta I_{CC}$	Supply-current change over operating temperature range		Full range	29		$\mu\text{A}$			

† Full range is -40°C to 85°C.

NOTE 4: Typical values are based on the input offset voltage shift observed through 168 hours of operating life test at  $T_A = 150^\circ\text{C}$  extrapolated to  $T_A = 25^\circ\text{C}$  using the Arrhenius equation and assuming an activation energy of 0.96 eV.



**TLE206x, TLE206xA, TLE206xB**  
**EXCALIBUR JFET-INPUT HIGH-OUTPUT-DRIVE**  
**μPOWER OPERATIONAL AMPLIFIERS**

SLOS193B – FEBRUARY 1997 – REVISED MAY 2004

**TLE20611 operating characteristics at specified free-air temperature,  $V_{CC\pm} = \pm 5\text{ V}$**

PARAMETER	TEST CONDITIONS	$T_A$ †	TLE20611 TLE2061AI TLE2061BI			UNIT
			MIN	TYP	MAX	
SR Slew rate at unity gain (see Figure 1)	$R_L = 10\text{ k}\Omega$ , $C_L = 100\text{ pF}$	25°C	2.2	3.4		V/μs
		Full range	1.7			
$V_n$ Equivalent input noise voltage (see Figure 2)	$f = 10\text{ Hz}$ , $R_S = 20\ \Omega$	25°C		59	100	nV/√Hz
	$f = 1\text{ kHz}$ , $R_S = 20\ \Omega$			43	60	
$V_{N(PP)}$ Peak-to-peak equivalent input noise voltage	$f = 0.1\text{ Hz to }10\text{ Hz}$	25°C	1.1		μV	
$I_n$ Equivalent input noise current	$f = 1\text{ kHz}$	25°C	1		fA/√Hz	
THD Total harmonic distortion	$A_{VD} = 2$ , $f = 10\text{ kHz}$ , $V_{O(PP)} = 2\text{ V}$ , $R_L = 10\text{ k}\Omega$	25°C	0.025%			
$B_1$ Unity-gain bandwidth (see Figure 3)	$R_L = 10\text{ k}\Omega$ , $C_L = 100\text{ pF}$	25°C	1.8		MHz	
	$R_L = 100\ \Omega$ , $C_L = 100\text{ pF}$		1.3			
$t_s$ Settling time	0.1%	25°C	5		μs	
	0.01%		10			
$B_{OM}$ Maximum output-swing bandwidth	$A_{VD} = 1$ , $R_L = 10\text{ k}\Omega$	25°C	140		kHz	
$\phi_m$ Phase margin at unity gain (see Figure 3)	$R_L = 10\text{ k}\Omega$ , $C_L = 100\text{ pF}$	25°C	58°			
	$R_L = 100\ \Omega$ , $C_L = 100\text{ pF}$		75°			

† Full range is –40°C to 85°C.

# TLE206x, TLE206xA, TLE206xB EXCALIBUR JFET-INPUT HIGH-OUTPUT-DRIVE μPOWER OPERATIONAL AMPLIFIERS

SLOS193B – FEBRUARY 1997 – REVISED MAY 2004

TLE2061I electrical characteristics at specified free-air temperature,  $V_{CC\pm} = \pm 15\text{ V}$  (unless otherwise noted)

PARAMETER		TEST CONDITIONS	$T_A$ †	TLE2061I, TLE2061AI TLE2061BI			UNIT
				MIN	TYP	MAX	
$V_{IO}$	Input offset voltage		25°C	TLE2061I		0.6	3
				Full range		4.3	
				TLE2061AI		0.5	1.5
				Full range		2.9	
				TLE2061BI		0.3	0.5
				Full range		1.3	
$\alpha_{VIO}$	Temperature coefficient of input offset voltage	$V_{IC} = 0,$ $R_S = 50\ \Omega$	Full range	6		$\mu\text{V}/^\circ\text{C}$	
	Input offset voltage long-term drift (see Note 4)			25°C	0.04		$\mu\text{V}/\text{mo}$
$I_{IO}$	Input offset current			25°C	2		pA
				Full range	3		nA
$I_{IB}$	Input bias current			25°C	4		pA
				Full range	5		nA
$V_{ICR}$	Common-mode input voltage range	25°C	-11 to 13	-12 to 16	V		
		Full range	-11 to 13		V		
$V_{OM+}$	Maximum positive peak output voltage swing	$R_L = 10\ \text{k}\Omega$	25°C	13.2	13.7	V	
			Full range	13			
		$R_L = 600\ \Omega$	25°C	12.5	13.2		
			Full range	12			
$V_{OM-}$	Maximum negative peak output voltage swing	$R_L = 10\ \text{k}\Omega$	25°C	-13.2	-13.7	V	
			Full range	-13			
		$R_L = 600\ \Omega$	25°C	-12.5	-13		
			Full range	-12			
$A_{VD}$	Large-signal differential voltage amplification	$V_O = \pm 10\ \text{V},$ $R_L = 10\ \text{k}\Omega$	25°C	30	230	V/mV	
			Full range	20			
		$V_O = 0\ \text{to}\ 8\ \text{V},$ $R_L = 600\ \Omega$	25°C	25	100		
			Full range	10			
		$V_O = 0\ \text{to}\ -8\ \text{V},$ $R_L = 600\ \Omega$	25°C	3	25		
			Full range	01			
$r_i$	Input resistance		25°C	$10^{12}$		$\Omega$	
$c_i$	Input capacitance		25°C	4		pF	
$z_o$	Open-loop output impedance	$I_O = 0$	25°C	280		$\Omega$	
CMRR	Common-mode rejection ratio	$V_{IC} = V_{ICR\text{min}},$ $R_S = 50\ \Omega$	25°C	72	90	dB	
			Full range	65			
$k_{SVR}$	Supply-voltage rejection ratio ( $\Delta V_{CC\pm}/\Delta V_{IO}$ )	$V_{CC\pm} = \pm 5\ \text{V}\ \text{to}\ \pm 15\ \text{V},$ $R_S = 50\ \Omega$	25°C	75	93	dB	
			Full range	65			
$I_{CC}$	Supply current	$V_O = 0,$ No load	25°C	290	350	$\mu\text{A}$	
			Full range	375			
$\Delta I_{CC}$	Supply-current change over operating temperature range		Full range	34		$\mu\text{A}$	

† Full range is  $-40^\circ\text{C}$  to  $85^\circ\text{C}$ .

NOTE 4: Typical values are based on the input offset voltage shift observed through 168 hours of operating life test at  $T_A = 150^\circ\text{C}$  extrapolated to  $T_A = 25^\circ\text{C}$  using the Arrhenius equation and assuming an activation energy of 0.96 eV.



**TLE206x, TLE206xA, TLE206xB**  
**EXCALIBUR JFET-INPUT HIGH-OUTPUT-DRIVE**  
**μPOWER OPERATIONAL AMPLIFIERS**

SLOS193B – FEBRUARY 1997 – REVISED MAY 2004

**TLE2061I operating characteristics at specified free-air temperature,  $V_{CC\pm} = \pm 15\text{ V}$**

PARAMETER	TEST CONDITIONS	$T_A$ †	TLE2061I TLE2061AI TLE2061BI			UNIT
			MIN	TYP	MAX	
SR Slew rate at unity gain (see Figure 1)	$R_L = 10\text{ k}\Omega$ , $C_L = 100\text{ pF}$	25°C	2.6	3.4		V/ $\mu$ s
		Full range	2.1			
$V_n$ Equivalent input noise voltage (see Figure 2)	$f = 10\text{ Hz}$ , $R_S = 20\ \Omega$	25°C		70	100	nV/ $\sqrt{\text{Hz}}$
	$f = 1\text{ kHz}$ , $R_S = 20\ \Omega$			40	60	
$V_{N(PP)}$ Peak-to-peak equivalent input noise voltage	$f = 0.1\text{ Hz to }10\text{ Hz}$	25°C		1.1		$\mu$ V
$I_n$ Equivalent input noise current	$f = 1\text{ kHz}$	25°C		1.1		fA/ $\sqrt{\text{Hz}}$
THD Total harmonic distortion	$A_{VD} = 2$ , $f = 10\text{ kHz}$ , $V_{O(PP)} = 2\text{ V}$ , $R_L = 10\text{ k}\Omega$	25°C		0.025%		
$B_1$ Unity-gain bandwidth (see Figure 3)	$R_L = 10\text{ k}\Omega$ , $C_L = 100\text{ pF}$	25°C		2		MHz
	$R_L = 600\ \Omega$ , $C_L = 100\text{ pF}$			1.5		
$t_s$ Settling time	0.1%	25°C		5		$\mu$ s
	0.01%			10		
$B_{OM}$ Maximum output-swing bandwidth	$A_{VD} = 1$ , $R_L = 10\text{ k}\Omega$	25°C		40		kHz
$\phi_m$ Phase margin at unity gain (see Figure 3)	$R_L = 10\text{ k}\Omega$ , $C_L = 100\text{ pF}$	25°C		60°		
	$R_L = 600\ \Omega$ , $C_L = 100\text{ pF}$			70°		

† Full range is  $-40^\circ\text{C}$  to  $85^\circ\text{C}$ .

**TLE206x, TLE206xA, TLE206xB**  
**EXCALIBUR JFET-INPUT HIGH-OUTPUT-DRIVE**  
**μPOWER OPERATIONAL AMPLIFIERS**

SLOS193B – FEBRUARY 1997 – REVISED MAY 2004

**TLE2061M electrical characteristics at specified free-air temperature,  $V_{CC\pm} = \pm 5\text{ V}$  (unless otherwise noted)**

PARAMETER		TEST CONDITIONS	$T_A$ †	TLE2061M TLE2061AM TLE2061BM			UNIT		
				MIN	TYP	MAX			
$V_{IO}$	Input offset voltage	$V_{IC} = 0, R_S = 50\ \Omega$	25°C	0.8	3.1	mV			
			Full range	6					
			25°C	0.6	2.6				
			Full range	4.6					
			25°C	0.5	1.9				
			Full range	3.1					
			$\alpha_{VIO}$	Temperature coefficient of input offset voltage	Full range		6		$\mu\text{V}/^\circ\text{C}$
				Input offset voltage long-term drift (see Note 4)	25°C		0.04		$\mu\text{V}/\text{mo}$
			$I_{IO}$	Input offset current	25°C		1		pA
		Full range	15		nA				
$I_{IB}$	Input bias current	25°C	3		pA				
		Full range	30		nA				
$V_{ICR}$	Common-mode input voltage range		25°C	-1.6 to 4	-2 to 6	V			
			Full range	-1.6 to 4		V			
$V_{OM+}$	Maximum positive peak output voltage swing	$R_L = 10\ \text{k}\Omega$	25°C	3.5	3.7	V			
			Full range	3					
			25°C	2.5	3.6				
			Full range	2					
			25°C	2.5	3.1				
			Full range	2					
$V_{OM-}$	Maximum negative peak output voltage swing	$R_L = 10\ \text{k}\Omega$	25°C	-3.5	-3.9	V			
			Full range	-3					
		FK and JG packages	$R_L = 600\ \Omega$	25°C	-2.5		-3.5		
				Full range	-2				
		D and P packages	$R_L = 100\ \Omega$	25°C	-2.5		-2.7		
				Full range	-2				
$AVD$	Large-signal differential voltage amplification		25°C	15	80	V/mV			
							Full range	2	
			FK and JG packages	$V_O = 0\ \text{to}\ 2.5\ \text{V}, R_L = 600\ \Omega$	25°C		1	65	
					Full range		0.5		
			FK and JG packages	$V_O = 0\ \text{to}\ -2.5\ \text{V}, R_L = 600\ \Omega$	25°C		1	16	
					Full range		0.5		
			D and P packages	$V_O = 0\ \text{to}\ 2\ \text{V}, R_L = 100\ \Omega$	25°C		0.75	45	
					Full range		0.5		
			D and P packages	$V_O = 0\ \text{to}\ -2\ \text{V}, R_L = 100\ \Omega$	25°C		0.5	3	
					Full range		0.25		

† Full range is -55°C to 125°C.

NOTE 4: Typical values are based on the input offset voltage shift observed through 168 hours of operating life test at  $T_A = 150^\circ\text{C}$  extrapolated to  $T_A = 25^\circ\text{C}$  using the Arrhenius equation and assuming an activation energy of 0.96 eV.



**TLE206x, TLE206xA, TLE206xB**  
**EXCALIBUR JFET-INPUT HIGH-OUTPUT-DRIVE**  
**μPOWER OPERATIONAL AMPLIFIERS**

SLOS193B – FEBRUARY 1997 – REVISED MAY 2004

**TLE2061M electrical characteristics at specified free-air temperature,  $V_{CC\pm} = \pm 5\text{ V}$  (unless otherwise noted) (continued)**

PARAMETER	TEST CONDITIONS	$T_A$ †	TLE2061M TLE2061AM TLE2061BM			UNIT
			MIN	TYP	MAX	
$r_i$ Input resistance		25°C	10 <sup>12</sup>			Ω
$c_i$ Input capacitance		25°C	4			pF
$z_o$ Open-loop output impedance	$I_O = 0$	25°C	280			Ω
CMRR Common-mode rejection ratio	$V_{IC} = V_{ICRmin},$ $R_S = 50\ \Omega$	25°C	65	82		dB
		Full range	60			
$k_{SVR}$ Supply-voltage rejection ratio ( $\Delta V_{CC\pm}/\Delta V_{IO}$ )	$V_{CC\pm} = \pm 5\text{ V to } \pm 15\text{ V},$ $R_S = 50\ \Omega$	25°C	75	93		dB
		Full range	65			
$I_{CC}$ Supply current	$V_O = 0,$ No load	25°C	280	325		μA
		Full range		350		
$\Delta I_{CC}$ Supply-current change over operating temperature range		Full range	39			μA

† Full range is –55°C to 125°C.

**TLE2061M operating characteristics at specified free-air temperature,  $V_{CC\pm} = \pm 5\text{ V}, T_A = 25^\circ\text{C}$**

PARAMETER	TEST CONDITIONS	TLE2061M TLE2061AM TLE2061BM			UNIT
		MIN	TYP	MAX	
SR Slew rate at unity gain (see Figure 1)	$R_L = 10\text{ k}\Omega,$ $C_L = 100\text{ pF}$	3.4			V/μs
$V_n$ Equivalent input noise voltage (see Figure 2)	$f = 10\text{ Hz},$ $R_S = 20\ \Omega$	59			$nV/\sqrt{\text{Hz}}$
	$f = 1\text{ kHz},$ $R_S = 20\ \Omega$	43			
$V_{N(PP)}$ Peak-to-peak equivalent input noise voltage	$f = 0.1\text{ Hz to } 10\text{ Hz}$	1.1			μV
$I_n$ Equivalent input noise current	$f = 1\text{ kHz}$	1			fA/√Hz
THD Total harmonic distortion	$A_{VD} = 2,$ $f = 10\text{ kHz},$ $V_{O(PP)} = 2\text{ V},$ $R_L = 10\text{ k}\Omega$	0.025%			
$B_1$ Unity-gain bandwidth (see Figure 3)	$R_L = 10\text{ k}\Omega,$ $C_L = 100\text{ pF}$	1.8			MHz
	$R_L = 600\ \Omega,$ $C_L = 100\text{ pF}$	1.3			
$t_s$ Settling time	0.1%	5			μs
	0.01%	10			
$B_{OM}$ Maximum output-swing bandwidth	$A_{VD} = 1,$ $R_L = 10\text{ k}\Omega$	140			kHz
$\phi_m$ Phase margin at unity gain (see Figure 3)	$R_L = 10\text{ k}\Omega,$ $C_L = 100\text{ pF}$	58°			
	$R_L = 600\ \Omega,$ $C_L = 100\text{ pF}$	75°			

**TLE206x, TLE206xA, TLE206xB**  
**EXCALIBUR JFET-INPUT HIGH-OUTPUT-DRIVE**  
**μPOWER OPERATIONAL AMPLIFIERS**

SLOS193B – FEBRUARY 1997 – REVISED MAY 2004

**TLE2061M electrical characteristics at specified free-air temperature,  $V_{CC\pm} = \pm 15$  V (unless otherwise noted)**

PARAMETER		TEST CONDITIONS	$T_A$ †	TLE2061M ,TLE2061AM TLE2061BM			UNIT
				MIN	TYP	MAX	
$V_{IO}$	Input offset voltage		25°C	0.6		3	mV
				Full range		6	
			25°C	0.5		1.5	
				Full range		3.6	
			25°C	0.3		0.5	
				Full range		1.7	
$\alpha_{VIO}$	Temperature coefficient of input offset voltage	$V_{IC} = 0$ , $R_S = 50 \Omega$	Full range	6		$\mu V/^\circ C$	
	Input offset voltage long-term drift (see Note 4)		25°C	0.04		$\mu V/mo$	
$I_{IO}$	Input offset current		25°C	2		pA	
			Full range		20	nA	
$I_{IB}$	Input bias current		25°C	4		pA	
			Full range		40	nA	
$V_{ICR}$	Common-mode input voltage range	25°C	-11 to 13	-12 to 16	V		
		Full range		-11 to 13	V		
$V_{OM+}$	Maximum positive peak output voltage swing	$R_L = 10 k\Omega$	25°C	13	13.7	V	
			Full range		12.5		
		$R_L = 600 \Omega$	25°C	12.5	13.2		
			Full range		12		
$V_{OM-}$	Maximum negative peak output voltage swing	$R_L = 10 k\Omega$	25°C	-13	-13.7	V	
			Full range		-12.5		
		$R_L = 600 \Omega$	25°C	-12.5	-13		
			Full range		-12		
$A_{VD}$	Large-signal differential voltage amplification	$V_O = \pm 10$ V, $R_L = 10 k\Omega$	25°C	30	230	V/mV	
			Full range		20		
		$V_O = 0$ to 8 V, $R_L = 600 \Omega$	25°C	25	100		
			Full range		7		
		$V_O = 0$ to -8 V, $R_L = 600 \Omega$	25°C	3	25		
			Full range		1		
$r_i$	Input resistance		25°C	$10^{12}$		$\Omega$	
$c_i$	Input capacitance		25°C	4		pF	
$z_o$	Open-loop output impedance	$I_O = 0$	25°C	280		$\Omega$	
CMRR	Common-mode rejection ratio	$V_{IC} = V_{ICRmin}$ , $R_S = 50 \Omega$	25°C	72	90	dB	
			Full range		65		
$k_{SVR}$	Supply-voltage rejection ratio ( $\Delta V_{CC\pm} / \Delta V_{IO}$ )	$V_{CC\pm} = \pm 5$ V to $\pm 15$ V, $R_S = 50 \Omega$	25°C	75	93	dB	
			Full range		65		

† Full range is -55°C to 125°C.

NOTE 4: Typical values are based on the input offset voltage shift observed through 168 hours of operating life test at  $T_A = 150^\circ C$  extrapolated to  $T_A = 25^\circ C$  using the Arrhenius equation and assuming an activation energy of 0.96 eV.





**TLE206x, TLE206xA, TLE206xB**  
**EXCALIBUR JFET-INPUT HIGH-OUTPUT-DRIVE**  
**μPOWER OPERATIONAL AMPLIFIERS**

SLOS193B – FEBRUARY 1997 – REVISED MAY 2004

**TLE2061M electrical characteristics at specified free-air temperature,  $V_{CC\pm} = \pm 15$  V (unless otherwise noted) (continue)**

PARAMETER	TEST CONDITIONS	$T_A$ †	TLE2061M ,TLE2061AM TLE2061BM			UNIT
			MIN	TYP	MAX	
$I_{CC}$ Supply current	$V_O = 0$ , No load	25°C		290	350	μA
		Full range			375	
$\Delta I_{CC}$ Supply-current change over operating temperature range		Full range		46		μA

† Full range is –55°C to 125°C.

**TLE2061M operating characteristics at specified free-air temperature,  $V_{CC\pm} = \pm 15$  V**

PARAMETER	TEST CONDITIONS	$T_A$ †	TLE2061M TLE2061AM TLE2061BM			UNIT
			MIN	TYP	MAX	
SR Slew rate at unity gain (see Figure 1)	$R_L = 10$ kΩ, $C_L = 100$ pF	25°C	2	3.4		V/μs
		Full range	1.8			
$V_n$ Equivalent input noise voltage (see Figure 2)	$f = 10$ Hz, $R_S = 20$ Ω	25°C		70		nV/√Hz
	$f = 1$ kHz, $R_S = 20$ Ω	25°C		40		
$V_{N(PP)}$ Peak-to-peak equivalent input noise voltage	$f = 0.1$ Hz to 10 Hz	25°C		1.1		μV
$I_n$ Equivalent input noise current	$f = 1$ kHz	25°C		1.1		fA/√Hz
THD Total harmonic distortion	$A_{VD} = 2$ , $f = 10$ kHz, $V_{O(PP)} = 2$ V, $R_L = 10$ kΩ	25°C		0.025%		
$B_1$ Unity-gain bandwidth (see Figure 3)	$R_L = 10$ kΩ, $C_L = 100$ pF	25°C		2		MHz
	$R_L = 600$ Ω, $C_L = 100$ pF	25°C		1.5		
$t_s$ Settling time	0.1%	25°C		5		μs
	0.01%	25°C		10		
$B_{OM}$ Maximum output-swing bandwidth	$A_{VD} = 1$ , $R_L = 10$ kΩ	25°C		40		kHz
$\phi_m$ Phase margin at unity gain (see Figure 3)	$R_L = 10$ kΩ, $C_L = 100$ pF	25°C		60°		
	$R_L = 600$ Ω, $C_L = 100$ pF	25°C		70°		

† Full range is –55°C to 125°C.

# TLE206x, TLE206xA, TLE206xB EXCALIBUR JFET-INPUT HIGH-OUTPUT-DRIVE μPOWER OPERATIONAL AMPLIFIERS

SLOS193B – FEBRUARY 1997 – REVISED MAY 2004

## TLE2061Y electrical characteristics at $V_{CC\pm} = \pm 15\text{ V}$ , $T_A = 25^\circ\text{C}$ (unless otherwise noted)

PARAMETER	TEST CONDITIONS	TLE2061Y			UNIT
		MIN	TYP	MAX	
$V_{IO}$ Input offset voltage	$V_{IC} = 0$ , $R_S = 50\ \Omega$		0.6	3	mV
$\alpha V_{IO}$ Input offset voltage long-term drift (see Note 4)			0.04		$\mu\text{V}/\text{mo}$
$I_{IO}$ Input offset current			2		pA
$I_{IB}$ Input bias current			4		pA
$V_{ICR}$ Common-mode input voltage range		-11 to 13	-12 to 16		V
$V_{OM+}$ Maximum positive peak output voltage swing	$R_L = 10\ \text{k}\Omega$	13.2	13.7		V
	$R_L = 600\ \Omega$	12.5	13.2		
$V_{OM-}$ Maximum negative peak output voltage swing	$R_L = 10\ \text{k}\Omega$	-13.2	-13.7		V
	$R_L = 600\ \Omega$	-12.5	-13		
$A_{VD}$ Large-signal differential voltage amplification	$V_O = \pm 10\ \text{V}$ , $R_L = 10\ \text{k}\Omega$	30	230		V/mV
	$V_O = 0\ \text{to}\ 8\ \text{V}$ , $R_L = 600\ \Omega$	25	100		
	$V_O = 0\ \text{to}\ -8\ \text{V}$ , $R_L = 600\ \Omega$	3	25		
$r_i$ Input resistance			$10^{12}$		$\Omega$
$c_i$ Input capacitance			4		pF
$z_o$ Open-loop output impedance	$I_O = 0$		280		$\Omega$
CMRR Common-mode rejection ratio	$R_S = 50\ \Omega$ , $V_{IC} = V_{ICR\text{min}}$	72	90		dB
$k_{SVR}$ Supply-voltage rejection ratio ( $\Delta V_{CC}/\Delta V_{IO}$ )	$V_{CC\pm} = \pm 5\ \text{V}\ \text{to}\ \pm 15\ \text{V}$ , $R_S = 50\ \Omega$	75	93		dB
$I_{CC}$ Supply current	$V_O = 0$ , No load		290	350	$\mu\text{A}$

NOTE 4: Typical values are based on the input offset voltage shift observed through 168 hours of operating life test at  $T_A = 150^\circ\text{C}$  extrapolated to  $T_A = 25^\circ\text{C}$  using the Arrhenius equation and assuming an activation energy of 0.96 eV.

## TLE2061Y operating characteristics at $V_{CC\pm} = \pm 15\ \text{V}$ , $T_A = 25^\circ\text{C}$

PARAMETER	TEST CONDITIONS	TLE2061Y			UNIT
		MIN	TYP	MAX	
SR Slew rate at unity gain (see Figure 1)	$R_L = 10\ \text{k}\Omega$ , $C_L = 100\ \text{pF}$	2.6	3.4		V/ $\mu\text{s}$
$V_n$ Equivalent input noise voltage (see Figure 2)	$f = 10\ \text{Hz}$ , $R_S = 20\ \Omega$		70		nV/ $\sqrt{\text{Hz}}$
	$f = 1\ \text{kHz}$ , $R_S = 20\ \Omega$		40		
$V_{N(PP)}$ Peak-to-peak equivalent input noise voltage	$f = 0.1\ \text{Hz}\ \text{to}\ 10\ \text{Hz}$		1.1		$\mu\text{V}$
$I_n$ Equivalent input noise current	$f = 1\ \text{Hz}$		1.1		fA/ $\sqrt{\text{Hz}}$
THD Total harmonic distortion	$A_{VD} = 2$ , $f = 10\ \text{kHz}$ , $V_{O(PP)} = 2\ \text{V}$ , $R_L = 10\ \text{k}\Omega$		0.025%		
$B_1$ Unity-gain bandwidth (see Figure 3)	$R_L = 10\ \text{k}\Omega$ , $C_L = 100\ \text{pF}$		2		MHz
	$R_L = 600\ \Omega$ , $C_L = 100\ \text{pF}$		1.5		
$t_s$ Settling time	0.1%		5		$\mu\text{s}$
	0.01%		10		
BOM Maximum output-swing bandwidth	$A_{VD} = 1$ , $R_L = 10\ \text{k}\Omega$		40		kHz
$\phi_m$ Phase margin at unity gain (see Figure 3)	$R_L = 10\ \text{k}\Omega$ , $C_L = 100\ \text{pF}$		60°		
	$R_L = 600\ \Omega$ , $C_L = 100\ \text{pF}$		70°		



**TLE206x, TLE206xA, TLE206xB**  
**EXCALIBUR JFET-INPUT HIGH-OUTPUT-DRIVE**  
**μPOWER OPERATIONAL AMPLIFIERS**

SLOS193B – FEBRUARY 1997 – REVISED MAY 2004

**TLE2062C electrical characteristics at specified free-air temperature,  $V_{CC\pm} = \pm 5\text{ V}$  (unless otherwise noted)**

PARAMETER		TEST CONDITIONS	$T_A^\dagger$	TLE2062C TLE2062AC TLE2062BC			UNIT
				MIN	TYP	MAX	
$V_{IO}$	Input offset voltage	$V_{IC} = 0,$ $R_S = 50\ \Omega$	25°C	1	5	mV	
			Full range	5.9			
			25°C	0.9	4		
			Full range	4.9			
			25°C	0.7	3		
			Full range	3.9			
$\alpha_{VIO}$	Temperature coefficient of input offset voltage	$V_{IC} = 0,$ $R_S = 50\ \Omega$	Full range	6		$\mu\text{V}/^\circ\text{C}$	
	Input offset voltage long-term drift (see Note 4)		25°C	0.04		$\mu\text{V}/\text{mo}$	
$I_{IO}$	Input offset current		25°C	1		pA	
			Full range	0.8		nA	
$I_{IB}$	Input bias current		25°C	3		pA	
			Full range	2		nA	
$V_{ICR}$	Common-mode input voltage range		25°C	-1.6 to 4	-2 to 6	V	
			Full range	-1.6 to 4		V	
$V_{OM+}$	Maximum positive peak output voltage swing	$R_L = 10\ \text{k}\Omega$	25°C	3.5	3.7	V	
			Full range	3.3			
			25°C	2.5	3.1		
			Full range	2			
$V_{OM-}$	Maximum negative peak output voltage swing	$R_L = 10\ \text{k}\Omega$	25°C	-3.7	-3.9	V	
			Full range	-3.3			
			25°C	-2.5	-2.7		
			Full range	-2			
$A_{VD}$	Large-signal differential voltage amplification	$V_O = \pm 2.8\ \text{V},$ $R_L = 10\ \text{k}\Omega$	25°C	15	80	V/mV	
			Full range	2			
		$V_O = 0\ \text{to}\ 2\ \text{V},$ $R_L = 100\ \Omega$	25°C	0.75	45		
			Full range	0.5			
		$V_O = 0\ \text{to}\ -2\ \text{V},$ $R_L = 100\ \Omega$	25°C	0.5	3		
			Full range	0.25			
$r_i$	Input resistance		25°C	$10^{12}$		$\Omega$	
$c_i$	Input capacitance		25°C	4		pF	
$z_o$	Open-loop output impedance	$I_O = 0$	25°C	560		$\Omega$	
CMRR	Common-mode rejection ratio	$V_{IC} = V_{ICR\text{min}},$ $R_S = 50\ \Omega$	25°C	65	82	dB	
			Full range	65			
$k_{SVR}$	Supply-voltage rejection ratio ( $\Delta V_{CC\pm}/\Delta V_{IO}$ )	$V_{CC\pm} = \pm 5\ \text{V}\ \text{to}\ \pm 15\ \text{V},$ $R_S = 50\ \Omega$	25°C	75	93	dB	
			Full range	75			

$^\dagger$  Full range is 0°C to 70°C.

NOTE 4: Typical values are based on the input offset voltage shift observed through 168 hours of operating life test at  $T_A = 150^\circ\text{C}$  extrapolated to  $T_A = 25^\circ\text{C}$  using the Arrhenius equation and assuming an activation energy of 0.96 eV.



**TLE206x, TLE206xA, TLE206xB**  
**EXCALIBUR JFET-INPUT HIGH-OUTPUT-DRIVE**  
**μPOWER OPERATIONAL AMPLIFIERS**

SLOS193B – FEBRUARY 1997 – REVISED MAY 2004

**TLE2062C electrical characteristics at specified free-air temperature,  $V_{CC\pm} = \pm 5\text{ V}$  (unless otherwise noted) (continued)**

PARAMETER	TEST CONDITIONS	$T_A$ †	TLE2062C TLE2062AC TLE2062BC			UNIT
			MIN	TYP	MAX	
$I_{CC}$ Supply current	$V_O = 0$ , No load	25°C		560	620	μA
		Full range			635	
$\Delta I_{CC}$ Supply-current change over operating temperature range		Full range		26		μA

† Full range is 0°C to 70°C.

**TLE2062C operating characteristics at specified free-air temperature,  $V_{CC\pm} = \pm 5\text{ V}$**

PARAMETER	TEST CONDITIONS	$T_A$ †	TLE2062C TLE2062AC TLE2062BC			UNIT
			MIN	TYP	MAX	
SR Slew rate at unity gain (see Figure 1)	$R_L = 10\text{ k}\Omega$ , $C_L = 100\text{ pF}$	25°C	2.2	3.4		V/μs
		Full range	2.1			
$V_n$ Equivalent input noise voltage (see Figure 2)	$f = 10\text{ Hz}$ , $R_S = 20\ \Omega$	25°C		59	100	nV/√Hz
	$f = 1\text{ kHz}$ , $R_S = 20\ \Omega$	25°C		43	60	
$V_{N(PP)}$ Peak-to-peak equivalent input noise voltage	$f = 0.1\text{ Hz to }10\text{ Hz}$	25°C		1.1		μV
$I_n$ Equivalent input noise current	$f = 1\text{ kHz}$	25°C		1		fA/√Hz
THD Total harmonic distortion	$V_{O(PP)} = 2\text{ V}$ , $R_L = 10\text{ k}\Omega$ , $A_{VD} = 2$ , $f = 10\text{ kHz}$	25°C		0.025%		
$B_1$ Unity-gain bandwidth (see Figure 3)	$R_L = 10\text{ k}\Omega$ , $C_L = 100\text{ pF}$	25°C		1.8		MHz
	$R_L = 100\ \Omega$ , $C_L = 100\text{ pF}$	25°C		1.3		
Settling time	0.1%	25°C		5		μs
	0.01%	25°C		10		
BOM Maximum output-swing bandwidth	$A_{VD} = 1$ , $R_L = 10\text{ k}\Omega$	25°C		140		kHz
$\phi_m$ Phase margin at unity gain (see Figure 3)	$R_L = 10\text{ k}\Omega$ , $C_L = 100\text{ pF}$	25°C		58°		
	$R_L = 100\ \Omega$ , $C_L = 100\text{ pF}$	25°C		75°		

† Full range is 0°C to 70°C.



**TLE206x, TLE206xA, TLE206xB**  
**EXCALIBUR JFET-INPUT HIGH-OUTPUT-DRIVE**  
**μPOWER OPERATIONAL AMPLIFIERS**

SLOS193B – FEBRUARY 1997 – REVISED MAY 2004

**TLE2062C electrical characteristics at specified free-air temperature,  $V_{CC\pm} = \pm 15\text{ V}$  (unless otherwise noted)**

PARAMETER		TEST CONDITIONS	$T_A$ †	TLE2062C TLE2062AC TLE2062BC			UNIT	
				MIN	TYP	MAX		
$V_{IO}$ Input offset voltage	TLE2062C	$V_{IC} = 0, \quad R_S = 50\ \Omega$	25°C	0.9	4	mV		
			Full range		4.9			
	TLE2062AC		25°C	0.8	2			
			Full range		2.9			
	TLE2062BC		25°C	0.5	1			
			Full range		1.9			
	$\alpha V_{IO}$ Temperature coefficient of input offset voltage			Full range	6			$\mu\text{V}/^\circ\text{C}$
	Input offset voltage long-term drift (see Note 4)			25°C	0.04			$\mu\text{V}/\text{mo}$
$I_{IO}$ Input offset current		25°C	2		pA			
	Full range			1	nA			
$I_{IB}$ Input bias current		25°C	4		pA			
	Full range			3	nA			
$V_{ICR}$ Common-mode input voltage range		25°C	-11 to 13	-12 to 16	V			
	Full range		-11 to 13		V			
$V_{OM+}$ Maximum positive peak output voltage swing	$R_L = 10\ \text{k}\Omega$	25°C	13.2	13.7	V			
		Full range	13					
	$R_L = 600\ \Omega$	25°C	12.5	13.2				
		Full range	12					
$V_{OM-}$ Maximum negative peak output voltage swing	$R_L = 10\ \text{k}\Omega$	25°C	-13.2	-13.7	V			
		Full range	-13					
	$R_L = 600\ \Omega$	25°C	-12.5	-13				
		Full range	-12					
$A_{VD}$ Large-signal differential voltage amplification	$V_O = \pm 10\ \text{V}, \quad R_L = 10\ \text{k}\Omega$	25°C	30	230	V/mV			
		Full range	20					
	$V_O = 0\ \text{to}\ 8\ \text{V}, \quad R_L = 600\ \Omega$	25°C	25	100				
		Full range	10					
	$V_O = 0\ \text{to}\ -8\ \text{V}, \quad R_L = 600\ \Omega$	25°C	3	25				
		Full range	1					
$r_i$ Input resistance		25°C		$10^{12}$	$\Omega$			
$c_i$ Input capacitance		25°C		4	pF			
$z_o$ Open-loop output impedance	$I_O = 0$	25°C		560	$\Omega$			
CMRR Common-mode rejection ratio	$V_{IC} = V_{ICR\text{min}}, \quad R_S = 50\ \Omega$	25°C	72	90	dB			
		Full range	70					
$k_{SVR}$ Supply-voltage rejection ratio ( $\Delta V_{CC\pm}/\Delta V_{IO}$ )	$V_{CC\pm} = \pm 5\ \text{V}\ \text{to}\ \pm 15\ \text{V}, \quad R_S = 50\ \Omega$	25°C	75	93	dB			
		Full range	75					

† Full range is 0°C to 70°C.

NOTE 4: Typical values are based on the input offset voltage shift observed through 168 hours of operating life test at  $T_A = 150^\circ\text{C}$  extrapolated to  $T_A = 25^\circ\text{C}$  using the Arrhenius equation and assuming an activation energy of 0.96 eV.



**TLE206x, TLE206xA, TLE206xB**  
**EXCALIBUR JFET-INPUT HIGH-OUTPUT-DRIVE**  
**μPOWER OPERATIONAL AMPLIFIERS**

SLOS193B – FEBRUARY 1997 – REVISED MAY 2004

**TLE2062C electrical characteristics at specified free-air temperature,  $V_{CC\pm} = \pm 15$  V (unless otherwise noted) (continued)**

PARAMETER	TEST CONDITIONS	$T_A$ †	TLE2062C TLE2062AC TLE2062BC			UNIT
			MIN	TYP	MAX	
$I_{CC}$ Supply current	$V_O = 0$ V, No load	25°C		625	690	μA
		Full range		715		
$\Delta I_{CC}$ Supply-current change over operating temperature range		Full range		36		μA

† Full range is 0°C to 70°C.

**TLE2062C operating characteristics at specified free-air temperature,  $V_{CC\pm} = \pm 15$  V**

PARAMETER	TEST CONDITIONS	$T_A$ †	TLE2062C TLE2062AC TLE2062BC			UNIT
			MIN	TYP	MAX	
SR Slew rate at unity gain (see Figure 1)	$R_L = 10$ kΩ, $C_L = 100$ pF	25°C	2.6	3.4		V/μs
		Full range	2.5			
$V_n$ Equivalent input noise voltage (see Figure 2)	$f = 10$ Hz, $R_S = 20$ Ω	25°C		70	100	nV/√Hz
	$f = 1$ kHz, $R_S = 20$ Ω	25°C		40	60	
$V_{N(PP)}$ Peak-to-peak equivalent input noise voltage	$f = 0.1$ Hz to 10 Hz	25°C		1.1		μV
$I_n$ Equivalent input noise current	$f = 1$ kHz	25°C		1.1		fA/√Hz
THD Total harmonic distortion	$V_{O(PP)} = 2$ V, $R_L = 10$ kΩ, $A_{VD} = 2$ , $f = 10$ kHz	25°C	0.025%			
$B_1$ Unity-gain bandwidth (see Figure 3)	$R_L = 10$ kΩ, $C_L = 10$ pF	25°C	2			MHz
	$R_L = 600$ Ω, $C_L = 100$ pF	25°C	1.5			
Settling time	0.1%	25°C	5			μs
	0.01%	25°C	10			
$B_{OM}$ Maximum output-swing bandwidth	$A_{VD} = 1$ , $R_L = 10$ kΩ	25°C	40			kHz
$\phi_m$ Phase margin at unity gain (see Figure 3)	$R_L = 10$ kΩ, $C_L = 100$ pF	25°C	60°			
	$R_L = 600$ Ω, $C_L = 100$ pF	25°C	70°			

† Full range is 0°C to 70°C.



**TLE206x, TLE206xA, TLE206xB**  
**EXCALIBUR JFET-INPUT HIGH-OUTPUT-DRIVE**  
**μPOWER OPERATIONAL AMPLIFIERS**

SLOS193B – FEBRUARY 1997 – REVISED MAY 2004

**TLE2062I electrical characteristics at specified free-air temperature,  $V_{CC\pm} = \pm 5\text{ V}$  (unless otherwise noted)**

PARAMETER		TEST CONDITIONS	$T_A^\dagger$	TLE2062I TLE2062AI TLE2062BI			UNIT
				MIN	TYP	MAX	
$V_{IO}$	Input offset voltage	$V_{IC} = 0, R_S = 50\ \Omega$	25°C	1	5	mV	
			Full range	6.3			
			25°C	0.9	4		
			Full range	5.3			
			25°C	0.7	3		
			Full range	4.3			
$\alpha_{VIO}$	Temperature coefficient of input offset voltage	$V_{IC} = 0, R_S = 50\ \Omega$	Full range	6		$\mu\text{V}/^\circ\text{C}$	
	Input offset voltage long-term drift (see Note 4)		25°C	0.04		$\mu\text{V}/\text{mo}$	
$I_{IO}$	Input offset current		25°C	1		pA	
			Full range	2		nA	
$I_{IB}$	Input bias current		25°C	3		pA	
			Full range	4		nA	
$V_{ICR}$	Common-mode input voltage range	25°C	-1.6 to 4	-2 to 6	V		
		Full range	-1.6 to 4		V		
$V_{OM+}$	Maximum positive peak output voltage swing	$R_L = 10\ \text{k}\Omega$	25°C	3.5	3.7	V	
			Full range	3.1			
			$R_L = 100\ \Omega$	25°C	2.5		3.1
				Full range	2		
$V_{OM-}$	Maximum negative peak output voltage swing	$R_L = 10\ \text{k}\Omega$	25°C	-3.7	-3.9	V	
			Full range	-3.1			
			$R_L = 100\ \Omega$	25°C	-2.5		-2.7
				Full range	-2		
$A_{VD}$	Large-signal differential voltage amplification	$V_O = \pm 2.8\ \text{V}, R_L = 10\ \text{k}\Omega$	25°C	15	80	V/mV	
			Full range	2			
			$V_O = 0\ \text{to}\ 2\ \text{V}, R_L = 100\ \Omega$	25°C	0.75		45
				Full range	0.5		
			$V_O = 0\ \text{to}\ -2\ \text{V}, R_L = 100\ \Omega$	25°C	0.5		3
				Full range	0.25		
$r_i$	Input resistance		25°C	$10^{12}$		$\Omega$	
$c_i$	Input capacitance		25°C	4		pF	
$z_o$	Open-loop output impedance	$I_O = 0$	25°C	560		$\Omega$	
CMRR	Common-mode rejection ratio	$V_{IC} = V_{ICRmin}, R_S = 50\ \Omega$	25°C	65	82	dB	
			Full range	65			
$k_{SVR}$	Supply-voltage rejection ratio ( $\Delta V_{CC\pm}/\Delta V_{IO}$ )	$V_{CC\pm} = \pm 5\ \text{V}\ \text{to}\ \pm 15\ \text{V}, R_S = 50\ \Omega$	25°C	75	93	dB	
			Full range	65			

$^\dagger$  Full range is  $-40^\circ\text{C}$  to  $85^\circ\text{C}$ .

NOTE 4: Typical values are based on the input offset voltage shift observed through 168 hours of operating life test at  $T_A = 150^\circ\text{C}$  extrapolated to  $T_A = 25^\circ\text{C}$  using the Arrhenius equation and assuming an activation energy of 0.96 eV.



**TLE206x, TLE206xA, TLE206xB**  
**EXCALIBUR JFET-INPUT HIGH-OUTPUT-DRIVE**  
**μPOWER OPERATIONAL AMPLIFIERS**

SLOS193B – FEBRUARY 1997 – REVISED MAY 2004

**TLE2062I electrical characteristics at specified free-air temperature,  $V_{CC\pm} = \pm 5\text{ V}$  (unless otherwise noted) (continued)**

PARAMETER	TEST CONDITIONS	$T_A$ †	TLE2062I TLE2062AI TLE2062BI			UNIT
			MIN	TYP	MAX	
$I_{CC}$ Supply current	$V_O = 0$ , No load	25°C		560	620	μA
		Full range			640	
$\Delta I_{CC}$ Supply-current change over operating temperature range		Full range		54		μA

† Full range is –40°C to 85°C.

**TLE2062I operating characteristics at specified free-air temperature,  $V_{CC\pm} = \pm 5\text{ V}$**

PARAMETER	TEST CONDITIONS	$T_A$ †	TLE2062I TLE2062AI TLE2062BI			UNIT
			MIN	TYP	MAX	
SR Slew rate at unity gain (see Figure 1)	$R_L = 10\text{ k}\Omega$ , $C_L = 100\text{ pF}$	25°C	2.2	3.4		V/μs
		Full range	1.7			
$V_n$ Equivalent input noise voltage (see Figure 2)	$f = 10\text{ Hz}$ , $R_S = 20\ \Omega$	25°C		59	100	$\text{nV}/\sqrt{\text{Hz}}$
	$f = 1\text{ kHz}$ , $R_S = 20\ \Omega$	25°C		43	60	
$V_{N(PP)}$ Peak-to-peak equivalent input noise voltage	$f = 0.1\text{ Hz to }10\text{ Hz}$	25°C		1.1		μV
$I_n$ Equivalent input noise current	$f = 1\text{ kHz}$	25°C		1		$\text{fA}/\sqrt{\text{Hz}}$
THD Total harmonic distortion	$V_{O(PP)} = 2\text{ V}$ , $R_L = 10\text{ k}\Omega$ , $A_{VD} = 2$ , $f = 10\text{ kHz}$	25°C		0.025%		
$B_1$ Unity-gain bandwidth (see Figure 3)	$R_L = 10\text{ k}\Omega$ , $C_L = 100\text{ pF}$	25°C		1.8		MHz
	$R_L = 100\ \Omega$ , $C_L = 100\text{ pF}$	25°C		1.3		
Settling time	0.1%	25°C		5		μs
	0.01%	25°C		10		
$B_{OM}$ Maximum output-swing bandwidth	$A_{VD} = 1$ , $R_L = 10\text{ k}\Omega$	25°C		140		kHz
$\phi_m$ Phase margin at unity gain (see Figure 3)	$R_L = 10\text{ k}\Omega$ , $C_L = 100\text{ pF}$	25°C		58°		
	$R_L = 100\ \Omega$ , $C_L = 100\text{ pF}$	25°C		75°		

† Full range is –40°C to 85°C.





**TLE206x, TLE206xA, TLE206xB**  
**EXCALIBUR JFET-INPUT HIGH-OUTPUT-DRIVE**  
**μPOWER OPERATIONAL AMPLIFIERS**

SLOS193B – FEBRUARY 1997 – REVISED MAY 2004

**TLE2062I electrical characteristics at specified free-air temperature,  $V_{CC\pm} = \pm 15\text{ V}$  (unless otherwise noted)**

PARAMETER		TEST CONDITIONS	$T_A$ †	TLE2062I TLE2062AI TLE2062BI			UNIT
				MIN	TYP	MAX	
$V_{IO}$	Input offset voltage	$V_{IC} = 0, R_S = 50\ \Omega$	25°C	0.9	4	mV	
			Full range	5.3			
			25°C	0.8	2		
			Full range	3.3			
			25°C	0.5	1		
			Full range	2.3			
$\alpha_{VIO}$	Temperature coefficient of input offset voltage	$V_{IC} = 0, R_S = 50\ \Omega$	Full range	6		$\mu\text{V}/^\circ\text{C}$	
	Input offset voltage long-term drift (see Note 4)		25°C	0.04		$\mu\text{V}/\text{mo}$	
$I_{IO}$	Input offset current		25°C	2		pA	
			Full range	3		nA	
$I_{IB}$	Input bias current		25°C	4		pA	
			Full range	5		nA	
$V_{ICR}$	Common-mode input voltage range	25°C	-11 to 13	-12 to 16		V	
		Full range	-11 to 13			V	
$V_{OM+}$	Maximum positive peak output voltage swing	$R_L = 10\ \text{k}\Omega$	25°C	13.2	13.7	V	
			Full range	13			
		$R_L = 600\ \Omega$	25°C	12.5	13.2		
			Full range	12			
$V_{OM-}$	Maximum negative peak output voltage swing	$R_L = 10\ \text{k}\Omega$	25°C	-13.2	-13.7	V	
			Full range	-13			
		$R_L = 600\ \Omega$	25°C	-12.5	-13		
			Full range	-12			
$A_{VD}$	Large-signal differential voltage amplification	$V_O = \pm 10\ \text{V}, R_L = 10\ \text{k}\Omega$	25°C	30	230	V/mV	
			Full range	20			
		$V_O = 0\ \text{to}\ 8\ \text{V}, R_L = 600\ \Omega$	25°C	25	100		
			Full range	10			
		$V_O = 0\ \text{to}\ -8\ \text{V}, R_L = 600\ \Omega$	25°C	3	25		
			Full range	1			
$r_i$	Input resistance		25°C	$10^{12}$		$\Omega$	
$c_i$	Input capacitance		25°C	4		pF	
$z_o$	Open-loop output impedance	$I_O = 0$	25°C	560		$\Omega$	
CMRR	Common-mode rejection ratio	$V_{IC} = V_{ICRmin}, R_S = 50\ \Omega$	25°C	72	90	dB	
			Full range	65			
k <sub>SVR</sub>	Supply-voltage rejection ratio ( $\Delta V_{CC\pm}/\Delta V_{IO}$ )	$V_{CC\pm} = \pm 5\ \text{V}\ \text{to}\ \pm 15\ \text{V}, R_S = 50\ \Omega$	25°C	75	93	dB	
			Full range	65			

† Full range is -40°C to 85°C.

NOTE 4: Typical values are based on the input offset voltage shift observed through 168 hours of operating life test at  $T_A = 150^\circ\text{C}$  extrapolated to  $T_A = 25^\circ\text{C}$  using the Arrhenius equation and assuming an activation energy of 0.96 eV.



**TLE206x, TLE206xA, TLE206xB**  
**EXCALIBUR JFET-INPUT HIGH-OUTPUT-DRIVE**  
**μPOWER OPERATIONAL AMPLIFIERS**

SLOS193B – FEBRUARY 1997 – REVISED MAY 2004

**TLE2062I electrical characteristics at specified free-air temperature,  $V_{CC\pm} = \pm 15$  V (unless otherwise noted) (continued)**

PARAMETER	TEST CONDITIONS	$T_A$ †	TLE2062I TLE2062AI TLE2062BI			UNIT
			MIN	TYP	MAX	
$I_{CC}$ Supply current	$V_O = 0$ , No load	25°C		625	690	μA
		Full range			720	
$\Delta I_{CC}$ Supply-current change over operating temperature range		Full range		74		μA

† Full range is –40°C to 85°C.

**TLE2062I operating characteristics at specified free-air temperature,  $V_{CC\pm} = \pm 15$  V**

PARAMETER	TEST CONDITIONS	$T_A$ †	TLE2062I TLE2062AI TLE2062BI			UNIT
			MIN	TYP	MAX	
SR Slew rate at unity gain (see Figure 1)	$R_L = 10$ kΩ, $C_L = 100$ pF	25°C	2.6	3.4		V/μs
		Full range	2.1			
$V_n$ Equivalent input noise voltage (see Figure 2)	$f = 10$ Hz, $R_S = 20$ Ω	25°C		70	100	nV/√Hz
	$f = 1$ kHz, $R_S = 20$ Ω	25°C		40	60	
$V_{N(PP)}$ Peak-to-peak equivalent input noise voltage	$f = 0.1$ Hz to 10 Hz	25°C		1.1		μV
$I_n$ Equivalent input noise current	$f = 1$ kHz	25°C		1.1		fA/√Hz
THD Total harmonic distortion	$V_{O(PP)} = 2$ V, $R_L = 10$ kΩ, $A_{VD} = 2$ , $f = 10$ kHz	25°C		0.025%		
$B_1$ Unity-gain bandwidth (see Figure 3)	$R_L = 10$ kΩ, $C_L = 100$ pF	25°C		2		MHz
	$R_L = 600$ Ω, $C_L = 100$ pF	25°C		1.5		
Settling time	0.1%	25°C		5		μs
	0.01%	25°C		10		
BOM Maximum output-swing bandwidth	$A_{VD} = 1$ , $R_L = 10$ kΩ	25°C		40		kHz
$\phi_m$ Phase margin at unity gain (see Figure 3)	$R_L = 10$ kΩ, $C_L = 100$ pF	25°C		60°		
	$R_L = 600$ Ω, $C_L = 100$ pF	25°C		70°		

† Full range is –40°C to 85°C.

**TLE206x, TLE206xA, TLE206xB**  
**EXCALIBUR JFET-INPUT HIGH-OUTPUT-DRIVE**  
**μPOWER OPERATIONAL AMPLIFIERS**

SLOS193B – FEBRUARY 1997 – REVISED MAY 2004

**TLE2062M electrical characteristics at specified free-air temperature,  $V_{CC\pm} = \pm 5\text{ V}$**

PARAMETER		TEST CONDITIONS	$T_A$ †	TLE2062M TLE2062AM TLE2062BM			UNIT
				MIN	TYP	MAX	
$V_{IO}$	Input offset voltage	$V_{IC} = 0, \quad R_S = 50\ \Omega$	25°C	1	5	mV	
			Full range	7			
			25°C	0.9	4		
	Full range		6				
	25°C		0.7	3			
	Full range		5				
	$\alpha_{VIO}$		Temperature coefficient of input offset voltage	Full range	6		$\mu\text{V}/^\circ\text{C}$
			Input offset voltage long-term drift (see Note 4)	25°C	0.04		$\mu\text{V}/\text{mo}$
	$I_{IO}$		Input offset current	25°C	1		pA
$I_{IB}$	Input bias current	Full range	15		nA		
		25°C	3		pA		
$V_{ICR}$	Common-mode input voltage range	25°C	-1.6 to 4	-2 to 6	V		
		Full range	-1.6 to 4		V		
$V_{OM+}$	Maximum positive peak output voltage swing	$R_L = 10\ \text{k}\Omega$	25°C	3.5	3.7	V	
			Full range	3			
		FK and JG packages	$R_L = 600\ \Omega$	25°C	2.5		3.6
				Full range	2		
		D and P packages	$R_L = 100\ \Omega$	25°C	2.5		3.1
				Full range	2		
$V_{OM-}$	Maximum negative peak output voltage swing	$R_L = 10\ \text{k}\Omega$	25°C	-3.5	-3.9	V	
			Full range	-3			
		FK and JG packages	$R_L = 600\ \Omega$	25°C	-2.5		-3.5
				Full range	-2		
		D and P packages	$R_L = 100\ \Omega$	25°C	-2.5		-2.7
				Full range	-2		
$A_{VD}$	Large-signal differential voltage amplification	$V_O = \pm 2.8\ \text{V}, \quad R_L = 10\ \text{k}\Omega$	25°C	15	80	V/mV	
			Full range	2			
		FK and JG packages	$V_O = 0\ \text{to}\ 2.5\ \text{V}, \quad R_L = 600\ \Omega$	25°C	1		65
				Full range	0.5		
			$V_O = 0\ \text{to}\ -2.5\ \text{V}, \quad R_L = 600\ \Omega$	25°C	1		16
				Full range	0.5		
		D and P packages	$V_O = 0\ \text{to}\ 2\ \text{V}, \quad R_L = 100\ \Omega$	25°C	0.75		45
				Full range	0.5		
			$V_O = 0\ \text{to}\ -2\ \text{V}, \quad R_L = 100\ \Omega$	25°C	0.5		3
				Full range	0.25		

† Full range is  $-55^\circ\text{C}$  to  $125^\circ\text{C}$ .

NOTE 4: Typical values are based on the input offset voltage shift observed through 168 hours of operating life test at  $T_A = 150^\circ\text{C}$  extrapolated to  $T_A = 25^\circ\text{C}$  using the Arrhenius equation and assuming an activation energy of 0.96 eV.



**TLE206x, TLE206xA, TLE206xB**  
**EXCALIBUR JFET-INPUT HIGH-OUTPUT-DRIVE**  
**μPOWER OPERATIONAL AMPLIFIERS**

SLOS193B – FEBRUARY 1997 – REVISED MAY 2004

**TLE2062M electrical characteristics at specified free-air temperature,  $V_{CC\pm} = \pm 5\text{ V}$  (unless otherwise noted)**

PARAMETER	TEST CONDITIONS	$T_A$ †	TLE2062M TLE2062AM TLE2062BM			UNIT
			MIN	TYP	MAX	
$r_i$ Input resistance		25°C	10 <sup>12</sup>			Ω
$c_i$ Input capacitance		25°C	4			pF
$z_o$ Open-loop output impedance	$I_O = 0$	25°C	560			Ω
CMRR Common-mode rejection ratio	$V_{IC} = V_{ICRmin}$ $R_S = 50\ \Omega$	25°C	65	82		dB
		Full range	60			
$k_{SVR}$ Supply-voltage rejection ratio ( $\Delta V_{CC\pm}/\Delta V_{IO}$ )	$V_{CC\pm} = \pm 5\text{ V to } \pm 15\text{ V}$ , $R_S = 50\ \Omega$	25°C	75	93		dB
		Full range	65			
$I_{CC}$ Supply current (two amplifiers)	$V_O = 0$ , No load	25°C	560	620		μA
		Full range		650		
$\Delta I_{CC}$ Supply-current change over operating temperature range (two amplifiers)		Full range	72			μA

† Full range is -55°C to 125°C.

**TLE2062M operating characteristics at specified free-air temperature,  $T_A = 25^\circ\text{C}$ ,  $V_{CC\pm} = \pm 5\text{ V}$**

PARAMETER	TEST CONDITIONS	TLE2062M TLE2062AM TLE2062BM			UNIT
		MIN	TYP	MAX	
SR Slew rate at unity gain (see Figure 1)	$R_L = 10\text{ k}\Omega$ , $C_L = 100\text{ pF}$	3.4			V/μs
$V_n$ Equivalent input noise voltage (see Figure 2)	$f = 10\text{ Hz}$ , $R_S = 20\ \Omega$	59			nV/√Hz
	$f = 1\text{ kHz}$ , $R_S = 20\ \Omega$	43			
$V_N(PP)$ Peak-to-peak equivalent input noise voltage	$f = 0.1\text{ Hz to } 10\text{ Hz}$	1.1			μV
$I_n$ Equivalent input noise current	$f = 1\text{ kHz}$	1			fA/√Hz
THD Total harmonic distortion	$V_{O(PP)} = 2\text{ V}$ , $R_L = 10\text{ k}\Omega$ , $A_{VD} = 2$ , $f = 10\text{ kHz}$	0.025%			
$B_1$ Unity-gain bandwidth (see Figure 3)	$R_L = 10\text{ k}\Omega$ , $C_L = 100\text{ pF}$	1.8			MHz
	$R_L = 600\ \Omega$ , $C_L = 100\text{ pF}$	1.3			
Settling time	0.1%	5			μs
	0.01%	10			
$B_{OM}$ Maximum output-swing bandwidth	$A_{VD} = 1$ , $R_L = 10\text{ k}\Omega$	140			kHz
$\phi_m$ Phase margin at unity gain (see Figure 3)	$R_L = 10\text{ k}\Omega$ , $C_L = 100\text{ pF}$	58°			
	$R_L = 600\ \Omega$ , $C_L = 100\text{ pF}$	75°			



**TLE206x, TLE206xA, TLE206xB**  
**EXCALIBUR JFET-INPUT HIGH-OUTPUT-DRIVE**  
**μPOWER OPERATIONAL AMPLIFIERS**

SLOS193B – FEBRUARY 1997 – REVISED MAY 2004

**TLE2062M electrical characteristics at specified free-air temperature,  $V_{CC\pm} = \pm 15\text{ V}$  (unless otherwise noted)**

PARAMETER		TEST CONDITIONS	$T_A$ †	TLE2062M TLE2062AM TLE2062BM			UNIT
				MIN	TYP	MAX	
$V_{IO}$	Input offset voltage	$V_{IC} = 0, R_S = 50\ \Omega$	25°C	0.9	4	mV	
			Full range	6			
			25°C	0.8	2		
			Full range	4			
			25°C	0.5	1		
			Full range	3			
$\alpha_{VIO}$	Temperature coefficient of input offset voltage	$V_{IC} = 0, R_S = 50\ \Omega$	Full range	6		$\mu\text{V}/^\circ\text{C}$	
	Input offset voltage long-term drift (see Note 4)		25°C	0.04		$\mu\text{V}/\text{mo}$	
$I_{IO}$	Input offset current		25°C	2		pA	
			Full range	20		nA	
$I_{IB}$	Input bias current		25°C	4		pA	
			Full range	40		nA	
$V_{ICR}$	Common-mode input voltage range	25°C	-11 to 13	-12 to 16	V		
		Full range	-11 to 13		V		
$V_{OM+}$	Maximum positive peak output voltage swing	$R_L = 10\ \text{k}\Omega$	25°C	13	13.7	V	
			Full range	12.5			
		$R_L = 600\ \Omega$	25°C	12.5	13.2		
			Full range	11			
$V_{OM-}$	Maximum negative peak output voltage swing	$R_L = 10\ \text{k}\Omega$	25°C	-13	-13.7	V	
			Full range	-12.5			
		$R_L = 600\ \Omega$	25°C	-12.5	-13		
			Full range	-11			
$A_{VD}$	Large-signal differential voltage amplification	$V_O = \pm 10\ \text{V}, R_L = 10\ \text{k}\Omega$	25°C	30	230	V/mV	
			Full range	20			
		$V_O = 0\ \text{to}\ 8\ \text{V}, R_L = 600\ \Omega$	25°C	25	100		
			Full range	7			
		$V_O = 0\ \text{to}\ -8\ \text{V}, R_L = 600\ \Omega$	25°C	3	25		
			Full range	1			
$r_i$	Input resistance		25°C	$10^{12}$		$\Omega$	
$c_i$	Input capacitance		25°C	4		pF	
$z_o$	Open-loop output impedance	$I_O = 0$	25°C	560		$\Omega$	
CMRR	Common-mode rejection ratio	$V_{IC} = V_{ICR\text{min}}, R_S = 50\ \Omega$	25°C	72	90	dB	
			Full range	65			
$k_{SVR}$	Supply-voltage rejection ratio ( $\Delta V_{CC\pm}/\Delta V_{IO}$ )	$V_{CC\pm} = \pm 5\ \text{V to } \pm 15\ \text{V}, R_S = 50\ \Omega$	25°C	75	93	dB	
			Full range	65			

† Full range is  $-55^\circ\text{C}$  to  $125^\circ\text{C}$ .

NOTE 4: Typical values are based on the input offset voltage shift observed through 168 hours of operating life test at  $T_A = 150^\circ\text{C}$  extrapolated to  $T_A = 25^\circ\text{C}$  using the Arrhenius equation and assuming an activation energy of 0.96 eV.



**TLE206x, TLE206xA, TLE206xB**  
**EXCALIBUR JFET-INPUT HIGH-OUTPUT-DRIVE**  
**μPOWER OPERATIONAL AMPLIFIERS**

SLOS193B – FEBRUARY 1997 – REVISED MAY 2004

**TLE2062M electrical characteristics at specified free-air temperature,  $V_{CC\pm} = \pm 15$  V (unless otherwise noted)**

PARAMETER	TEST CONDITIONS	$T_A$ †	TLE2062M TLE2062AM TLE2062BM			UNIT
			MIN	TYP	MAX	
$I_{CC}$ Supply current	$V_O = 0$ , No load	25°C		625	690	$\mu A$
		Full range			730	
$\Delta I_{CC}$ Supply-current change over operating temperature range		Full range		97		$\mu A$

† Full range is –55°C to 125°C.

**TLE2062M operating characteristics at specified free-air temperature,  $V_{CC\pm} = \pm 15$  V**

PARAMETER	TEST CONDITIONS	$T_A$ †	TLE2062M TLE2062AM TLE2062BM			UNIT
			MIN	TYP	MAX	
SR Slew rate at unity gain (see Figure 1)	$R_L = 10$ k $\Omega$ , $C_L = 100$ pF	25°C	2	3.4		V/ $\mu s$
		Full range	1.8			
$V_n$ Equivalent input noise voltage (see Figure 2)	$f = 10$ Hz, $R_S = 20$ $\Omega$	25°C		70		nV/ $\sqrt{Hz}$
	$f = 1$ kHz, $R_S = 20$ $\Omega$	25°C		40		
$V_{N(PP)}$ Peak-to-peak equivalent input noise voltage	$f = 0.1$ Hz to 10 Hz	25°C		1.1		$\mu V$
$I_n$ Equivalent input noise current	$f = 1$ kHz	25°C		1.1		fA/ $\sqrt{Hz}$
THD Total harmonic distortion	$V_{O(PP)} = 2$ V, $R_L = 10$ k $\Omega$ , $A_{VD} = 2$ , $f = 10$ kHz	25°C		0.025%		
$B_1$ Unity-gain bandwidth (see Figure 3)	$R_L = 10$ k $\Omega$ , $C_L = 100$ pF	25°C		2		MHz
	$R_L = 600$ $\Omega$ , $C_L = 100$ pF	25°C		1.5		
Settling time	0.1%	25°C		5		$\mu s$
	0.01%	25°C		10		
$B_{OM}$ Maximum output-swing bandwidth	$A_{VD} = 1$ , $R_L = 10$ k $\Omega$	25°C		40		kHz
$\phi_m$ Phase margin at unity gain (see Figure 3)	$R_L = 10$ k $\Omega$ , $C_L = 100$ pF	25°C		60°		
	$R_L = 600$ $\Omega$ , $C_L = 100$ pF	25°C		70°		

† Full range is –55°C to 125°C.



**TLE206x, TLE206xA, TLE206xB**  
**EXCALIBUR JFET-INPUT HIGH-OUTPUT-DRIVE**  
**μPOWER OPERATIONAL AMPLIFIERS**

SLOS193B – FEBRUARY 1997 – REVISED MAY 2004

**TLE2062Y electrical characteristics at  $V_{CC\pm} = \pm 15\text{ V}$ ,  $T_A = 25^\circ\text{C}$  (unless otherwise noted)**

PARAMETER	TEST CONDITIONS	TLE2062Y			UNIT
		MIN	TYP	MAX	
$V_{IO}$ Input offset voltage	$V_{IC} = 0$ , $R_S = 50\ \Omega$		0.9	4	mV
$\alpha V_{IO}$ Input offset voltage long-term drift (see Note 4)			0.04		$\mu\text{V}/\text{mo}$
$I_{IO}$ Input offset current			2		pA
$I_{IB}$ Input bias current			4		pA
$V_{ICR}$ Common-mode input voltage range		-11 to 13	-12 to 16		V
$V_{OM+}$ Maximum positive peak output voltage swing	$R_L = 10\ \text{k}\Omega$	13.2	13.7		V
	$R_L = 600\ \Omega$	12.5	13.2		
$V_{OM-}$ Maximum negative peak output voltage swing	$R_L = 10\ \text{k}\Omega$	-13.2	-13.7		V
	$R_L = 600\ \Omega$	-12.5	-13		
$A_{VD}$ Large-signal differential voltage amplification	$V_O = \pm 10\ \text{V}$ , $R_L = 10\ \text{k}\Omega$	30	230		V/mV
	$V_O = 0$ to $8\ \text{V}$ , $R_L = 600\ \Omega$	25	100		
	$V_O = 0$ to $-8\ \text{V}$ , $R_L = 600\ \Omega$	3	25		
$r_i$ Input resistance			$10^{12}$		$\Omega$
$c_i$ Input capacitance			4		pF
$z_o$ Open-loop output impedance	$I_O = 0$		560		$\Omega$
CMRR Common-mode rejection ratio	$V_{IC} = V_{ICR\text{min}}$ , $R_S = 50\ \Omega$	72	90		dB
$k_{SVR}$ Supply-voltage rejection ratio ( $\Delta V_{CC}/\Delta V_{IO}$ )	$V_{CC\pm} = \pm 5\ \text{V}$ to $\pm 15\ \text{V}$ , $R_S = 50\ \Omega$	75	93		dB
$I_{CC}$ Supply current	$V_O = 0$ , No load		625	690	$\mu\text{A}$

NOTE 4: Typical values are based on the input offset voltage shift observed through 168 hours of operating life test at  $T_A = 150^\circ\text{C}$  extrapolated to  $T_A = 25^\circ\text{C}$  using the Arrhenius equation and assuming an activation energy of 0.96 eV.

**TLE2062Y operating characteristics at  $V_{CC\pm} = \pm 15\ \text{V}$ ,  $T_A = 25^\circ\text{C}$**

PARAMETER	TEST CONDITIONS	TLE2062Y			UNIT
		MIN	TYP	MAX	
SR Slew rate at unity gain (see Figure 1)	$R_L = 10\ \text{k}\Omega$ , $C_L = 100\ \text{pF}$	2.6	3.4	4	$\text{V}/\mu\text{s}$
$V_n$ Equivalent input noise voltage (see Figure 2)	$f = 10\ \text{Hz}$ , $R_S = 20\ \Omega$		70		$\text{nV}/\sqrt{\text{Hz}}$
	$f = 1\ \text{kHz}$ , $R_S = 20\ \Omega$		40		
$V_{N(PP)}$ Peak-to-peak equivalent input noise voltage	$f = 0.1\ \text{Hz}$ to $10\ \text{Hz}$		1.1		$\mu\text{V}$
$I_n$ Equivalent input noise current	$f = 1\ \text{Hz}$		1.1		$\text{fA}/\sqrt{\text{Hz}}$
THD Total harmonic distortion	$V_{O(PP)} = 2\ \text{V}$ , $R_L = 10\ \text{k}\Omega$ , $A_{VD} = 2$ , $f = 10\ \text{kHz}$		0.025%		
$B_1$ Unity-gain bandwidth (see Figure 3)	$R_L = 10\ \text{k}\Omega$ , $C_L = 100\ \text{pF}$		2		MHz
	$R_L = 600\ \Omega$ , $C_L = 100\ \text{pF}$		1.5		
Settling time	0.1%		5		$\mu\text{s}$
	0.01%		10		
$B_{OM}$ Maximum output-swing bandwidth	$A_{VD} = 1$ , $R_L = 10\ \text{k}\Omega$		40		kHz
$\phi_m$ Phase margin at unity gain (see Figure 3)	$R_L = 10\ \text{k}\Omega$ , $C_L = 100\ \text{pF}$		60°		
	$R_L = 600\ \Omega$ , $C_L = 100\ \text{pF}$		70°		



**TLE206x, TLE206xA, TLE206xB**  
**EXCALIBUR JFET-INPUT HIGH-OUTPUT-DRIVE**  
**μPOWER OPERATIONAL AMPLIFIERS**

SLOS193B – FEBRUARY 1997 – REVISED MAY 2004

**TLE2064C electrical characteristics at specified free-air temperature,  $V_{CC\pm} = \pm 5\text{ V}$  (unless otherwise noted)**

PARAMETER		TEST CONDITIONS	$T_A$ †	TLE2064C TLE2064AC TLE2064BC			UNIT
				MIN	TYP	MAX	
$V_{IO}$	Input offset voltage	$V_{IC} = 0, R_S = 50\ \Omega$	25°C	1.2	7	mV	
			Full range	7.9			
			25°C	1.2	6		
			Full range	6.9			
$\alpha_{VIO}$	Temperature coefficient of input offset voltage	$V_{IC} = 0, R_S = 50\ \Omega$	25°C	0.8	3.5	$\mu\text{V}/^\circ\text{C}$	
			Full range	4.4			
Input offset voltage long-term drift (see Note 4)		$V_{IC} = 0, R_S = 50\ \Omega$	25°C	6		$\mu\text{V}/\text{mo}$	
			Full range	0.04			
$I_{IO}$	Input offset current	$V_{IC} = 0, R_S = 50\ \Omega$	25°C	1		pA	
			Full range	0.8		nA	
$I_{IB}$	Input bias current	$V_{IC} = 0, R_S = 50\ \Omega$	25°C	3		pA	
			Full range	2		nA	
$V_{ICR}$	Common-mode input voltage range		25°C	-1.6 to 4	-2 to 6	V	
			Full range	-1.6 to 4		V	
$V_{OM+}$	Maximum positive peak output voltage swing	$R_L = 10\ \text{k}\Omega$	25°C	3.5	3.7	V	
			Full range	3.3			
		$R_L = 100\ \Omega$	25°C	2.5	3.1		
			Full range	2			
$V_{OM-}$	Maximum negative peak output voltage swing	$R_L = 10\ \text{k}\Omega$	25°C	-3.7	-3.9	V	
			Full range	-3.3			
		$R_L = 100\ \Omega$	25°C	-2.5	-2.7		
			Full range	-2			
$A_{VD}$	Large-signal differential voltage amplification	$V_O = \pm 2.8\ \text{V}, R_L = 10\ \text{k}\Omega$	25°C	15	80	V/mV	
			Full range	2			
		$V_O = 0\ \text{to}\ 2\ \text{V}, R_L = 100\ \Omega$	25°C	0.75	45		
			Full range	0.5			
		$V_O = 0\ \text{to}\ -2\ \text{V}, R_L = 100\ \Omega$	25°C	0.5	3		
			Full range	0.15			
$r_i$	Input resistance		25°C	$10^{12}$		$\Omega$	
$c_i$	Input capacitance		25°C	4		pF	
$z_o$	Open-loop output impedance	$I_O = 0$	25°C	560		$\Omega$	
CMRR	Common-mode rejection ratio	$V_{IC} = V_{ICRmin}, R_S = 50\ \Omega$	25°C	65	82	dB	
			Full range	65			
$k_{SVR}$	Supply-voltage rejection ratio ( $\Delta V_{CC\pm} / \Delta V_{IO}$ )	$V_{CC\pm} = \pm 5\ \text{V}\ \text{to}\ \pm 15\ \text{V}, R_S = 50\ \Omega$	25°C	75	93	dB	
			Full range	75			

† Full range is 0°C to 70°C.

NOTE 4: Typical values are based on the input offset voltage shift observed through 168 hours of operating life test at  $T_A = 150^\circ\text{C}$  extrapolated to  $T_A = 25^\circ\text{C}$  using the Arrhenius equation and assuming an activation energy of 0.96 eV.





**TLE206x, TLE206xA, TLE206xB**  
**EXCALIBUR JFET-INPUT HIGH-OUTPUT-DRIVE**  
**μPOWER OPERATIONAL AMPLIFIERS**

SLOS193B – FEBRUARY 1997 – REVISED MAY 2004

**TLE2064C electrical characteristics at specified free-air temperature,  $V_{CC\pm} = \pm 5\text{ V}$  (unless otherwise noted) (continued)**

PARAMETER	TEST CONDITIONS	$T_A$ †	TLE2064C TLE2064AC TLE2064BC			UNIT
			MIN	TYP	MAX	
$I_{CC}$ Supply current (four amplifiers)	$V_O = 0$ , No load	25°C		1.12	1.3	mA
		Full range			1.3	
$\Delta I_{CC}$ Supply-current change over operating temperature range (four amplifiers)		Full range		52		μA
$V_{O1}/V_{O2}$ Crosstalk attenuation	$A_{VD} = 1000$ , $f = 1\text{ kHz}$	25°C		120		dB

† Full range is 0°C to 70°C.

**TLE2064C operating characteristics at specified free-air temperature,  $V_{CC\pm} = \pm 5\text{ V}$**

PARAMETER	TEST CONDITIONS	$T_A$ †	TLE2064C TLE2064AC TLE2064BC			UNIT
			MIN	TYP	MAX	
SR Slew rate at unity gain (see Figure 1)	$R_L = 10\text{ k}\Omega$ , $C_L = 100\text{ pF}$	25°C		2.2	3.4	V/μs
		Full range		2.1		
$V_n$ Equivalent input noise voltage (see Figure 2)	$f = 10\text{ Hz}$ , $R_S = 20\ \Omega$	25°C		59	100	nV/√Hz
	$f = 1\text{ kHz}$ , $R_S = 20\ \Omega$			43	60	
$V_{N(PP)}$ Peak-to-peak equivalent input noise voltage	$f = 0.1\text{ Hz to }10\text{ Hz}$	25°C		1.1		μV
$I_n$ Equivalent input noise current	$f = 1\text{ kHz}$	25°C		1		fA/√Hz
THD Total harmonic distortion	$A_{VD} = 2$ , $f = 10\text{ kHz}$ , $V_{O(PP)} = 2\text{ V}$ , $R_L = 10\text{ k}\Omega$	25°C		0.025%		
$B_1$ Unity-gain bandwidth (see Figure 3)	$R_L = 10\text{ k}\Omega$ , $C_L = 100\text{ pF}$	25°C		1.8		MHz
	$R_L = 100\ \Omega$ , $C_L = 100\text{ pF}$			1.3		
$t_s$ Settling time	$\epsilon = 0.1\%$	25°C		5		μs
	$\epsilon = 0.01\%$			10		
$B_{OM}$ Maximum output-swing bandwidth	$A_{VD} = 1$ , $R_L = 10\text{ k}\Omega$	25°C		140		kHz
$\phi_m$ Phase margin at unity gain (see Figure 3)	$R_L = 10\text{ k}\Omega$ , $C_L = 100\text{ pF}$	25°C		58°		
	$R_L = 100\ \Omega$ , $C_L = 100\text{ pF}$			75°		

† Full range is 0°C to 70°C.

**TLE206x, TLE206xA, TLE206xB**  
**EXCALIBUR JFET-INPUT HIGH-OUTPUT-DRIVE**  
**μPOWER OPERATIONAL AMPLIFIERS**

SLOS193B – FEBRUARY 1997 – REVISED MAY 2004

**TLE2064C electrical characteristics at specified free-air temperature,  $V_{CC\pm} = \pm 15\text{ V}$  (unless otherwise noted)**

PARAMETER		TEST CONDITIONS	T <sub>A</sub> †	TLE2064C TLE2064AC TLE2064BC			UNIT
				MIN	TYP	MAX	
V <sub>IO</sub>	Input offset voltage	V <sub>IC</sub> = 0, R <sub>S</sub> = 50 Ω	25°C	0.9	6	mV	
			Full range	6.9			
			25°C	0.9	4		
			Full range	4.9			
			25°C	0.7	2		
			Full range	4			
α <sub>VIO</sub>	Temperature coefficient of input offset voltage	V <sub>IC</sub> = 0, R <sub>S</sub> = 50 Ω	25°C	6		μV/°C	
Input offset voltage long-term drift (see Note 4)			Full range	0.04		μV/mo	
I <sub>IO</sub>	Input offset current		25°C	2		pA	
			Full range	1		nA	
I <sub>IB</sub>	Input bias current		25°C	4		pA	
			Full range	3		nA	
V <sub>ICR</sub>	Common-mode input voltage range		25°C	-11 to 13	-12 to 16	V	
			Full range	-11 to 13		V	
V <sub>OM+</sub>	Maximum positive peak output voltage swing	R <sub>L</sub> = 10 kΩ	25°C	13.2	13.7	V	
			Full range	13			
		R <sub>L</sub> = 600 Ω	25°C	12.5	13.2		
			Full range	12			
V <sub>OM-</sub>	Maximum negative peak output voltage swing	R <sub>L</sub> = 10 kΩ	25°C	-13.2	-13.7	V	
			Full range	-13			
		R <sub>L</sub> = 600 Ω	25°C	-12.5	-13		
			Full range	-12			
A <sub>VD</sub>	Large-signal differential voltage amplification	V <sub>O</sub> = ±10 V, R <sub>L</sub> = 10 kΩ	25°C	30	230	V/mV	
			Full range	20			
		V <sub>O</sub> = 0 to 8 V, R <sub>L</sub> = 600 Ω	25°C	25	100		
			Full range	10			
		V <sub>O</sub> = 0 to -8 V, R <sub>L</sub> = 600 Ω	25°C	3	25		
			Full range	1			
r <sub>i</sub>	Input resistance		25°C	10 <sup>12</sup>		Ω	
c <sub>i</sub>	Input capacitance		25°C	4		pF	
z <sub>o</sub>	Open-loop output impedance	I <sub>O</sub> = 0	25°C	560		Ω	
CMRR	Common-mode rejection ratio	V <sub>IC</sub> = V <sub>ICRmin</sub> , R <sub>S</sub> = 50 Ω	25°C	72	90	dB	
			Full range	70			
k <sub>SVR</sub>	Supply-voltage rejection ratio (ΔV <sub>CC±</sub> /ΔV <sub>IO</sub> )	V <sub>CC±</sub> = ±5 V to ±15 V, R <sub>S</sub> = 50 Ω	25°C	75	93	dB	
			Full range	75			

† Full range is 0°C to 70°C.

NOTE 4: Typical values are based on the input offset voltage shift observed through 168 hours of operating life test at T<sub>A</sub> = 150°C extrapolated to T<sub>A</sub> = 25°C using the Arrhenius equation and assuming an activation energy of 0.96 eV.



**TLE206x, TLE206xA, TLE206xB**  
**EXCALIBUR JFET-INPUT HIGH-OUTPUT-DRIVE**  
**μPOWER OPERATIONAL AMPLIFIERS**

SLOS193B – FEBRUARY 1997 – REVISED MAY 2004

**TLE2064C electrical characteristics at specified free-air temperature,  $V_{CC\pm} = \pm 15\text{ V}$  (unless otherwise noted) (continued)**

PARAMETER	TEST CONDITIONS	$T_A$ †	TLE2064C TLE2064AC TLE2064BC			UNIT
			MIN	TYP	MAX	
$I_{CC}$ Supply current (four amplifiers)	$V_O = 0$ , No load	25°C	1.25	1.4	mA	
		Full range	1.5			
$\Delta I_{CC}$ Supply-current change over operating temperature range (four amplifiers)		Full range	72		μA	
$V_{O1}/V_{O2}$ Crosstalk attenuation	$A_{VD} = 1000$ , $f = 1\text{ kHz}$	25°C	120		dB	

† Full range is 0°C to 70°C.

**TLE2064C operating characteristics at specified free-air temperature,  $V_{CC\pm} = \pm 15\text{ V}$**

PARAMETER	TEST CONDITIONS	$T_A$ †	TLE2064C TLE2064AC TLE2064BC			UNIT
			MIN	TYP	MAX	
SR Slew rate at unity gain (see Figure 1)	$R_L = 10\text{ k}\Omega$ , $C_L = 100\text{ pF}$	25°C	2.6	3.4	V/μs	
		Full range	2.5			
$V_n$ Equivalent input noise voltage (see Figure 2)	$f = 10\text{ Hz}$ , $R_S = 20\ \Omega$	25°C	70		nV/√Hz	
	$f = 1\text{ kHz}$ , $R_S = 20\ \Omega$		40			
$V_{N(PP)}$ Peak-to-peak equivalent input noise voltage	$f = 0.1\text{ Hz to }10\text{ Hz}$	25°C	1.1		μV	
$I_n$ Equivalent input noise current	$f = 1\text{ kHz}$	25°C	1		fA/√Hz	
THD Total harmonic distortion	$A_{VD} = 2$ , $V_{O(PP)} = 2\text{ V}$ , $f = 10\text{ kHz}$ , $R_L = 10\text{ k}\Omega$	25°C	0.025%			
$B_1$ Unity-gain bandwidth (see Figure 3)	$R_L = 10\text{ k}\Omega$ , $C_L = 100\text{ pF}$	25°C	2		MHz	
	$R_L = 600\ \Omega$ , $C_L = 100\text{ pF}$		1.5			
$t_s$ Settling time	$\epsilon = 0.1\%$	25°C	5		μs	
	$\epsilon = 0.01\%$		10			
$B_{OM}$ Maximum output-swing bandwidth	$A_{VD} = 1$ , $R_L = 10\text{ k}\Omega$	25°C	40		kHz	
$\phi_m$ Phase margin at unity gain (see Figure 3)	$R_L = 10\text{ k}\Omega$ , $C_L = 100\text{ pF}$	25°C	50°			
	$R_L = 600\ \Omega$ , $C_L = 100\text{ pF}$		70°			

† Full range is 0°C to 70°C.



**TLE206x, TLE206xA, TLE206xB**  
**EXCALIBUR JFET-INPUT HIGH-OUTPUT-DRIVE**  
**μPOWER OPERATIONAL AMPLIFIERS**

SLOS193B – FEBRUARY 1997 – REVISED MAY 2004

**TLE2064I electrical characteristics at specified free-air temperature,  $V_{CC\pm} = \pm 5\text{ V}$  (unless otherwise noted)**

PARAMETER		TEST CONDITIONS	$T_A$ †	TLE2064I TLE2064AI TLE2064BI			UNIT
				MIN	TYP	MAX	
$V_{IO}$	Input offset voltage	$V_{IC} = 0,$ $R_S = 50\ \Omega$	25°C	1.2	7	mV	
			Full range	8.3			
			25°C	1.2	6		
			Full range	7.3			
$\alpha_{VIO}$	Temperature coefficient of input offset voltage	$V_{IC} = 0,$ $R_S = 50\ \Omega$	25°C	0.8	3.5	$\mu\text{V}/^\circ\text{C}$	
			Full range	4.8			
Input offset voltage long-term drift (see Note 4)		$V_{IC} = 0,$ $R_S = 50\ \Omega$	25°C	6		$\mu\text{V}/\text{mo}$	
			Full range	0.04			
$I_{IO}$	Input offset current	$V_{IC} = 0,$ $R_S = 50\ \Omega$	25°C	1		pA	
			Full range	2		nA	
$I_{IB}$	Input bias current	$V_{IC} = 0,$ $R_S = 50\ \Omega$	25°C	3		pA	
			Full range	4		nA	
$V_{ICR}$	Common-mode input voltage range		25°C	-1.6 to 4	-2 to 6	V	
			Full range	-1.6 to 4		V	
$V_{OM+}$	Maximum positive peak output voltage swing	$R_L = 10\ \text{k}\Omega$	25°C	3.5	3.7	V	
			Full range	3.1			
$V_{OM-}$	Maximum negative peak output voltage swing	$R_L = 100\ \Omega$	25°C	2.5	3.1	V	
			Full range	2			
$V_{OM-}$	Maximum negative peak output voltage swing	$R_L = 10\ \text{k}\Omega$	25°C	-3.7	-3.9	V	
			Full range	-3.1			
$V_{OM-}$	Maximum negative peak output voltage swing	$R_L = 100\ \Omega$	25°C	-2.5	-2.7	V	
			Full range	-2			
$A_{VD}$	Large-signal differential voltage amplification	$V_O = \pm 2.8\ \text{V},$ $R_L = 10\ \text{k}\Omega$	25°C	15	80	V/mV	
			Full range	2			
		$V_O = 0\ \text{to}\ 2\ \text{V},$ $R_L = 100\ \Omega$	25°C	0.75	45		
			Full range	0.5			
		$V_O = 0\ \text{to}\ -2\ \text{V},$ $R_L = 100\ \Omega$	25°C	0.5	3		
			Full range	0.15			
$r_i$	Input resistance		25°C	$10^{12}$		$\Omega$	
$c_i$	Input capacitance		25°C	4		pF	
$z_o$	Open-loop output impedance	$I_O = 0$	25°C	560		$\Omega$	
CMRR	Common-mode rejection ratio	$V_{IC} = V_{ICR\text{min}},$ $R_S = 50\ \Omega$	25°C	65	82	dB	
			Full range	65			
$k_{SVR}$	Supply-voltage rejection ratio ( $\Delta V_{CC\pm} / \Delta V_{IO}$ )	$V_{CC\pm} = \pm 5\ \text{V}\ \text{to}\ \pm 15\ \text{V},$ $R_S = 50\ \Omega$	25°C	75	93	dB	
			Full range	65			

† Full range is -40°C to 85°C.

NOTE 4: Typical values are based on the input offset voltage shift observed through 168 hours of operating life test at  $T_A = 150^\circ\text{C}$  extrapolated to  $T_A = 25^\circ\text{C}$  using the Arrhenius equation and assuming an activation energy of 0.96 eV.



**TLE206x, TLE206xA, TLE206xB**  
**EXCALIBUR JFET-INPUT HIGH-OUTPUT-DRIVE**  
**μPOWER OPERATIONAL AMPLIFIERS**

SLOS193B – FEBRUARY 1997 – REVISED MAY 2004

**TLE2064I electrical characteristics at specified free-air temperature,  $V_{CC\pm} = \pm 5\text{ V}$  (unless otherwise noted) (continued)**

PARAMETER	TEST CONDITIONS	$T_A^\dagger$	TLE2064I TLE2064AI TLE2064BI			UNIT
			MIN	TYP	MAX	
$I_{CC}$ Supply current (four amplifiers)	$V_O = 0$ , No load	25°C	1.12	1.3	mA	
		Full range	1.3			
$\Delta I_{CC}$ Supply-current change over operating temperature range (four amplifiers)		Full range	108		μA	
$V_{O1}/V_{O2}$ Crosstalk attenuation	$A_{VD} = 1000$ , $f = 1\text{ kHz}$	25°C	120		dB	

† Full range is  $-40^\circ\text{C}$  to  $85^\circ\text{C}$ .

**TLE2064I operating characteristics at specified free-air temperature,  $V_{CC\pm} = \pm 5\text{ V}$  (unless otherwise noted)**

PARAMETER	TEST CONDITIONS	$T_A^\dagger$	TLE2064I TLE2064AI TLE2064BI			UNIT
			MIN	TYP	MAX	
SR Slew rate at unity gain (see Figure 1)	$R_L = 10\text{ k}\Omega$ , $C_L = 100\text{ pF}$	25°C	2.2	3.4	V/μs	
		Full range	1.7			
$V_n$ Equivalent input noise voltage (see Figure 2)	$f = 10\text{ Hz}$ , $R_S = 20\ \Omega$	25°C	59		nV/√Hz	
	$f = 1\text{ kHz}$ , $f = 1\text{ kHz}$		43			
$V_{N(PP)}$ Peak-to-peak equivalent input noise voltage	$f = 0.1\text{ Hz}$ to $10\text{ Hz}$	25°C	1.1		μV	
$I_n$ Equivalent input noise current	$f = 1\text{ kHz}$	25°C	1		fA/√Hz	
THD Total harmonic distortion	$A_{VD} = 2$ , $f = 10\text{ kHz}$ , $V_{O(PP)} = 2\text{ V}$ , $R_L = 10\text{ k}\Omega$	25°C	0.025%			
$B_1$ Unity-gain bandwidth (see Figure 3)	$R_L = 10\text{ k}\Omega$ , $C_L = 100\text{ pF}$	25°C	1.8		MHz	
	$R_L = 100\ \Omega$ , $C_L = 100\text{ pF}$		1.3			
$t_s$ Settling time	$\epsilon = 0.1\%$	25°C	5		μs	
	$\epsilon = 0.01\%$		10			
$B_{OM}$ Maximum output-swing bandwidth	$A_{VD} = 1$ , $R_L = 10\text{ k}\Omega$	25°C	140		kHz	
$\phi_m$ Phase margin at unity gain (see Figure 3)	$R_L = 10\text{ k}\Omega$ , $C_L = 100\text{ pF}$	25°C	58°			
	$R_L = 100\ \Omega$ , $C_L = 100\text{ pF}$		75°			

† Full range is  $-40^\circ\text{C}$  to  $85^\circ\text{C}$ .

**TLE206x, TLE206xA, TLE206xB**  
**EXCALIBUR JFET-INPUT HIGH-OUTPUT-DRIVE**  
**μPOWER OPERATIONAL AMPLIFIERS**

SLOS193B – FEBRUARY 1997 – REVISED MAY 2004

**TLE2064I electrical characteristics at specified free-air temperature,  $V_{CC\pm} = \pm 15\text{ V}$  (unless otherwise noted)**

PARAMETER		TEST CONDITIONS	$T_A$ †	TLE2064I TLE2064AI TLE2064BI			UNIT	
				MIN	TYP	MAX		
$V_{IO}$	Input offset voltage	$V_{IC} = 0,$ $R_S = 50\ \Omega$	25°C	0.9	6	mV		
			Full range	7.3				
			25°C	0.9	4			
			Full range	5.3				
			25°C	0.7	2			
			Full range	3.3				
$\alpha_{VIO}$	Temperature coefficient of input offset voltage			25°C	6			$\mu\text{V}/^\circ\text{C}$
	Input offset voltage long-term drift (see Note 4)			Full range	0.04			$\mu\text{V}/\text{mo}$
$I_{IO}$	Input offset current		25°C	2		pA		
			Full range	3		nA		
$I_{IB}$	Input bias current		25°C	4		pA		
			Full range	5		nA		
$V_{ICR}$	Common-mode input voltage range		25°C	-11 to 13	-12 to 16	V		
			Full range	-11 to 13		V		
$V_{OM+}$	Maximum positive peak output voltage swing	$R_L = 10\ \text{k}\Omega$	25°C	13.2	13.7	V		
			Full range	13				
			25°C	12.5	13.2			
			Full range	12				
$V_{OM-}$	Maximum negative peak output voltage swing	$R_L = 10\ \text{k}\Omega$	25°C	-13.2	-13.7	V		
			Full range	-13				
			25°C	-12.5	-13			
			Full range	-12				
$A_{VD}$	Large-signal differential voltage amplification	$V_O = \pm 10\ \text{V},$ $R_L = 10\ \text{k}\Omega$	25°C	30	230	V/mV		
			Full range	20				
			25°C	25	100			
			Full range	10				
			25°C	3	25			
			Full range	1				
$r_i$	Input resistance		25°C	$10^{12}$		$\Omega$		
$c_i$	Input capacitance		25°C	4		pF		
$z_o$	Open-loop output impedance	$I_O = 0$	25°C	560		$\Omega$		
CMRR	Common-mode rejection ratio	$V_{IC} = V_{ICR\text{min}},$ $R_S = 50\ \Omega$	25°C	72	90	dB		
			Full range	65				
$k_{SVR}$	Supply-voltage rejection ratio ( $\Delta V_{CC\pm} / \Delta V_{IO}$ )	$V_{CC\pm} = \pm 5\ \text{V}$ to $\pm 15\ \text{V},$ $R_S = 50\ \Omega$	25°C	75	93	dB		
			Full range	65				

† Full range is -40°C to 85°C.

NOTE 4: Typical values are based on the input offset voltage shift observed through 168 hours of operating life test at  $T_A = 150^\circ\text{C}$  extrapolated to  $T_A = 25^\circ\text{C}$  using the Arrhenius equation and assuming an activation energy of 0.96 eV.



**TLE206x, TLE206xA, TLE206xB**  
**EXCALIBUR JFET-INPUT HIGH-OUTPUT-DRIVE**  
**μPOWER OPERATIONAL AMPLIFIERS**

SLOS193B – FEBRUARY 1997 – REVISED MAY 2004

**TLE2064I electrical characteristics at specified free-air temperature,  $V_{CC\pm} = \pm 15$  V (unless otherwise noted) (continued)**

PARAMETER	TEST CONDITIONS	$T_A$ †	TLE2064I TLE2064AI TLE2064BI			UNIT
			MIN	TYP	MAX	
$I_{CC}$ Supply current (four amplifiers)	$V_O = 0$ , No load	25°C	1.25	1.4	mA	
		Full range	1.5			
$\Delta I_{CC}$ Supply-current change over operating temperature range (four amplifiers)		Full range	148		μA	
$V_{O1}/V_{O2}$ Crosstalk attenuation	$A_{VD} = 1000$ , $f = 1$ kHz	25°C	120		dB	

† Full range is – 40°C to 85°C.

**TLE2064I operating characteristics at specified free-air temperature,  $V_{CC\pm} = \pm 15$  V**

PARAMETER	TEST CONDITIONS	$T_A$ †	TLE2064I TLE2064AI TLE2064BI			UNIT
			MIN	TYP	MAX	
SR Slew rate at unity gain (see Figure 1)	$R_L = 10$ kΩ, $C_L = 100$ pF	25°C	2.6	3.4	V/μs	
		Full range	2.1			
$V_n$ Equivalent input noise voltage (see Figure 2)	$f = 10$ Hz, $R_S = 20$ Ω, $f = 1$ kHz, $R_S = 20$ Ω	25°C	70	100	$nV/\sqrt{Hz}$	
			40	60		
$V_{N(PP)}$ Peak-to-peak equivalent input noise voltage	$f = 0.1$ Hz to 10 Hz	25°C	1.1		μV	
$I_n$ Equivalent input noise current	$f = 1$ kHz	25°C	1.1		fA/√Hz	
THD Total harmonic distortion	$A_{VD} = 2$ , $f = 10$ kHz, $R_L = 10$ kΩ $V_{O(PP)} = 2$ V,	25°C	0.025%			
$B_1$ Unity-gain bandwidth (see Figure 3)	$R_L = 10$ kΩ, $C_L = 100$ pF	25°C	2		MHz	
	$R_L = 600$ Ω, $C_L = 100$ pF		1.5			
$t_s$ Settling time	$\epsilon = 0.1\%$	25°C	5		μs	
	$\epsilon = 0.01\%$		10			
$B_{OM}$ Maximum output-swing bandwidth	$A_{VD} = 1$ , $R_L = 10$ kΩ	25°C	40		kHz	
$\phi_m$ Phase margin at unity gain (see Figure 3)	$R_L = 10$ kΩ, $C_L = 100$ pF	25°C	60°			
	$R_L = 600$ Ω, $C_L = 100$ pF		70°			

† Full range is – 40°C to 85°C.

**TLE206x, TLE206xA, TLE206xB**  
**EXCALIBUR JFET-INPUT HIGH-OUTPUT-DRIVE**  
**μPOWER OPERATIONAL AMPLIFIERS**

SLOS193B – FEBRUARY 1997 – REVISED MAY 2004

**TLE2064M electrical characteristics at specified free-air temperature,  $V_{CC\pm} = \pm 5\text{ V}$  (unless otherwise noted)**

PARAMETER		TEST CONDITIONS	$T_A$ †	TLE2064M TLE2064AM TLE2064BM			UNIT
				MIN	TYP	MAX	
$V_{IO}$	Input offset voltage	$V_{IC} = 0, R_S = 50\ \Omega$	25°C	1.2	7	mV	
			Full range		9		
			25°C	1.2	6		
			Full range		8		
			25°C	0.8	3.5		
			Full range		5.5		
$\alpha_{VIO}$	Temperature coefficient of input offset voltage	$V_{IC} = 0, R_S = 50\ \Omega$	25°C	6		$\mu\text{V}/^\circ\text{C}$	
	Input offset voltage long-term drift (see Note 4)		Full range	0.04		$\mu\text{V}/\text{mo}$	
$I_{IO}$	Input offset current	$V_{IC} = 0, R_S = 50\ \Omega$	25°C	1		pA	
			Full range		15	nA	
$I_{IB}$	Input bias current	$V_{IC} = 0, R_S = 50\ \Omega$	25°C	3		pA	
			Full range		30	nA	
$V_{ICR}$	Common-mode input voltage range		25°C	-1.6 to 4	-2 to 6	V	
			Full range	-1.6 to 4		V	
$V_{OM+}$	Maximum positive peak output voltage swing	$R_L = 10\ \text{k}\Omega$	25°C	3.5	3.7	V	
			Full range		3		
		FK and J packages	$R_L = 600\ \Omega$	25°C	2.5		3.6
				Full range			2
		D and N packages	$R_L = 100\ \Omega$	25°C	2.5		3.1
				Full range			2
$V_{OM-}$	Maximum negative peak output voltage swing	$R_L = 10\ \text{k}\Omega$	25°C	-3.5	-3.9	V	
			Full range		-3		
		FK and J packages	$R_L = 600\ \Omega$	25°C	-2.5		-3.5
				Full range			-2
		D and N packages	$R_L = 100\ \Omega$	25°C	-2.5		-2.7
				Full range			-2
$A_{VD}$	Large-signal differential voltage amplification	$V_O = \pm 2.8\ \text{V}, R_L = 10\ \text{k}\Omega$	25°C	15	80	V/mV	
			Full range		2		
		FK and J packages	$V_O = 0\ \text{to}\ 2.5\ \text{V}, R_L = 600\ \Omega$	25°C	1		65
				Full range			0.5
			$V_O = 0\ \text{to}\ -2.5\ \text{V}, R_L = 600\ \Omega$	25°C	1		16
				Full range			0.5

† Full range is -55°C to 125°C.

NOTE 4: Typical values are based on the input offset voltage shift observed through 168 hours of operating life test at  $T_A = 150^\circ\text{C}$  extrapolated to  $T_A = 25^\circ\text{C}$  using the Arrhenius equation and assuming an activation energy of 0.96 eV.





**TLE206x, TLE206xA, TLE206xB**  
**EXCALIBUR JFET-INPUT HIGH-OUTPUT-DRIVE**  
**μPOWER OPERATIONAL AMPLIFIERS**

SLOS193B – FEBRUARY 1997 – REVISED MAY 2004

**TLE2064M electrical characteristics at specified free-air temperature,  $V_{CC\pm} = \pm 5\text{ V}$  (unless otherwise noted) continued)**

PARAMETER		TEST CONDITIONS	$T_A^\dagger$	TLE2064M TLE2064AM TLE2064BM			UNIT
				MIN	TYP	MAX	
$A_{VD}$	Large-signal differential voltage amplification	D and N packages	$V_O = 0$ to $2\text{ V}$ , $R_L = 100\ \Omega$	25°C	0.75	45	V/mV
				Full range	0.25		
		$V_O = 0$ to $-2\text{ V}$ , $R_L = 100\ \Omega$	25°C	0.4	3		
			Full range	0.15			
$r_i$	Input resistance		25°C	10 <sup>12</sup>		$\Omega$	
$c_i$	Input capacitance		25°C	4		pF	
$z_o$	Open-loop output impedance	$I_O = 0$	25°C	560		$\Omega$	
CMRR	Common-mode rejection ratio	$V_{IC} = V_{ICRmin}$ , $R_S = 50\ \Omega$	25°C	65	82	dB	
			Full range	60			
$k_{SVR}$	Supply-voltage rejection ratio ( $\Delta V_{CC\pm} / \Delta V_{IO}$ )	$V_{CC\pm} = \pm 5\text{ V}$ to $\pm 15\text{ V}$ , $R_S = 50\ \Omega$	25°C	75	93	dB	
			Full range	65			
$I_{CC}$	Supply current (four amplifiers)	$V_O = 0$ , No load	25°C	1.12	1.3	mA	
			Full range	1.3			
$\Delta I_{CC}$	Supply-current change over operating temperature range (four amplifiers)		Full range	144		$\mu\text{A}$	
$V_{O1}/V_{O2}$	Crosstalk attenuation	$A_{VD} = 1000$ , $f = 1\text{ kHz}$	25°C	120		dB	

$^\dagger$  Full range is  $-55^\circ\text{C}$  to  $125^\circ\text{C}$ .

**TLE2064M operating characteristics,  $V_{CC\pm} = \pm 5\text{ V}$ ,  $T_A = 25^\circ\text{C}$**

PARAMETER		TEST CONDITIONS	TLE2064M TLE2064AM TLE2064BM			UNIT
			MIN	TYP	MAX	
SR	Slew rate at unity gain (see Figure 1)	$R_L = 10\text{ k}\Omega$ , $C_L = 100\text{ pF}$	3.4			V/ $\mu\text{s}$
$V_n$	Equivalent input noise voltage (see Figure 2)	$f = 10\text{ Hz}$ , $R_S = 20\ \Omega$	59			nV/ $\sqrt{\text{Hz}}$
		$f = 1\text{ kHz}$ , $R_S = 20\ \Omega$	43			
$V_{N(PP)}$	Peak-to-peak equivalent input noise voltage	$f = 0.1\text{ Hz}$ to $10\text{ Hz}$	1.1			$\mu\text{V}$
$I_n$	Equivalent input noise current	$f = 1\text{ kHz}$	1			fA/ $\sqrt{\text{Hz}}$
THD	Total harmonic distortion	$A_{VD} = 2$ , $f = 10\text{ kHz}$ , $V_{O(PP)} = 2\text{ V}$ , $R_L = 10\text{ k}\Omega$	0.025%			
$B_1$	Unity-gain bandwidth (see Figure 3)	$R_L = 10\text{ k}\Omega$ , $C_L = 100\text{ pF}$	1.8			MHz
		$R_L = 600\ \Omega$ , $C_L = 100\text{ pF}$	1.3			
$t_s$	Settling time	$\epsilon = 0.1\%$	5			$\mu\text{s}$
		$\epsilon = 0.01\%$	10			
$B_{OM}$	Maximum output-swing bandwidth	$A_{VD} = 1$ , $R_L = 10\text{ k}\Omega$	140			kHz
$\phi_m$	Phase margin at unity gain (see Figure 3)	$R_L = 10\text{ k}\Omega$ , $C_L = 100\text{ pF}$	58°			
		$R_L = 600\ \Omega$ , $C_L = 100\text{ pF}$	75°			



**TLE206x, TLE206xA, TLE206xB**  
**EXCALIBUR JFET-INPUT HIGH-OUTPUT-DRIVE**  
**μPOWER OPERATIONAL AMPLIFIERS**

SLOS193B – FEBRUARY 1997 – REVISED MAY 2004

**TLE2064M electrical characteristics at specified free-air temperature,  $V_{CC\pm} = \pm 15\text{ V}$  (unless otherwise noted)**

PARAMETER		TEST CONDITIONS	$T_A$ †	TLE2064M TLE2064AM TLE2064BM			UNIT
				MIN	TYP	MAX	
$V_{IO}$	Input offset voltage	$V_{IC} = 0, R_S = 50\ \Omega$	25°C	0.9	6	mV	
			Full range		8		
			25°C	0.9	4		
			Full range		6		
			25°C	0.7	2		
			Full range		4		
$\alpha_{VIO}$	Temperature coefficient of input offset voltage	$V_{IC} = 0, R_S = 50\ \Omega$	25°C	6		$\mu\text{V}/^\circ\text{C}$	
	Input offset voltage long-term drift (see Note 4)		Full range	0.04		$\mu\text{V}/\text{mo}$	
$I_{IO}$	Input offset current		25°C	2		pA	
			Full range		20	nA	
$I_{IB}$	Input bias current		25°C	4		pA	
			Full range		40	nA	
$V_{ICR}$	Common-mode input voltage range		25°C	-11 to 13	-12 to 16	V	
			Full range	-11 to 13		V	
$V_{OM+}$	Maximum positive peak output voltage swing	$R_L = 10\ \text{k}\Omega$	25°C	13	13.7	V	
			Full range	12.5			
		$R_L = 600\ \Omega$	25°C	12.5	13.2		
			Full range	12			
$V_{OM-}$	Maximum negative peak output voltage swing	$R_L = 10\ \text{k}\Omega$	25°C	-13	-13.7	V	
			Full range	-12.5			
		$R_L = 600\ \Omega$	25°C	-13	-13		
			Full range	-12.5			
$A_{VD}$	Large-signal differential voltage amplification	$V_O = \pm 10\ \text{V}, R_L = 10\ \text{k}\Omega$	25°C	30	230	V/mV	
			Full range	20			
		$V_O = 0\ \text{to}\ 8\ \text{V}, R_L = 600\ \Omega$	25°C	25	100		
			Full range	7			
		$V_O = 0\ \text{to}\ -8\ \text{V}, R_L = 600\ \Omega$	25°C	3	25		
			Full range	1			
$r_i$	Input resistance		25°C	$10^{12}$	$\Omega$		
$c_i$	Input capacitance		25°C	4	pF		
$z_o$	Open-loop output impedance	$I_O = 0$	25°C	560	$\Omega$		
CMRR	Common-mode rejection ratio	$V_{IC} = V_{ICRmin}, R_S = 50\ \Omega$	25°C	72	90	dB	
			Full range	65			
$k_{SVR}$	Supply-voltage rejection ratio ( $\Delta V_{CC\pm} / \Delta V_{IO}$ )	$V_{CC\pm} = \pm 5\ \text{V to } \pm 15\ \text{V}, R_S = 50\ \Omega$	25°C	75	93	dB	
			Full range	65			

† Full range is -55°C to 125°C.

NOTE 4: Typical values are based on the input offset voltage shift observed through 168 hours of operating life test at  $T_A = 150^\circ\text{C}$  extrapolated to  $T_A = 25^\circ\text{C}$  using the Arrhenius equation and assuming an activation energy of 0.96 eV.



**TLE206x, TLE206xA, TLE206xB**  
**EXCALIBUR JFET-INPUT HIGH-OUTPUT-DRIVE**  
**μPOWER OPERATIONAL AMPLIFIERS**

SLOS193B – FEBRUARY 1997 – REVISED MAY 2004

**TLE2064M electrical characteristics at specified free-air temperature,  $V_{CC\pm} = \pm 15$  V (unless otherwise noted) (continued)**

PARAMETER	TEST CONDITIONS	$T_A$ †	TLE2064M TLE2064AM TLE2064BM			UNIT
			MIN	TYP	MAX	
$I_{CC}$ Supply current (four amplifiers)	$V_O = 0$ , No load	25°C	1.25	1.4	mA	
		Full range	1.5			
$\Delta I_{CC}$ Supply-current change over operating temperature range (four amplifiers)		Full range	194	$\mu A$		
$V_{O1}/V_{O2}$ Crosstalk attenuation	$A_{VD} = 1000$ , $f = 1$ kHz	25°C	120	dB		

† Full range is – 55°C to 125°C.

**TLE2064M operating characteristics at specified free-air temperature,  $V_{CC\pm} = \pm 15$  V**

PARAMETER	TEST CONDITIONS	$T_A$ †	TLE2064M TLE2064AM TLE2064BM			UNIT
			MIN	TYP	MAX	
SR Slew rate at unity gain (see Figure 1)	$R_L = 10$ k $\Omega$ , $C_L = 100$ pF	25°C	2.6	3.4	$V/\mu s$	
		Full range	1.8			
$V_n$ Equivalent input noise voltage (see Figure 2)	$f = 10$ Hz, $R_S = 20$ $\Omega$	25°C	70		$nV/\sqrt{Hz}$	
	$f = 1$ kHz, $R_S = 20$ $\Omega$		40			
$V_{N(PP)}$ Peak-to-peak equivalent input noise voltage	$f = 0.1$ Hz to 10 Hz	25°C	1.1		$\mu V$	
$I_n$ Equivalent input noise current	$f = 1$ kHz	25°C	1.1		$fA/\sqrt{Hz}$	
THD Total harmonic distortion	$A_{VD} = 2$ , $f = 10$ kHz, $V_{O(PP)} = 2$ V, $R_L = 10$ k $\Omega$	25°C	0.025%			
$B_1$ Unity-gain bandwidth (see Figure 3)	$R_L = 10$ k $\Omega$ , $C_L = 100$ pF	25°C	2		MHz	
	$R_L = 600$ $\Omega$ , $C_L = 100$ pF		1.5			
$t_s$ Settling time	$\epsilon = 0.1\%$	25°C	5		$\mu s$	
	$\epsilon = 0.01\%$		10			
$B_{OM}$ Maximum output-swing bandwidth	$A_{VD} = 1$ , $R_L = 10$ k $\Omega$	25°C	40		kHz	
$\phi_m$ Phase margin at unity gain (see Figure 3)	$R_L = 10$ k $\Omega$ , $C_L = 100$ pF	25°C	60°			
	$R_L = 600$ $\Omega$ , $C_L = 100$ pF		70°			

† Full range is – 55°C to 125°C.

# TLE206x, TLE206xA, TLE206xB EXCALIBUR JFET-INPUT HIGH-OUTPUT-DRIVE μPOWER OPERATIONAL AMPLIFIERS

SLOS193B – FEBRUARY 1997 – REVISED MAY 2004

## TLE2064Y electrical characteristics at $V_{CC\pm} = \pm 15\text{ V}$ , $T_A = 25^\circ\text{C}$ (unless otherwise noted)

PARAMETER	TEST CONDITIONS	TLE2064Y			UNIT
		MIN	TYP	MAX	
$V_{IO}$ Input offset voltage	$V_{IC} = 0$ , $R_S = 50\ \Omega$		0.9	6	mV
$\infty V_{IO}$ Input offset voltage long-term drift (see Note 4)			0.04		$\mu\text{V}/\text{mo}$
$I_{IO}$ Input offset current			2		pA
$I_{IB}$ Input bias current			4		pA
$V_{ICR}$ Common-mode input voltage range		-11 to 13	-12 to 16		V
$V_{OM+}$ Maximum positive peak output voltage swing	$R_L = 10\ \text{k}\Omega$	13.2	13.7		V
	$R_L = 600\ \Omega$	12.5	13.2		
$V_{OM-}$ Maximum negative peak output voltage swing	$R_L = 10\ \text{k}\Omega$	-13.2	-13.7		V
	$R_L = 600\ \Omega$	12.5	13		V
$A_{VD}$ Large-signal differential voltage amplification	$V_O = \pm 10\ \text{V}$ , $R_L = 10\ \text{k}\Omega$	30	230		V/mV
	$V_O = 0\ \text{to}\ 8\ \text{V}$ , $R_L = 600\ \Omega$	25	100		
	$V_O = 0\ \text{to}\ -8\ \text{V}$ , $R_L = 600\ \Omega$	3	25		
$r_i$ Input resistance			$10^{12}$		$\Omega$
$c_i$ Input capacitance			4		pF
$z_o$ Open-loop output impedance	$I_O = 0$		560		$\Omega$
CMRR Common-mode rejection ratio	$R_S = 50\ \Omega$ , $V_{IC} = V_{ICR\text{min}}$	72	90		dB
$k_{SVR}$ Supply-voltage rejection ratio ( $\Delta V_{CC\pm} / \Delta V_{IO}$ )	$V_{CC\pm} = \pm 5\ \text{V}\ \text{to}\ \pm 15\ \text{V}$ , $R_S = 50\ \Omega$	75	93		dB
$I_{CC}$ Supply current	$V_O = 0$ , No load		1.25	1.4	mA
$V_{O1}/V_{O2}$ Crosstalk attenuation	$A_{VD} = 1000$ , $f = 1\ \text{kHz}$		120		dB

NOTE 4: Typical values are based on the input offset voltage shift observed through 168 hours of operating life test at  $T_A = 150^\circ\text{C}$  extrapolated to  $T_A = 25^\circ\text{C}$  using the Arrhenius equation and assuming an activation energy of 0.96 eV.

## TLE2064Y operating characteristics at $V_{CC\pm} = \pm 15\ \text{V}$ , $T_A = 25^\circ\text{C}$

PARAMETER	TEST CONDITIONS	TLE2064Y			UNIT
		MIN	TYP	MAX	
SR Slew rate at unity gain (see Figure 1)	$R_L = 10\ \text{k}\Omega$ , $C_L = 100\ \text{pF}$	2.6	3.4		V/ $\mu\text{s}$
$V_n$ Equivalent input noise voltage (see Figure 2)	$f = 10\ \text{Hz}$ , $R_S = 20\ \Omega$		70		nV/ $\sqrt{\text{Hz}}$
	$f = 1\ \text{kHz}$ , $R_S = 20\ \Omega$		40		
$V_{N(PP)}$ Peak-to-peak equivalent input noise voltage	$f = 0.1\ \text{Hz}\ \text{to}\ 10\ \text{Hz}$		1.1		$\mu\text{V}$
$I_n$ Equivalent input noise current	$f = 1\ \text{kHz}$		1.1		fA/ $\sqrt{\text{Hz}}$
THD Total harmonic distortion	$A_{VD} = 2$ , $f = 10\ \text{kHz}$ , $V_{O(PP)} = 2\ \text{V}$ , $R_L = 10\ \text{k}\Omega$		0.025%		
$B_1$ Unity-gain bandwidth (see Figure 3)	$R_L = 10\ \text{k}\Omega$ , $C_L = 100\ \text{pF}$		2		MHz
	$R_L = 600\ \Omega$ , $C_L = 100\ \text{pF}$		1.5		
$t_s$ Settling time	$\epsilon = 0.1\%$		5		$\mu\text{s}$
	$\epsilon = 0.01\%$		10		
BOM Maximum output-swing bandwidth	$A_{VD} = 1$ , $R_L = 10\ \text{k}\Omega$		40		kHz
$\phi_m$ Phase margin at unity gain (see Figure 3)	$R_L = 10\ \text{k}\Omega$ , $C_L = 100\ \text{pF}$		60°		
	$R_L = 600\ \Omega$ , $C_L = 100\ \text{pF}$		70°		



**PARAMETER MEASUREMENT INFORMATION**

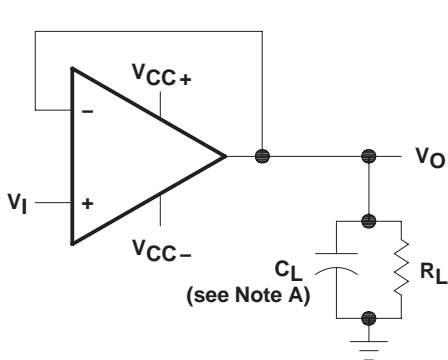

NOTE A:  $C_L$  includes fixture capacitance.

**Figure 1. Slew-Rate Test Circuit**

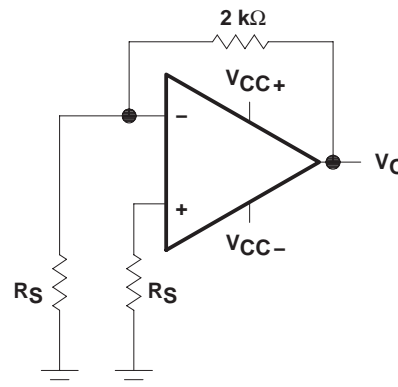

**Figure 2. Noise-Voltage Test Circuit**



NOTE A:  $C_L$  includes fixture capacitance.

**Figure 3. Unity-Gain Bandwidth and Phase-Margin Test Circuit**

**typical values**

Typical values presented in this data sheet represent the median (50% point) of device parametric performance.

**input bias and offset current**

At the picoampere bias current level typical of the TLE206x, TLE2064xA, and TLE206xB, accurate measurement of the bias current becomes difficult. Not only does this measurement require a picoammeter, but test socket leakages can easily exceed the actual device bias currents. To accurately measure these small currents, Texas Instruments uses a two-step process. The socket leakage is measured using picoammeters with bias voltages applied but with no device in the socket. The device is then inserted into the socket and a second test that measures both the socket leakage and the device input bias current is performed. The two measurements are then subtracted algebraically to determine the bias current of the device.

**TLE206x, TLE206xA, TLE206xB**  
**EXCALIBUR JFET-INPUT HIGH-OUTPUT-DRIVE**  
**μPOWER OPERATIONAL AMPLIFIERS**

SLOS193B – FEBRUARY 1997 – REVISED MAY 2004

**TYPICAL CHARACTERISTICS**

**Table of Graphs**

		<b>FIGURE</b>	
$V_{IO}$	Input offset voltage	Distribution	4, 5, 6
$I_{IB}$	Input bias current	vs Common-mode input voltage	7
		vs Free-air temperature	8
$I_{IO}$	Input offset current	vs Free-air temperature	8
$V_{ICR}$	Common-mode input voltage	vs Free-air temperature	9
$V_{OM}$	Maximum peak output voltage	vs Output current	10, 11
		vs Supply voltage	12, 13, 14
$V_{O(PP)}$	Maximum peak-to-peak output voltage	vs Frequency	15, 16
		vs Load resistance	17
$A_{VD}$	Large-signal differential voltage amplification	vs Frequency	18
		vs Free-air temperature	19
$I_{OS}$	Short-circuit output current	vs Elapsed time	20
		vs Free-air temperature	21
$Z_o$	Output impedance	vs Frequency	22, 23
$CMRR$	Common-mode rejection ratio	vs Frequency	24
$I_{CC}$	Supply current	vs Supply voltage	25, 26, 27
		vs Free-air temperature	28, 29, 30
	Voltage-follower small-signal pulse response	vs Time	31, 32
	Voltage-follower large-signal pulse response	vs Time	33, 34
	Noise voltage (referred to input)	0.1 to 10 Hz	35
$V_n$	Equivalent input noise voltage	vs Frequency	36
$THD$	Total harmonic distortion	vs Frequency	37, 38
$B_1$	Unity-gain bandwidth	vs Supply voltage	39
		vs Free-air temperature	40
$\phi_m$	Phase margin	vs Supply voltage	41
		vs Load capacitance	42
		vs Free-air temperature	43
	Phase shift	vs Frequency	18

TYPICAL CHARACTERISTICS

TLE2061  
 DISTRIBUTION OF  
 INPUT OFFSET VOLTAGE

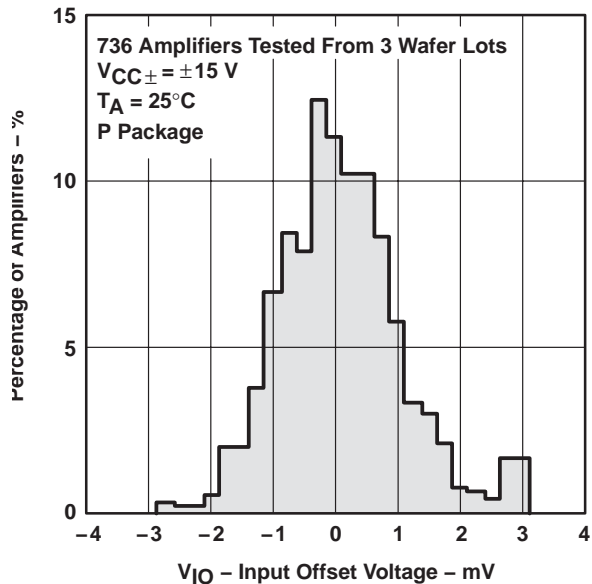

Figure 4

TLE2062  
 DISTRIBUTION OF  
 INPUT OFFSET VOLTAGE



Figure 5

TLE2064  
 DISTRIBUTION OF  
 INPUT OFFSET VOLTAGE

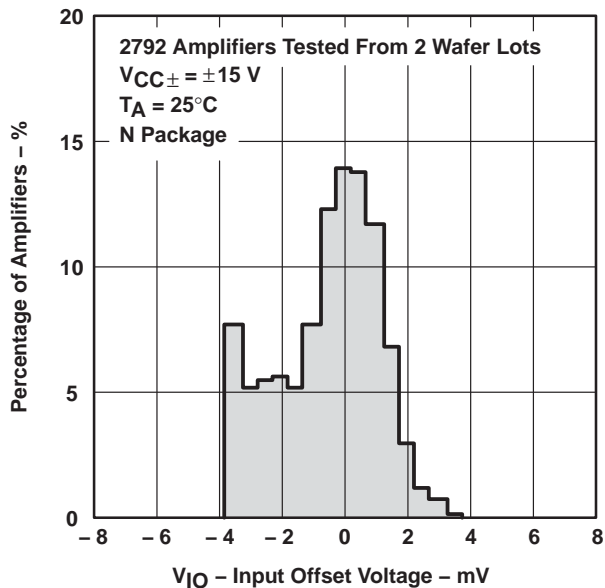

Figure 6

INPUT BIAS CURRENT  
 vs  
 COMMON-MODE INPUT VOLTAGE

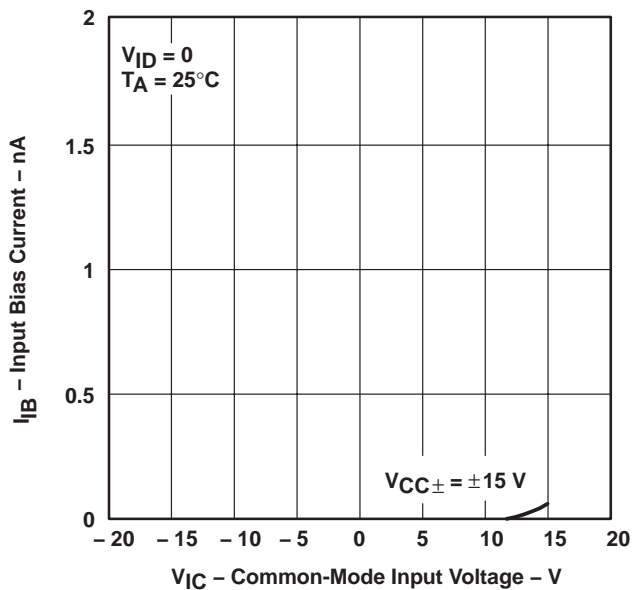

Figure 7

**TLE206x, TLE206xA, TLE206xB**  
**EXCALIBUR JFET-INPUT HIGH-OUTPUT-DRIVE**  
**μPOWER OPERATIONAL AMPLIFIERS**

SLOS193B – FEBRUARY 1997 – REVISED MAY 2004

**TYPICAL CHARACTERISTICS†**

**INPUT BIAS CURRENT  
 AND INPUT OFFSET CURRENT  
 vs  
 FREE-AIR TEMPERATURE**

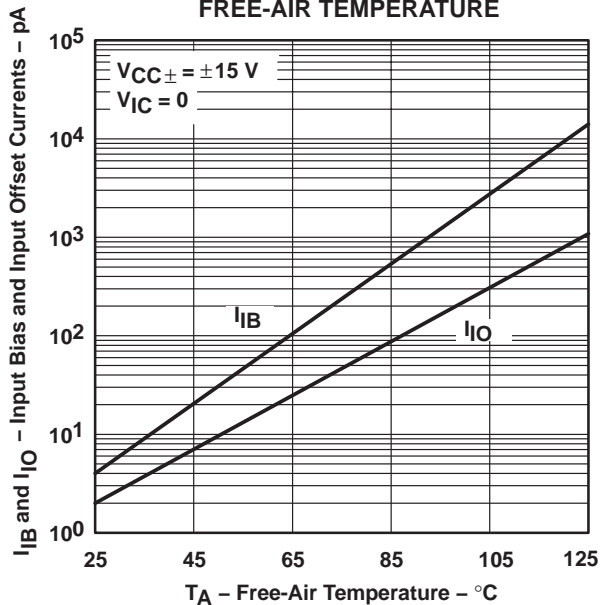

**Figure 8**

**COMMON-MODE INPUT VOLTAGE  
 vs  
 FREE-AIR TEMPERATURE**

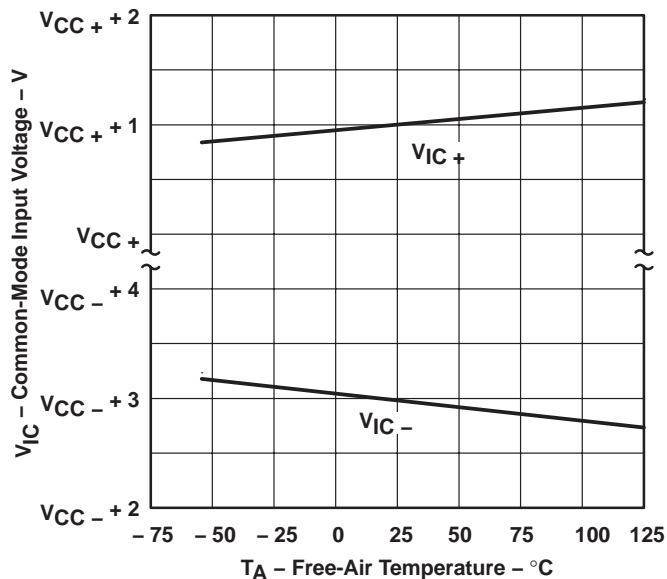

**Figure 9**

**MAXIMUM POSITIVE PEAK  
 OUTPUT VOLTAGE  
 vs  
 OUTPUT CURRENT**

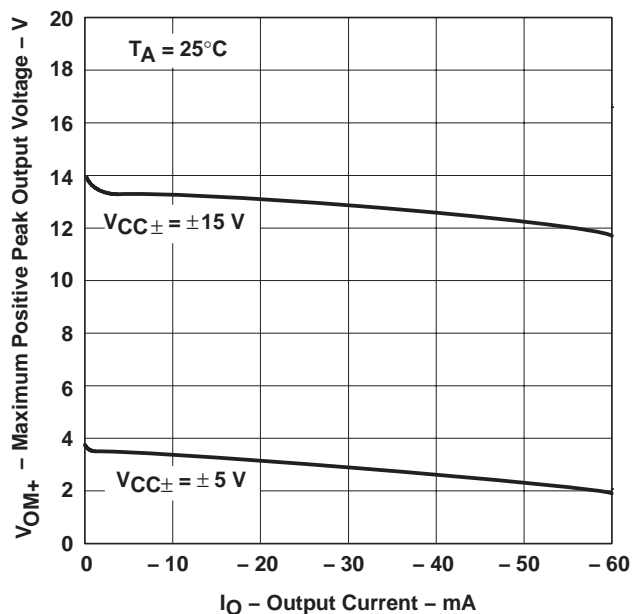

**Figure 10**

**MAXIMUM NEGATIVE PEAK  
 OUTPUT VOLTAGE  
 vs  
 OUTPUT CURRENT**

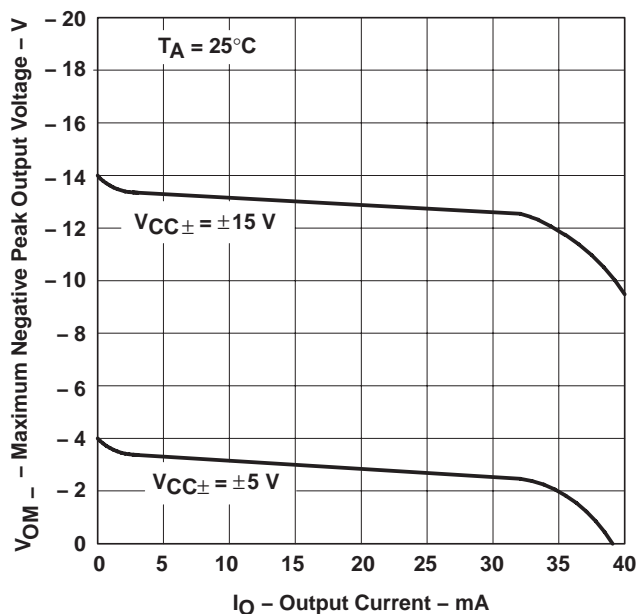

**Figure 11**

† Data at high and low temperatures are applicable only within the rated operating free-air temperature ranges of the various devices.





TYPICAL CHARACTERISTICS



Figure 12



Figure 13



Figure 14



Figure 15

**TYPICAL CHARACTERISTICS†**

**MAXIMUM PEAK-TO-PEAK  
 OUTPUT VOLTAGE  
 vs  
 FREQUENCY**

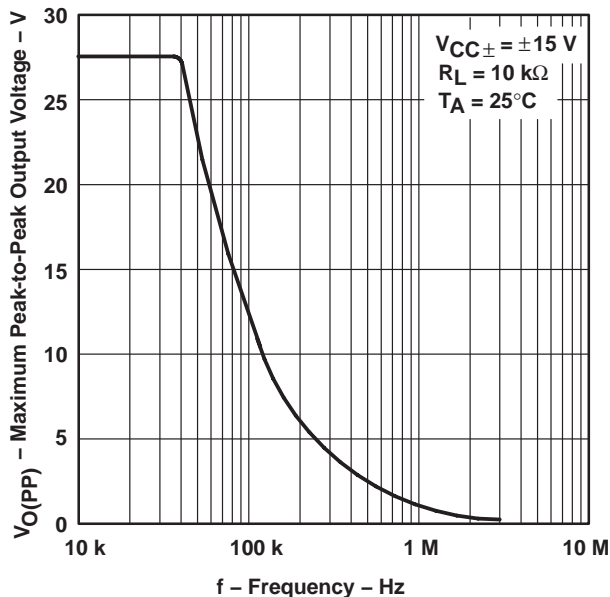

**Figure 16**

**MAXIMUM PEAK-TO-PEAK  
 OUTPUT VOLTAGE  
 vs  
 LOAD RESISTANCE**

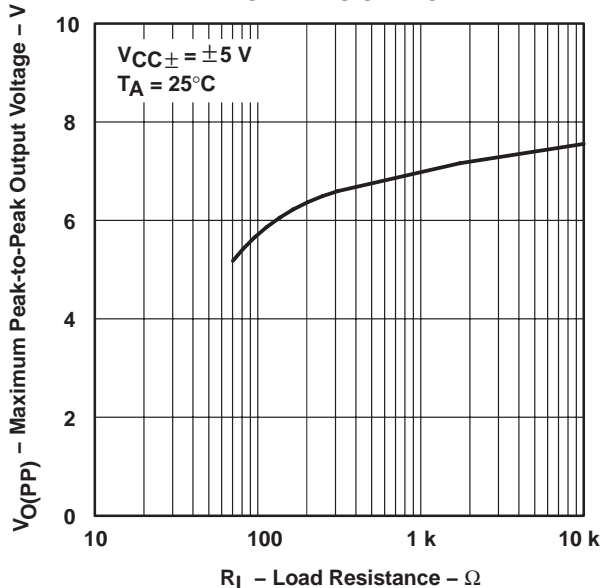

**Figure 17**

**LARGE-SIGNAL DIFFERENTIAL VOLTAGE  
 AMPLIFICATION AND PHASE SHIFT  
 vs  
 FREQUENCY**

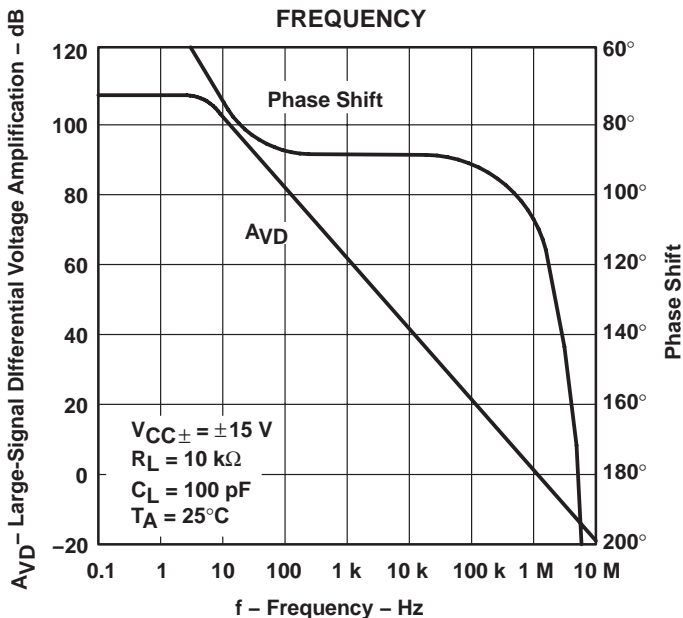

**Figure 18**

**LARGE-SIGNAL VOLTAGE AMPLIFICATION  
 vs  
 FREE-AIR TEMPERATURE**

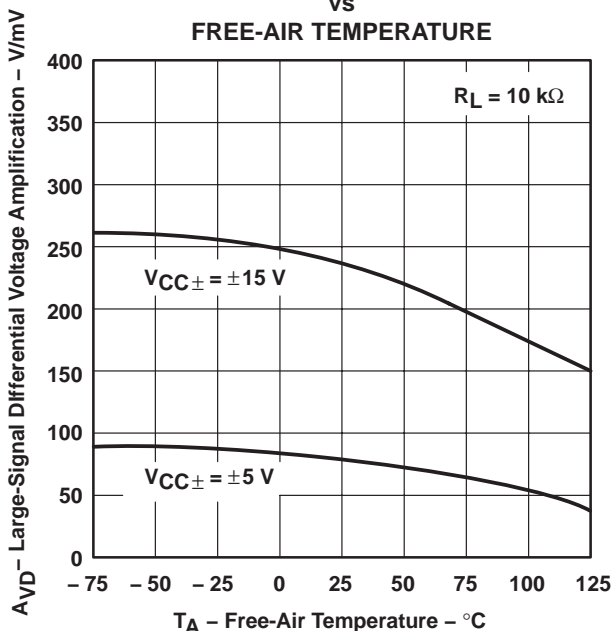

**Figure 19**

† Data at high and low temperatures are applicable only within the rated operating free-air temperature ranges of the various devices.

TYPICAL CHARACTERISTICS†



Figure 20



Figure 21

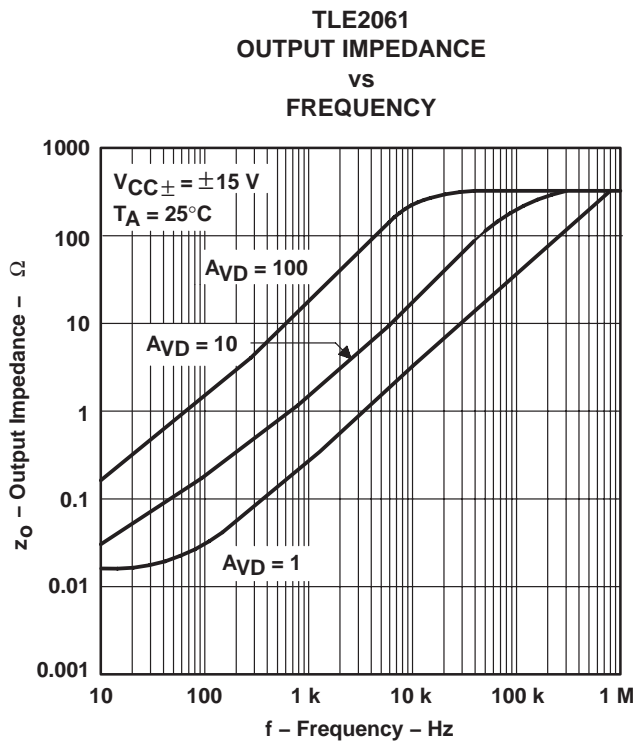

Figure 22

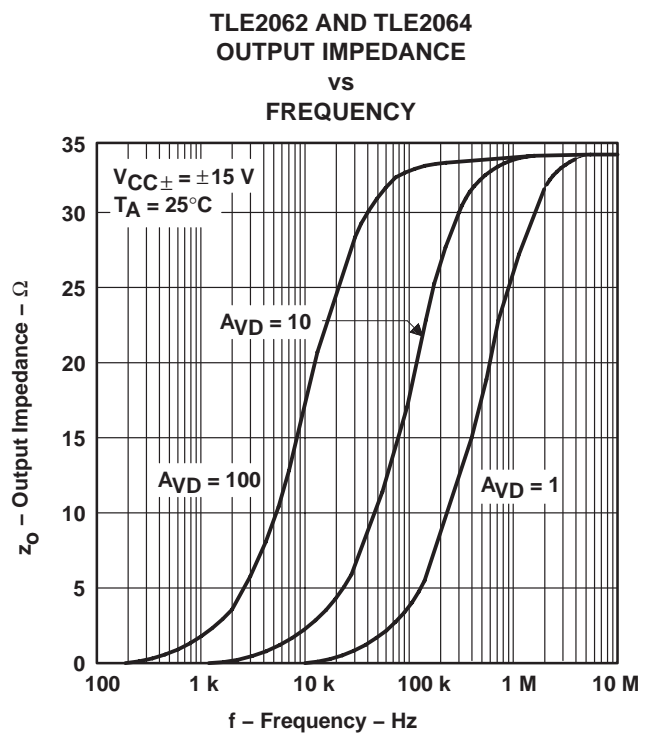

Figure 23

† Data at high and low temperatures are applicable only within the rated operating free-air temperature ranges of the various devices.

**TLE206x, TLE206xA, TLE206xB**  
**EXCALIBUR JFET-INPUT HIGH-OUTPUT-DRIVE**  
**μPOWER OPERATIONAL AMPLIFIERS**

SLOS193B – FEBRUARY 1997 – REVISED MAY 2004

**TYPICAL CHARACTERISTICS†**

**COMMON-MODE REJECTION RATIO**  
**vs**  
**FREQUENCY**

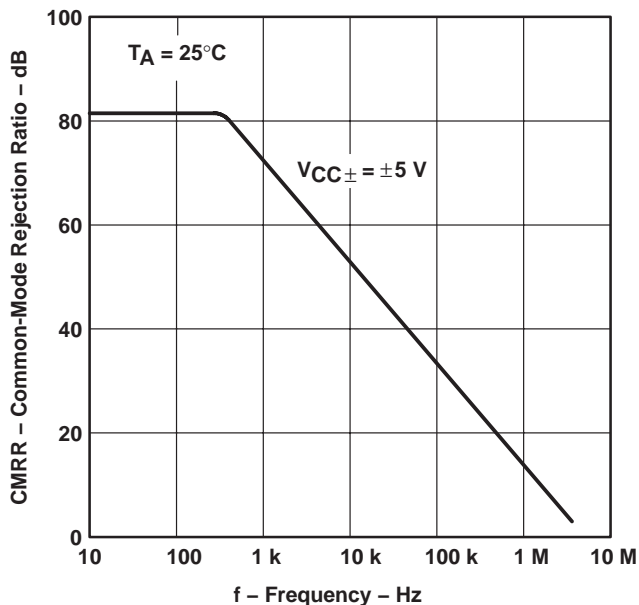

**Figure 24**

**TLE2061**  
**SUPPLY CURRENT**  
**vs**  
**SUPPLY VOLTAGE**

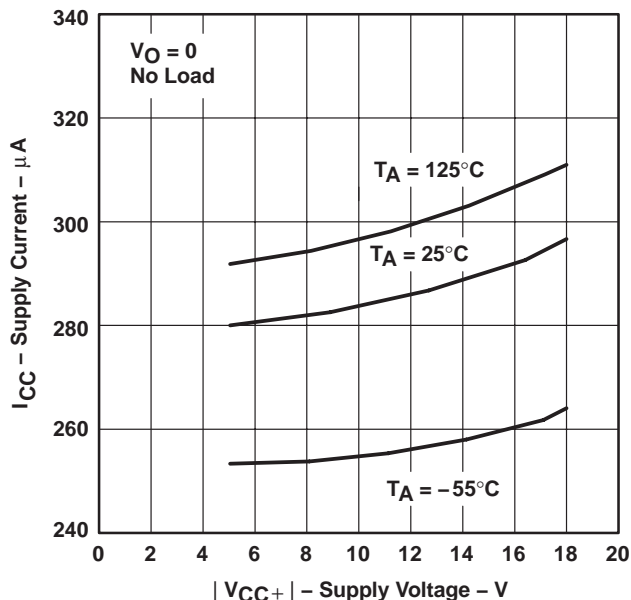

**Figure 25**

**TLE2062**  
**SUPPLY CURRENT**  
**vs**  
**SUPPLY VOLTAGE**

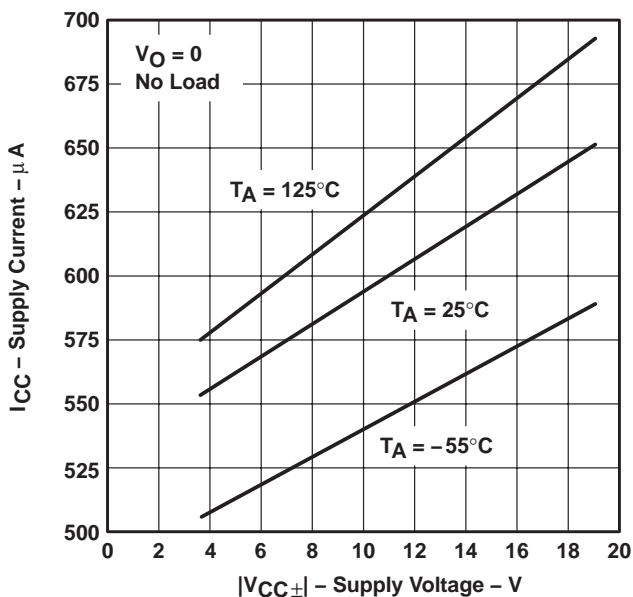

**Figure 26**

**TLE2064**  
**SUPPLY CURRENT**  
**vs**  
**SUPPLY VOLTAGE**

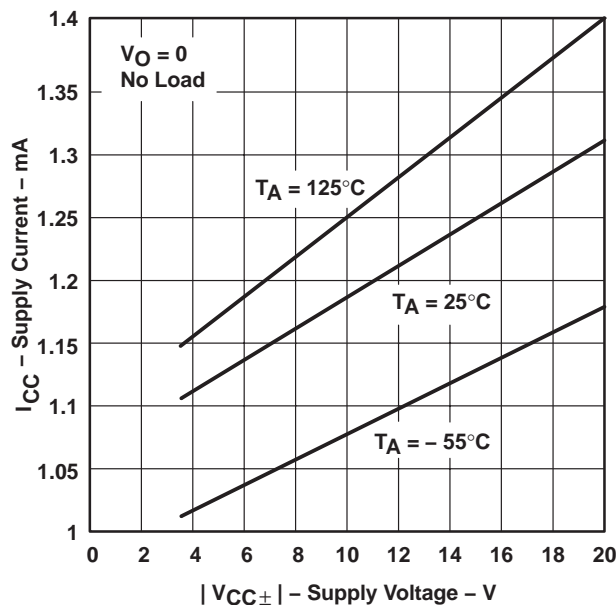
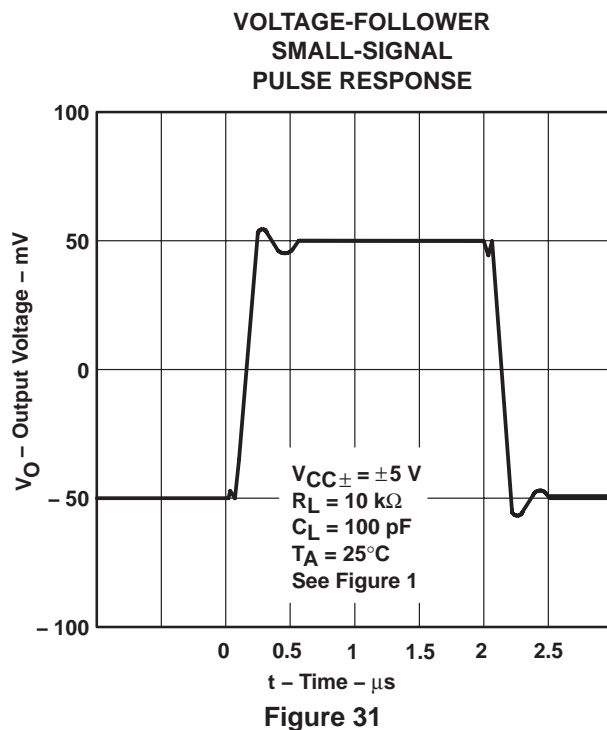
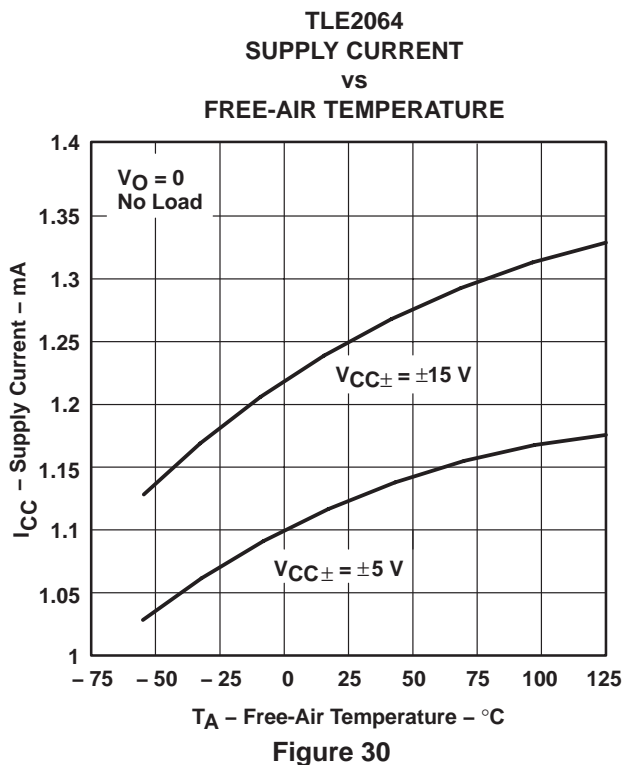
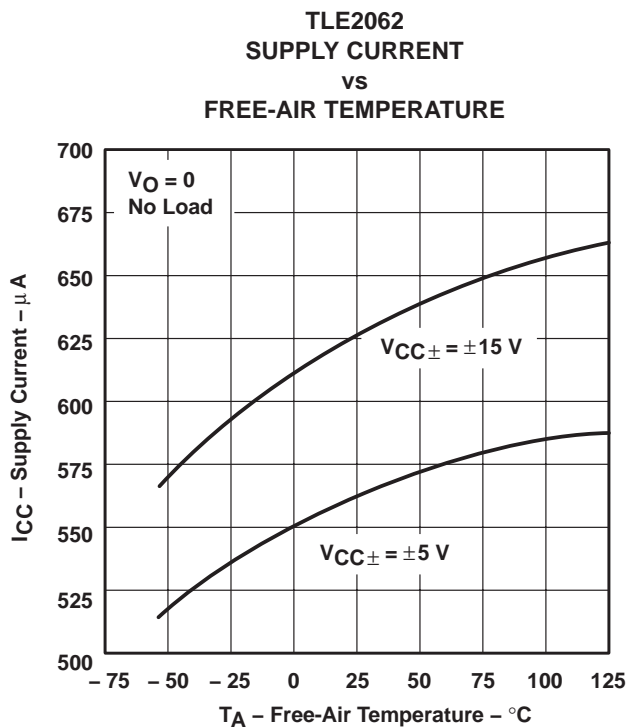
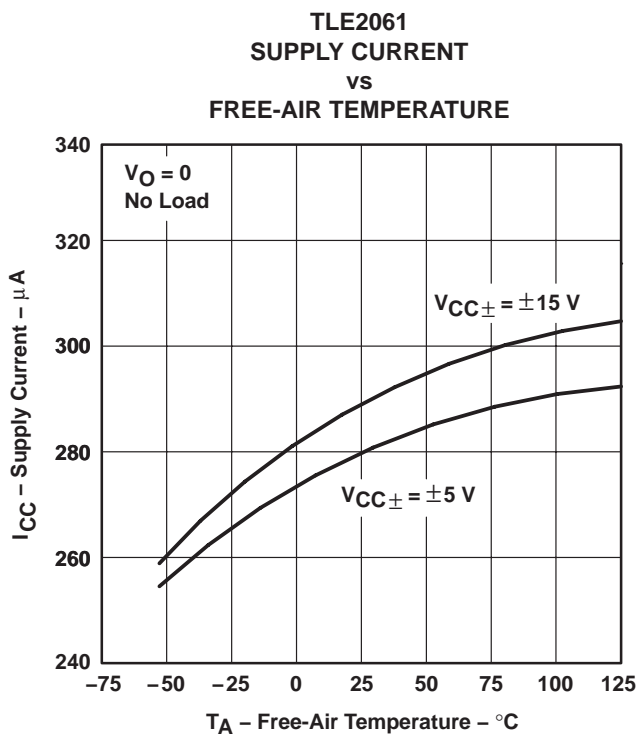

**Figure 27**

† Data at high and low temperatures are applicable only within the rated operating free-air temperature ranges of the various devices.



TYPICAL CHARACTERISTICS†



† Data at high and low temperatures are applicable only within the rated operating free-air temperature ranges of the various devices.

**TYPICAL CHARACTERISTICS**

**VOLTAGE-FOLLOWER  
 SMALL-SIGNAL  
 PULSE RESPONSE**



**Figure 32**

**VOLTAGE-FOLLOWER  
 LARGE-SIGNAL  
 PULSE RESPONSE**



**Figure 33**

**VOLTAGE-FOLLOWER  
 LARGE-SIGNAL  
 PULSE RESPONSE**



**Figure 34**

**NOISE VOLTAGE  
 (REFERRED TO INPUT)  
 0.1 TO 10 Hz**

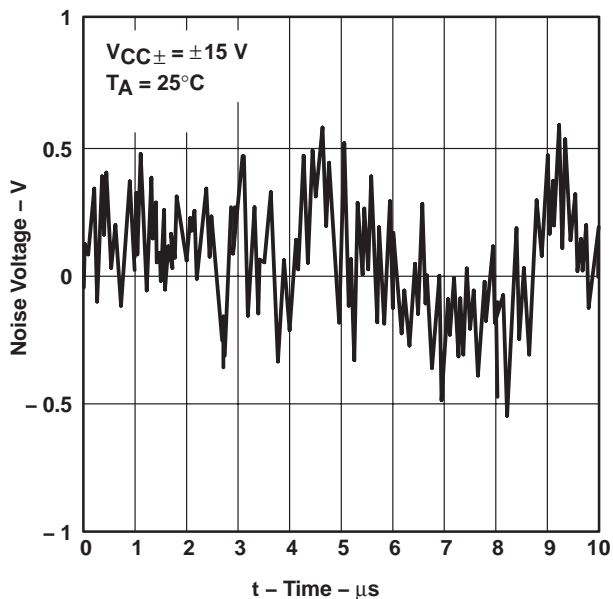

**Figure 35**

TYPICAL CHARACTERISTICS

EQUIVALENT INPUT NOISE VOLTAGE  
 vs  
 FREQUENCY

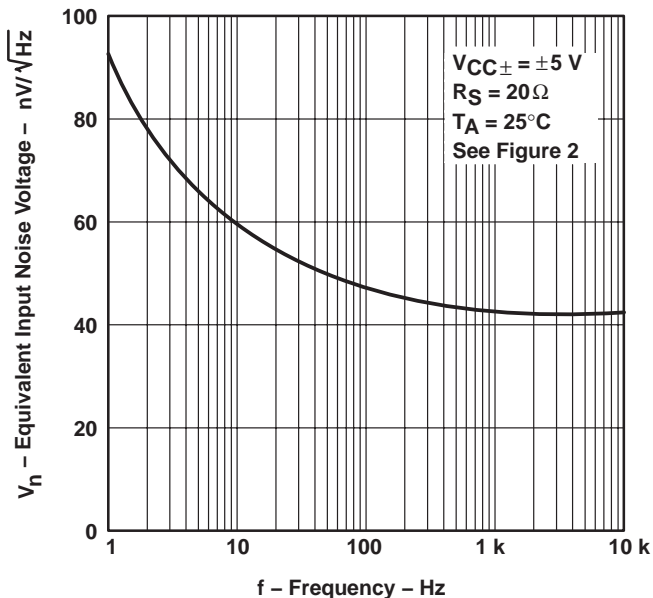

Figure 36

TOTAL HARMONIC DISTORTION  
 vs  
 FREQUENCY

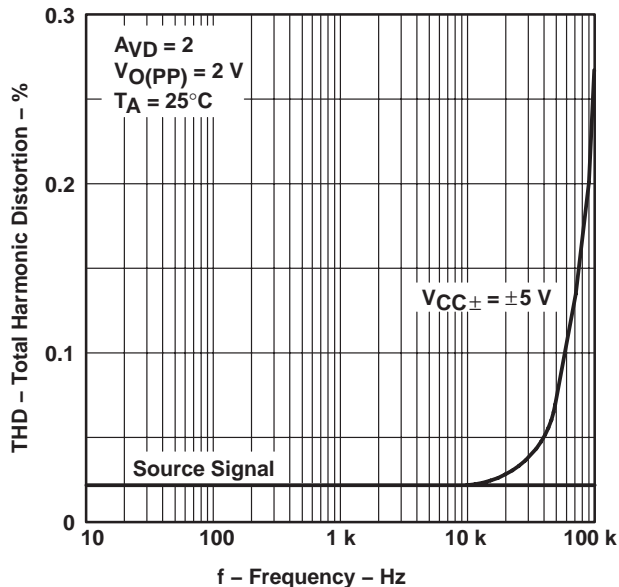

Figure 37

TOTAL HARMONIC DISTORTION  
 vs  
 FREQUENCY

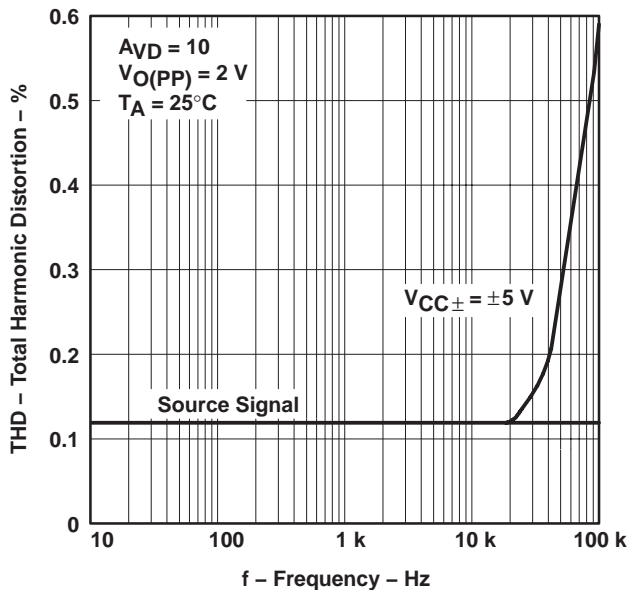

Figure 38

UNITY-GAIN BANDWIDTH  
 vs  
 SUPPLY VOLTAGE

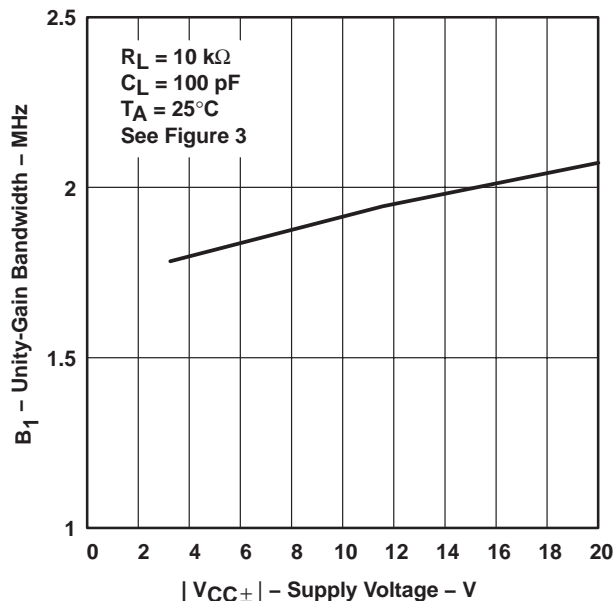

Figure 39

**TLE206x, TLE206xA, TLE206xB**  
**EXCALIBUR JFET-INPUT HIGH-OUTPUT-DRIVE**  
**μPOWER OPERATIONAL AMPLIFIERS**

SLOS193B – FEBRUARY 1997 – REVISED MAY 2004

**TYPICAL CHARACTERISTICS†**

**UNITY-GAIN BANDWIDTH**  
**vs**  
**FREE-AIR TEMPERATURE**



**Figure 40**

**PHASE MARGIN**  
**vs**  
**SUPPLY VOLTAGE**



**Figure 41**

**PHASE MARGIN**  
**vs**  
**LOAD CAPACITANCE**



**Figure 42**

**PHASE MARGIN**  
**vs**  
**FREE-AIR TEMPERATURE**



**Figure 43**

† Data at high and low temperatures are applicable only within the rated operating free-air temperature ranges of the various devices.





## APPLICATION INFORMATION

### input characteristics

The TLE206x, TLE206xA, and TLE206xB are specified with a minimum and a maximum input voltage that if exceeded at either input could cause the device to malfunction. Because of the extremely high input impedance and resulting low bias current requirements, the TLE206x, TLE206xA, and TLE206xB are well suited for low-level signal processing. However, leakage currents on printed-circuit boards and sockets can easily exceed bias current requirements and cause degradation in system performance. It is good practice to include guard rings around inputs (see Figure 44). These guards should be driven from a low-impedance source at the same voltage level as the common-mode input.



**Figure 44. Use of Guard Rings**

### TLE2061 input offset voltage nulling

The TLE2061 series offers external null pins that can be used to further reduce the input offset voltage. The circuit of Figure 45 can be connected as shown if the feature is desired. When external nulling is not needed, the null pins may be left unconnected.

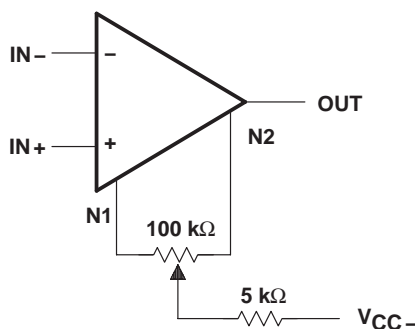

**Figure 45. Input Offset Voltage Nulling**



**PACKAGING INFORMATION**

Orderable Device	Status (1)	Package Type	Package Drawing	Pins	Package Qty	Eco Plan (2)	Lead finish/ Ball material (6)	MSL Peak Temp (3)	Op Temp (°C)	Device Marking (4/5)	Samples
5962-9080701M2A	ACTIVE	LCCC	FK	20	1	Non-RoHS & Green	SNPB	N / A for Pkg Type	-55 to 125	5962-9080701M2A TLE2061MFKB	<a href="#">Samples</a>
5962-9080701MPA	ACTIVE	CDIP	JG	8	1	Non-RoHS & Green	SNPB	N / A for Pkg Type	-55 to 125	9080701MPA TLE2061M	<a href="#">Samples</a>
5962-9080702Q2A	ACTIVE	LCCC	FK	20	1	Non-RoHS & Green	SNPB	N / A for Pkg Type	-55 to 125	5962-9080702Q2A TLE2061 AMFKB	<a href="#">Samples</a>
5962-9080702QPA	ACTIVE	CDIP	JG	8	1	Non-RoHS & Green	SNPB	N / A for Pkg Type	-55 to 125	9080702QPA TLE2061AM	<a href="#">Samples</a>
5962-9080703QPA	ACTIVE	CDIP	JG	8	1	Non-RoHS & Green	SNPB	N / A for Pkg Type	-55 to 125	9080703QPA TLE2061BM	<a href="#">Samples</a>
5962-9080801MPA	ACTIVE	CDIP	JG	8	1	Non-RoHS & Green	SNPB	N / A for Pkg Type	-55 to 125	9080801MPA TLE2062M	<a href="#">Samples</a>
5962-9080803QPA	ACTIVE	CDIP	JG	8	1	Non-RoHS & Green	SNPB	N / A for Pkg Type	-55 to 125	9080803QPA TLE2062BM	<a href="#">Samples</a>
5962-9080901M2A	ACTIVE	LCCC	FK	20	1	Non-RoHS & Green	SNPB	N / A for Pkg Type	-55 to 125	5962-9080901M2A TLE2064 MFKB	<a href="#">Samples</a>
5962-9080901MCA	ACTIVE	CDIP	J	14	1	Non-RoHS & Green	SNPB	N / A for Pkg Type	-55 to 125	5962-9080901MC A TLE2064MJB	<a href="#">Samples</a>
5962-9080902M2A	ACTIVE	LCCC	FK	20	1	Non-RoHS & Green	SNPB	N / A for Pkg Type	-55 to 125	5962-9080902M2A TLE2064A MFKB	<a href="#">Samples</a>
5962-9080902MDA	ACTIVE	CFP	W	14	1	Non-RoHS & Non-Green	SNPB	N / A for Pkg Type	-55 to 125	5962-9080902MD A TLE2064AMWB	<a href="#">Samples</a>
5962-9080903Q2A	ACTIVE	LCCC	FK	20	1	Non-RoHS & Green	SNPB	N / A for Pkg Type	-55 to 125	5962-9080903Q2A TLE2064 BMFKB	<a href="#">Samples</a>

Orderable Device	Status (1)	Package Type	Package Drawing	Pins	Package Qty	Eco Plan (2)	Lead finish/ Ball material (6)	MSL Peak Temp (3)	Op Temp (°C)	Device Marking (4/5)	Samples
5962-9080903QCA	ACTIVE	CDIP	J	14	1	Non-RoHS & Green	SNPB	N / A for Pkg Type	-55 to 125	5962-9080903QC A TLE2064BMJB	<a href="#">Samples</a>
TLE2061ACD	ACTIVE	SOIC	D	8	75	RoHS & Green	NIPDAU	Level-1-260C-UNLIM	0 to 70	2061AC	<a href="#">Samples</a>
TLE2061ACP	ACTIVE	PDIP	P	8	50	RoHS & Green	NIPDAU	N / A for Pkg Type	0 to 70	TLE2061AC	<a href="#">Samples</a>
TLE2061ACPE4	ACTIVE	PDIP	P	8	50	RoHS & Green	NIPDAU	N / A for Pkg Type	0 to 70	TLE2061AC	<a href="#">Samples</a>
TLE2061AID	ACTIVE	SOIC	D	8	75	RoHS & Green	NIPDAU	Level-1-260C-UNLIM	-40 to 85	2061AI	<a href="#">Samples</a>
TLE2061AIP	ACTIVE	PDIP	P	8	50	RoHS & Green	NIPDAU	N / A for Pkg Type	-40 to 85	TLE2061AI	<a href="#">Samples</a>
TLE2061AMFKB	ACTIVE	LCCC	FK	20	1	Non-RoHS & Green	SNPB	N / A for Pkg Type	-55 to 125	5962- 9080702Q2A TLE2061 AMFKB	<a href="#">Samples</a>
TLE2061AMJGB	ACTIVE	CDIP	JG	8	1	Non-RoHS & Green	SNPB	N / A for Pkg Type	-55 to 125	9080702QPA TLE2061AM	<a href="#">Samples</a>
TLE2061BMJGB	ACTIVE	CDIP	JG	8	1	Non-RoHS & Green	SNPB	N / A for Pkg Type	-55 to 125	9080703QPA TLE2061BM	<a href="#">Samples</a>
TLE2061CD	ACTIVE	SOIC	D	8	75	RoHS & Green	NIPDAU	Level-1-260C-UNLIM	0 to 70	2061C	<a href="#">Samples</a>
TLE2061CDR	ACTIVE	SOIC	D	8	2500	RoHS & Green	NIPDAU	Level-1-260C-UNLIM	0 to 70	2061C	<a href="#">Samples</a>
TLE2061CDRG4	ACTIVE	SOIC	D	8	2500	RoHS & Green	NIPDAU	Level-1-260C-UNLIM	0 to 70	2061C	<a href="#">Samples</a>
TLE2061CP	ACTIVE	PDIP	P	8	50	RoHS & Green	NIPDAU	N / A for Pkg Type	0 to 70	TLE2061CP	<a href="#">Samples</a>
TLE2061ID	ACTIVE	SOIC	D	8	75	RoHS & Green	NIPDAU	Level-1-260C-UNLIM	-40 to 85	2061I	<a href="#">Samples</a>
TLE2061IDR	ACTIVE	SOIC	D	8	2500	RoHS & Green	NIPDAU	Level-1-260C-UNLIM	-40 to 85	2061I	<a href="#">Samples</a>
TLE2061IP	ACTIVE	PDIP	P	8	50	RoHS & Green	NIPDAU	N / A for Pkg Type	-40 to 85	TLE2061IP	<a href="#">Samples</a>
TLE2061MD	ACTIVE	SOIC	D	8	75	RoHS & Green	NIPDAU	Level-1-260C-UNLIM	-55 to 125	2061M	<a href="#">Samples</a>
TLE2061MDG4	ACTIVE	SOIC	D	8	75	RoHS & Green	NIPDAU	Level-1-260C-UNLIM	-55 to 125	2061M	<a href="#">Samples</a>

Orderable Device	Status (1)	Package Type	Package Drawing	Pins	Package Qty	Eco Plan (2)	Lead finish/ Ball material (6)	MSL Peak Temp (3)	Op Temp (°C)	Device Marking (4/5)	Samples
TLE2061MFKB	ACTIVE	LCCC	FK	20	1	Non-RoHS & Green	SNPB	N / A for Pkg Type	-55 to 125	5962-9080701M2A TLE2061MFKB	<a href="#">Samples</a>
TLE2061MJGB	ACTIVE	CDIP	JG	8	1	Non-RoHS & Green	SNPB	N / A for Pkg Type	-55 to 125	9080701MPA TLE2061M	<a href="#">Samples</a>
TLE2062ACD	ACTIVE	SOIC	D	8	75	RoHS & Green	NIPDAU	Level-1-260C-UNLIM	0 to 70	2062AC	<a href="#">Samples</a>
TLE2062ACDG4	ACTIVE	SOIC	D	8	75	RoHS & Green	NIPDAU	Level-1-260C-UNLIM	0 to 70	2062AC	<a href="#">Samples</a>
TLE2062ACDR	ACTIVE	SOIC	D	8	2500	RoHS & Green	NIPDAU	Level-1-260C-UNLIM	0 to 70	2062AC	<a href="#">Samples</a>
TLE2062AID	ACTIVE	SOIC	D	8	75	RoHS & Green	NIPDAU	Level-1-260C-UNLIM	-40 to 85	2062AI	<a href="#">Samples</a>
TLE2062AIDG4	ACTIVE	SOIC	D	8	75	RoHS & Green	NIPDAU	Level-1-260C-UNLIM	-40 to 85	2062AI	<a href="#">Samples</a>
TLE2062AIDR	ACTIVE	SOIC	D	8	2500	RoHS & Green	NIPDAU	Level-1-260C-UNLIM	-40 to 85	2062AI	<a href="#">Samples</a>
TLE2062AMD	ACTIVE	SOIC	D	8	75	RoHS & Green	NIPDAU	Level-1-260C-UNLIM	-55 to 125	2062AM	<a href="#">Samples</a>
TLE2062AMDG4	ACTIVE	SOIC	D	8	75	RoHS & Green	NIPDAU	Level-1-260C-UNLIM	-55 to 125	2062AM	<a href="#">Samples</a>
TLE2062AMDR	ACTIVE	SOIC	D	8	2500	RoHS & Green	NIPDAU	Level-1-260C-UNLIM	-55 to 125	2062AM	<a href="#">Samples</a>
TLE2062AMJG	ACTIVE	CDIP	JG	8	1	Non-RoHS & Green	SNPB	N / A for Pkg Type	-55 to 125	TLE2062 AMJG	<a href="#">Samples</a>
TLE2062BMJG	ACTIVE	CDIP	JG	8	1	Non-RoHS & Green	SNPB	N / A for Pkg Type	-55 to 125	TLE2062 BMJG	<a href="#">Samples</a>
TLE2062BMJGB	ACTIVE	CDIP	JG	8	1	Non-RoHS & Green	SNPB	N / A for Pkg Type	-55 to 125	9080803QPA TLE2062BM	<a href="#">Samples</a>
TLE2062CD	ACTIVE	SOIC	D	8	75	RoHS & Green	NIPDAU	Level-1-260C-UNLIM	0 to 70	2062C	<a href="#">Samples</a>
TLE2062CDR	ACTIVE	SOIC	D	8	2500	RoHS & Green	NIPDAU	Level-1-260C-UNLIM	0 to 70	2062C	<a href="#">Samples</a>
TLE2062CDRG4	ACTIVE	SOIC	D	8	2500	RoHS & Green	NIPDAU	Level-1-260C-UNLIM	0 to 70	2062C	<a href="#">Samples</a>
TLE2062CP	ACTIVE	PDIP	P	8	50	RoHS & Green	NIPDAU	N / A for Pkg Type	0 to 70	TLE2062CP	<a href="#">Samples</a>
TLE2062ID	ACTIVE	SOIC	D	8	75	RoHS & Green	NIPDAU	Level-1-260C-UNLIM	-40 to 85	2062I	<a href="#">Samples</a>

Orderable Device	Status (1)	Package Type	Package Drawing	Pins	Package Qty	Eco Plan (2)	Lead finish/ Ball material (6)	MSL Peak Temp (3)	Op Temp (°C)	Device Marking (4/5)	Samples
TLE2062IDG4	ACTIVE	SOIC	D	8	75	RoHS & Green	NIPDAU	Level-1-260C-UNLIM	-40 to 85	2062I	<a href="#">Samples</a>
TLE2062IDR	ACTIVE	SOIC	D	8	2500	RoHS & Green	NIPDAU	Level-1-260C-UNLIM	-40 to 85	2062I	<a href="#">Samples</a>
TLE2062IP	ACTIVE	PDIP	P	8	50	RoHS & Green	NIPDAU	N / A for Pkg Type	-40 to 85	TLE2062IP	<a href="#">Samples</a>
TLE2062MD	ACTIVE	SOIC	D	8	75	RoHS & Green	NIPDAU	Level-1-260C-UNLIM	-55 to 125	2062M	<a href="#">Samples</a>
TLE2062MDG4	ACTIVE	SOIC	D	8	75	RoHS & Green	NIPDAU	Level-1-260C-UNLIM	-55 to 125	2062M	<a href="#">Samples</a>
TLE2062MJG	ACTIVE	CDIP	JG	8	1	Non-RoHS & Green	SNPB	N / A for Pkg Type	-55 to 125	TLE2062MJG	<a href="#">Samples</a>
TLE2062MJGB	ACTIVE	CDIP	JG	8	1	Non-RoHS & Green	SNPB	N / A for Pkg Type	-55 to 125	9080801MPA TLE2062M	<a href="#">Samples</a>
TLE2064ACD	ACTIVE	SOIC	D	14	50	RoHS & Green	NIPDAU	Level-1-260C-UNLIM	0 to 70	2064AC	<a href="#">Samples</a>
TLE2064ACDR	ACTIVE	SOIC	D	14	2500	RoHS & Green	NIPDAU	Level-1-260C-UNLIM		2064AC	<a href="#">Samples</a>
TLE2064ACN	ACTIVE	PDIP	N	14	25	RoHS & Green	NIPDAU	N / A for Pkg Type		TLE2064ACN	<a href="#">Samples</a>
TLE2064AID	ACTIVE	SOIC	D	14	50	RoHS & Green	NIPDAU	Level-1-260C-UNLIM	-40 to 85	2064AI	<a href="#">Samples</a>
TLE2064AIDG4	ACTIVE	SOIC	D	14	50	RoHS & Green	NIPDAU	Level-1-260C-UNLIM	-40 to 85	2064AI	<a href="#">Samples</a>
TLE2064AIDR	ACTIVE	SOIC	D	14	2500	RoHS & Green	NIPDAU	Level-1-260C-UNLIM		2064AI	<a href="#">Samples</a>
TLE2064AMD	ACTIVE	SOIC	D	14	50	RoHS & Green	NIPDAU	Level-1-260C-UNLIM	-55 to 125	2064AM	<a href="#">Samples</a>
TLE2064AMDG4	ACTIVE	SOIC	D	14	50	RoHS & Green	NIPDAU	Level-1-260C-UNLIM		2064AM	<a href="#">Samples</a>
TLE2064AMDR	ACTIVE	SOIC	D	14	2500	RoHS & Green	NIPDAU	Level-1-260C-UNLIM	-55 to 125	2064AM	<a href="#">Samples</a>
TLE2064AMDRG4	ACTIVE	SOIC	D	14	2500	RoHS & Green	NIPDAU	Level-1-260C-UNLIM		2064AM	<a href="#">Samples</a>
TLE2064AMFKB	ACTIVE	LCCC	FK	20	1	Non-RoHS & Green	SNPB	N / A for Pkg Type	-55 to 125	5962- 9080902M2A TLE2064A MFKB	<a href="#">Samples</a>
TLE2064AMJ	ACTIVE	CDIP	J	14	1	Non-RoHS & Green	SNPB	N / A for Pkg Type	-55 to 125	TLE2064AMJ	<a href="#">Samples</a>

Orderable Device	Status (1)	Package Type	Package Drawing	Pins	Package Qty	Eco Plan (2)	Lead finish/ Ball material (6)	MSL Peak Temp (3)	Op Temp (°C)	Device Marking (4/5)	Samples
TLE2064AMWB	ACTIVE	CFP	W	14	1	Non-RoHS & Non-Green	SNPB	N / A for Pkg Type	-55 to 125	5962-9080902MD A TLE2064AMWB	<a href="#">Samples</a>
TLE2064BMFKB	ACTIVE	LCCC	FK	20	1	Non-RoHS & Green	SNPB	N / A for Pkg Type	-55 to 125	5962-9080903Q2A TLE2064 BMFKB	<a href="#">Samples</a>
TLE2064BMJ	ACTIVE	CDIP	J	14	1	Non-RoHS & Green	SNPB	N / A for Pkg Type	-55 to 125	TLE2064BMJ	<a href="#">Samples</a>
TLE2064BMJB	ACTIVE	CDIP	J	14	1	Non-RoHS & Green	SNPB	N / A for Pkg Type	-55 to 125	5962-9080903QC A TLE2064BMJB	<a href="#">Samples</a>
TLE2064CD	ACTIVE	SOIC	D	14	50	RoHS & Green	NIPDAU	Level-1-260C-UNLIM	0 to 70	TLE2064C	<a href="#">Samples</a>
TLE2064CDG4	ACTIVE	SOIC	D	14	50	RoHS & Green	NIPDAU	Level-1-260C-UNLIM	0 to 70	TLE2064C	<a href="#">Samples</a>
TLE2064CDR	ACTIVE	SOIC	D	14	2500	RoHS & Green	NIPDAU	Level-1-260C-UNLIM	0 to 70	TLE2064C	<a href="#">Samples</a>
TLE2064CDRG4	ACTIVE	SOIC	D	14	2500	RoHS & Green	NIPDAU	Level-1-260C-UNLIM	0 to 70	TLE2064C	<a href="#">Samples</a>
TLE2064CN	ACTIVE	PDIP	N	14	25	RoHS & Green	NIPDAU	N / A for Pkg Type	0 to 70	TLE2064CN	<a href="#">Samples</a>
TLE2064CNE4	ACTIVE	PDIP	N	14	25	RoHS & Green	NIPDAU	N / A for Pkg Type	0 to 70	TLE2064CN	<a href="#">Samples</a>
TLE2064ID	ACTIVE	SOIC	D	14	50	RoHS & Green	NIPDAU	Level-1-260C-UNLIM	-40 to 85	TLE2064I	<a href="#">Samples</a>
TLE2064IDR	ACTIVE	SOIC	D	14	2500	RoHS & Green	NIPDAU	Level-1-260C-UNLIM	-40 to 85	TLE2064I	<a href="#">Samples</a>
TLE2064IN	ACTIVE	PDIP	N	14	25	RoHS & Green	NIPDAU	N / A for Pkg Type	-40 to 85	TLE2064IN	<a href="#">Samples</a>
TLE2064INE4	ACTIVE	PDIP	N	14	25	RoHS & Green	NIPDAU	N / A for Pkg Type	-40 to 85	TLE2064IN	<a href="#">Samples</a>
TLE2064MD	ACTIVE	SOIC	D	14	50	RoHS & Green	NIPDAU	Level-1-260C-UNLIM	-55 to 125	TLE2064M	<a href="#">Samples</a>
TLE2064MDG4	ACTIVE	SOIC	D	14	50	RoHS & Green	NIPDAU	Level-1-260C-UNLIM		T2064M	<a href="#">Samples</a>
TLE2064MDR	ACTIVE	SOIC	D	14	2500	RoHS & Green	NIPDAU	Level-1-260C-UNLIM	-55 to 125	TLE2064M	<a href="#">Samples</a>
TLE2064MDRG4	ACTIVE	SOIC	D	14	2500	RoHS & Green	NIPDAU	Level-1-260C-UNLIM		T2064M	<a href="#">Samples</a>

Orderable Device	Status (1)	Package Type	Package Drawing	Pins	Package Qty	Eco Plan (2)	Lead finish/ Ball material (6)	MSL Peak Temp (3)	Op Temp (°C)	Device Marking (4/5)	Samples
TLE2064MFKB	ACTIVE	LCCC	FK	20	1	Non-RoHS & Green	SNPB	N / A for Pkg Type	-55 to 125	5962-9080901M2A TLE2064 MFKB	<a href="#">Samples</a>
TLE2064MJ	ACTIVE	CDIP	J	14	1	Non-RoHS & Green	SNPB	N / A for Pkg Type	-55 to 125	TLE2064MJ	<a href="#">Samples</a>
TLE2064MJB	ACTIVE	CDIP	J	14	1	Non-RoHS & Green	SNPB	N / A for Pkg Type	-55 to 125	5962-9080901MC A TLE2064MJB	<a href="#">Samples</a>

(1) The marketing status values are defined as follows:

**ACTIVE:** Product device recommended for new designs.

**LIFEBUY:** TI has announced that the device will be discontinued, and a lifetime-buy period is in effect.

**NRND:** Not recommended for new designs. Device is in production to support existing customers, but TI does not recommend using this part in a new design.

**PREVIEW:** Device has been announced but is not in production. Samples may or may not be available.

**OBSELETE:** TI has discontinued the production of the device.

(2) **RoHS:** TI defines "RoHS" to mean semiconductor products that are compliant with the current EU RoHS requirements for all 10 RoHS substances, including the requirement that RoHS substance do not exceed 0.1% by weight in homogeneous materials. Where designed to be soldered at high temperatures, "RoHS" products are suitable for use in specified lead-free processes. TI may reference these types of products as "Pb-Free".

**RoHS Exempt:** TI defines "RoHS Exempt" to mean products that contain lead but are compliant with EU RoHS pursuant to a specific EU RoHS exemption.

**Green:** TI defines "Green" to mean the content of Chlorine (Cl) and Bromine (Br) based flame retardants meet JS709B low halogen requirements of <=1000ppm threshold. Antimony trioxide based flame retardants must also meet the <=1000ppm threshold requirement.

(3) MSL, Peak Temp. - The Moisture Sensitivity Level rating according to the JEDEC industry standard classifications, and peak solder temperature.

(4) There may be additional marking, which relates to the logo, the lot trace code information, or the environmental category on the device.

(5) Multiple Device Markings will be inside parentheses. Only one Device Marking contained in parentheses and separated by a "-" will appear on a device. If a line is indented then it is a continuation of the previous line and the two combined represent the entire Device Marking for that device.

(6) Lead finish/Ball material - Orderable Devices may have multiple material finish options. Finish options are separated by a vertical ruled line. Lead finish/Ball material values may wrap to two lines if the finish value exceeds the maximum column width.

**Important Information and Disclaimer:**The information provided on this page represents TI's knowledge and belief as of the date that it is provided. TI bases its knowledge and belief on information provided by third parties, and makes no representation or warranty as to the accuracy of such information. Efforts are underway to better integrate information from third parties. TI has taken and



continues to take reasonable steps to provide representative and accurate information but may not have conducted destructive testing or chemical analysis on incoming materials and chemicals. TI and TI suppliers consider certain information to be proprietary, and thus CAS numbers and other limited information may not be available for release.

In no event shall TI's liability arising out of such information exceed the total purchase price of the TI part(s) at issue in this document sold by TI to Customer on an annual basis.

**OTHER QUALIFIED VERSIONS OF TLE2061, TLE2061A, TLE2061AM, TLE2061M, TLE2062, TLE2062A, TLE2062AM, TLE2062M, TLE2064, TLE2064A, TLE2064AM, TLE2064M :**

- Catalog : [TLE2061A](#), [TLE2061](#), [TLE2062A](#), [TLE2062](#), [TLE2064A](#), [TLE2064](#)
- Military : [TLE2061M](#), [TLE2061AM](#), [TLE2062M](#), [TLE2062AM](#), [TLE2064M](#), [TLE2064AM](#)

NOTE: Qualified Version Definitions:

- Catalog - TI's standard catalog product
- Military - QML certified for Military and Defense Applications

**TAPE AND REEL INFORMATION**

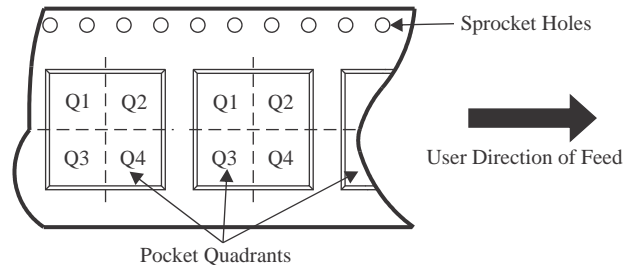
**QUADRANT ASSIGNMENTS FOR PIN 1 ORIENTATION IN TAPE**

\*All dimensions are nominal

Device	Package Type	Package Drawing	Pins	SPQ	Reel Diameter (mm)	Reel Width W1 (mm)	A0 (mm)	B0 (mm)	K0 (mm)	P1 (mm)	W (mm)	Pin1 Quadrant
TLE2061CDR	SOIC	D	8	2500	330.0	12.4	6.4	5.2	2.1	8.0	12.0	Q1
TLE2061IDR	SOIC	D	8	2500	330.0	12.4	6.4	5.2	2.1	8.0	12.0	Q1
TLE2062ACDR	SOIC	D	8	2500	330.0	12.4	6.4	5.2	2.1	8.0	12.0	Q1
TLE2062AIDR	SOIC	D	8	2500	330.0	12.4	6.4	5.2	2.1	8.0	12.0	Q1
TLE2062AMDR	SOIC	D	8	2500	330.0	12.4	6.4	5.2	2.1	8.0	12.0	Q1
TLE2062CDR	SOIC	D	8	2500	330.0	12.4	6.4	5.2	2.1	8.0	12.0	Q1
TLE2062IDR	SOIC	D	8	2500	330.0	12.4	6.4	5.2	2.1	8.0	12.0	Q1
TLE2064ACDR	SOIC	D	14	2500	330.0	16.4	6.5	9.0	2.1	8.0	16.0	Q1
TLE2064AIDR	SOIC	D	14	2500	330.0	16.4	6.5	9.0	2.1	8.0	16.0	Q1
TLE2064AMDR	SOIC	D	14	2500	330.0	16.4	6.5	9.0	2.1	8.0	16.0	Q1
TLE2064CDR	SOIC	D	14	2500	330.0	16.4	6.5	9.0	2.1	8.0	16.0	Q1
TLE2064IDR	SOIC	D	14	2500	330.0	16.4	6.5	9.0	2.1	8.0	16.0	Q1
TLE2064MDR	SOIC	D	14	2500	330.0	16.4	6.5	9.0	2.1	8.0	16.0	Q1

**TAPE AND REEL BOX DIMENSIONS**

\*All dimensions are nominal

Device	Package Type	Package Drawing	Pins	SPQ	Length (mm)	Width (mm)	Height (mm)
TLE2061CDR	SOIC	D	8	2500	340.5	336.1	25.0
TLE2061IDR	SOIC	D	8	2500	340.5	336.1	25.0
TLE2062ACDR	SOIC	D	8	2500	340.5	336.1	25.0
TLE2062AIDR	SOIC	D	8	2500	340.5	336.1	25.0
TLE2062AMDR	SOIC	D	8	2500	350.0	350.0	43.0
TLE2062CDR	SOIC	D	8	2500	340.5	336.1	25.0
TLE2062IDR	SOIC	D	8	2500	340.5	336.1	25.0
TLE2064ACDR	SOIC	D	14	2500	350.0	350.0	43.0
TLE2064AIDR	SOIC	D	14	2500	350.0	350.0	43.0
TLE2064AMDR	SOIC	D	14	2500	350.0	350.0	43.0
TLE2064CDR	SOIC	D	14	2500	350.0	350.0	43.0
TLE2064IDR	SOIC	D	14	2500	350.0	350.0	43.0
TLE2064MDR	SOIC	D	14	2500	350.0	350.0	43.0

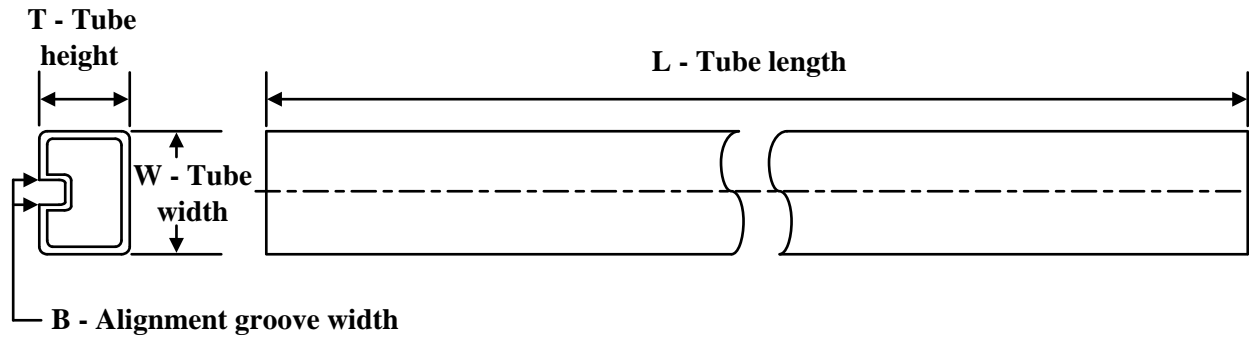
**TUBE**

\*All dimensions are nominal

Device	Package Name	Package Type	Pins	SPQ	L (mm)	W (mm)	T (µm)	B (mm)
5962-9080701M2A	FK	LCCC	20	1	506.98	12.06	2030	NA
5962-9080702Q2A	FK	LCCC	20	1	506.98	12.06	2030	NA
5962-9080901M2A	FK	LCCC	20	1	506.98	12.06	2030	NA
5962-9080902M2A	FK	LCCC	20	1	506.98	12.06	2030	NA
5962-9080902MDA	W	CFP	14	1	506.98	26.16	6220	NA
5962-9080903Q2A	FK	LCCC	20	1	506.98	12.06	2030	NA
TLE2061ACD	D	SOIC	8	75	507	8	3940	4.32
TLE2061ACD	D	SOIC	8	75	505.46	6.76	3810	4
TLE2061ACP	P	PDIP	8	50	506	13.97	11230	4.32
TLE2061ACPE4	P	PDIP	8	50	506	13.97	11230	4.32
TLE2061AID	D	SOIC	8	75	505.46	6.76	3810	4
TLE2061AID	D	SOIC	8	75	507	8	3940	4.32
TLE2061AIP	P	PDIP	8	50	506	13.97	11230	4.32
TLE2061AMFKB	FK	LCCC	20	1	506.98	12.06	2030	NA
TLE2061CD	D	SOIC	8	75	507	8	3940	4.32
TLE2061CD	D	SOIC	8	75	505.46	6.76	3810	4
TLE2061CP	P	PDIP	8	50	506	13.97	11230	4.32
TLE2061ID	D	SOIC	8	75	507	8	3940	4.32
TLE2061ID	D	SOIC	8	75	505.46	6.76	3810	4
TLE2061IP	P	PDIP	8	50	506	13.97	11230	4.32
TLE2061MD	D	SOIC	8	75	505.46	6.76	3810	4
TLE2061MDG4	D	SOIC	8	75	505.46	6.76	3810	4
TLE2061MFKB	FK	LCCC	20	1	506.98	12.06	2030	NA
TLE2062ACD	D	SOIC	8	75	507	8	3940	4.32
TLE2062ACD	D	SOIC	8	75	505.46	6.76	3810	4
TLE2062ACDG4	D	SOIC	8	75	507	8	3940	4.32
TLE2062ACDG4	D	SOIC	8	75	505.46	6.76	3810	4
TLE2062AID	D	SOIC	8	75	505.46	6.76	3810	4
TLE2062AID	D	SOIC	8	75	507	8	3940	4.32

Device	Package Name	Package Type	Pins	SPQ	L (mm)	W (mm)	T (µm)	B (mm)
TLE2062AIDG4	D	SOIC	8	75	507	8	3940	4.32
TLE2062AIDG4	D	SOIC	8	75	505.46	6.76	3810	4
TLE2062AMD	D	SOIC	8	75	505.46	6.76	3810	4
TLE2062AMDG4	D	SOIC	8	75	505.46	6.76	3810	4
TLE2062CD	D	SOIC	8	75	507	8	3940	4.32
TLE2062CD	D	SOIC	8	75	505.46	6.76	3810	4
TLE2062CP	P	PDIP	8	50	506	13.97	11230	4.32
TLE2062ID	D	SOIC	8	75	507	8	3940	4.32
TLE2062ID	D	SOIC	8	75	505.46	6.76	3810	4
TLE2062IDG4	D	SOIC	8	75	505.46	6.76	3810	4
TLE2062IDG4	D	SOIC	8	75	507	8	3940	4.32
TLE2062IP	P	PDIP	8	50	506	13.97	11230	4.32
TLE2062MD	D	SOIC	8	75	505.46	6.76	3810	4
TLE2062MDG4	D	SOIC	8	75	505.46	6.76	3810	4
TLE2064ACD	D	SOIC	14	50	505.46	6.76	3810	4
TLE2064ACN	N	PDIP	14	25	506	13.97	11230	4.32
TLE2064AID	D	SOIC	14	50	505.46	6.76	3810	4
TLE2064AIDG4	D	SOIC	14	50	505.46	6.76	3810	4
TLE2064AMD	D	SOIC	14	50	505.46	6.76	3810	4
TLE2064AMDG4	D	SOIC	14	50	505.46	6.76	3810	4
TLE2064AMFKB	FK	LCCC	20	1	506.98	12.06	2030	NA
TLE2064AMWB	W	CFP	14	1	506.98	26.16	6220	NA
TLE2064BMFKB	FK	LCCC	20	1	506.98	12.06	2030	NA
TLE2064CD	D	SOIC	14	50	505.46	6.76	3810	4
TLE2064CDG4	D	SOIC	14	50	505.46	6.76	3810	4
TLE2064CN	N	PDIP	14	25	506	13.97	11230	4.32
TLE2064CNE4	N	PDIP	14	25	506	13.97	11230	4.32
TLE2064ID	D	SOIC	14	50	505.46	6.76	3810	4
TLE2064IN	N	PDIP	14	25	506	13.97	11230	4.32
TLE2064INE4	N	PDIP	14	25	506	13.97	11230	4.32
TLE2064MD	D	SOIC	14	50	505.46	6.76	3810	4
TLE2064MDG4	D	SOIC	14	50	505.46	6.76	3810	4
TLE2064MFKB	FK	LCCC	20	1	506.98	12.06	2030	NA

W (R-GDFP-F14)

CERAMIC DUAL FLATPACK



- NOTES:
- A. All linear dimensions are in inches (millimeters).
  - B. This drawing is subject to change without notice.
  - C. This package can be hermetically sealed with a ceramic lid using glass frit.
  - D. Index point is provided on cap for terminal identification only.
  - E. Falls within MIL STD 1835 GDFP1-F14

J 14

**GENERIC PACKAGE VIEW**  
**CDIP - 5.08 mm max height**  
CERAMIC DUAL IN LINE PACKAGE



Images above are just a representation of the package family, actual package may vary.  
Refer to the product data sheet for package details.

4040083-5/G

# J0014A



## PACKAGE OUTLINE

CDIP - 5.08 mm max height

CERAMIC DUAL IN LINE PACKAGE



4214771/A 05/2017

### NOTES:

1. All controlling linear dimensions are in inches. Dimensions in brackets are in millimeters. Any dimension in brackets or parenthesis are for reference only. Dimensioning and tolerancing per ASME Y14.5M.
2. This drawing is subject to change without notice.
3. This package is hermetically sealed with a ceramic lid using glass frit.
4. Index point is provided on cap for terminal identification only and on press ceramic glass frit seal only.
5. Falls within MIL-STD-1835 and GDIP1-T14.



# EXAMPLE BOARD LAYOUT

J0014A

CDIP - 5.08 mm max height

CERAMIC DUAL IN LINE PACKAGE



LAND PATTERN EXAMPLE  
NON-SOLDER MASK DEFINED  
SCALE: 5X



4214771/A 05/2017

D (R-PDSO-G14)

PLASTIC SMALL OUTLINE



4040047-5/M 06/11

- NOTES:
- A. All linear dimensions are in inches (millimeters).
  - B. This drawing is subject to change without notice.
  -  Body length does not include mold flash, protrusions, or gate burrs. Mold flash, protrusions, or gate burrs shall not exceed 0.006 (0,15) each side.
  -  Body width does not include interlead flash. Interlead flash shall not exceed 0.017 (0,43) each side.
  - E. Reference JEDEC MS-012 variation AB.



D0008A

# PACKAGE OUTLINE

SOIC - 1.75 mm max height

SMALL OUTLINE INTEGRATED CIRCUIT



4214825/C 02/2019

NOTES:

- Linear dimensions are in inches [millimeters]. Dimensions in parenthesis are for reference only. Controlling dimensions are in inches. Dimensioning and tolerancing per ASME Y14.5M.
- This drawing is subject to change without notice.
- This dimension does not include mold flash, protrusions, or gate burrs. Mold flash, protrusions, or gate burrs shall not exceed .006 [0.15] per side.
- This dimension does not include interlead flash.
- Reference JEDEC registration MS-012, variation AA.

# EXAMPLE BOARD LAYOUT

D0008A

SOIC - 1.75 mm max height

SMALL OUTLINE INTEGRATED CIRCUIT



LAND PATTERN EXAMPLE  
EXPOSED METAL SHOWN  
SCALE:8X



SOLDER MASK DETAILS

4214825/C 02/2019

NOTES: (continued)

6. Publication IPC-7351 may have alternate designs.

7. Solder mask tolerances between and around signal pads can vary based on board fabrication site.

# EXAMPLE STENCIL DESIGN

D0008A

SOIC - 1.75 mm max height

SMALL OUTLINE INTEGRATED CIRCUIT



SOLDER PASTE EXAMPLE  
BASED ON .005 INCH [0.125 MM] THICK STENCIL  
SCALE:8X

4214825/C 02/2019

NOTES: (continued)

8. Laser cutting apertures with trapezoidal walls and rounded corners may offer better paste release. IPC-7525 may have alternate design recommendations.
9. Board assembly site may have different recommendations for stencil design.

JG (R-GDIP-T8)

CERAMIC DUAL-IN-LINE



- NOTES: A. All linear dimensions are in inches (millimeters).  
 B. This drawing is subject to change without notice.  
 C. This package can be hermetically sealed with a ceramic lid using glass frit.  
 D. Index point is provided on cap for terminal identification.  
 E. Falls within MIL STD 1835 GDIP1-T8

P (R-PDIP-T8)

PLASTIC DUAL-IN-LINE PACKAGE



- NOTES:
- A. All linear dimensions are in inches (millimeters).
  - B. This drawing is subject to change without notice.
  - C. Falls within JEDEC MS-001 variation BA.

N (R-PDIP-T\*\*)

PLASTIC DUAL-IN-LINE PACKAGE

16 PINS SHOWN



- NOTES:
- A. All linear dimensions are in inches (millimeters).
  - B. This drawing is subject to change without notice.
  - $\triangle C$  Falls within JEDEC MS-001, except 18 and 20 pin minimum body length (Dim A).
  - $\triangle D$  The 20 pin end lead shoulder width is a vendor option, either half or full width.

4040049/E 12/2002



## IMPORTANT NOTICE AND DISCLAIMER

TI PROVIDES TECHNICAL AND RELIABILITY DATA (INCLUDING DATA SHEETS), DESIGN RESOURCES (INCLUDING REFERENCE DESIGNS), APPLICATION OR OTHER DESIGN ADVICE, WEB TOOLS, SAFETY INFORMATION, AND OTHER RESOURCES "AS IS" AND WITH ALL FAULTS, AND DISCLAIMS ALL WARRANTIES, EXPRESS AND IMPLIED, INCLUDING WITHOUT LIMITATION ANY IMPLIED WARRANTIES OF MERCHANTABILITY, FITNESS FOR A PARTICULAR PURPOSE OR NON-INFRINGEMENT OF THIRD PARTY INTELLECTUAL PROPERTY RIGHTS.

These resources are intended for skilled developers designing with TI products. You are solely responsible for (1) selecting the appropriate TI products for your application, (2) designing, validating and testing your application, and (3) ensuring your application meets applicable standards, and any other safety, security, regulatory or other requirements.

These resources are subject to change without notice. TI grants you permission to use these resources only for development of an application that uses the TI products described in the resource. Other reproduction and display of these resources is prohibited. No license is granted to any other TI intellectual property right or to any third party intellectual property right. TI disclaims responsibility for, and you will fully indemnify TI and its representatives against, any claims, damages, costs, losses, and liabilities arising out of your use of these resources.

TI's products are provided subject to [TI's Terms of Sale](#) or other applicable terms available either on [ti.com](https://www.ti.com) or provided in conjunction with such TI products. TI's provision of these resources does not expand or otherwise alter TI's applicable warranties or warranty disclaimers for TI products.

TI objects to and rejects any additional or different terms you may have proposed.

Mailing Address: Texas Instruments, Post Office Box 655303, Dallas, Texas 75265  
Copyright © 2023, Texas Instruments Incorporated

## X-ON Electronics

Largest Supplier of Electrical and Electronic Components

*Click to view similar products for [Operational Amplifiers - Op Amps](#) category:*

*Click to view products by [Texas Instruments](#) manufacturer:*

Other Similar products are found below :

[430227FB](#) [LT1678IS8](#) [NCV33202DMR2G](#) [NJM324E](#) [M38510/13101BPA](#) [NTE925](#) [AZV358MTR-G1](#) [AP4310AUMTR-AG1](#)  
[AZV358MMTR-G1](#) [SCY33178DR2G](#) [NCV20034DR2G](#) [NTE778S](#) [NTE871](#) [NTE937](#) [NJU7057RB1-TE2](#) [SCY6358ADR2G](#)  
[NJM2904CRB1-TE1](#) [UPC4570G2-E1-A](#) [UPC4741G2-E1-A](#) [NJM8532RB1-TE1](#) [EL2250CS](#) [EL5100IS](#) [EL5104IS](#) [EL5127CY](#) [EL5127CZ](#)  
[EL5133IW](#) [EL5152IS](#) [EL5156IS](#) [EL5162IS](#) [EL5202IY](#) [EL5203IY](#) [EL5204IY](#) [EL5210CS](#) [EL5210CZ](#) [EL5211IYE](#) [EL5220CY](#)  
[EL5223CLZ](#) [EL5223CR](#) [EL5224ILZ](#) [EL5227CLZ](#) [EL5227CRZ](#) [EL5244CS](#) [EL5246CS](#) [EL5246CSZ](#) [EL5250IY](#) [EL5251IS](#) [EL5257IS](#)  
[EL5260IY](#) [EL5261IS](#) [EL5300IU](#)