

TLV700xx-Q1

用于便携式设备的 200mA、低 I_Q 、低压降稳压器 (LDO)

1 特性

- 符合汽车类应用的标准中。
- 具有符合 AEC-Q100 标准的下列特性：
 - 器件温度 1 级：-40°C 至 125°C 的环境运行温度范围
 - 器件人体放电模型 (HBM) 静电防护 (ESD) 分类等级 H2
 - 器件 CDM ESD 分类等级 C4B
- 2% 精度
- 低 I_Q ：31 μ A
- 固定输出电压组合（可能为 1.9V 至 4.8V）
- 高 PSRR：频率 1kHz 时为 68dB
- 可实现稳定运行的有效电容值：0.1 μ F
- 热关断及过流保护功能
- 锁存性能可达 100mA
符合 AEC-Q100 I 级标准
- 采用 SOT-23-5 和 SC70 封装

2 应用

- 汽车摄像机模块
- 图像传感器电源
- 微处理器轨
- 汽车信息娱乐音响主机
- 汽车车身电子设备

3 说明

TLV700xx-Q1 系列低压降线性稳压器 (LDO) 具有较低的静态电流，并且线路和负载瞬态性能出色。这些 LDO 适用于功耗敏感型应用时，会限制上部输出摆幅。高精度带隙与误差放大器支持 2% 总误差精度。低输出噪声、极高的电源抑制比 (PSRR) 和低压降电压使得这一系列器件成为大多数电池供电类手持设备的理想选择。所有器件版本都具有热关断和电流限值以保证安全。

此外，这些器件还能在采用仅 0.1 μ F 的有效输出电容时保持稳定。这一特性允许使用具有较高偏置电压和温度降额的成本有效电容器。这些器件在不产生输出负载的情况下可调节至特定的精度。

TLV700xx-Q1 LDO 可采用 SOT-23-5 和 SC70 封装。

器件信息⁽¹⁾

器件型号	封装	封装尺寸 (标称值)
TLV700xx-Q1	SC70 (5)	2.00mm x 1.25mm
	小外形尺寸晶体管 (SOT) (5)	2.90mm x 1.60mm

(1) 如需了解所有可用封装，请参阅数据表末尾的可订购产品附录。

典型应用电路（固定电压版本）

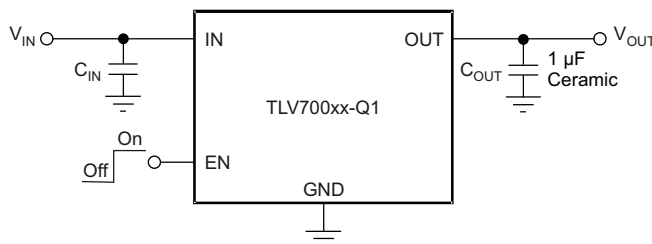

目录

1	特性	1	8	Application and Implementation	12
2	应用	1	8.1	Application Information.....	12
3	说明	1	8.2	Typical Application	13
4	修订历史记录	2	9	Power Supply Recommendations	14
5	Pin Configuration and Functions	3	10	Layout.....	15
6	Specifications.....	3	10.1	Layout Guidelines	15
6.1	Absolute Maximum Ratings	3	10.2	Board Layout Recommendations to Improve PSRR and Noise Performance	15
6.2	ESD Ratings.....	3	10.3	Layout Example	15
6.3	Recommended Operating Conditions.....	4	11	器件和文档支持	16
6.4	Thermal Information	4	11.1	文档支持	16
6.5	Electrical Characteristics.....	5	11.2	接收文档更新通知	16
6.6	Typical Characteristics	6	11.3	社区资源	16
7	Detailed Description	10	11.4	商标	16
7.1	Overview	10	11.5	静电放电警告	16
7.2	Functional Block Diagram	10	11.6	术语表	16
7.3	Feature Description.....	10	12	机械、封装和可订购信息	16
7.4	Device Functional Modes.....	11			

4 修订历史记录

Changes from Revision B (October 2016) to Revision C	Page
• 已添加 在文档中添加了 DCK (SC70) 封装；请注意，TLV70025-Q1 和 TLV70033-Q1 之前列在 SLVSA61 中.....	1
• 已更改 在特性部分中，将固定输出电压项目符号更改为固定输出电压组合	1
• 已更改 更改了 说明 部分的最后一段，以将 SC70 封装包括在内	1
• 已添加 将 SC70 行添加到了器件信息表	1
• Added DCK package to <i>Pin Configuration and Functions</i> section	3
• Added T_J parameter to <i>Absolute Maximum Ratings</i> table.....	3
• Changed T_J parameter to T_A in <i>Recommended Operating Conditions</i> table and changed <i>junction</i> to <i>ambient</i> in parameter name	4
• Added <i>TLV70033-Q1 PSRR Ratio</i> figure	8

Changes from Revision A (September 2016) to Revision B	Page
• Changed maximum specification of V_{EN} parameter in <i>Absolute Maximum Ratings</i> table	3
• Changed I_{OUT} parameter name in <i>Recommended Operating Conditions</i> table	4

Changes from Original (July 2016) to Revision A	Page
• 已发布为量产数据；请注意，TLV70028QDDCRQ1 和 TLV70032QDDCRQ1 之前已列于 SLVSA61	1

5 Pin Configuration and Functions

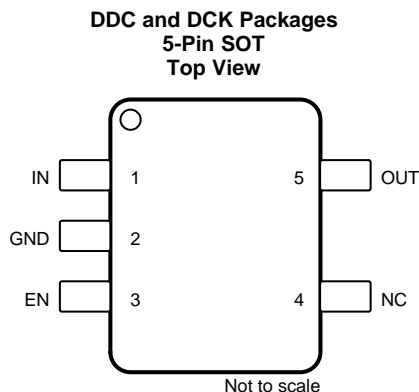

Pin Functions

PIN			I/O	DESCRIPTION
NAM E	SC70	SOT		
EN	3	3	I	Enable pin. Driving EN over 0.9 V turns on the regulator. Driving EN below 0.4 V puts the regulator into shutdown mode and reduces operating current to 1 μ A, nominal.
GND	2	2	—	Ground pin
IN	1	1	I	Input pin. A small 1- μ F ceramic capacitor is recommended from this pin to ground to assure stability and good transient performance. See Input and Output Capacitor Requirements in the Application and Implementation section for more details.
NC	4	4	—	No connection. This pin can be tied to ground to improve thermal dissipation.
OUT	5	5	O	Regulated output voltage pin. A small 1- μ F ceramic capacitor is needed from this pin to ground to assure stability. See Input and Output Capacitor Requirements in the Application and Implementation section for more details.

6 Specifications

6.1 Absolute Maximum Ratings

at $T_A = -40^\circ\text{C}$ to $+125^\circ\text{C}$ (unless otherwise noted); all voltages are with respect to GND⁽¹⁾

		MIN	MAX	UNIT
V_{IN}	Input voltage	-0.3	6	V
V_{EN}	Enable voltage	-0.3	$V_{IN} + 0.3$	V
V_{OUT}	Output voltage	-0.3	6	V
I_{OUT}	Maximum output current	Internally limited		
	Output short-circuit duration	Indefinite		
T_A	Operating ambient temperature	-40	150	$^\circ\text{C}$
T_J	Operating junction temperature	-40	150	$^\circ\text{C}$
T_{stg}	Storage temperature	-55	150	$^\circ\text{C}$

- (1) Stresses beyond those listed under *Absolute Maximum Ratings* may cause permanent damage to the device. These are stress ratings only, which do not imply functional operation of the device at these or any other conditions beyond those indicated under *Recommended Operating Conditions*. Exposure to absolute-maximum-rated conditions for extended periods may affect device reliability.

6.2 ESD Ratings

		VALUE	UNIT
$V_{(ESD)}$	Electrostatic discharge	Human-body model (HBM), per AEC Q100-002 ⁽¹⁾	± 2000
		Charged-device model (CDM), per AEC Q100-011	± 750

- (1) AEC Q100-002 indicates that HBM stressing shall be in accordance with the ANSI/ESDA/JEDEC JS-001 specification.

6.3 Recommended Operating Conditions

over operating free-air temperature range (unless otherwise noted)

		MIN	NOM	MAX	UNIT
V_{IN}	Input voltage	2		5.5	V
V_{EN}	Enable voltage	0		5.5	V
I_{OUT}	Output current		200		mA
C_{IN}	Input capacitor	0	1		μ F
C_{OUT}	Output capacitor	0.22	1		μ F
T_A	Operating ambient temperature	-40		125	$^{\circ}$ C

6.4 Thermal Information

THERMAL METRIC ⁽¹⁾	TLV700xx-Q1		UNIT
	DDC (SOT)		
	5 PINS		
$R_{\theta JA}$	Junction-to-ambient thermal resistance	262.8	$^{\circ}$ C/W
$R_{\theta JC(top)}$	Junction-to-case (top) thermal resistance	68.2	$^{\circ}$ C/W
$R_{\theta JB}$	Junction-to-board thermal resistance	81.6	$^{\circ}$ C/W
Ψ_{JT}	Junction-to-top characterization parameter	1.1	$^{\circ}$ C/W
Ψ_{JB}	Junction-to-board characterization parameter	80.9	$^{\circ}$ C/W
$R_{\theta JC(bot)}$	Junction-to-case (bottom) thermal resistance	n/a	$^{\circ}$ C/W

- (1) For more information about traditional and new thermal metrics, see the [Semiconductor and IC Package Thermal Metrics](#) application report.

6.5 Electrical Characteristics

at $T_A = -40^\circ\text{C}$ to $+125^\circ\text{C}$, $V_{IN} = V_{OUT(TYP)} + 0.3\text{ V}$ or 2 V (whichever is greater), $I_{OUT} = 10\text{ mA}$, $V_{EN} = V_{IN}$, and $C_{OUT} = 1\text{ }\mu\text{F}$ (unless otherwise noted); typical values are at $T_A = 25^\circ\text{C}$

PARAMETER		TEST CONDITIONS	MIN	TYP	MAX	UNIT
V_{IN}	Input voltage range		2		5.5	V
V_{OUT}	DC output accuracy	$-40^\circ\text{C} \leq T_A \leq +125^\circ\text{C}$, $V_{OUT} \geq 1\text{ V}$	-2%		2%	
$\Delta V_O/\Delta V_{IN}$	Line regulation	$V_{OUT(NOM)} + 0.5\text{ V} \leq V_{IN} \leq 5.5\text{ V}$, $I_{OUT} = 10\text{ mA}$		1	5	mV
$\Delta V_O/\Delta I_{OUT}$	Load regulation	$0\text{ mA} \leq I_{OUT} \leq 200\text{ mA}$			15	mV
V_{DO}	Dropout voltage ⁽¹⁾	$V_{IN} = 0.98 \times V_{OUT(NOM)}$, $I_{OUT} = 200\text{ mA}$		175	250	mV
I_{CL}	Output current limit	$V_{OUT} = 0.9 \times V_{OUT(NOM)}$	220	350	860	mA
I_{GND}	Ground pin current	$I_{OUT} = 0\text{ mA}$		31	55	μA
		$I_{OUT} = 200\text{ mA}$, $V_{IN} = V_{OUT} + 0.5\text{ V}$		270		
I_{SHDN}	Ground pin current (shutdown)	$V_{EN} \leq 0.4\text{ V}$, $2.0\text{ V} \leq V_{IN} \leq 4.5\text{ V}$		1	2.5	μA
PSRR	Power-supply rejection ratio	$V_{IN} = 2.3\text{ V}$, $V_{OUT} = 1.8\text{ V}$, $I_{OUT} = 10\text{ mA}$, $f = 1\text{ kHz}$		68		dB
V_N	Output noise voltage	BW = 100 Hz to 100 kHz, $V_{IN} = 2.3\text{ V}$, $V_{OUT} = 1.8\text{ V}$, $I_{OUT} = 10\text{ mA}$		48		μV_{RMS}
t_{STR}	Startup time ⁽²⁾	$C_{OUT} = 1\text{ }\mu\text{F}$, $I_{OUT} = 200\text{ mA}$		100		μs
$V_{EN(HI)}$	Enable pin high (enabled)		0.9		V_{IN}	V
$V_{EN(LO)}$	Enable pin low (disabled)		0		0.4	V
I_{EN}	Enable pin current	$V_{EN} = 5.5\text{ V}$, $I_{OUT} = 10\text{ }\mu\text{A}$		0.04	0.5	μA
UVLO	Undervoltage lockout	V_{IN} rising		1.9		V
T_{SD}	Thermal shutdown temperature	Shutdown, temperature increasing		160		$^\circ\text{C}$
		Reset, temperature decreasing		140		
T_A	Operating ambient temperature		-40		125	$^\circ\text{C}$

(1) V_{DO} is measured for devices with $V_{OUT(NOM)} \geq 2.35\text{ V}$.

(2) Startup time = time from EN assertion to $0.98 \times V_{OUT(NOM)}$.

6.6 Typical Characteristics

at $T_J = -40^\circ\text{C}$ to $+125^\circ\text{C}$, $V_{IN} = V_{OUT(TYP)} + 0.5\text{ V}$ or 2 V (whichever is greater), $I_{OUT} = 10\text{ mA}$, $V_{EN} = V_{IN}$, $C_{IN} = 1\ \mu\text{F}$, and $C_{OUT} = 1\ \mu\text{F}$ (unless otherwise noted); typical values are at $T_J = 25^\circ\text{C}$

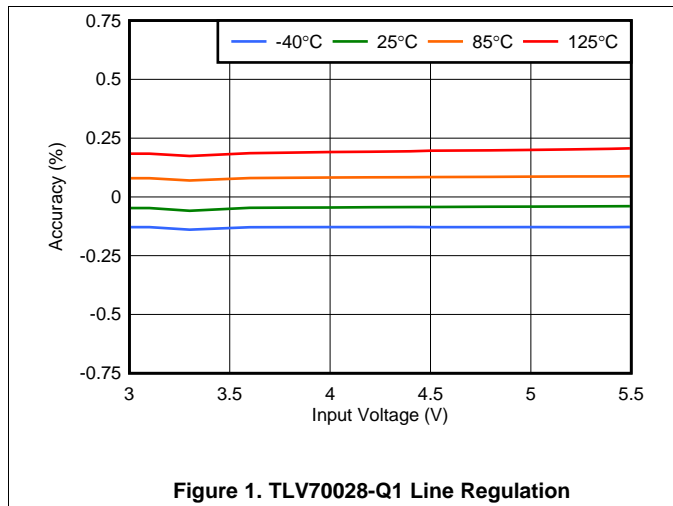

Figure 1. TLV70028-Q1 Line Regulation

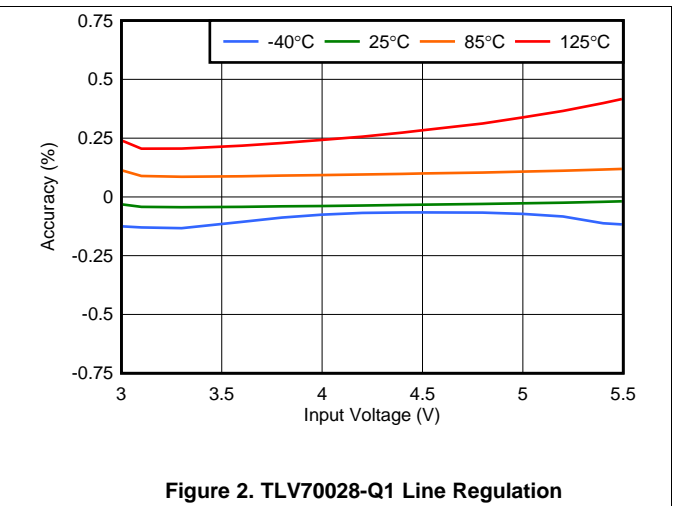

Figure 2. TLV70028-Q1 Line Regulation

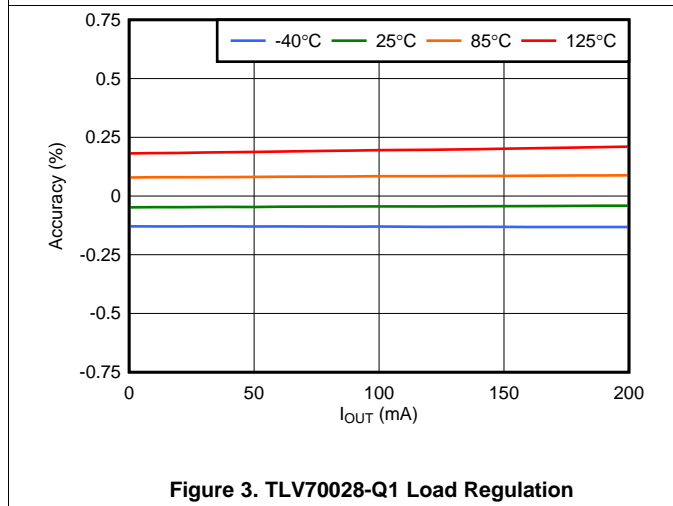

Figure 3. TLV70028-Q1 Load Regulation

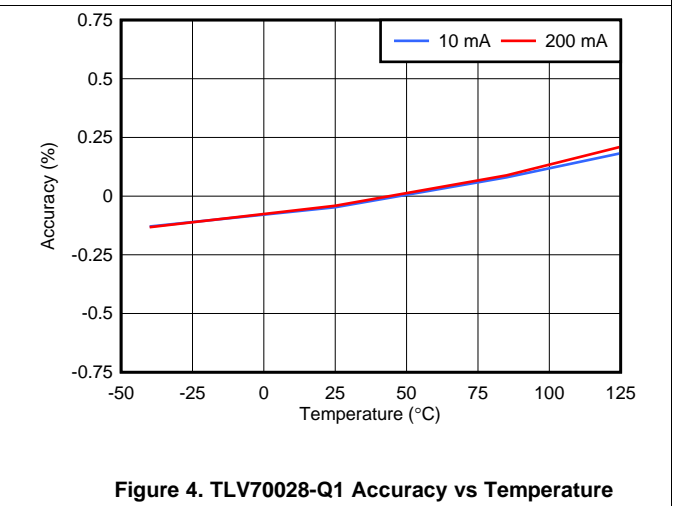

Figure 4. TLV70028-Q1 Accuracy vs Temperature

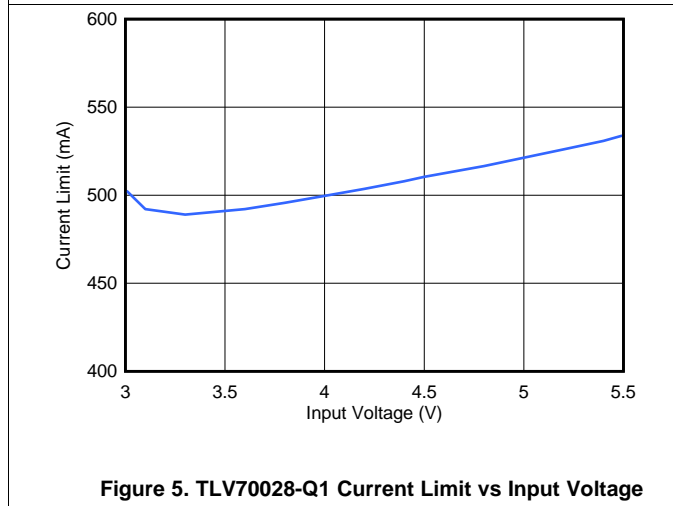

Figure 5. TLV70028-Q1 Current Limit vs Input Voltage

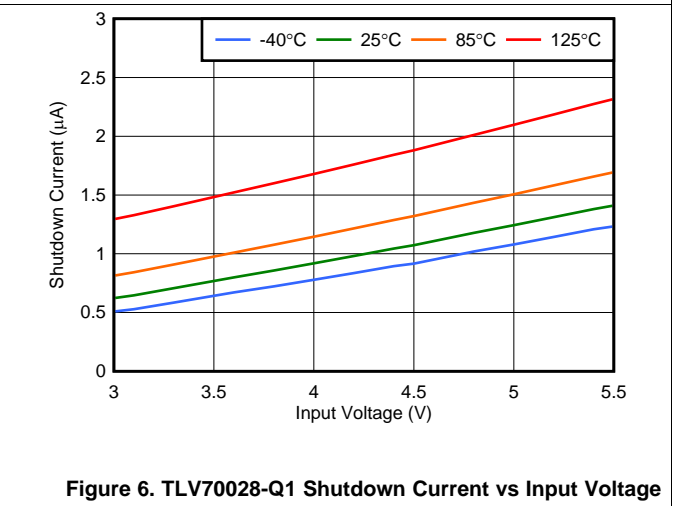

Figure 6. TLV70028-Q1 Shutdown Current vs Input Voltage

Typical Characteristics (continued)

at $T_J = -40^{\circ}\text{C}$ to $+125^{\circ}\text{C}$, $V_{IN} = V_{OUT(TYP)} + 0.5\text{ V}$ or 2 V (whichever is greater), $I_{OUT} = 10\text{ mA}$, $V_{EN} = V_{IN}$, $C_{IN} = 1\text{ }\mu\text{F}$, and $C_{OUT} = 1\text{ }\mu\text{F}$ (unless otherwise noted); typical values are at $T_J = 25^{\circ}\text{C}$

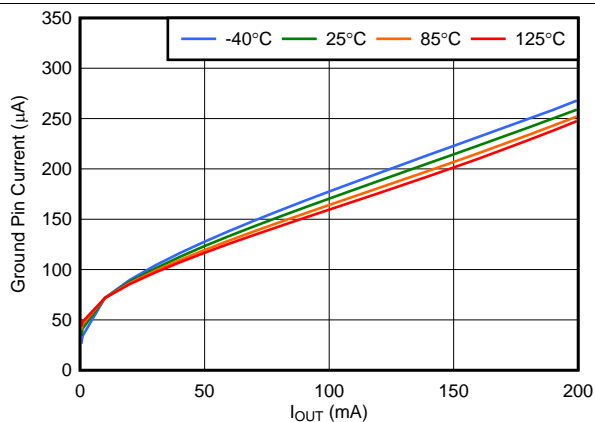

Figure 7. TLV70028-Q1 Ground Pin Current vs Output Current

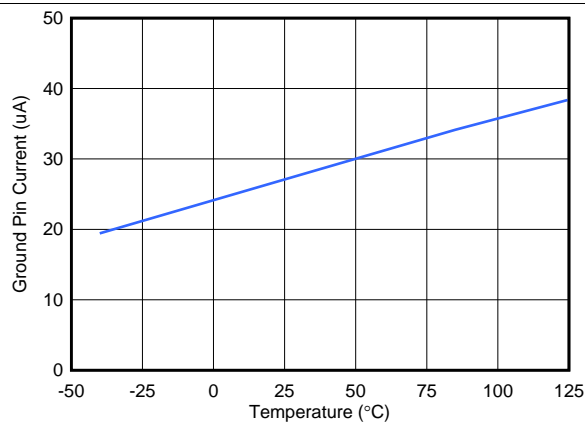

Figure 8. TLV70028-Q1 Ground Pin Current vs Temperature

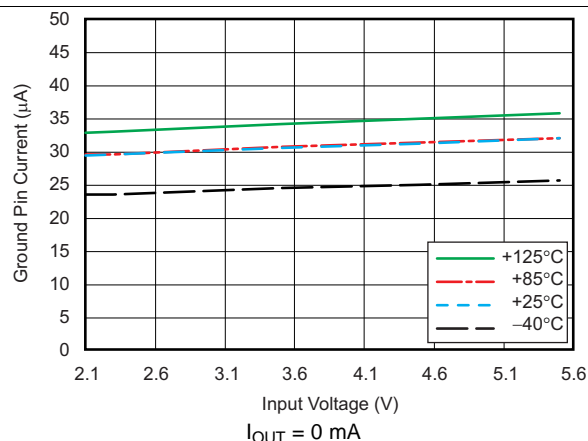

Figure 9. TLV70048-Q1 Ground Pin Current vs Input Voltage

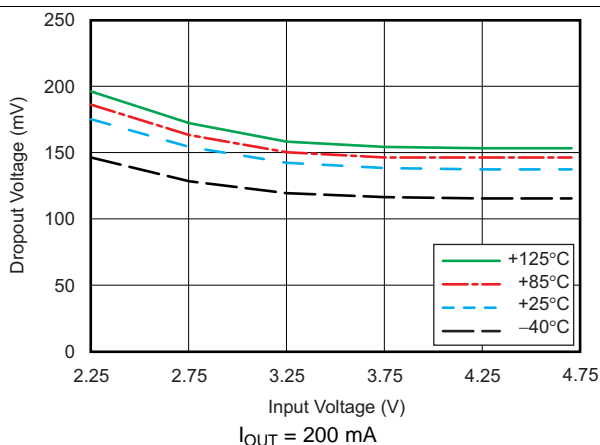

Figure 10. TLV70048-Q1 Dropout Voltage vs Input Voltage

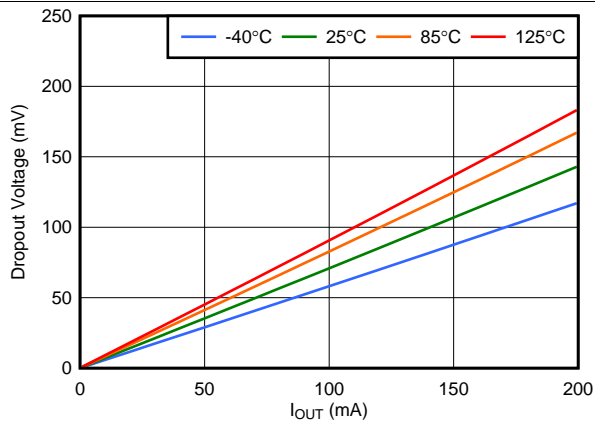

Figure 11. TLV70028-Q1 Dropout Voltage vs Output Current

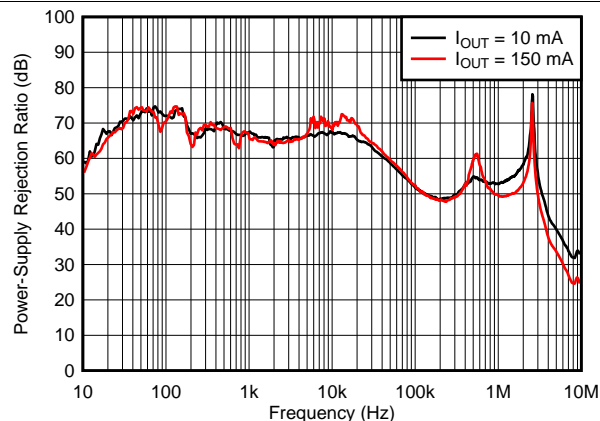

Figure 12. TLV70028-Q1 Power-Supply Rejection Ratio vs Frequency

Typical Characteristics (continued)

at $T_J = -40^{\circ}\text{C}$ to $+125^{\circ}\text{C}$, $V_{IN} = V_{OUT(TYP)} + 0.5\text{ V}$ or 2 V (whichever is greater), $I_{OUT} = 10\text{ mA}$, $V_{EN} = V_{IN}$, $C_{IN} = 1\text{ }\mu\text{F}$, and $C_{OUT} = 1\text{ }\mu\text{F}$ (unless otherwise noted); typical values are at $T_J = 25^{\circ}\text{C}$

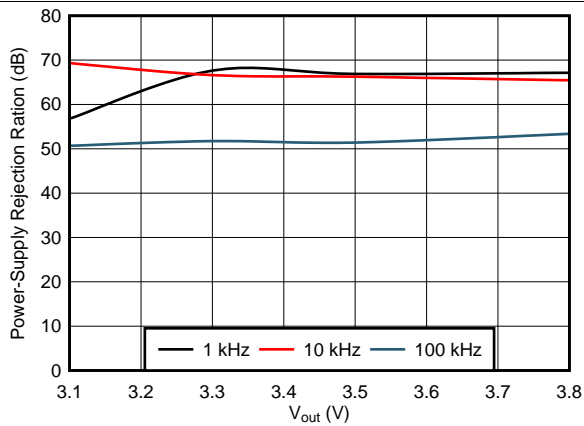

Figure 13. TLV70028-Q1 Power-Supply Rejection Ratio vs Output Voltage

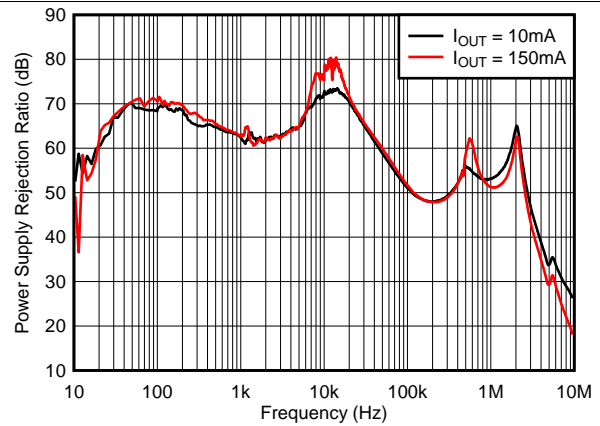

Figure 14. TLV70033-Q1 PSRR Ratio

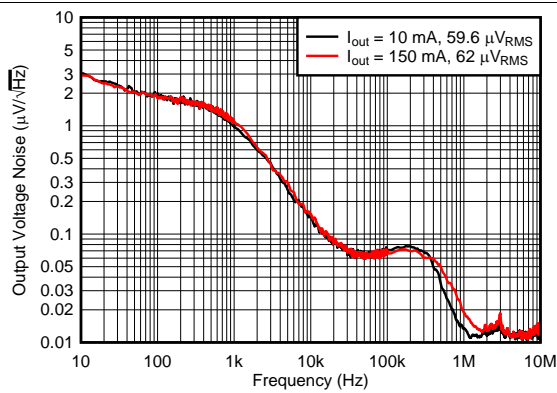

Figure 15. TLV70028-Q1 Output Spectral Noise Density vs Frequency

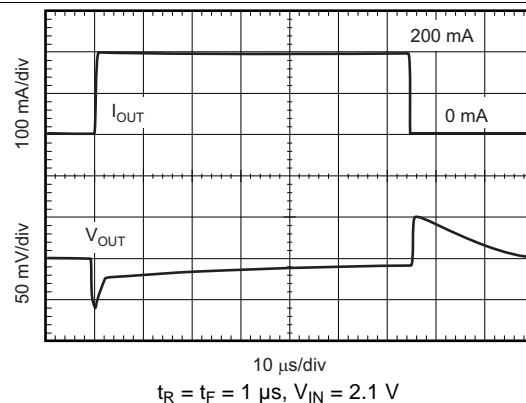

Figure 16. Load Transient Response

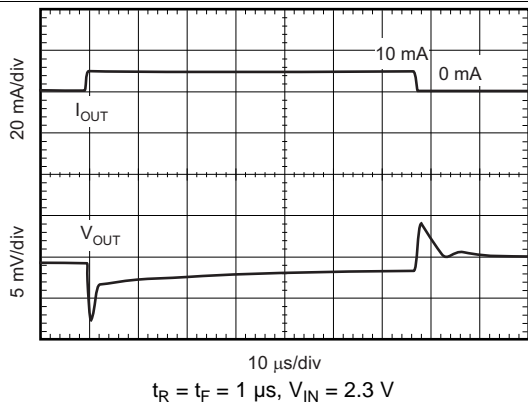

Figure 17. Load Transient Response

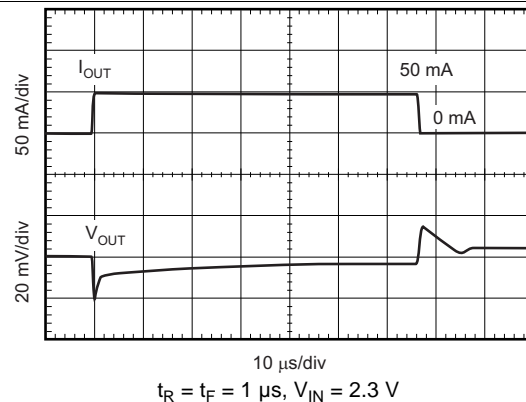
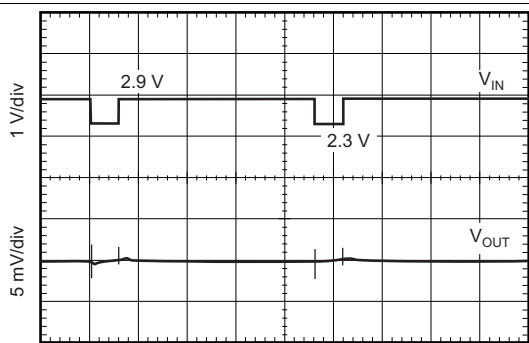

Figure 18. Load Transient Response

Typical Characteristics (continued)

at $T_J = -40^{\circ}\text{C}$ to $+125^{\circ}\text{C}$, $V_{IN} = V_{OUT(TYP)} + 0.5\text{ V}$ or 2 V (whichever is greater), $I_{OUT} = 10\text{ mA}$, $V_{EN} = V_{IN}$, $C_{IN} = 1\ \mu\text{F}$, and $C_{OUT} = 1\ \mu\text{F}$ (unless otherwise noted); typical values are at $T_J = 25^{\circ}\text{C}$



1 ms/div
Slew rate = $1\text{ V}/\mu\text{s}$, $I_{OUT} = 200\text{ mA}$

Figure 19. Line Transient Response

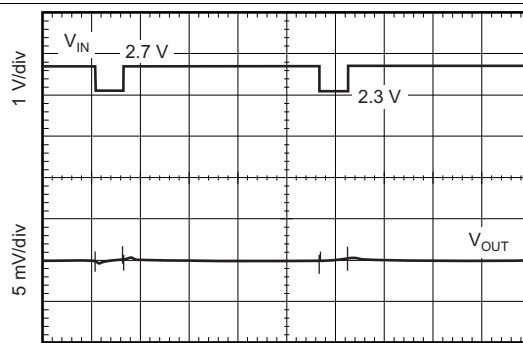

1 ms/div
Slew rate = $1\text{ V}/\mu\text{s}$, $I_{OUT} = 200\text{ mA}$

Figure 20. Line Transient Response

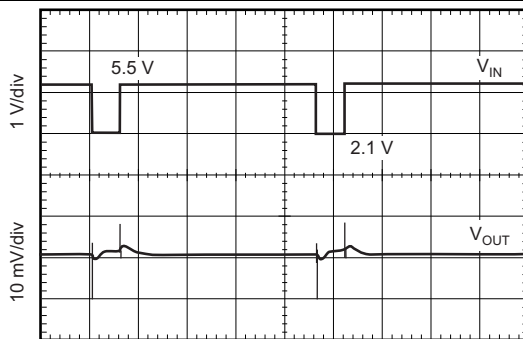

1 ms/div
Slew rate = $1\text{ V}/\mu\text{s}$, $I_{OUT} = 200\text{ mA}$

Figure 21. Line Transient Response

7 Detailed Description

7.1 Overview

The TLV700xx-Q1 low-dropout (LDO) linear regulators are low-quiescent-current devices with excellent line and load transient performance. These LDOs are designed for power-sensitive applications. A precision band-gap and error amplifier provides overall 2% accuracy together with low output noise, very high power-supply rejection ratio (PSRR), and low dropout voltage.

7.2 Functional Block Diagram

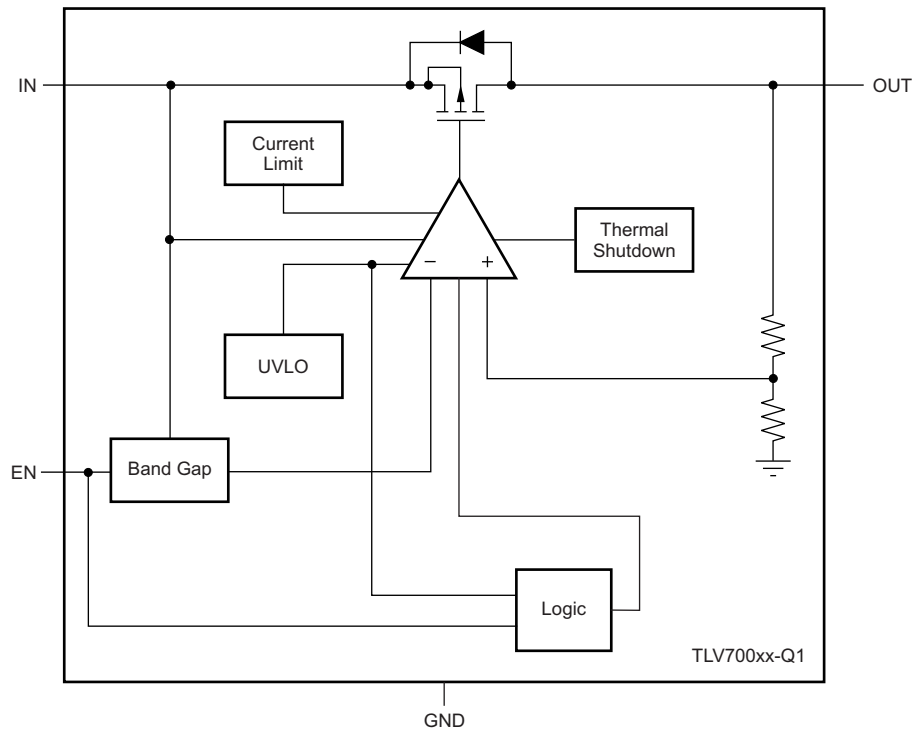

7.3 Feature Description

7.3.1 Internal Current Limit

The TLV700xx-Q1 internal current limit helps protect the regulator during fault conditions. During current limit, the output sources a fixed amount of current that is largely independent of the output voltage. In such a case, the output voltage is not regulated, and is $V_{OUT} = I_{LIMIT} \times R_{LOAD}$. The PMOS pass transistor dissipates $(V_{IN} - V_{OUT}) \times I_{LIMIT}$ until thermal shutdown is triggered and the device turns off. When the TLV700xx-Q1 cools down, the device is turned on by the internal thermal-shutdown circuit. If the fault condition continues, the device cycles between current limit and thermal shutdown; see the [Thermal Protection](#) section for more details.

The PMOS pass element in the TLV700xx-Q1 has a built-in body diode that conducts current when the voltage at OUT exceeds the voltage at IN. This current is not limited, so if extended reverse voltage operation is anticipated, external limiting to 5% of the rated output current is recommended.

7.3.2 Shutdown

The enable pin (EN) is active high and is compatible with standard and low-voltage transistor-transistor logic, complementary metal oxide semiconductor (TTL-CMOS) levels. When shutdown capability is not required, EN can be connected to the IN pin.

Feature Description (continued)

7.3.3 Dropout Voltage

The TLV700xx-Q1 uses a PMOS pass transistor to achieve low dropout. When $(V_{IN} - V_{OUT})$ is less than the dropout voltage (V_{DO}), the PMOS pass device is in the linear region of operation and the input-to-output resistance is the $r_{DS(on)}$ of the PMOS pass element. V_{DO} scales approximately with output current because the PMOS device behaves as a resistor in dropout.

As with any linear regulator, PSRR and transient response are degraded when $(V_{IN} - V_{OUT})$ approaches dropout. This effect is illustrated in [Figure 13](#) in the [Typical Characteristics](#) section.

7.3.4 Undervoltage Lockout (UVLO)

The TLV700xx-Q1 uses an undervoltage lockout circuit to keep the output shut off until the internal circuitry is operating properly.

7.4 Device Functional Modes

7.4.1 Operation with V_{IN} Less Than 2 V

The TLV700xx-Q1 family of devices operates with input voltages above 2 V. The typical UVLO voltage is 1.9 V and the device operates at an input voltage above 2 V. When the input voltage falls below the UVLO voltage, the device is shutdown.

7.4.2 Operation with V_{IN} Greater Than 2 V

When V_{IN} is greater than 2 V, if the input voltage is higher than the desired output voltage plus dropout voltage, the output voltage is equal to the desired value. Otherwise, the output voltage is V_{IN} minus the dropout voltage.

8 Application and Implementation

NOTE

Information in the following applications sections is not part of the TI component specification, and TI does not warrant its accuracy or completeness. TI's customers are responsible for determining suitability of components for their purposes. Customers should validate and test their design implementation to confirm system functionality.

8.1 Application Information

The TLV700xx-Q1 devices belong to a family of next-generation-value LDO regulators. The devices consume low quiescent current and deliver excellent line and load transient performance. These characteristics, combined with low noise and very good PSRR with little ($V_{IN} - V_{OUT}$) headroom, make this device family ideal for RF portable applications. This family of regulators offers sub-band-gap output voltages down to 0.7 V, current limit, and thermal protection, and is specified from -40°C to $+125^{\circ}\text{C}$.

8.1.1 Input and Output Capacitor Requirements

Ceramic, 1.0- μF , X5R- and X7R-type capacitors are recommended because these capacitors have minimal variation in value and equivalent series resistance (ESR) over temperature.

However, the TLV700xx-Q1 devices are designed to be stable with an effective capacitance of 0.1 μF or larger at the output. Thus, these devices are stable with capacitors of other dielectric types as well, as long as the effective capacitance under operating bias voltage and temperature is greater than 0.1 μF . This effective capacitance refers to the capacitance under the operating bias voltage and temperature conditions; that is, the capacitance after taking both bias voltage and temperature derating into consideration. In addition to allowing the use of cheaper dielectrics, this capability of being stable with 0.1- μF effective capacitances also enables the use of smaller-footprint capacitors that have higher derating in size- and space-constrained applications.

Note that using a 0.1- μF rated capacitor at the output of the LDO does not ensure stability because the effective capacitance under the specified operating conditions is less than 0.1 μF . Maximum ESR must be less than 200 m Ω .

Although an input capacitor is not required for stability, good analog design practice is to connect a 0.1- μF to 1- μF , low-ESR capacitor across the IN pin and the GND pin of the regulator. This capacitor counteracts reactive input sources and improves transient response, noise rejection, and ripple rejection. A higher-value capacitor may be necessary if large, fast, rise-time load transients are anticipated, or if the device is not located close to the power source. If source impedance is more than 2 Ω , a 0.1- μF input capacitor may be necessary to ensure stability.

8.1.2 Transient Response

As with any regulator, increasing the size of the output capacitor reduces over- and undershoot magnitude but increases the duration of the transient response.

8.1.3 Thermal Protection

Thermal protection disables the output when the junction temperature rises to approximately 160°C , allowing the device to cool. When the junction temperature cools to approximately 140°C , the output circuitry is again enabled. Depending on power dissipation, thermal resistance, and ambient temperature, the thermal protection circuit can cycle on and off. This cycling limits the dissipation of the regulator, protecting the regulator from damage as a result of overheating.

Any tendency to activate the thermal protection circuit indicates excessive power dissipation or an inadequate heatsink. For reliable operation, limit junction temperature to 125°C (maximum). To estimate the margin of safety in a complete design (including heatsink), increase the ambient temperature until the thermal protection is triggered; use worst-case loads and signal conditions. For good reliability, thermal protection must trigger at least 35°C above the maximum expected ambient condition of the particular application. This configuration produces a worst-case junction temperature of 125°C at the highest-expected ambient temperature and worst-case load.

Application Information (continued)

The internal protection circuitry of the TLV700xx-Q1 is designed to protect against overload conditions. This circuitry is not intended to replace proper heatsinking. Continuously running the TLV700xx-Q1 into thermal shutdown degrades device reliability.

8.2 Typical Application

The TLV700xx-Q1 devices are 200-mA, low quiescent current, low-noise, high-PSRR, fast start-up LDO linear regulators with excellent line and load transient response. The [TLV700xxEVM-503 user's guide](#) (SLUU391) evaluation module (EVM) helps designers evaluate the operation and performance of the TLV700xx-Q1 family.

Figure 22 shows a typical application for the TLV700xx-Q1 device.

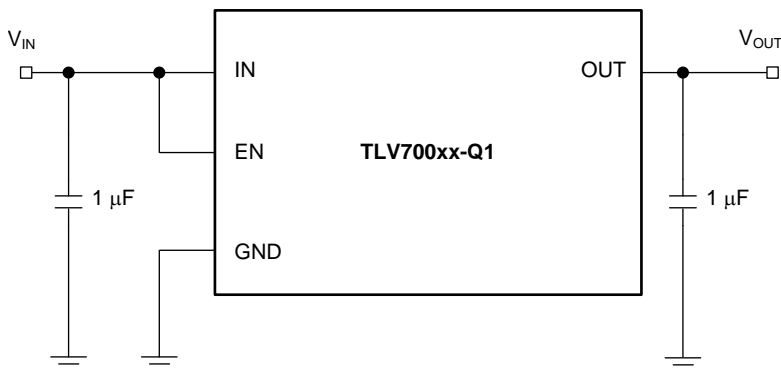

Figure 22. TLV700xx-Q1 Typical Application

8.2.1 Design Requirements

Table 1 shows example design parameters and values for this typical application.

Table 1. Design Parameters

PARAMETER	VALUE
Input voltage range	2 V to 5.5 V
Output voltage	2.2 V, 2.8 V, 3.2 V
Output current rating	200 mA
Effective output capacitor range	> 0.1 µF
Maximum output capacitor ESR range	< 200 mΩ

8.2.2 Detailed Design Procedure

8.2.2.1 Input Capacitance

Although not required for stability, connecting a 0.1-µF to 1-µF low-ESR capacitor across the IN pin and GND pin the regulator is good analog design practice.

8.2.2.2 Output Capacitance

Effect capacitance of 0.1 µF or larger is required to ensure stable operation. The maximum ESR must be less than 200 mΩ.

8.2.2.3 Thermal Calculation

Equation 1 shows the thermal calculation.

$$P_D = I_{OUT} \times (V_{IN} - V_{OUT}) + I_Q \times V_{IN}$$

where

- P_D = continuous power dissipation
 - I_{OUT} = output current
 - V_{IN} = input voltage
 - V_{OUT} = output voltage
 - Because $I_Q \ll I_{OUT}$, the term $I_Q \times V_{IN}$ is always ignored
- (1)

For a device under operation at a given ambient air temperature (T_A), use Equation 2 to calculate the junction temperature (T_J).

$$T_J = T_A + (R_{\theta JA} \times P_D)$$

where

- $Z_{\theta JA}$ = junction-to-ambient air thermal impedance
- (2)

Use Equation 3 to calculate the rise in junction temperature because of power dissipation.

$$\Delta T = T_J - T_A = (R_{\theta JA} \times P_D)$$
(3)

For a given maximum junction temperature (T_{Jmax}), use Equation 4 to calculate the maximum ambient air temperature (T_{Amax}) at which the device can operate.

$$T_{Amax} = T_{Jmax} - (R_{\theta JA} \times P_D)$$
(4)

8.2.3 Application Curve

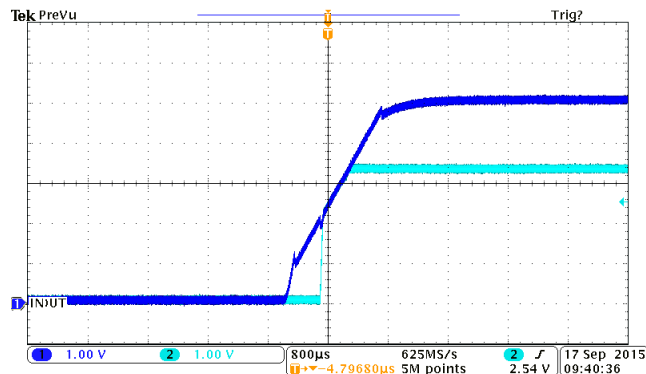

Figure 23. Power-Up

9 Power Supply Recommendations

The device is designed to operate from an input-voltage supply range between 2 V and 5.5 V. This input supply must be well regulated. If the input supply is located more than a few inches from the TPS7B69xx-Q1 device, a capacitor with a value of 0.1 μF and a ceramic bypass capacitor are recommended to be added at the input.

10 Layout

10.1 Layout Guidelines

When laying out the board for the TLV700xx-Q1, the board is recommended to be designed with separate ground planes for V_{IN} and V_{OUT} that are only connected at the GND pin of the device, as shown in [Figure 24](#). Also, the ground connection for the bypass capacitor must be connected directly to the GND pin of the device. Improve the PSRR performance of the TLV700xx-Q1 by following these layout guidelines.

10.2 Board Layout Recommendations to Improve PSRR and Noise Performance

Place input and output capacitors as close to the device pins as possible. To improve ac performance (such as PSRR, output noise, and transient response), the board is recommended to be designed with separate ground planes for V_{IN} and V_{OUT} , with the ground plane connected only at the GND pin of the device. In addition, connect the ground connection for the output capacitor directly to the GND pin of the device. High-ESR capacitors can degrade PSRR performance.

10.3 Layout Example

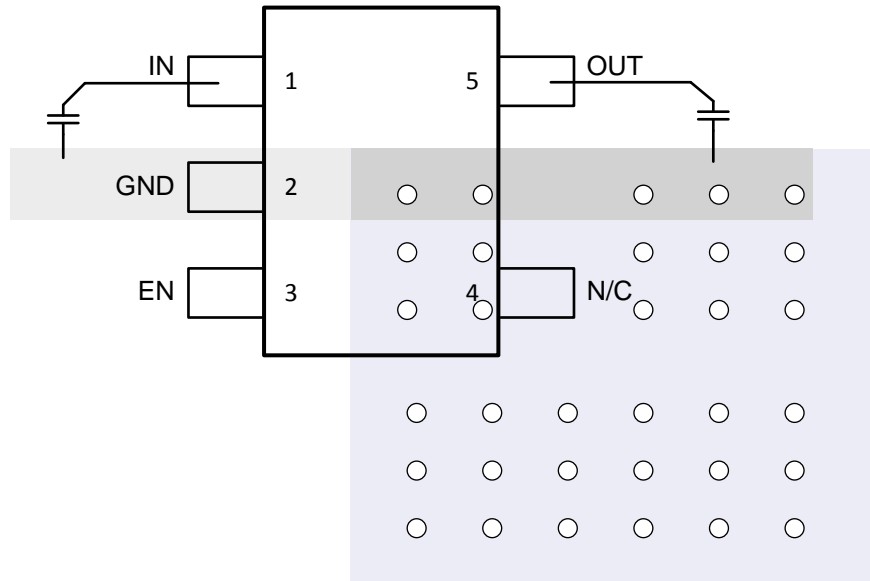

Figure 24. TLV700xx-Q1 Layout Example

11 器件和文档支持

11.1 文档支持

11.1.1 相关文档

请参阅如下相关文档：

[《使用 TLV700xxEVM-503》](#)

11.2 接收文档更新通知

要接收文档更新通知，请转至 TI.com.cn 上您的器件的产品文件夹。请在右上角单击 [通知我](#) 按钮进行注册，即可收到产品信息更改每周摘要（如有）。有关更改的详细信息，请查看任意已修订文档的修订历史记录。

11.3 社区资源

下列链接提供到 TI 社区资源的连接。链接的内容由各个分销商“按照原样”提供。这些内容并不构成 TI 技术规范，并且不一定反映 TI 的观点；请参阅 TI 的 [《使用条款》](#)。

TI E2E™ 在线社区 [TI 的工程师对工程师 \(E2E\) 社区](#)。此社区的创建目的在于促进工程师之间的协作。在 e2e.ti.com 中，您可以咨询问题、分享知识、拓展思路并与同行工程师一道帮助解决问题。

设计支持 [TI 参考设计支持](#) 可帮助您快速查找有帮助的 E2E 论坛、设计支持工具以及技术支持的联系信息。

11.4 商标

E2E is a trademark of Texas Instruments.
All other trademarks are the property of their respective owners.

11.5 静电放电警告



ESD 可能会损坏该集成电路。德州仪器 (TI) 建议通过适当的预防措施处理所有集成电路。如果不遵守正确的处理措施和安装程序，可能会损坏集成电路。

ESD 的损坏小至导致微小的性能降级，大至整个器件故障。精密的集成电路可能更容易受到损坏，这是因为非常细微的参数更改都可能会导致器件与其发布的规格不相符。

11.6 术语表

[SLYZ022](#) — *TI 术语表*。

这份术语表列出并解释术语、缩写和定义。

12 机械、封装和可订购信息

以下页面包含机械、封装和可订购信息。这些信息是指定器件的最新可用数据。数据如有变更，恕不另行通知，且不会对此文档进行修订。如需获取此产品说明书的浏览器版本，请参阅左侧的导航栏。

PACKAGING INFORMATION

Orderable Device	Status (1)	Package Type	Package Drawing	Pins	Package Qty	Eco Plan (2)	Lead finish/ Ball material (6)	MSL Peak Temp (3)	Op Temp (°C)	Device Marking (4/5)	Samples
TLV70025QDDCRQ1	ACTIVE	SOT-23-THIN	DDC	5	3000	RoHS & Green	NIPDAU	Level-2-260C-1 YEAR	-40 to 125	QVC	Samples
TLV70028QDDCRQ1	ACTIVE	SOT-23-THIN	DDC	5	3000	RoHS & Green	NIPDAU	Level-2-260C-1 YEAR	-40 to 125	SJU	Samples
TLV70032QDDCRQ1	ACTIVE	SOT-23-THIN	DDC	5	3000	RoHS & Green	NIPDAU	Level-2-260C-1 YEAR	-40 to 125	SKA	Samples
TLV70033QDDCRQ1	ACTIVE	SOT-23-THIN	DDC	5	3000	RoHS & Green	NIPDAU	Level-2-260C-1 YEAR	-40 to 125	OFL	Samples

(1) The marketing status values are defined as follows:

ACTIVE: Product device recommended for new designs.

LIFEBUY: TI has announced that the device will be discontinued, and a lifetime-buy period is in effect.

NRND: Not recommended for new designs. Device is in production to support existing customers, but TI does not recommend using this part in a new design.

PREVIEW: Device has been announced but is not in production. Samples may or may not be available.

OBSELETE: TI has discontinued the production of the device.

(2) **RoHS:** TI defines "RoHS" to mean semiconductor products that are compliant with the current EU RoHS requirements for all 10 RoHS substances, including the requirement that RoHS substance do not exceed 0.1% by weight in homogeneous materials. Where designed to be soldered at high temperatures, "RoHS" products are suitable for use in specified lead-free processes. TI may reference these types of products as "Pb-Free".

RoHS Exempt: TI defines "RoHS Exempt" to mean products that contain lead but are compliant with EU RoHS pursuant to a specific EU RoHS exemption.

Green: TI defines "Green" to mean the content of Chlorine (Cl) and Bromine (Br) based flame retardants meet JS709B low halogen requirements of <=1000ppm threshold. Antimony trioxide based flame retardants must also meet the <=1000ppm threshold requirement.

(3) MSL, Peak Temp. - The Moisture Sensitivity Level rating according to the JEDEC industry standard classifications, and peak solder temperature.

(4) There may be additional marking, which relates to the logo, the lot trace code information, or the environmental category on the device.

(5) Multiple Device Markings will be inside parentheses. Only one Device Marking contained in parentheses and separated by a "-" will appear on a device. If a line is indented then it is a continuation of the previous line and the two combined represent the entire Device Marking for that device.

(6) Lead finish/Ball material - Orderable Devices may have multiple material finish options. Finish options are separated by a vertical ruled line. Lead finish/Ball material values may wrap to two lines if the finish value exceeds the maximum column width.

Important Information and Disclaimer:The information provided on this page represents TI's knowledge and belief as of the date that it is provided. TI bases its knowledge and belief on information provided by third parties, and makes no representation or warranty as to the accuracy of such information. Efforts are underway to better integrate information from third parties. TI has taken and

continues to take reasonable steps to provide representative and accurate information but may not have conducted destructive testing or chemical analysis on incoming materials and chemicals. TI and TI suppliers consider certain information to be proprietary, and thus CAS numbers and other limited information may not be available for release.

In no event shall TI's liability arising out of such information exceed the total purchase price of the TI part(s) at issue in this document sold by TI to Customer on an annual basis.

TAPE AND REEL INFORMATION

QUADRANT ASSIGNMENTS FOR PIN 1 ORIENTATION IN TAPE

*All dimensions are nominal

Device	Package Type	Package Drawing	Pins	SPQ	Reel Diameter (mm)	Reel Width W1 (mm)	A0 (mm)	B0 (mm)	K0 (mm)	P1 (mm)	W (mm)	Pin1 Quadrant
TLV70025QDDCRQ1	SOT-23-THIN	DDC	5	3000	179.0	8.4	3.2	3.2	1.4	4.0	8.0	Q3
TLV70028QDDCRQ1	SOT-23-THIN	DDC	5	3000	180.0	8.4	3.2	3.2	1.4	4.0	8.0	Q3
TLV70032QDDCRQ1	SOT-23-THIN	DDC	5	3000	179.0	8.4	3.2	3.2	1.4	4.0	8.0	Q3
TLV70033QDDCRQ1	SOT-23-THIN	DDC	5	3000	180.0	8.4	3.2	3.2	1.4	4.0	8.0	Q3

TAPE AND REEL BOX DIMENSIONS

*All dimensions are nominal

Device	Package Type	Package Drawing	Pins	SPQ	Length (mm)	Width (mm)	Height (mm)
TLV70025QDDCRQ1	SOT-23-THIN	DDC	5	3000	213.0	191.0	35.0
TLV70028QDDCRQ1	SOT-23-THIN	DDC	5	3000	213.0	191.0	35.0
TLV70032QDDCRQ1	SOT-23-THIN	DDC	5	3000	213.0	191.0	35.0
TLV70033QDDCRQ1	SOT-23-THIN	DDC	5	3000	213.0	191.0	35.0

重要声明和免责声明

TI“按原样”提供技术和可靠性数据（包括数据表）、设计资源（包括参考设计）、应用或其他设计建议、网络工具、安全信息和其他资源，不保证没有瑕疵且不做任何明示或暗示的担保，包括但不限于对适销性、某特定用途方面的适用性或不侵犯任何第三方知识产权的暗示担保。

这些资源可供使用 TI 产品进行设计的熟练开发人员使用。您将自行承担以下全部责任：(1) 针对您的应用选择合适的 TI 产品，(2) 设计、验证并测试您的应用，(3) 确保您的应用满足相应标准以及任何其他功能安全、信息安全、监管或其他要求。

这些资源如有变更，恕不另行通知。TI 授权您仅可将这些资源用于研发本资源所述的 TI 产品的应用。严禁对这些资源进行其他复制或展示。您无权使用任何其他 TI 知识产权或任何第三方知识产权。您应全额赔偿因在这些资源的使用中对 TI 及其代表造成的任何索赔、损害、成本、损失和债务，TI 对此概不负责。

TI 提供的产品受 [TI 的销售条款](#) 或 [ti.com](#) 上其他适用条款/TI 产品随附的其他适用条款的约束。TI 提供这些资源并不会扩展或以其他方式更改 TI 针对 TI 产品发布的适用的担保或担保免责声明。

TI 反对并拒绝您可能提出的任何其他或不同的条款。

邮寄地址：Texas Instruments, Post Office Box 655303, Dallas, Texas 75265
Copyright © 2021，德州仪器 (TI) 公司

X-ON Electronics

Largest Supplier of Electrical and Electronic Components

Click to view similar products for [LDO Voltage Regulators](#) category:

Click to view products by [Texas Instruments](#) manufacturer:

Other Similar products are found below :

[AP7363-SP-13](#) [NCV8664CST33T3G](#) [L79M05TL-E](#) [AP7362-HA-7](#) [PT7M8202B12TA5EX](#) [TCR3DF185,LM\(CT](#) [TLF4949EJ](#)
[NCP4687DH15T1G](#) [NCV8703MX30TCG](#) [LP2951CN](#) [NCV4269CPD50R2G](#) [AP7315-25W5-7](#) [NCV47411PAAJR2G](#) [AP2111H-1.2TRG1](#)
[ZLDO1117QK50TC](#) [AZ1117ID-ADJTRG1](#) [NCV4263-2CPD50R2G](#) [NCP114BMX075TCG](#) [MC33269T-3.5G](#) [TLE4471GXT](#) [AP7315-33SA-](#)
[7](#) [NCV4266-2CST33T3G](#) [NCP715SQ15T2G](#) [NCV8623MN-50R2G](#) [NCV563SQ18T1G](#) [NCV8664CDT33RKG](#) [NCV4299CD250R2G](#)
[NCP715MX30TBG](#) [NCV8702MX25TCG](#) [TLE7270-2E](#) [NCV562SQ25T1G](#) [AP2213D-3.3TRG1](#) [AP2202K-2.6TRE1](#)
[NCV8170BMX300TCG](#) [NCV8152MX300180TCG](#) [NCP700CMT45TBG](#) [AP7315-33W5-7](#) [NCP154MX180300TAG](#) [AP2113AMTR-G1](#)
[NJW4104U2-33A-TE1](#) [MP2013AGG-5-P](#) [NCV8775CDT50RKG](#) [NJM2878F3-45-TE1](#) [S-19214B00A-V5T2U7](#) [S-19214B50A-V5T2U7](#) [S-](#)
[19213B50A-V5T2U7](#) [S-19214BC0A-E8T1U7*1](#) [S-19213B00A-V5T2U7](#) [S-19213B33A-V5T2U7](#) [S-19213BC0A-V5T2U7](#)