

## 用于便携式设备的 TLV707、TLV707P 200mA 低 $I_Q$ 、低噪声、低压降稳压器

### 1 特性

- 典型精度为 0.5%
- 支持 200mA 输出
- 低  $I_Q$ : 25 $\mu$ A
- 可提供 0.85V 至 5.0V 范围内的固定输出电压组合<sup>(1)</sup>
- 高电源抑制比 (PSRR):
  - 在 100Hz 时为 70dB
  - 在 1MHz 时为 50dB
- 与 0.1 $\mu$ F<sup>(2)</sup> 高效电容一起使用时保持稳定
- 热关断及过流保护功能
- 封装: 1mm x 1mm DQN (X2SON)

(1) 如需了解所有可用电压选项, 请参阅数据表末尾的封装选项附录。

(2) 更多详细信息, 请参见 [机械](#)、[封装](#) 和 [可订购信息](#) 部分。

### 2 应用

- 智能手机和无线耳机
- 游戏和玩具
- WLAN 和其他 PC 附加卡
- 电视 (TV) 和机顶盒
- 可穿戴电子产品

### 3 说明

TLV707 系列 (TLV707 和 TLV707P) 低压降线性稳压器 (LDO) 具有较低的静态电流, 并且线路和负载瞬态性能出色, 适用于功耗敏感型应用。此系列器件可提供典型值为 0.5% 的精度。所有的版本均具有旨在实现安全性的热关断及过流保护功能。

此外, 这些器件还能在采用仅 0.1 $\mu$ F 的有效输出电容时保持稳定。这一特性允许使用具有较高偏置电压和温度降额的成本有效电容器。这些器件还在无输出负载的情况下调节至额定的准确度。

另外, TLV707P 还提供了一个有源下拉电路, 用于使输出快速放电。

TLV707 系列 LDO 采用 1mm x 1mm DQN (X2SON) 封装, 因此适用于手持类应用。

器件信息<sup>(1)</sup>

器件型号	封装	封装尺寸 (标称值)
TLV707	X2SON (4)	1.00mm x 1.00mm
TLV707P		

(1) 如需了解所有可用封装, 请参阅数据表末尾的封装选项附录。

典型应用电路

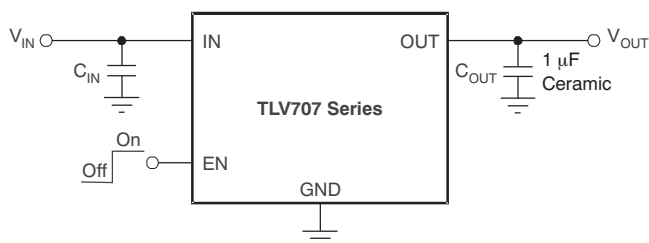

## 目录

1	特性 .....	1	8.1	Application Information.....	20
2	应用 .....	1	8.2	Typical Application .....	20
3	说明 .....	1	8.3	Do's and Don'ts.....	23
4	修订历史记录 .....	2	<b>9</b>	<b>Power Supply Recommendations .....</b>	<b>24</b>
<b>5</b>	<b>Pin Configuration and Functions .....</b>	<b>4</b>	<b>10</b>	<b>Layout.....</b>	<b>24</b>
<b>6</b>	<b>Specifications.....</b>	<b>5</b>	10.1	Layout Guidelines .....	24
6.1	Absolute Maximum Ratings .....	5	10.2	Layout Example .....	24
6.2	ESD Ratings.....	5	10.3	Thermal Considerations .....	24
6.3	Recommended Operating Conditions.....	5	10.4	Power Dissipation .....	25
6.4	Thermal Information .....	5	<b>11</b>	<b>器件和文档支持 .....</b>	<b>26</b>
6.5	Electrical Characteristics.....	6	11.1	器件支持 .....	26
6.6	Typical Characteristics .....	7	11.2	文档支持 .....	26
<b>7</b>	<b>Detailed Description .....</b>	<b>17</b>	11.3	相关链接 .....	26
7.1	Overview .....	17	11.4	接收文档更新通知 .....	26
7.2	Functional Block Diagrams .....	17	11.5	社区资源 .....	26
7.3	Feature Description.....	18	11.6	商标 .....	27
7.4	Device Functional Modes.....	19	11.7	静电放电警告 .....	27
<b>8</b>	<b>Application and Implementation .....</b>	<b>20</b>	11.8	术语表 .....	27
			<b>12</b>	<b>机械、封装和可订购信息 .....</b>	<b>27</b>

## 4 修订历史记录

注：之前版本的页码可能与当前版本有所不同。

Changes from Revision E (February 2016) to Revision F	Page
• Changed $V_{(ESD)}$ HBM value from $\pm 2000$ V to $\pm 4000$ V in <i>ESD Ratings</i> table.....	5

Changes from Revision D (January 2015) to Revision E	Page
• 将器件名改为 TLV707、TLV707P，通篇更改了 $V_{IN}$ 、 $V_{OUT(nom)}$ 、 $I_{OUT}$ 符号 .....	1
• 更改了封装特性项目符号中的 DQN 封装符号 .....	1
• 已更改应用要点 .....	1
• 已删除说明部分 .....	1
• 已更改首页图的标题 .....	1
• Changed <i>Thermal Information</i> table .....	5
• Changed $T_A$ to $T_J$ in conditions of <i>Electrical Characteristics</i> table .....	6
• Deleted temperature test conditions from $V_{OUT}$ parameter in <i>Electrical Characteristics</i> table .....	6
• Deleted UVLO parameter from <i>Electrical Characteristics</i> table .....	6
• Deleted UVLO block from <a href="#">Figure 58</a> .....	18
• Added cross-reference for <a href="#">Equation 1</a> .....	19
• Changed <i>Device Functional Modes</i> section .....	19
• Deleted <i>Undervoltage Lockout (UVLO)</i> section .....	19
• Changed title of <a href="#">Figure 59</a> .....	20
• Added cross-reference for <a href="#">Table 1</a> .....	20
• Added cross-reference for <a href="#">Figure 68</a> .....	24

<b>Changes from Revision C (November 2012) to Revision D</b>	<b>Page</b>
• 已更改 通篇将对 <i>DFN (SON)</i> 封装的引用更改为 <i>DQN (X2SON)</i> .....	1
• 已更改 更改了特性 列表项目符号 .....	1
• 已更改 更改了说明 部分 第四段 .....	1
• 已添加 增加了 <i>ESD</i> 额定值表、特性 说明 部分、器件功能模式、应用和实施部分、电源相关建议部分、布局部分、器件和文档支持部分以及机械、封装和可订购信息部分 .....	1
• Changed Pin Descriptions table contents .....	4
• Changed Overview section .....	17
• Changed Internal Current Limit section .....	18
• Changed Input and Output Capacitor Requirements section .....	20

<b>Changes from Revision B (October 2011) to Revision C</b>	<b>Page</b>
• 已更改 更改了第四个特性项目符号中的电压范围 .....	1
• 已更改 更改了首页上的引脚图 .....	1
• Changed Output voltage range parameter minimum specification in Electrical Characteristics table .....	6
• Changed DC output accuracy parameter test conditions in Electrical Characteristics table .....	6
• 已更改 “订购信息”表的脚注 2 中的电压范围 .....	26

<b>Changes from Revision A (August 2011) to Revision B</b>	<b>Page</b>
• 从特性中删除了对 <i>DCK</i> 封装的 引用 .....	1
• 删除了 <i>DCK</i> 封装引脚图 .....	1
• Deleted column for <i>DCK</i> package from Pin Descriptions table .....	4
• Deleted <i>DCK</i> package from Thermal Information table .....	5

<b>Changes from Original (February 2011) to Revision A</b>	<b>Page</b>
• 已添加 在 特性 中增加了脚注，以显示可用电压选项 .....	1
• 在 <i>DCK</i> 引脚图中增加了预览横幅 .....	1

## 5 Pin Configuration and Functions

**DQN Package  
4-Pin X2SON  
Top View**

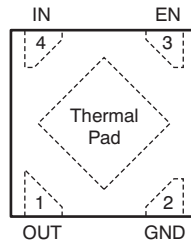

**Pin Functions**

PIN		I/O	DESCRIPTION
NAME	NO.		
EN	3	I	Enable pin. Driving EN over 0.9 V turns on the regulator. Driving EN below 0.4 V puts the regulator into shutdown mode. For TLV707P, output voltage is discharged through an internal 120-Ω resistor when device is shut down.
GND	2	—	Ground pin
IN	4	I	Input pin. For good transient performance, place a small 1-μF ceramic capacitor from this pin to ground. See <a href="#">Input and Output Capacitor Requirements</a> for more details.
OUT	1	O	Regulated output voltage pin. A small 1-μF ceramic capacitor is required from this pin to ground to assure stability. See <a href="#">Input and Output Capacitor Requirements</a> for more details.

## 6 Specifications

### 6.1 Absolute Maximum Ratings

over operating junction temperature range (unless otherwise noted)<sup>(1)</sup>

		MIN	MAX	UNIT
Voltage <sup>(2)</sup>	IN	−0.3	6.0	V
	EN	−0.3	6.0	V
	OUT	−0.3	6.0	V
Current (source)	OUT	Internally limited		
Output short-circuit duration		Indefinite		
Temperature	Operating junction, T <sub>J</sub>	−55	150	°C
	Storage, T <sub>stg</sub>	−55	150	°C

- (1) Stresses beyond those listed under *Absolute Maximum Ratings* may cause permanent damage to the device. These are stress ratings only, and functional operation of the device at these or any other conditions beyond those indicated under *Recommended Operating Conditions* is not implied. Exposure to absolute-maximum-rated conditions for extended periods may affect device reliability.
- (2) All voltages are with respect to network ground pin.

### 6.2 ESD Ratings

		VALUE	UNIT
V <sub>(ESD)</sub>	Electrostatic discharge	Human body model (HBM) QSS 009-105 (JESD22-A114A) <sup>(1)</sup>	±4000
		Charged device model (CDM) QSS 009-147 (JESD22-C101B.01) <sup>(2)</sup>	±500

- (1) JEDEC document JEP155 states that 500-V HBM allows safe manufacturing with a standard ESD control process.
- (2) JEDEC document JEP157 states that 250-V CDM allows safe manufacturing with a standard ESD control process.

### 6.3 Recommended Operating Conditions

over operating junction temperature range (unless otherwise noted)

		MIN	NOM	MAX	UNIT
V <sub>IN</sub>	Input voltage	2.0		5.5	V
I <sub>OUT</sub>	Output current	0		200	mA
T <sub>J</sub>	Operating junction temperature	−40		125	°C

### 6.4 Thermal Information

THERMAL METRIC <sup>(1)</sup>		TLV707, TLV707P	UNIT
		DQN (X2SON)	
		4 PINS	
R <sub>θJA</sub>	Junction-to-ambient thermal resistance	208.1	°C/W
R <sub>θJC(top)</sub>	Junction-to-case (top) thermal resistance	108.8	°C/W
R <sub>θJB</sub>	Junction-to-board thermal resistance	159.4	°C/W
ψ <sub>JT</sub>	Junction-to-top characterization parameter	3.8	°C/W
ψ <sub>JB</sub>	Junction-to-board characterization parameter	159.4	°C/W
R <sub>θJC(bot)</sub>	Junction-to-case (bottom) thermal resistance	110.2	°C/W

- (1) For more information about traditional and new thermal metrics, see the [Semiconductor and IC Package Thermal Metrics](#) application report.

## 6.5 Electrical Characteristics

At  $V_{IN} = V_{OUT(nom)} + 0.5\text{ V}$  or  $2.0\text{ V}$  (whichever is greater);  $I_{OUT} = 1\text{ mA}$ ,  $V_{EN} = V_{IN}$ ,  $C_{OUT} = 0.47\text{ }\mu\text{F}$ , and  $T_J = -40^\circ\text{C}$  to  $+85^\circ\text{C}$  (unless otherwise noted). Typical values are at  $T_J = 25^\circ\text{C}$ .

PARAMETER		TEST CONDITIONS		MIN	TYP	MAX	UNIT
$V_{OUT}$	Output voltage range			0.85		5	V
	DC output accuracy	$V_{OUT} \geq 0.85\text{ V}$			0.5%		
$\Delta V_{O(\Delta VI)}$	Line regulation				1	5	mV
$\Delta V_{O(\Delta IO)}$	Load regulation	$0\text{ mA} \leq I_{OUT} \leq 150\text{ mA}$			10	20	mV
$V_{(DO)}$	Dropout voltage	$V_{IN} = 0.98 \times V_{OUT(nom)}$	$2.0\text{ V} < V_{OUT} \leq 2.4\text{ V}$	$I_{OUT} = 30\text{ mA}$	65		mV
				$I_{OUT} = 150\text{ mA}$	325	360	
			$2.4\text{ V} < V_{OUT} \leq 2.8\text{ V}$	$I_{OUT} = 30\text{ mA}$	50		
				$I_{OUT} = 150\text{ mA}$	250	300	
			$2.8\text{ V} < V_{OUT} \leq 3.3\text{ V}$	$I_{OUT} = 30\text{ mA}$	45		
				$I_{OUT} = 150\text{ mA}$	220	270	
$3.3\text{ V} < V_{OUT} \leq 5.0\text{ V}$	$I_{OUT} = 30\text{ mA}$	40					
	$I_{OUT} = 150\text{ mA}$	200	250				
$I_{CL}$	Output current limit	$V_{OUT} = 0.9 \times V_{OUT(nom)}$		240	300	450	mA
$I_{(GND)}$	Ground pin current	$I_{OUT} = 0\text{ mA}$			25	50	$\mu\text{A}$
$I_{(EN)}$	EN pin current	$V_{EN} = 5.5\text{ V}$			0.01		$\mu\text{A}$
$I_{SHUTDOWN}$	Shutdown current	$V_{EN} \leq 0.4\text{ V}$ , $2.0\text{ V} \leq V_{IN} \leq 4.5\text{ V}$			1		$\mu\text{A}$
$V_{IL(EN)}$	EN pin low-level input voltage (disable device)			0		0.4	V
$V_{IH(EN)}$	EN pin high-level input voltage (enable device)			0.9		$V_{IN}$	V
PSRR	Power-supply rejection ratio	$V_{IN} = 3.3\text{ V}$ , $V_{OUT} = 2.8\text{ V}$ , $I_{OUT} = 30\text{ mA}$	$f = 100\text{ Hz}$		70		dB
			$f = 10\text{ kHz}$		55		
			$f = 1\text{ MHz}$		50		
$V_n$	Output noise voltage	BW = 100 Hz to 100 kHz, $V_{IN} = 2.3\text{ V}$ , $V_{OUT} = 1.8\text{ V}$ , $I_{OUT} = 10\text{ mA}$			45		$\mu\text{V}_{RMS}$
$t_{STR}$	Startup time <sup>(1)</sup>	$C_{OUT} = 1.0\text{ }\mu\text{F}$ , $I_{OUT} = 150\text{ mA}$			100		$\mu\text{s}$
$R_{PULLDOWN}$	Pulldown resistance (TLV707P only)				120		$\Omega$

(1) Startup time = time from EN assertion to  $0.98 \times V_{out}$ .

### 6.6 Typical Characteristics

At  $T_J = -40^\circ\text{C}$  to  $+85^\circ\text{C}$ ,  $V_{IN} = V_{OUT(nom)} + 0.5\text{ V}$  or  $2.0\text{ V}$  (whichever is greater),  $I_{OUT} = 10\text{ mA}$ ,  $V_{EN} = V_{IN}$ , and  $C_{OUT} = 1\ \mu\text{F}$ , unless otherwise noted. Typical values are at  $T_J = 25^\circ\text{C}$ .

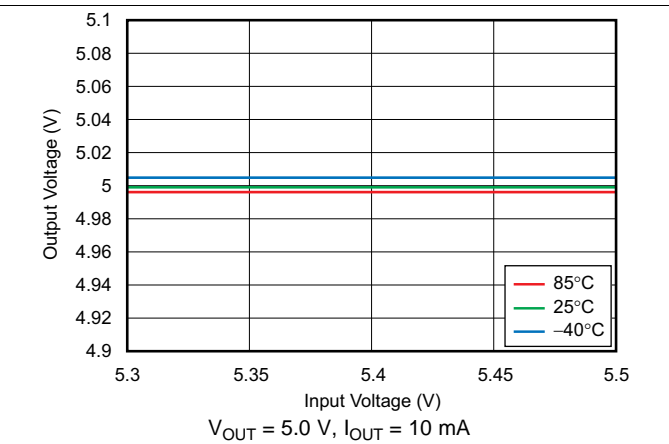
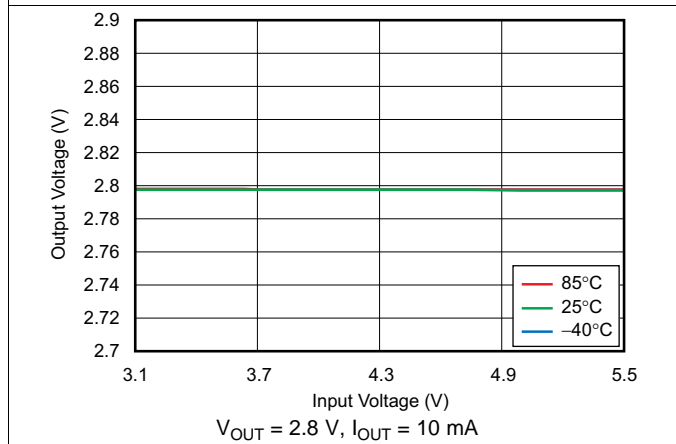
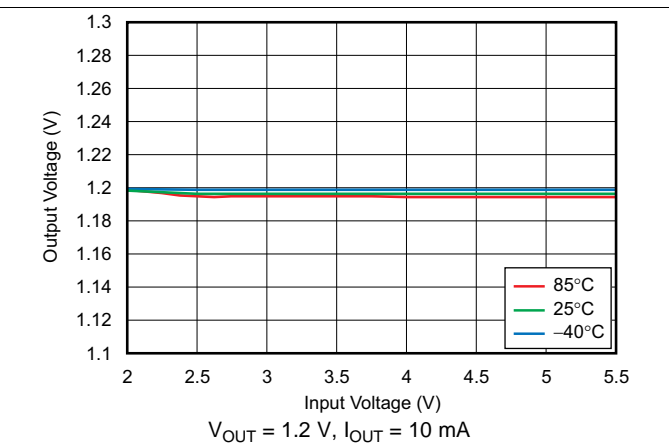
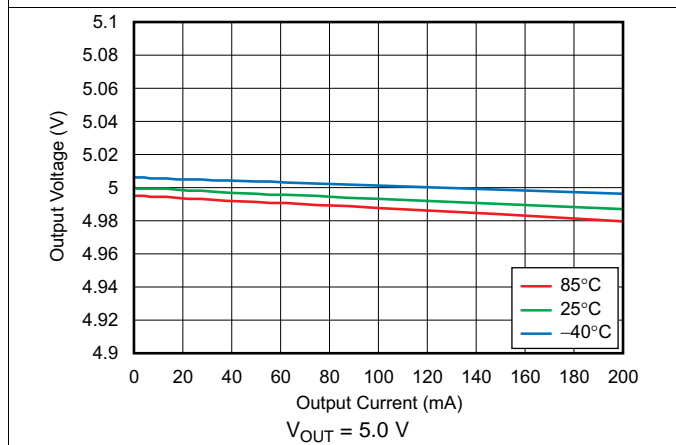
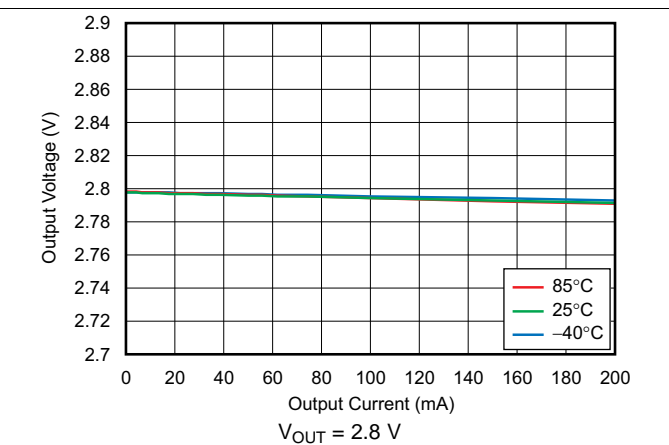
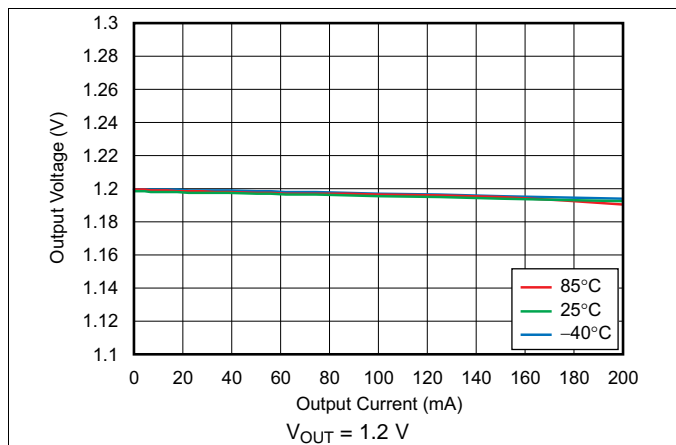

Typical Characteristics (continued)

At  $T_J = -40^\circ\text{C}$  to  $+85^\circ\text{C}$ ,  $V_{IN} = V_{OUT(nom)} + 0.5\text{ V}$  or  $2.0\text{ V}$  (whichever is greater),  $I_{OUT} = 10\text{ mA}$ ,  $V_{EN} = V_{IN}$ , and  $C_{OUT} = 1\ \mu\text{F}$ , unless otherwise noted. Typical values are at  $T_J = 25^\circ\text{C}$ .

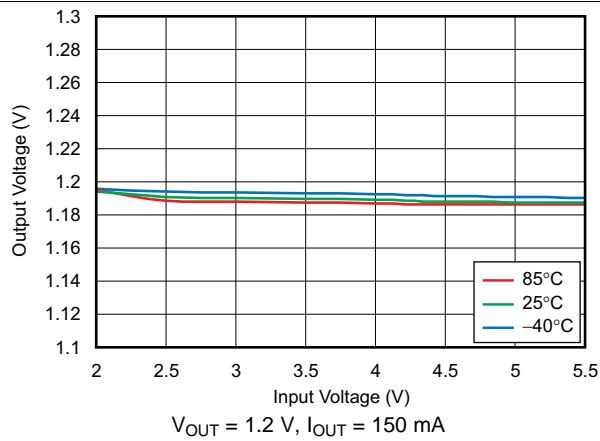

Figure 7. Line Regulation

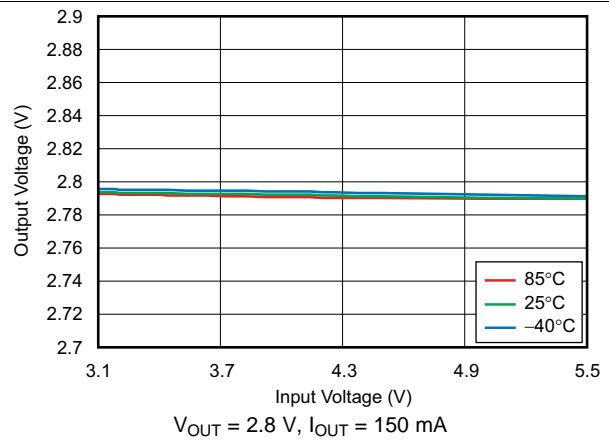

Figure 8. Line Regulation

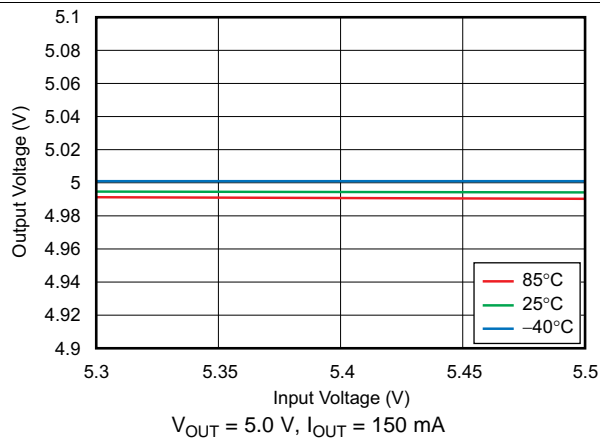

Figure 9. Line Regulation

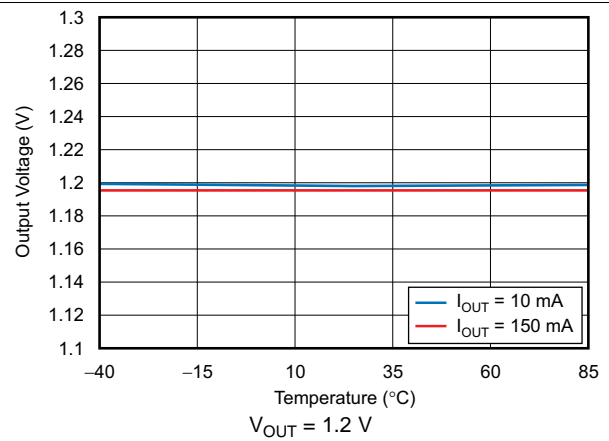

Figure 10. Output Voltage vs Temperature

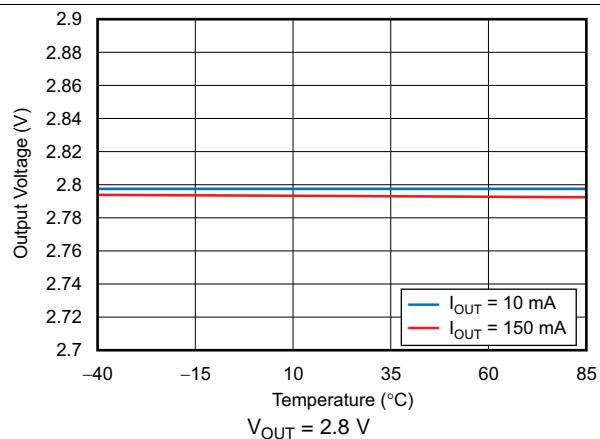

Figure 11. Output Voltage vs Temperature

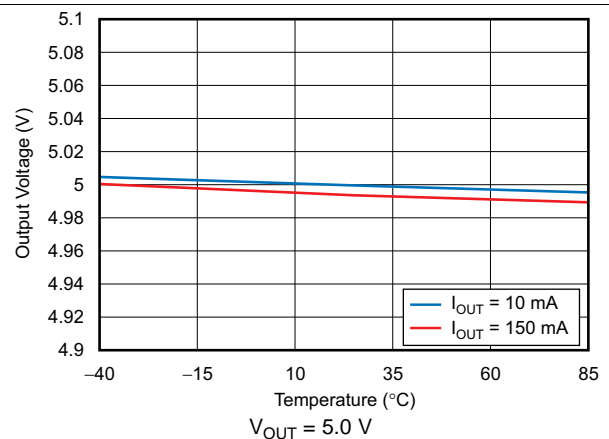

Figure 12. Output Voltage vs Temperature



Typical Characteristics (continued)

At  $T_J = -40^\circ\text{C}$  to  $+85^\circ\text{C}$ ,  $V_{IN} = V_{OUT(nom)} + 0.5\text{ V}$  or  $2.0\text{ V}$  (whichever is greater),  $I_{OUT} = 10\text{ mA}$ ,  $V_{EN} = V_{IN}$ , and  $C_{OUT} = 1\ \mu\text{F}$ , unless otherwise noted. Typical values are at  $T_J = 25^\circ\text{C}$ .

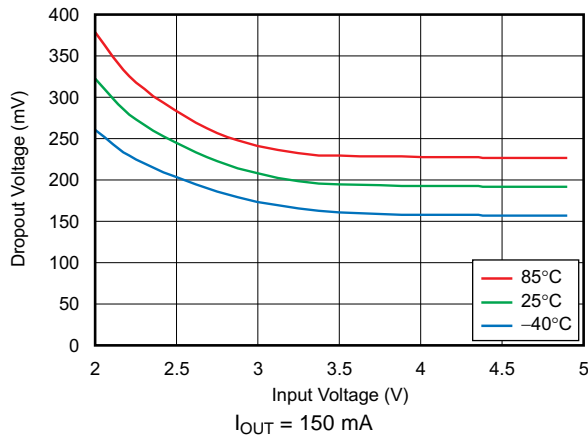

Figure 13. Dropout Voltage vs Input Voltage

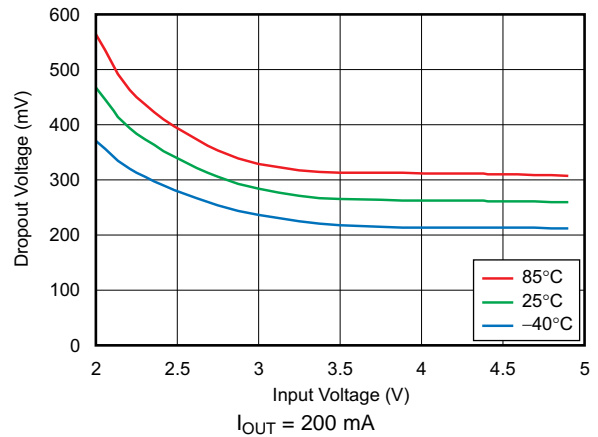

Figure 14. Dropout Voltage vs Input Voltage

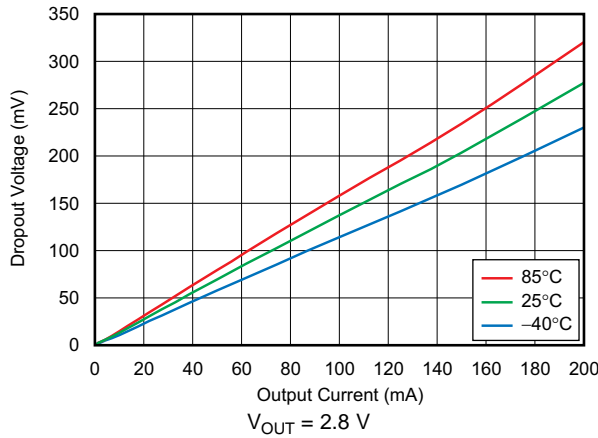

Figure 15. Dropout Voltage vs Output Current

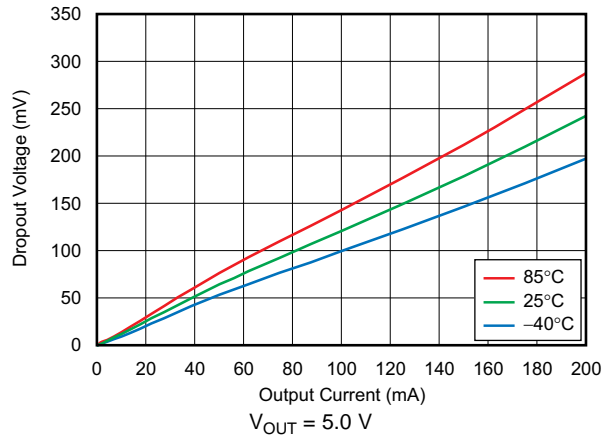

Figure 16. Dropout Voltage vs Output Current

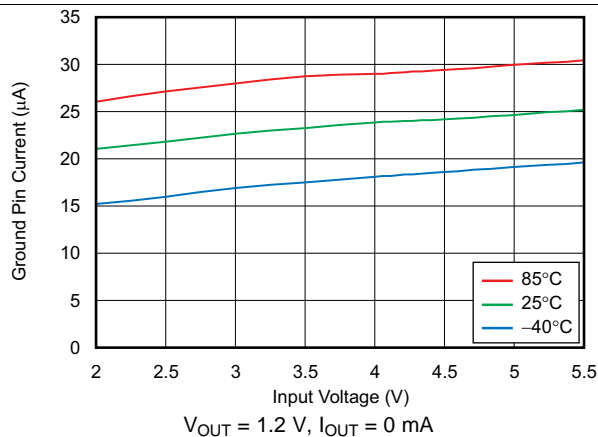

Figure 17. Ground Pin Current vs Input Voltage

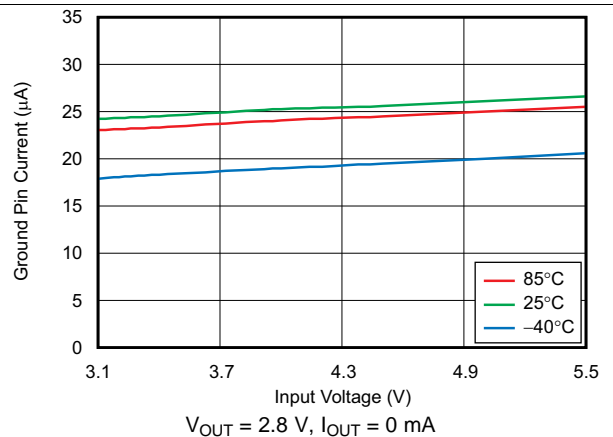

Figure 18. Ground Pin Current vs Input Voltage

### Typical Characteristics (continued)

At  $T_J = -40^\circ\text{C}$  to  $+85^\circ\text{C}$ ,  $V_{IN} = V_{OUT(nom)} + 0.5\text{ V}$  or  $2.0\text{ V}$  (whichever is greater),  $I_{OUT} = 10\text{ mA}$ ,  $V_{EN} = V_{IN}$ , and  $C_{OUT} = 1\ \mu\text{F}$ , unless otherwise noted. Typical values are at  $T_J = 25^\circ\text{C}$ .

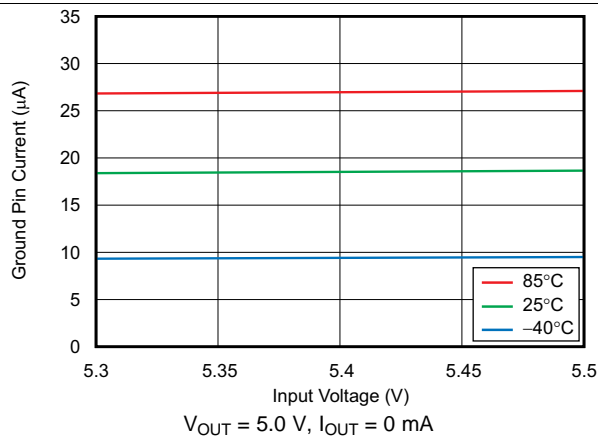

Figure 19. Ground Pin Current vs Input Voltage

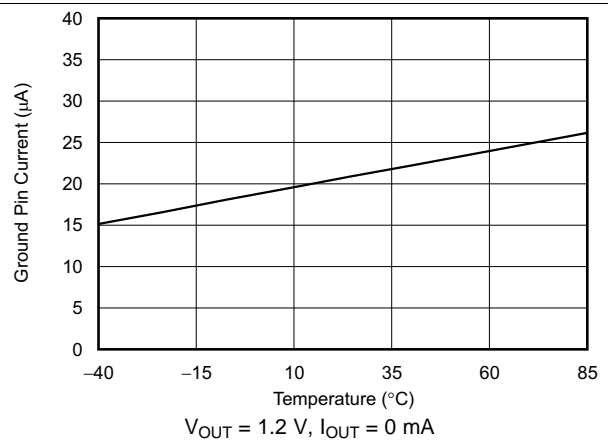

Figure 20. Ground Pin Current vs Temperature

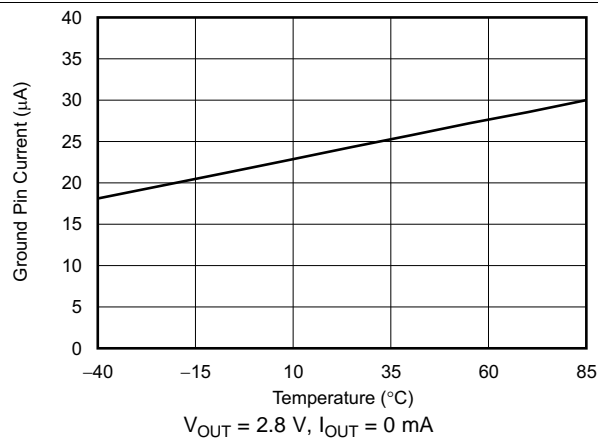

Figure 21. Ground Pin Current vs Temperature

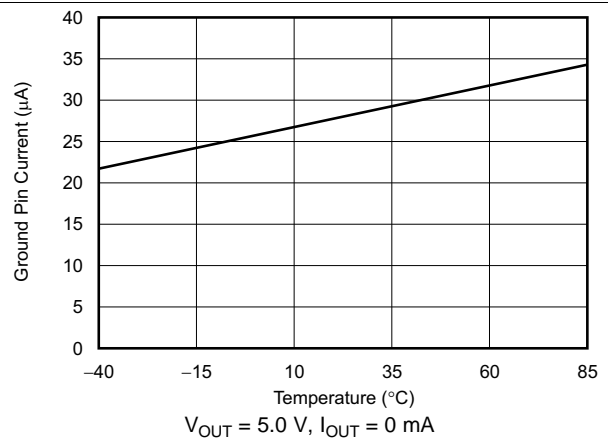

Figure 22. Ground Pin Current vs Temperature

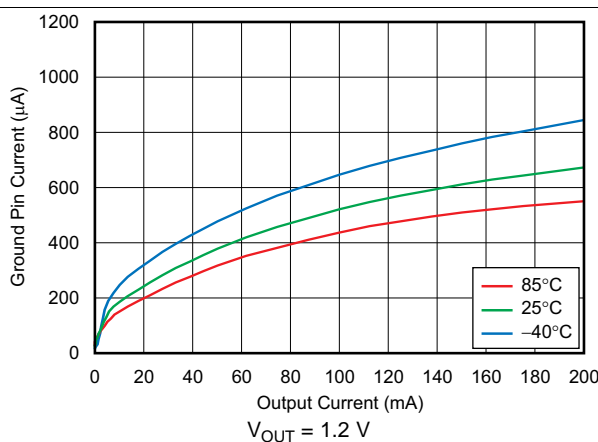

Figure 23. Ground Pin Current vs Output Current

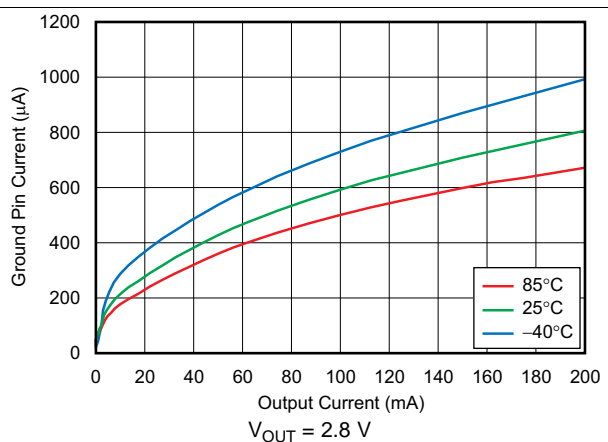

Figure 24. Ground Pin Current vs Output Current

Typical Characteristics (continued)

At  $T_J = -40^\circ\text{C}$  to  $+85^\circ\text{C}$ ,  $V_{IN} = V_{OUT(nom)} + 0.5\text{ V}$  or  $2.0\text{ V}$  (whichever is greater),  $I_{OUT} = 10\text{ mA}$ ,  $V_{EN} = V_{IN}$ , and  $C_{OUT} = 1\ \mu\text{F}$ , unless otherwise noted. Typical values are at  $T_J = 25^\circ\text{C}$ .

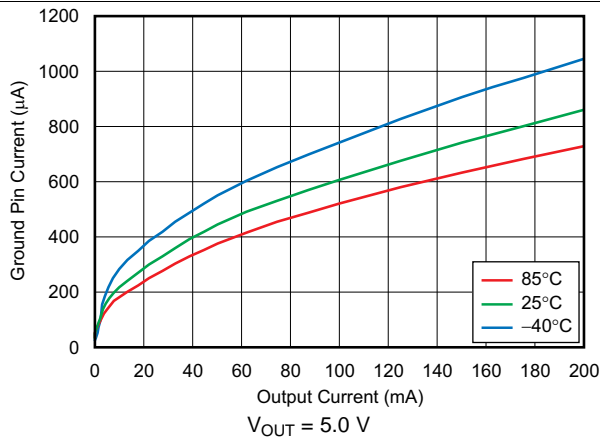

Figure 25. Ground Pin Current vs Output Current

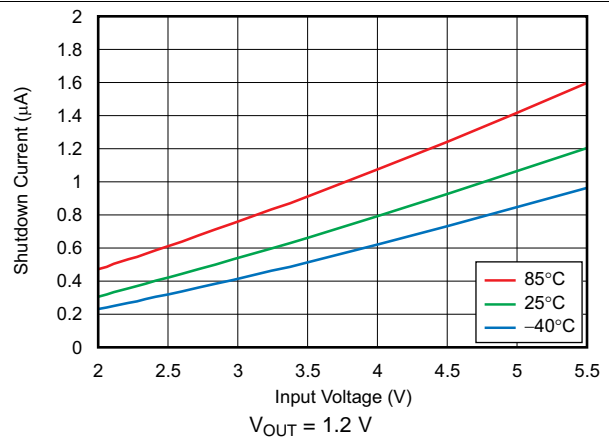

Figure 26. Shutdown Current vs Input Voltage

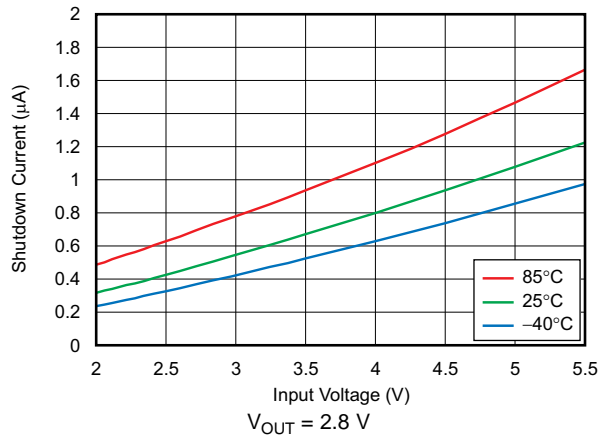

Figure 27. Shutdown Current vs Input Voltage

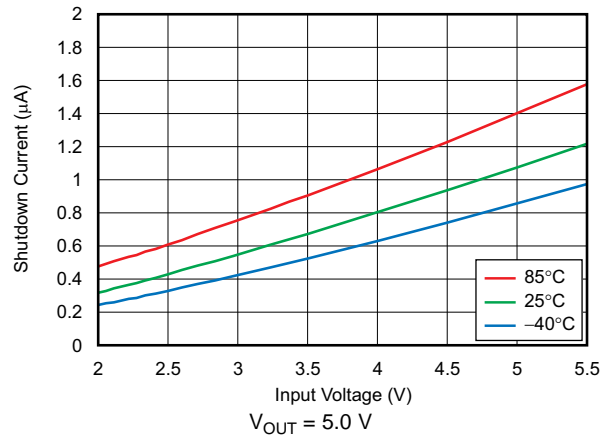

Figure 28. Shutdown Current vs Input Voltage

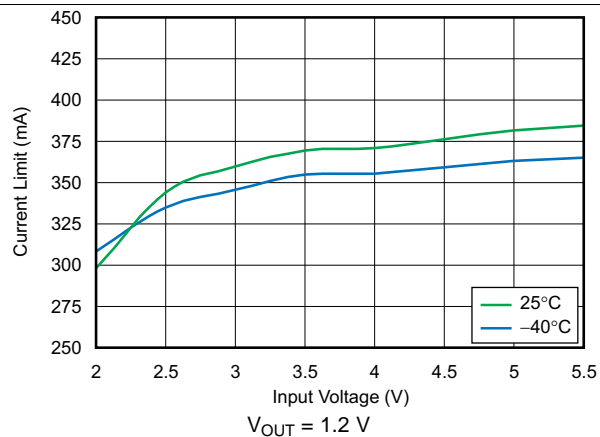

Figure 29. Current Limit vs Input Voltage

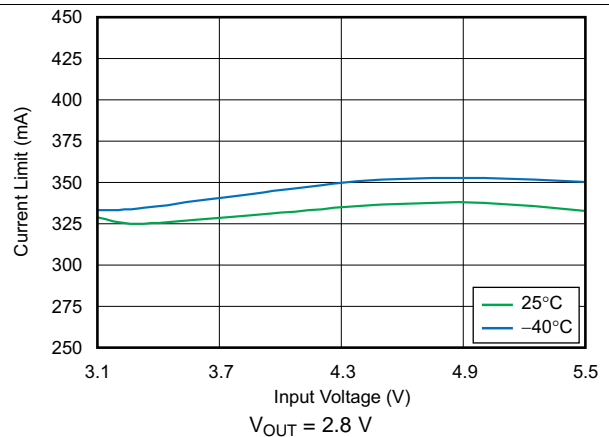

Figure 30. Current Limit vs Input Voltage

### Typical Characteristics (continued)

At  $T_J = -40^\circ\text{C}$  to  $+85^\circ\text{C}$ ,  $V_{IN} = V_{OUT(nom)} + 0.5\text{ V}$  or  $2.0\text{ V}$  (whichever is greater),  $I_{OUT} = 10\text{ mA}$ ,  $V_{EN} = V_{IN}$ , and  $C_{OUT} = 1\ \mu\text{F}$ , unless otherwise noted. Typical values are at  $T_J = 25^\circ\text{C}$ .

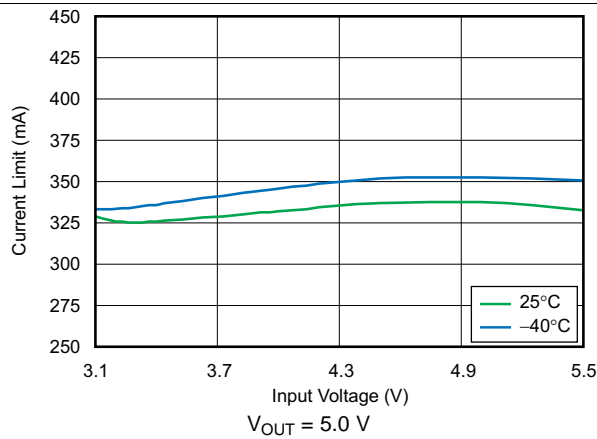

Figure 31. Current Limit vs Input Voltage

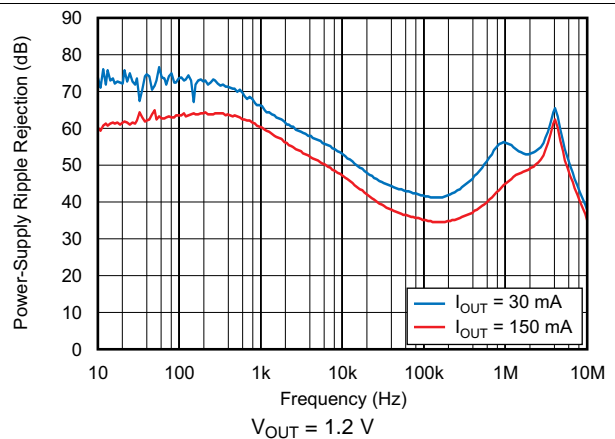

Figure 32. Power-Supply Ripple Rejection vs Frequency

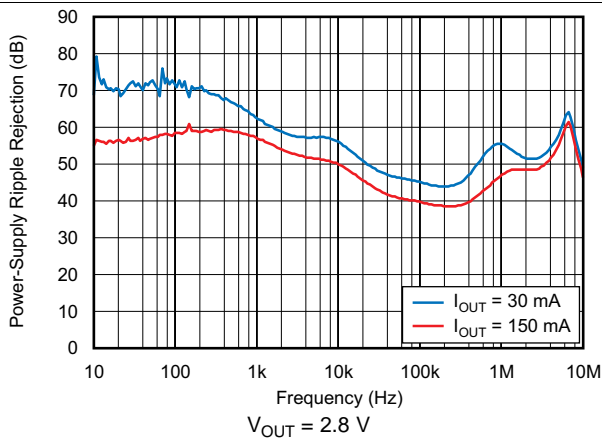

Figure 33. Power-Supply Ripple Rejection vs Frequency

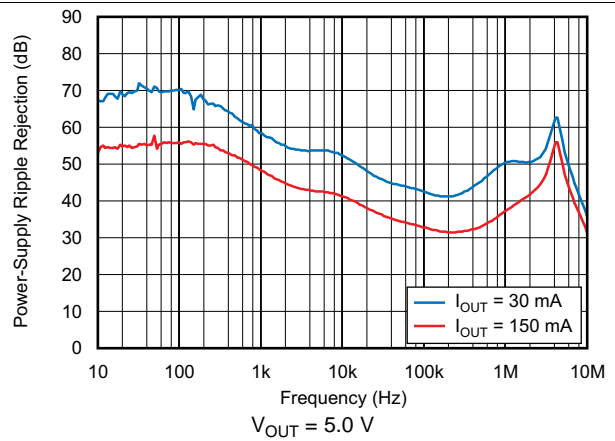

Figure 34. Power-Supply Ripple Rejection vs Frequency

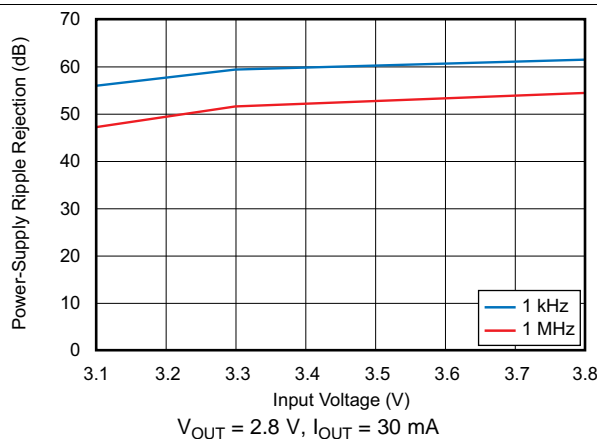

Figure 35. Power-Supply Ripple Rejection vs Input Voltage

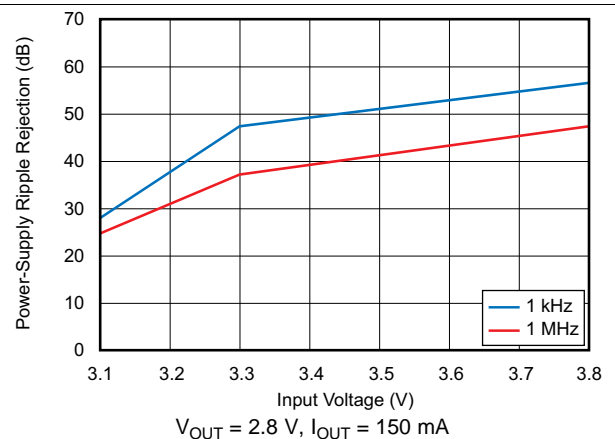

Figure 36. Power-Supply Ripple Rejection vs Input Voltage

Typical Characteristics (continued)

At  $T_J = -40^{\circ}\text{C}$  to  $+85^{\circ}\text{C}$ ,  $V_{IN} = V_{OUT(nom)} + 0.5\text{ V}$  or  $2.0\text{ V}$  (whichever is greater),  $I_{OUT} = 10\text{ mA}$ ,  $V_{EN} = V_{IN}$ , and  $C_{OUT} = 1\text{ }\mu\text{F}$ , unless otherwise noted. Typical values are at  $T_J = 25^{\circ}\text{C}$ .

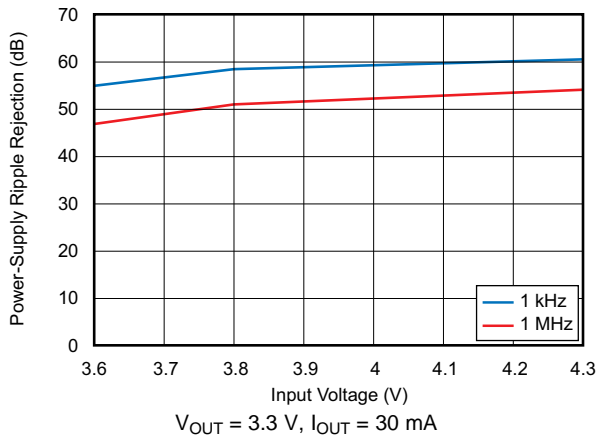

Figure 37. Power-Supply Ripple Rejection vs Input Voltage

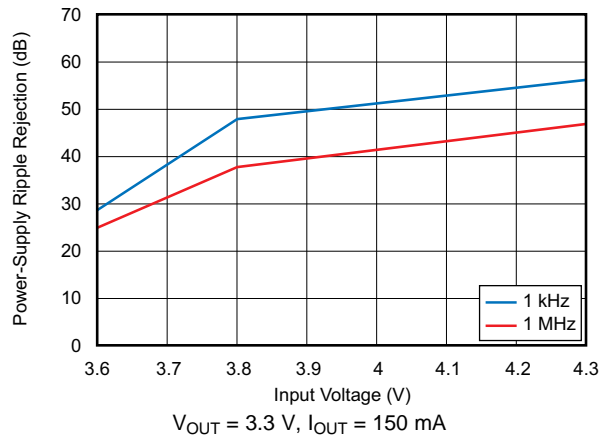

Figure 38. Power-Supply Ripple Rejection vs Input Voltage

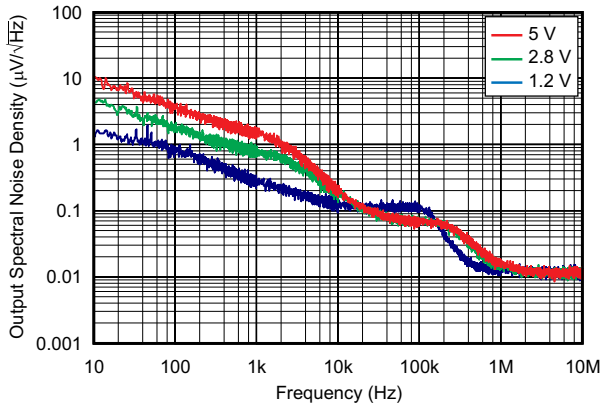

Figure 39. Output Spectral Noise Density vs Frequency

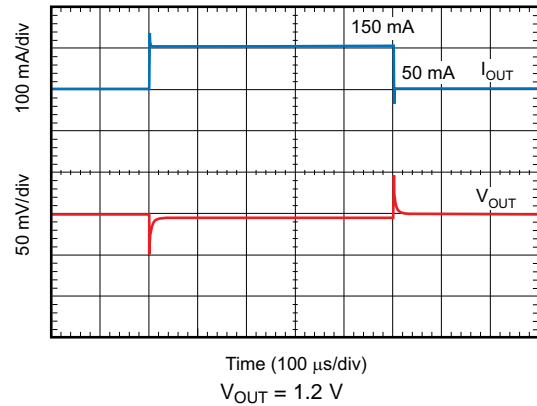

Figure 40. Load Transient Response

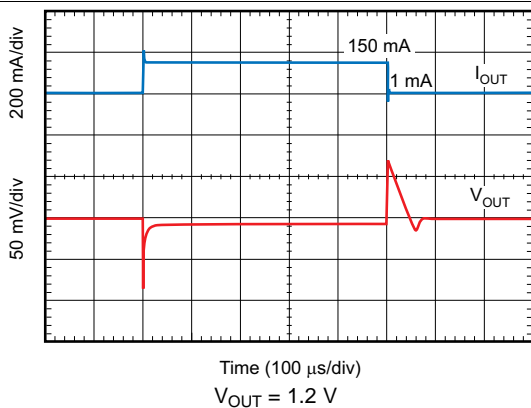

Figure 41. Load Transient Response

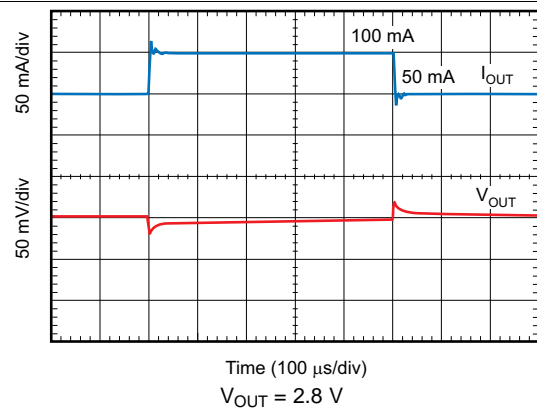

Figure 42. Load Transient Response

Typical Characteristics (continued)

At  $T_J = -40^\circ\text{C}$  to  $+85^\circ\text{C}$ ,  $V_{IN} = V_{OUT(nom)} + 0.5\text{ V}$  or  $2.0\text{ V}$  (whichever is greater),  $I_{OUT} = 10\text{ mA}$ ,  $V_{EN} = V_{IN}$ , and  $C_{OUT} = 1\ \mu\text{F}$ , unless otherwise noted. Typical values are at  $T_J = 25^\circ\text{C}$ .

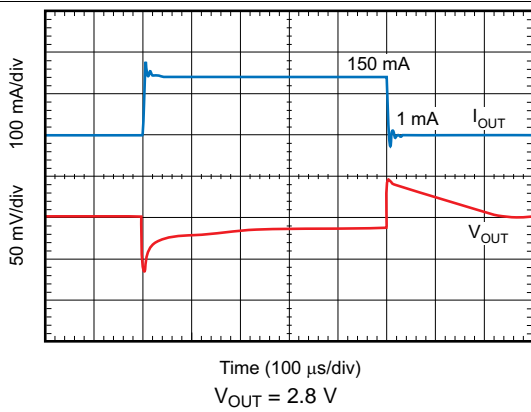

Figure 43. Load Transient Response

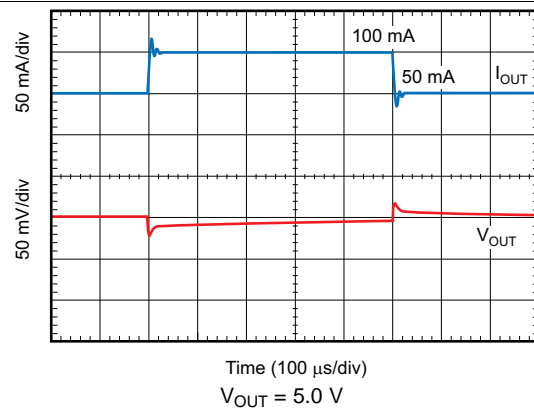

Figure 44. Load Transient Response

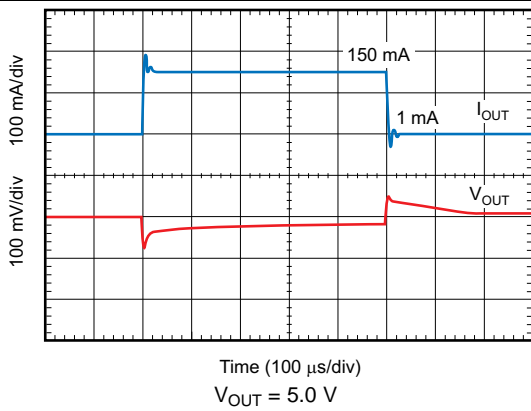

Figure 45. Load Transient Response

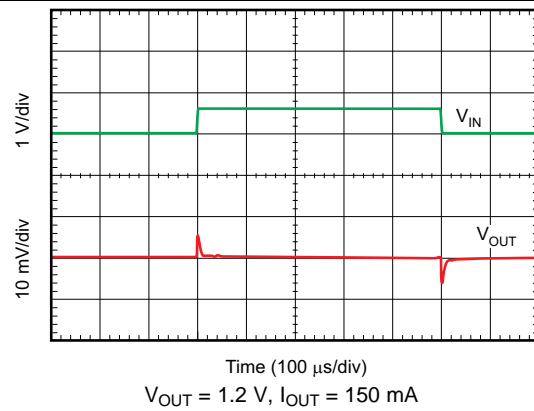

Figure 46. Line Transient Response

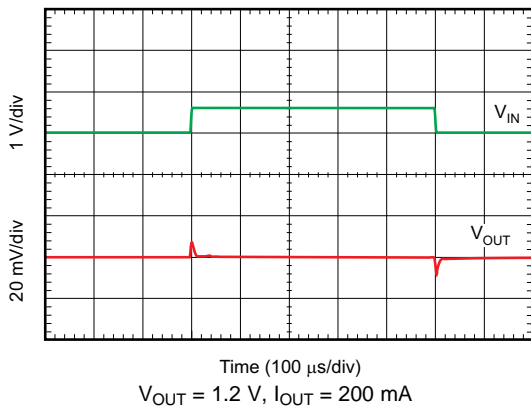

Figure 47. Line Transient Response

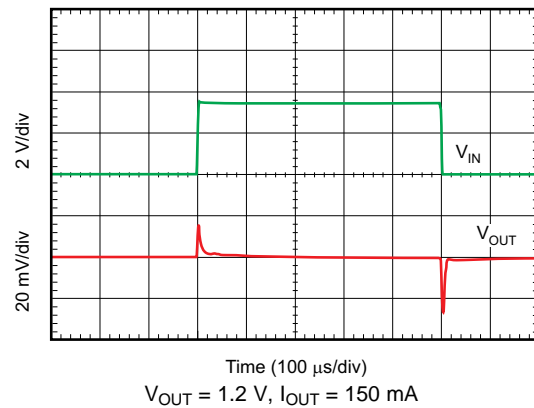
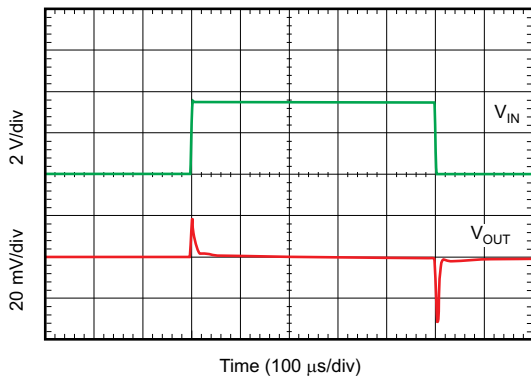

Figure 48. Line Transient Response

Typical Characteristics (continued)

At  $T_J = -40^\circ\text{C}$  to  $+85^\circ\text{C}$ ,  $V_{IN} = V_{OUT(nom)} + 0.5\text{ V}$  or  $2.0\text{ V}$  (whichever is greater),  $I_{OUT} = 10\text{ mA}$ ,  $V_{EN} = V_{IN}$ , and  $C_{OUT} = 1\ \mu\text{F}$ , unless otherwise noted. Typical values are at  $T_J = 25^\circ\text{C}$ .



Time (100  $\mu\text{s}/\text{div}$ )  
 $V_{OUT} = 1.2\text{ V}$ ,  $I_{OUT} = 200\text{ mA}$

Figure 49. Line Transient Response

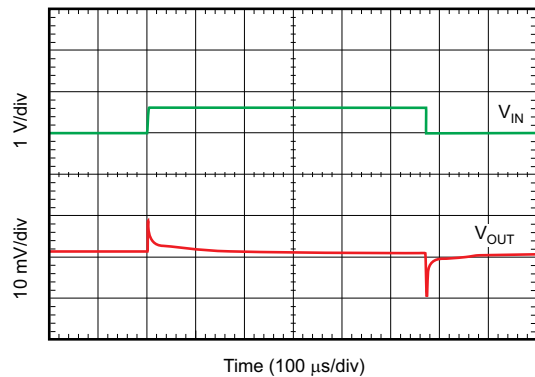

Time (100  $\mu\text{s}/\text{div}$ )  
 $V_{OUT} = 2.8\text{ V}$ ,  $I_{OUT} = 150\text{ mA}$

Figure 50. Line Transient Response

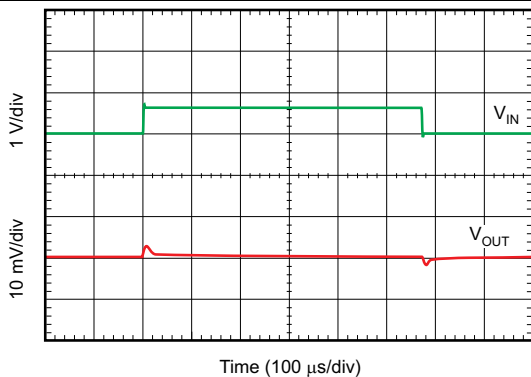

Time (100  $\mu\text{s}/\text{div}$ )  
 $V_{OUT} = 2.8\text{ V}$ ,  $I_{OUT} = 200\text{ mA}$

Figure 51. Line Transient Response

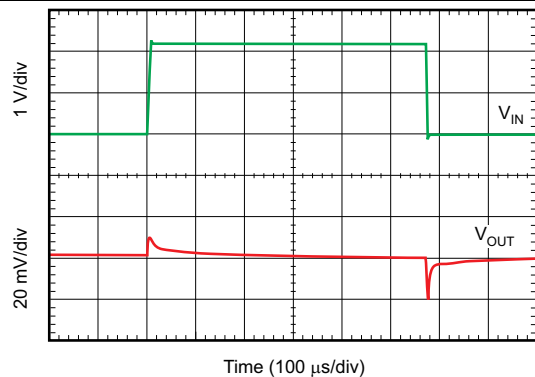

Time (100  $\mu\text{s}/\text{div}$ )  
 $V_{OUT} = 2.8\text{ V}$ ,  $I_{OUT} = 200\text{ mA}$

Figure 52. Line Transient Response

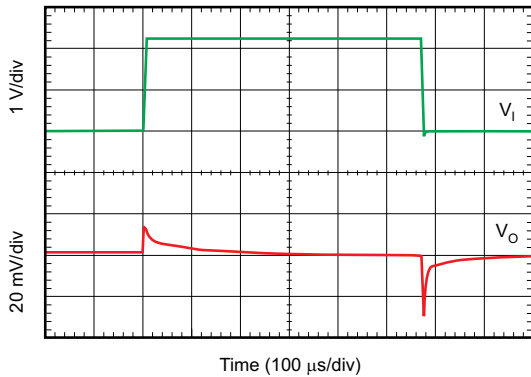

Time (100  $\mu\text{s}/\text{div}$ )  
 $V_{OUT} = 2.8\text{ V}$ ,  $I_{OUT} = 200\text{ mA}$

Figure 53. Line Transient Response

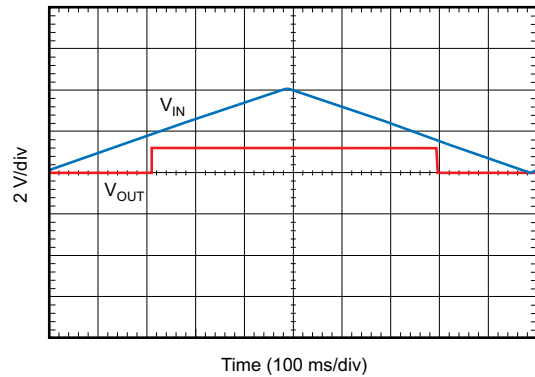

Time (100  $\text{ms}/\text{div}$ )  
 $V_{OUT} = 1.2\text{ V}$ ,  $I_{OUT} = 30\text{ mA}$

Figure 54.  $V_{IN}$  Ramp Up, Ramp Down Response

**Typical Characteristics (continued)**

At  $T_J = -40^\circ\text{C}$  to  $+85^\circ\text{C}$ ,  $V_{IN} = V_{OUT(nom)} + 0.5\text{ V}$  or  $2.0\text{ V}$  (whichever is greater),  $I_{OUT} = 10\text{ mA}$ ,  $V_{EN} = V_{IN}$ , and  $C_{OUT} = 1\ \mu\text{F}$ , unless otherwise noted. Typical values are at  $T_J = 25^\circ\text{C}$ .

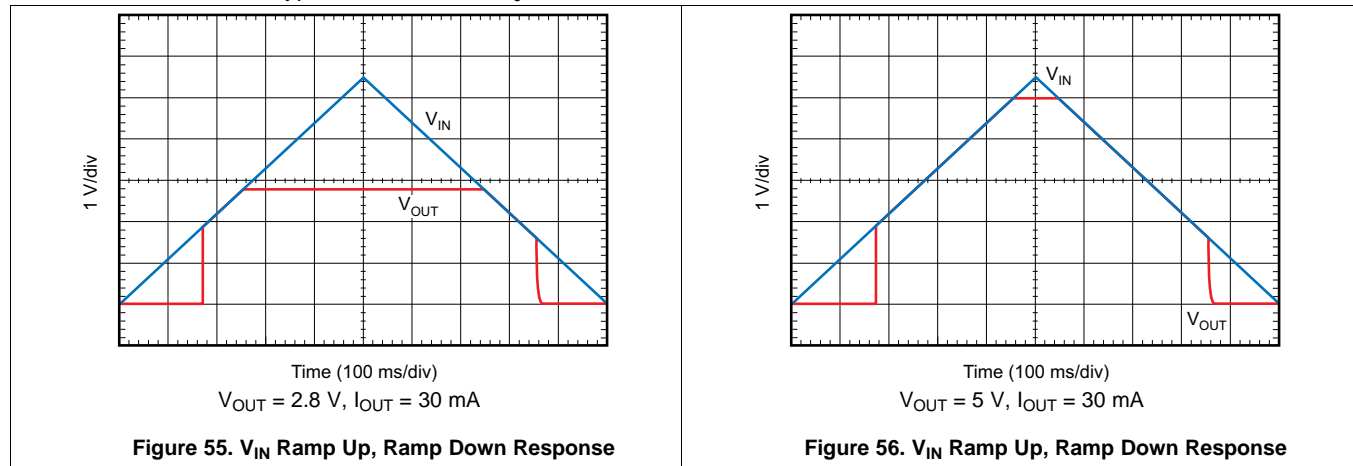



## 7 Detailed Description

### 7.1 Overview

The TLV707 series (TLV707 and TLV707P) belongs to a family of low-dropout regulators (LDOs). This device consumes low quiescent current and delivers excellent line and load transient performance. These characteristics, combined with low noise and very good PSRR with little ( $V_{IN} - V_{OUT}$ ) headroom, make this device ideal for portable RF applications.

### 7.2 Functional Block Diagrams

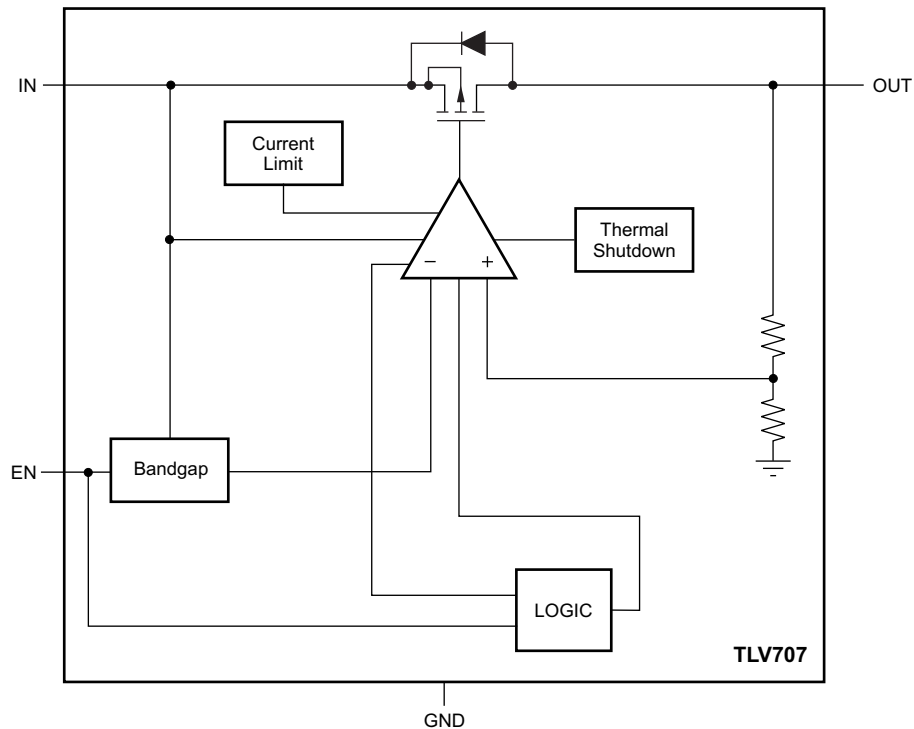
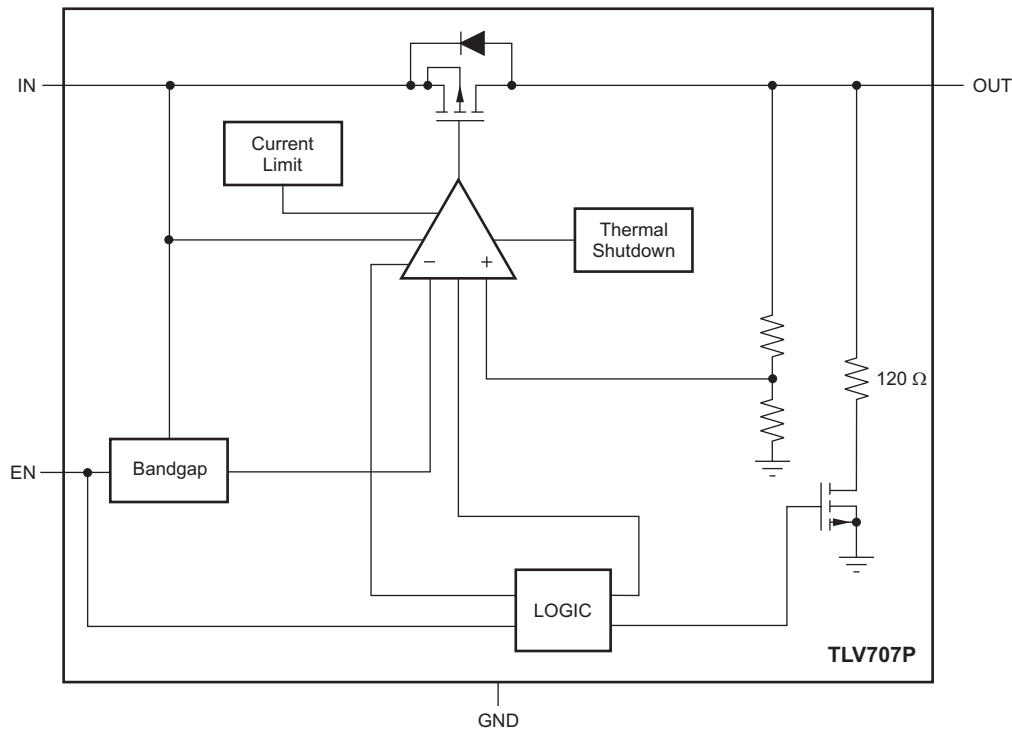

Figure 57. TLV707 Block Diagram

**Functional Block Diagrams (continued)**

**Figure 58. TLV707P Block Diagram**
**7.3 Feature Description**

This LDO regulator offers current limit and thermal protection. The operating junction temperature of this device is  $-40^{\circ}\text{C}$  to  $125^{\circ}\text{C}$ .

**7.3.1 Internal Current Limit**

The internal current limit helps to protect the regulator during fault conditions. During current limit, the output sources a fixed amount of current that is largely independent of the output voltage. In such a case, the output voltage is not regulated, and is  $V_{\text{OUT}} = I_{\text{LIMIT}} \times R_{\text{LOAD}}$ . The PMOS pass transistor dissipates  $(V_{\text{IN}} - V_{\text{OUT}}) \times I_{\text{LIMIT}}$  until thermal shutdown is triggered and the device turns off. When the device cools, the internal thermal shutdown circuit turns the device back on. If the fault condition continues, the device cycles between current limit and thermal shutdown; see the [Thermal Information](#) table for more details.

The PMOS pass element has a built-in body diode that conducts current when the voltage at OUT exceeds the voltage at IN. This current is not limited, so if extended reverse voltage operation is anticipated, external limiting to 5% of the rated output current is recommended.

## Feature Description (continued)

### 7.3.2 Shutdown

The enable pin (EN) is active high. The device is enabled when voltage at the EN pin goes above 0.9 V. This relatively lower voltage value required to turn on the LDO can also be used to power the device when it is connected to a GPIO of a newer processor, where the GPIO Logic 1 voltage level is lower than that of traditional microcontrollers. The device is turned off when the EN pin is held at less than 0.4 V. When shutdown capability is not required, EN can be connected to the IN pin.

The TLV707P version has internal active pulldown circuitry that discharges the output with a time constant as given by [Equation 1](#):

$$\tau = \frac{(120 \cdot R_L)}{(120 + R_L)} \cdot C_{OUT}$$

where:

- $R_L$  = Load resistance
- $C_{OUT}$  = Output capacitor

(1)

## 7.4 Device Functional Modes

The TLV707 series is specified over the recommended operating conditions (see the [Recommended Operating Conditions](#) table). The specifications may not be met when exposed to conditions outside of the recommended operating range.

In order to turn on the regulator, the EN pin must be driven over 0.9 V. Driving the EN pin below 0.4 V causes the regulator to enter shutdown mode.

In shutdown, the current consumption of the device is reduced to 1  $\mu$ A, typically.

## 8 Application and Implementation

### NOTE

Information in the following applications sections is not part of the TI component specification, and TI does not warrant its accuracy or completeness. TI's customers are responsible for determining suitability of components for their purposes. Customers should validate and test their design implementation to confirm system functionality.

### 8.1 Application Information

The TLV707 series is a low-dropout regulator (LDO) with low quiescent current that delivers excellent line and load transient performance. This LDO regulator offers current limit and thermal protection. The operating junction temperature of this device series is  $-40^{\circ}\text{C}$  to  $125^{\circ}\text{C}$ .

### 8.2 Typical Application

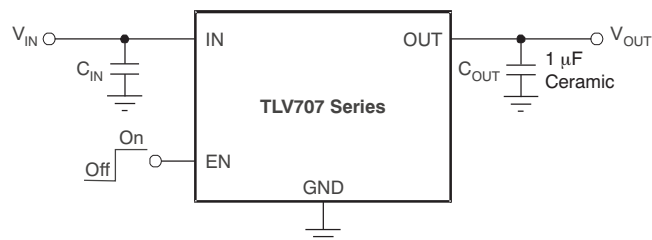

**Figure 59. Typical Application Circuit**

#### 8.2.1 Design Requirements

Provide an input supply with adequate headroom to meet minimum  $V_{IN}$  requirements (as shown in [Table 1](#)), compensate for the GND pin current, and to power the load.

**Table 1. Design Parameters**

PARAMETER	DESIGN REQUIREMENT
Input voltage	1.8 V - 3.6 V
Output voltage	1.2 V
Output current	100-mA

#### 8.2.2 Detailed Design Procedure

##### 8.2.2.1 Input and Output Capacitor Requirements

Generally, 1.0- $\mu\text{F}$  X5R- and X7R-type ceramic capacitors are recommended because these capacitors have minimal variation in value and equivalent series resistance (ESR) over temperature.

However, the TLV707 is designed to be stable with an effective capacitance of 0.1  $\mu\text{F}$  or larger at the output. Thus, the device is stable with capacitors of other dielectric types as well, as long as the effective capacitance under operating bias voltage and temperature is greater than 0.1  $\mu\text{F}$ . This effective capacitance refers to the capacitance that the LDO detects under operating bias voltage and temperature conditions; that is, the capacitance after taking both bias voltage and temperature derating into consideration. In addition to allowing the use of less expensive dielectrics, this capability of being stable with 0.1- $\mu\text{F}$  effective capacitance also enables the use of smaller footprint capacitors that have higher derating in size- and space-constrained applications.

Using a 0.1- $\mu\text{F}$  rated capacitor at the output of the LDO does not ensure stability because the effective capacitance under the specified operating conditions is less than 0.1  $\mu\text{F}$ . Maximum ESR must be less than 200 m $\Omega$ .

Although an input capacitor is not required for stability, good analog design practice is to connect a 0.1- $\mu$ F to 1.0- $\mu$ F, low ESR capacitor across the IN pin and GND pin of the regulator. This capacitor counteracts reactive input sources and improves transient response, noise rejection, and ripple rejection. A higher-value capacitor may be necessary if large, fast rise-time load transients are anticipated, or if the device is not located close to the power source. If source impedance is more than 2- $\Omega$ , a 0.1- $\mu$ F input capacitor may be necessary to ensure stability.

### **8.2.2.2 Dropout Voltage**

The TLV707 series of LDOs use a PMOS pass transistor to achieve low dropout. When  $(V_{IN} - V_{OUT})$  is less than the dropout voltage ( $V_{DO}$ ), the PMOS pass device is in the linear region of operation and the input-to-output resistance is the  $R_{DS(ON)}$  of the PMOS pass element.  $V_{DO}$  scales approximately with output current because the PMOS device functions similar to a resistor in dropout.

As with any linear regulator, PSRR and transient response are degraded when  $(V_{IN} - V_{OUT})$  approaches dropout.

### **8.2.2.3 Transient Response**

As with any regulator, increasing the size of the output capacitor reduces over- and undershoot magnitude but increases the duration of the transient response.

### 8.2.3 Application Curves

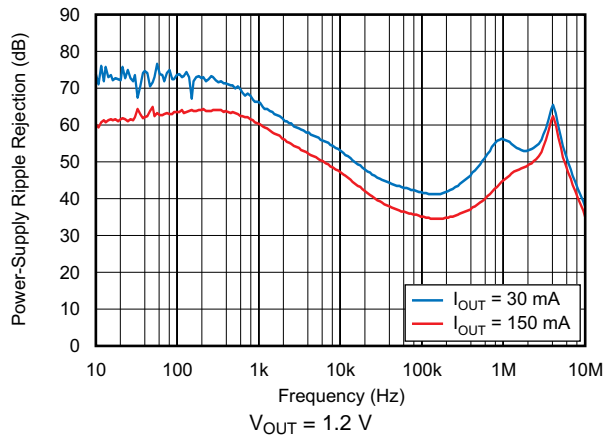

Figure 60. Power-Supply Ripple Rejection vs Frequency

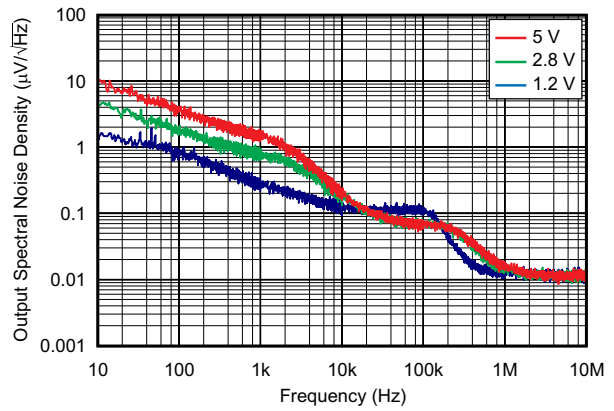

Figure 61. Output Spectral Noise Density vs Frequency

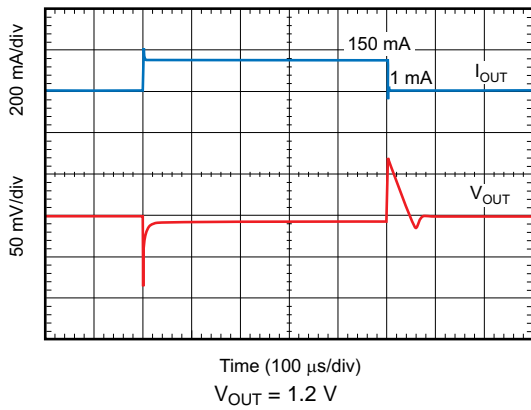

Figure 62. Load Transient Response

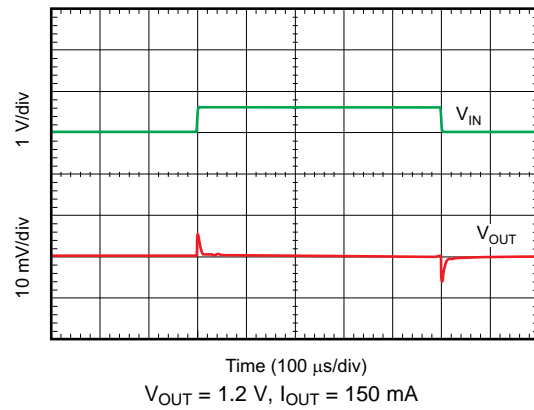

Figure 63. Line Transient Response

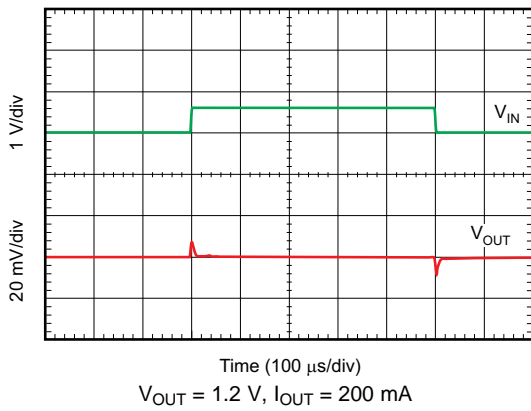

Figure 64. Line Transient Response

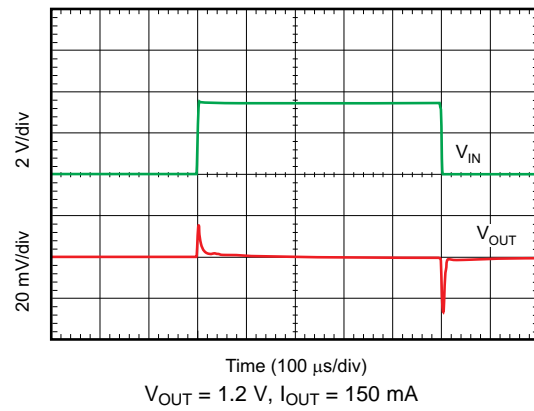
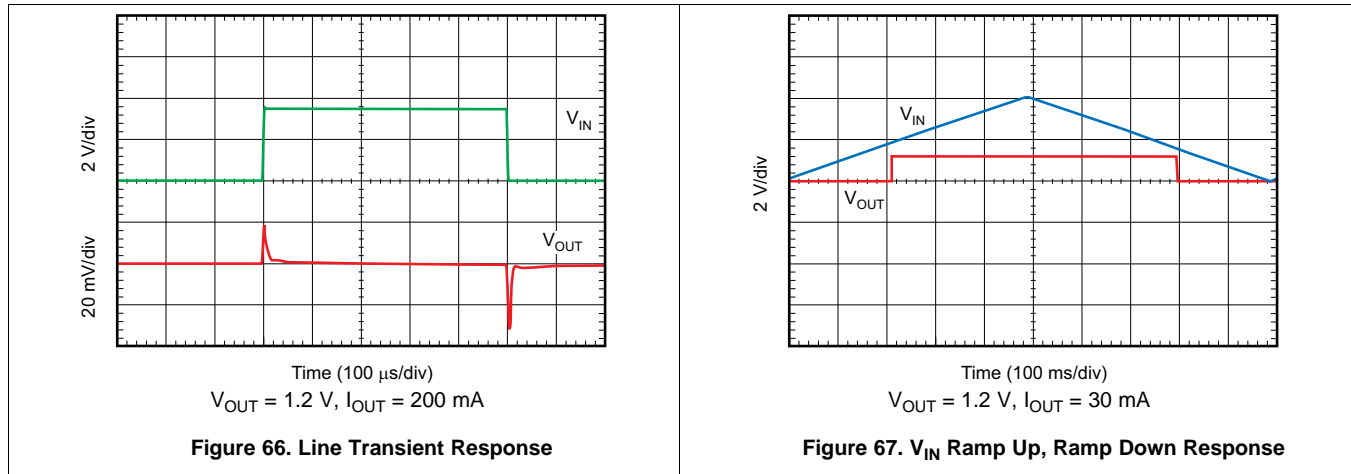

Figure 65. Line Transient Response



### 8.3 Do's and Don'ts

Place at least one 1.0- $\mu$ F ceramic capacitor as close as possible to the OUT pin of the regulator.

Do not place the output capacitor more than 10 mm away from the regulator.

Connect a 1.0- $\mu$ F low equivalent series resistance (ESR) capacitor across the IN pin and GND input of the regulator for improved transient performance.

Do not exceed the absolute maximum ratings.

## 9 Power Supply Recommendations

The device is designed to operate from an input voltage supply range between 2.0 V and 5.5 V. The input voltage range provides adequate headroom in order for the device to have a regulated output. This input supply must be well regulated (see [Figure 46](#) through [Figure 53](#)). If the input supply is noisy, additional input capacitors with low ESR help improve the output noise performance.

## 10 Layout

### 10.1 Layout Guidelines

#### 10.1.1 Board Layout Recommendations to Improve PSRR and Noise Performance

Place input and output capacitors as close to the device pins as possible. To improve ac performance (such as PSRR, output noise, and transient response), TI recommends that the board be designed with separate ground planes for  $V_{IN}$  and  $V_{OUT}$ , with the ground plane connected only at the GND pin of the device, as shown in [Figure 68](#). In addition, connect the ground connection for the output capacitor directly to the GND pin of the device. High ESR capacitors may degrade PSRR performance.

#### 10.1.2 Package Mounting

Solder pad footprint recommendations are available from TI's website at [www.ti.com](http://www.ti.com). The recommended land pattern for the DQN (X2SON-4) package is provided in [机械、封装和可订购信息](#).

### 10.2 Layout Example

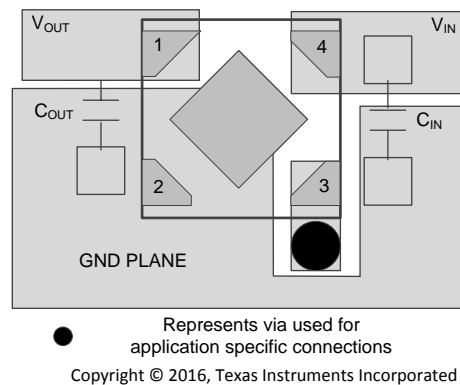

**Figure 68. Recommended Layout Example**

### 10.3 Thermal Considerations

Thermal protection disables the output when the junction temperature rises to approximately 160°C, allowing the device to cool. When the junction temperature cools to approximately 140°C, the output circuitry is again enabled. Depending on power dissipation, thermal resistance, and ambient temperature, the thermal protection circuit may cycle on and off. This cycling limits the dissipation of the regulator, thus protecting the regulator from damage as a result of overheating.

Any tendency to activate the thermal protection circuit indicates excessive power dissipation or an inadequate heatsink. For reliable operation, limit junction temperature to 125°C (maximum). To estimate the margin of safety in a complete design (including heatsink), increase the ambient temperature until the thermal protection is triggered; use worst-case loads and signal conditions.

For good reliability, thermal protection triggers at least 35°C above the maximum expected ambient condition of the particular application. This configuration produces a worst-case junction temperature of 125°C at the highest expected ambient temperature and worst-case load.



## Thermal Considerations (接下页)

The internal protection circuitry of the LDO is designed to protect against overload conditions. This circuitry is not intended to replace proper heatsinking. Continuously running the LDO into thermal shutdown degrades device reliability.

### 10.4 Power Dissipation

The ability to remove heat from the die is different for each package type, presenting different considerations in the printed-circuit-board (PCB) layout. The PCB area around the device that is free of other components moves the heat from the device to the ambient air.

Performance data for JEDEC low- and high-K boards are given in the [Thermal Information](#) table. Using heavier copper increases the effectiveness in removing heat from the device. The addition of plated through-holes to heat-dissipating layers also improves heatsink effectiveness.

Power dissipation depends on input voltage and load conditions. Power dissipation ( $P_D$ ) is equal to the product of the output current and the voltage drop across the output pass element, as shown in [Equation 2](#).

$$P_D = (V_{IN} - V_{OUT}) \times I_{OUT} \quad (2)$$

## 11 器件和文档支持

### 11.1 器件支持

#### 11.1.1 开发支持

##### 11.1.1.1 评估模块

评估模块 (EVM) 可与 TLV707 和 TLV707P 配套使用, 帮助评估初始电路性能。SLVU416 详细介绍了 TLV70728EVM-612 的设计套件和评估模块。

EVM 可通过德州仪器 (TI) 网站上的 [TLV707](#) 和 [TLV707P](#) 产品文件夹获取, 也可直接从 [TI 网上商店](#) 购买。

##### 11.1.1.2 Spice 模型

分析模拟电路和系统的性能时, 使用 SPICE 模型对电路性能进行计算机仿真非常有用。您可以从相应器件产品文件夹中的 *仿真模型* 下获取 TLV707 和 TLV707P 的 SPICE 模型。

#### 11.1.2 器件命名规则

表 2. 订购信息<sup>(1)</sup>

产品	V <sub>OUT</sub> <sup>(2)</sup>
TLV707xx(x)Pyyyz	<b>XX(X)</b> 是标称输出电压。对于分辨率为 100mV 的输出电压, 订货编号中使用两位数字; 否则, 使用三位数字 (例如, 18 = 1.8V, 285 = 2.85V)。 <b>P</b> 为可选项; P 表示器件具有一个带有源输出放电功能的 LDO 稳压器。 <b>YYY</b> 为封装标识符。 <b>Z</b> 为封装数量。R 表示卷 (3000 片), T 表示带 (250 片)。

(1) 要获得最新的封装和订货信息, 请参阅本文档末尾的封装选项附录, 或者访问器件产品文件夹, 此文件夹位于 [www.ti.com.cn](http://www.ti.com.cn) 内。

(2) 输出电压范围为 0.85V 至 5.0V (以 50mV 为单位增量)。更多详细信息及可用性, 请联系制造商。

### 11.2 文档支持

#### 11.2.1 相关文档

请参阅如下相关文档:

[TLV70728EVM-612 评估模块](#)

#### 11.3 相关链接

表 3 列出了快速访问链接。类别包括技术文档、支持和社区资源、工具和软件, 以及立即购买的快速链接。

表 3. 相关链接

器件	产品文件夹	立即订购	技术文档	工具和软件	支持和社区
TLV707	<a href="#">请单击此处</a>	<a href="#">请单击此处</a>	<a href="#">请单击此处</a>	<a href="#">请单击此处</a>	<a href="#">请单击此处</a>
TLV707P	<a href="#">请单击此处</a>	<a href="#">请单击此处</a>	<a href="#">请单击此处</a>	<a href="#">请单击此处</a>	<a href="#">请单击此处</a>

#### 11.4 接收文档更新通知

要接收文档更新通知, 请导航至 [TI.com.cn](http://TI.com.cn) 上的器件产品文件夹。单击右上角的 *通知我* 进行注册, 即可每周接收产品信息更改摘要。有关更改的详细信息, 请查看任何已修订文档中包含的修订历史记录。

#### 11.5 社区资源

下列链接提供到 TI 社区资源的连接。链接的内容由各个分销商“按照原样”提供。这些内容并不构成 TI 技术规范, 并且不一定反映 TI 的观点; 请参阅 TI 的 [《使用条款》](#)。

**TI E2E™ 在线社区** *TI 的工程师对工程师 (E2E) 社区*。此社区的创建目的在于促进工程师之间的协作。在 [e2e.ti.com](http://e2e.ti.com) 中, 您可以咨询问题、分享知识、拓展思路并与同行工程师一道帮助解决问题。

**设计支持** *TI 参考设计支持* 可帮助您快速查找有帮助的 E2E 论坛、设计支持工具以及技术支持的联系信息。

## 11.6 商标

E2E is a trademark of Texas Instruments.  
All other trademarks are the property of their respective owners.

## 11.7 静电放电警告



这些装置包含有限的内置 ESD 保护。存储或装卸时，应将导线一起截短或将装置放置于导电泡棉中，以防止 MOS 门极遭受静电损伤。

## 11.8 术语表

[SLYZ022](#) — TI 术语表。

这份术语表列出并解释术语、缩写和定义。

## 12 机械、封装和可订购信息

以下页面包含机械、封装和可订购信息。这些信息是针对指定器件系列提供的最新数据。数据如有变更，恕不另行通知，且不会对此文档进行修订。如需获取此数据表的浏览器版本，请参阅左侧的导航栏。

**PACKAGING INFORMATION**

Orderable Device	Status (1)	Package Type	Package Drawing	Pins	Package Qty	Eco Plan (2)	Lead finish/ Ball material (6)	MSL Peak Temp (3)	Op Temp (°C)	Device Marking (4/5)	Samples
TLV707085DQNR	ACTIVE	X2SON	DQN	4	3000	RoHS & Green	NIPDAU	Level-1-260C-UNLIM	-40 to 125	BY	<a href="#">Samples</a>
TLV707085DQNT	ACTIVE	X2SON	DQN	4	250	RoHS & Green	NIPDAU	Level-1-260C-UNLIM	-40 to 125	BY	<a href="#">Samples</a>
TLV70710DQNR	ACTIVE	X2SON	DQN	4	3000	RoHS & Green	NIPDAU   NIPDAUAG	Level-1-260C-UNLIM	-40 to 125	BB	<a href="#">Samples</a>
TLV70710DQNT	ACTIVE	X2SON	DQN	4	250	RoHS & Green	NIPDAU   NIPDAUAG	Level-1-260C-UNLIM	-40 to 125	BB	<a href="#">Samples</a>
TLV70710PDQNR	ACTIVE	X2SON	DQN	4	3000	RoHS & Green	NIPDAU   NIPDAUAG	Level-1-260C-UNLIM	-40 to 125	BC	<a href="#">Samples</a>
TLV70710PDQNT	ACTIVE	X2SON	DQN	4	250	RoHS & Green	NIPDAU   NIPDAUAG	Level-1-260C-UNLIM	-40 to 125	BC	<a href="#">Samples</a>
TLV707115DQNR	ACTIVE	X2SON	DQN	4	3000	RoHS & Green	NIPDAU   NIPDAUAG	Level-1-260C-UNLIM	-40 to 125	B3	<a href="#">Samples</a>
TLV707115DQNT	ACTIVE	X2SON	DQN	4	250	RoHS & Green	NIPDAU   NIPDAUAG	Level-1-260C-UNLIM	-40 to 125	B3	<a href="#">Samples</a>
TLV70711PDQNR	ACTIVE	X2SON	DQN	4	3000	RoHS & Green	NIPDAU	Level-1-260C-UNLIM	-40 to 125	C3	<a href="#">Samples</a>
TLV70711PDQNT	ACTIVE	X2SON	DQN	4	250	RoHS & Green	NIPDAU	Level-1-260C-UNLIM	-40 to 125	C3	<a href="#">Samples</a>
TLV70712PDQNR	ACTIVE	X2SON	DQN	4	3000	RoHS & Green	NIPDAU   NIPDAUAG	Level-1-260C-UNLIM	-40 to 125	WJ	<a href="#">Samples</a>
TLV70712PDQNT	ACTIVE	X2SON	DQN	4	250	RoHS & Green	NIPDAU   NIPDAUAG	Level-1-260C-UNLIM	-40 to 125	WJ	<a href="#">Samples</a>
TLV707135DQNR	ACTIVE	X2SON	DQN	4	3000	RoHS & Green	NIPDAU	Level-1-260C-UNLIM	-40 to 125	BD	<a href="#">Samples</a>
TLV707135DQNT	ACTIVE	X2SON	DQN	4	250	RoHS & Green	NIPDAU	Level-1-260C-UNLIM	-40 to 125	BD	<a href="#">Samples</a>
TLV70715PDQNR	ACTIVE	X2SON	DQN	4	3000	RoHS & Green	NIPDAU   NIPDAUAG	Level-1-260C-UNLIM	-40 to 125	WI	<a href="#">Samples</a>
TLV70715PDQNT	ACTIVE	X2SON	DQN	4	250	RoHS & Green	NIPDAU   NIPDAUAG	Level-1-260C-UNLIM	-40 to 125	WI	<a href="#">Samples</a>
TLV70717DQNR	ACTIVE	X2SON	DQN	4	3000	RoHS & Green	NIPDAU	Level-1-260C-UNLIM	-40 to 125	GD	<a href="#">Samples</a>
TLV70717DQNT	ACTIVE	X2SON	DQN	4	250	RoHS & Green	NIPDAU	Level-1-260C-UNLIM	-40 to 125	GD	<a href="#">Samples</a>
TLV707185DQNR	ACTIVE	X2SON	DQN	4	3000	RoHS & Green	NIPDAU   NIPDAUAG	Level-1-260C-UNLIM	-40 to 125	ZN	<a href="#">Samples</a>
TLV707185DQNT	ACTIVE	X2SON	DQN	4	250	RoHS & Green	NIPDAU   NIPDAUAG	Level-1-260C-UNLIM	-40 to 125	ZN	<a href="#">Samples</a>

Orderable Device	Status (1)	Package Type	Package Drawing	Pins	Package Qty	Eco Plan (2)	Lead finish/ Ball material (6)	MSL Peak Temp (3)	Op Temp (°C)	Device Marking (4/5)	Samples
TLV707185PDQNR	ACTIVE	X2SON	DQN	4	3000	RoHS & Green	NIPDAU   NIPDAUAG	Level-1-260C-UNLIM	-40 to 125	B1	<a href="#">Samples</a>
TLV707185PDQNT	ACTIVE	X2SON	DQN	4	250	RoHS & Green	NIPDAU   NIPDAUAG	Level-1-260C-UNLIM	-40 to 125	B1	<a href="#">Samples</a>
TLV70718DQNR	ACTIVE	X2SON	DQN	4	3000	RoHS & Green	NIPDAU   NIPDAUAG	Level-1-260C-UNLIM	-40 to 125	ZC	<a href="#">Samples</a>
TLV70718DQNT	ACTIVE	X2SON	DQN	4	250	RoHS & Green	NIPDAU   NIPDAUAG	Level-1-260C-UNLIM	-40 to 125	ZC	<a href="#">Samples</a>
TLV70718PDQNR	ACTIVE	X2SON	DQN	4	3000	RoHS & Green	NIPDAU   NIPDAUAG	Level-1-260C-UNLIM	-40 to 125	SB	<a href="#">Samples</a>
TLV70718PDQNT	ACTIVE	X2SON	DQN	4	250	RoHS & Green	NIPDAU   NIPDAUAG	Level-1-260C-UNLIM	-40 to 125	SB	<a href="#">Samples</a>
TLV70719PDQNR	ACTIVE	X2SON	DQN	4	3000	RoHS & Green	NIPDAU   NIPDAUAG	Level-1-260C-UNLIM	-40 to 125	ZM	<a href="#">Samples</a>
TLV70719PDQNT	ACTIVE	X2SON	DQN	4	250	RoHS & Green	NIPDAU   NIPDAUAG	Level-1-260C-UNLIM	-40 to 125	ZM	<a href="#">Samples</a>
TLV70725DQNR	ACTIVE	X2SON	DQN	4	3000	RoHS & Green	NIPDAU	Level-1-260C-UNLIM	-40 to 125	BM	<a href="#">Samples</a>
TLV70725DQNT	ACTIVE	X2SON	DQN	4	250	RoHS & Green	NIPDAU	Level-1-260C-UNLIM	-40 to 125	BM	<a href="#">Samples</a>
TLV70725PDQNR	ACTIVE	X2SON	DQN	4	3000	RoHS & Green	NIPDAU   NIPDAUAG	Level-1-260C-UNLIM	-40 to 125	AT	<a href="#">Samples</a>
TLV70725PDQNT	ACTIVE	X2SON	DQN	4	250	RoHS & Green	NIPDAU   NIPDAUAG	Level-1-260C-UNLIM	-40 to 125	AT	<a href="#">Samples</a>
TLV70726DQNR	ACTIVE	X2SON	DQN	4	3000	RoHS & Green	NIPDAU   NIPDAUAG	Level-1-260C-UNLIM	-40 to 125	RF	<a href="#">Samples</a>
TLV70726DQNT	ACTIVE	X2SON	DQN	4	250	RoHS & Green	NIPDAU   NIPDAUAG	Level-1-260C-UNLIM	-40 to 125	RF	<a href="#">Samples</a>
TLV70726PDQNR	ACTIVE	X2SON	DQN	4	3000	RoHS & Green	NIPDAU   NIPDAUAG	Level-1-260C-UNLIM	-40 to 125	SC	<a href="#">Samples</a>
TLV70726PDQNT	ACTIVE	X2SON	DQN	4	250	RoHS & Green	NIPDAU   NIPDAUAG	Level-1-260C-UNLIM	-40 to 125	SC	<a href="#">Samples</a>
TLV70727PDQNR	ACTIVE	X2SON	DQN	4	3000	RoHS & Green	NIPDAU	Level-1-260C-UNLIM	-40 to 125	C6	<a href="#">Samples</a>
TLV70727PDQNT	ACTIVE	X2SON	DQN	4	250	RoHS & Green	NIPDAU	Level-1-260C-UNLIM	-40 to 125	C6	<a href="#">Samples</a>
TLV707285DQNR	ACTIVE	X2SON	DQN	4	3000	RoHS & Green	NIPDAU   NIPDAUAG	Level-1-260C-UNLIM	-40 to 125	RZ	<a href="#">Samples</a>
TLV707285DQNT	ACTIVE	X2SON	DQN	4	250	RoHS & Green	NIPDAU   NIPDAUAG	Level-1-260C-UNLIM	-40 to 125	RZ	<a href="#">Samples</a>
TLV707285PDQNR	ACTIVE	X2SON	DQN	4	3000	RoHS & Green	NIPDAU   NIPDAUAG	Level-1-260C-UNLIM	-40 to 125	XE	<a href="#">Samples</a>

Orderable Device	Status (1)	Package Type	Package Drawing	Pins	Package Qty	Eco Plan (2)	Lead finish/ Ball material (6)	MSL Peak Temp (3)	Op Temp (°C)	Device Marking (4/5)	Samples
TLV707285PDQNT	ACTIVE	X2SON	DQN	4	250	RoHS & Green	NIPDAU   NIPDAUAG	Level-1-260C-UNLIM	-40 to 125	XE	<a href="#">Samples</a>
TLV70728PDQNR	ACTIVE	X2SON	DQN	4	3000	RoHS & Green	NIPDAU   NIPDAUAG	Level-1-260C-UNLIM	-40 to 125	SD	<a href="#">Samples</a>
TLV70728PDQNT	ACTIVE	X2SON	DQN	4	250	RoHS & Green	NIPDAU   NIPDAUAG	Level-1-260C-UNLIM	-40 to 125	SD	<a href="#">Samples</a>
TLV70729DQNR	ACTIVE	X2SON	DQN	4	3000	RoHS & Green	NIPDAU   NIPDAUAG	Level-1-260C-UNLIM	-40 to 125	BF	<a href="#">Samples</a>
TLV70729DQNT	ACTIVE	X2SON	DQN	4	250	RoHS & Green	NIPDAU   NIPDAUAG	Level-1-260C-UNLIM	-40 to 125	BF	<a href="#">Samples</a>
TLV70729PDQNR	ACTIVE	X2SON	DQN	4	3000	RoHS & Green	NIPDAU   NIPDAUAG	Level-1-260C-UNLIM	-40 to 125	BG	<a href="#">Samples</a>
TLV70729PDQNT	ACTIVE	X2SON	DQN	4	250	RoHS & Green	NIPDAU   NIPDAUAG	Level-1-260C-UNLIM	-40 to 125	BG	<a href="#">Samples</a>
TLV70730DQNR	ACTIVE	X2SON	DQN	4	3000	RoHS & Green	NIPDAU   NIPDAUAG	Level-1-260C-UNLIM	-40 to 125	HJ	<a href="#">Samples</a>
TLV70730DQNT	ACTIVE	X2SON	DQN	4	250	RoHS & Green	NIPDAU   NIPDAUAG	Level-1-260C-UNLIM	-40 to 125	HJ	<a href="#">Samples</a>
TLV70730PDQNR	ACTIVE	X2SON	DQN	4	3000	RoHS & Green	NIPDAU   NIPDAUAG	Level-1-260C-UNLIM	-40 to 125	SE	<a href="#">Samples</a>
TLV70730PDQNT	ACTIVE	X2SON	DQN	4	250	RoHS & Green	NIPDAU   NIPDAUAG	Level-1-260C-UNLIM	-40 to 125	SE	<a href="#">Samples</a>
TLV70731DQNR	ACTIVE	X2SON	DQN	4	3000	RoHS & Green	NIPDAU	Level-1-260C-UNLIM	-40 to 125	DI	<a href="#">Samples</a>
TLV70731DQNT	ACTIVE	X2SON	DQN	4	250	RoHS & Green	NIPDAU	Level-1-260C-UNLIM	-40 to 125	DI	<a href="#">Samples</a>
TLV70732DQNR	ACTIVE	X2SON	DQN	4	3000	RoHS & Green	NIPDAU	Level-1-260C-UNLIM	-40 to 125	C8	<a href="#">Samples</a>
TLV70732DQNT	ACTIVE	X2SON	DQN	4	250	RoHS & Green	NIPDAU	Level-1-260C-UNLIM	-40 to 125	C8	<a href="#">Samples</a>
TLV707335DQNR	ACTIVE	X2SON	DQN	4	3000	RoHS & Green	NIPDAU	Level-1-260C-UNLIM	-40 to 125	F6	<a href="#">Samples</a>
TLV707335DQNT	ACTIVE	X2SON	DQN	4	250	RoHS & Green	NIPDAU	Level-1-260C-UNLIM	-40 to 125	F6	<a href="#">Samples</a>
TLV70733DQNR	ACTIVE	X2SON	DQN	4	3000	RoHS & Green	NIPDAU	Level-1-260C-UNLIM	-40 to 125	YH	<a href="#">Samples</a>
TLV70733DQNR1	ACTIVE	X2SON	DQN	4	3000	RoHS & Green	NIPDAU	Level-1-260C-UNLIM	-40 to 125	BN	<a href="#">Samples</a>
TLV70733DQNT	ACTIVE	X2SON	DQN	4	250	RoHS & Green	NIPDAU	Level-1-260C-UNLIM	-40 to 125	YH	<a href="#">Samples</a>
TLV70733PDQNR	ACTIVE	X2SON	DQN	4	3000	RoHS & Green	NIPDAU   NIPDAUAG	Level-1-260C-UNLIM	-40 to 125	TI	<a href="#">Samples</a>

Orderable Device	Status (1)	Package Type	Package Drawing	Pins	Package Qty	Eco Plan (2)	Lead finish/ Ball material (6)	MSL Peak Temp (3)	Op Temp (°C)	Device Marking (4/5)	Samples
TLV70733PDQNT	ACTIVE	X2SON	DQN	4	250	RoHS & Green	NIPDAU   NIPDAUAG	Level-1-260C-UNLIM	-40 to 125	TI	<a href="#">Samples</a>
TLV70734DQNR	ACTIVE	X2SON	DQN	4	3000	RoHS & Green	NIPDAU   NIPDAUAG	Level-1-260C-UNLIM	-40 to 125	AQ	<a href="#">Samples</a>
TLV70734DQNT	ACTIVE	X2SON	DQN	4	250	RoHS & Green	NIPDAU   NIPDAUAG	Level-1-260C-UNLIM	-40 to 125	AQ	<a href="#">Samples</a>
TLV70734PDQNR	ACTIVE	X2SON	DQN	4	3000	RoHS & Green	NIPDAU	Level-1-260C-UNLIM	-40 to 125	AP	<a href="#">Samples</a>
TLV70734PDQNT	ACTIVE	X2SON	DQN	4	250	RoHS & Green	NIPDAU	Level-1-260C-UNLIM	-40 to 125	AP	<a href="#">Samples</a>
TLV70736DQNR	ACTIVE	X2SON	DQN	4	3000	RoHS & Green	NIPDAU   NIPDAUAG	Level-1-260C-UNLIM	-40 to 125	CC	<a href="#">Samples</a>
TLV70736DQNT	ACTIVE	X2SON	DQN	4	250	RoHS & Green	NIPDAU   NIPDAUAG	Level-1-260C-UNLIM	-40 to 125	CC	<a href="#">Samples</a>
TLV70736PDQNR	ACTIVE	X2SON	DQN	4	3000	RoHS & Green	NIPDAU	Level-1-260C-UNLIM	-40 to 125	ZO	<a href="#">Samples</a>
TLV70736PDQNT	ACTIVE	X2SON	DQN	4	250	RoHS & Green	NIPDAU	Level-1-260C-UNLIM	-40 to 125	ZO	<a href="#">Samples</a>

(1) The marketing status values are defined as follows:

**ACTIVE:** Product device recommended for new designs.

**LIFEBUY:** TI has announced that the device will be discontinued, and a lifetime-buy period is in effect.

**NRND:** Not recommended for new designs. Device is in production to support existing customers, but TI does not recommend using this part in a new design.

**PREVIEW:** Device has been announced but is not in production. Samples may or may not be available.

**OBSOLETE:** TI has discontinued the production of the device.

(2) **RoHS:** TI defines "RoHS" to mean semiconductor products that are compliant with the current EU RoHS requirements for all 10 RoHS substances, including the requirement that RoHS substance do not exceed 0.1% by weight in homogeneous materials. Where designed to be soldered at high temperatures, "RoHS" products are suitable for use in specified lead-free processes. TI may reference these types of products as "Pb-Free".

**RoHS Exempt:** TI defines "RoHS Exempt" to mean products that contain lead but are compliant with EU RoHS pursuant to a specific EU RoHS exemption.

**Green:** TI defines "Green" to mean the content of Chlorine (Cl) and Bromine (Br) based flame retardants meet JS709B low halogen requirements of <=1000ppm threshold. Antimony trioxide based flame retardants must also meet the <=1000ppm threshold requirement.

(3) MSL, Peak Temp. - The Moisture Sensitivity Level rating according to the JEDEC industry standard classifications, and peak solder temperature.

(4) There may be additional marking, which relates to the logo, the lot trace code information, or the environmental category on the device.

(5) Multiple Device Markings will be inside parentheses. Only one Device Marking contained in parentheses and separated by a "-" will appear on a device. If a line is indented then it is a continuation of the previous line and the two combined represent the entire Device Marking for that device.

<sup>(6)</sup> Lead finish/Ball material - Orderable Devices may have multiple material finish options. Finish options are separated by a vertical ruled line. Lead finish/Ball material values may wrap to two lines if the finish value exceeds the maximum column width.

**Important Information and Disclaimer:** The information provided on this page represents TI's knowledge and belief as of the date that it is provided. TI bases its knowledge and belief on information provided by third parties, and makes no representation or warranty as to the accuracy of such information. Efforts are underway to better integrate information from third parties. TI has taken and continues to take reasonable steps to provide representative and accurate information but may not have conducted destructive testing or chemical analysis on incoming materials and chemicals. TI and TI suppliers consider certain information to be proprietary, and thus CAS numbers and other limited information may not be available for release.

In no event shall TI's liability arising out of such information exceed the total purchase price of the TI part(s) at issue in this document sold by TI to Customer on an annual basis.



## TAPE AND REEL INFORMATION



### QUADRANT ASSIGNMENTS FOR PIN 1 ORIENTATION IN TAPE

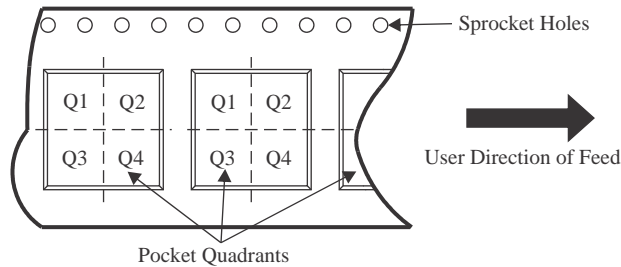

\*All dimensions are nominal

Device	Package Type	Package Drawing	Pins	SPQ	Reel Diameter (mm)	Reel Width W1 (mm)	A0 (mm)	B0 (mm)	K0 (mm)	P1 (mm)	W (mm)	Pin1 Quadrant
TLV707085DQNR	X2SON	DQN	4	3000	180.0	9.5	1.16	1.16	0.5	4.0	8.0	Q2
TLV707085DQNT	X2SON	DQN	4	250	180.0	9.5	1.16	1.16	0.5	4.0	8.0	Q2
TLV70710DQNR	X2SON	DQN	4	3000	180.0	8.4	1.16	1.16	0.63	4.0	8.0	Q2
TLV70710DQNR	X2SON	DQN	4	3000	180.0	9.5	1.16	1.16	0.5	4.0	8.0	Q2
TLV70710DQNT	X2SON	DQN	4	250	180.0	9.5	1.16	1.16	0.5	4.0	8.0	Q2
TLV70710DQNT	X2SON	DQN	4	250	180.0	8.4	1.16	1.16	0.63	4.0	8.0	Q2
TLV70710PDQNR	X2SON	DQN	4	3000	180.0	8.4	1.16	1.16	0.63	4.0	8.0	Q2
TLV70710PDQNR	X2SON	DQN	4	3000	180.0	9.5	1.16	1.16	0.5	4.0	8.0	Q2
TLV70710PDQNT	X2SON	DQN	4	250	180.0	8.4	1.16	1.16	0.63	4.0	8.0	Q2
TLV70710PDQNT	X2SON	DQN	4	250	180.0	9.5	1.16	1.16	0.5	4.0	8.0	Q2
TLV707115DQNR	X2SON	DQN	4	3000	180.0	8.4	1.16	1.16	0.63	4.0	8.0	Q2
TLV707115DQNR	X2SON	DQN	4	3000	180.0	9.5	1.16	1.16	0.5	4.0	8.0	Q2
TLV707115DQNT	X2SON	DQN	4	250	180.0	9.5	1.16	1.16	0.5	4.0	8.0	Q2
TLV707115DQNT	X2SON	DQN	4	250	180.0	8.4	1.16	1.16	0.63	4.0	8.0	Q2
TLV70711PDQNR	X2SON	DQN	4	3000	180.0	9.5	1.16	1.16	0.5	4.0	8.0	Q2
TLV70711PDQNT	X2SON	DQN	4	250	180.0	9.5	1.16	1.16	0.5	4.0	8.0	Q2

Device	Package Type	Package Drawing	Pins	SPQ	Reel Diameter (mm)	Reel Width W1 (mm)	A0 (mm)	B0 (mm)	K0 (mm)	P1 (mm)	W (mm)	Pin1 Quadrant
TLV70712PDQNR	X2SON	DQN	4	3000	180.0	8.4	1.16	1.16	0.5	4.0	8.0	Q2
TLV70712PDQNT	X2SON	DQN	4	250	180.0	8.4	1.16	1.16	0.5	4.0	8.0	Q2
TLV707135DQNR	X2SON	DQN	4	3000	180.0	9.5	1.16	1.16	0.5	4.0	8.0	Q2
TLV707135DQNT	X2SON	DQN	4	250	180.0	9.5	1.16	1.16	0.5	4.0	8.0	Q2
TLV70715PDQNR	X2SON	DQN	4	3000	180.0	9.5	1.16	1.16	0.5	4.0	8.0	Q2
TLV70715PDQNR	X2SON	DQN	4	3000	180.0	8.4	1.16	1.16	0.63	4.0	8.0	Q2
TLV70715PDQNT	X2SON	DQN	4	250	180.0	8.4	1.16	1.16	0.63	4.0	8.0	Q2
TLV70715PDQNT	X2SON	DQN	4	250	180.0	9.5	1.16	1.16	0.5	4.0	8.0	Q2
TLV70717DQNR	X2SON	DQN	4	3000	180.0	9.5	1.16	1.16	0.5	4.0	8.0	Q2
TLV70717DQNT	X2SON	DQN	4	250	180.0	9.5	1.16	1.16	0.5	4.0	8.0	Q2
TLV707185DQNR	X2SON	DQN	4	3000	180.0	9.5	1.16	1.16	0.5	4.0	8.0	Q2
TLV707185DQNR	X2SON	DQN	4	3000	180.0	8.4	1.16	1.16	0.63	4.0	8.0	Q2
TLV707185DQNT	X2SON	DQN	4	250	180.0	9.5	1.16	1.16	0.5	4.0	8.0	Q2
TLV707185DQNT	X2SON	DQN	4	250	180.0	8.4	1.16	1.16	0.63	4.0	8.0	Q2
TLV707185PDQNR	X2SON	DQN	4	3000	180.0	8.4	1.16	1.16	0.63	4.0	8.0	Q2
TLV707185PDQNR	X2SON	DQN	4	3000	180.0	9.5	1.16	1.16	0.5	4.0	8.0	Q2
TLV707185PDQNT	X2SON	DQN	4	250	180.0	8.4	1.16	1.16	0.63	4.0	8.0	Q2
TLV707185PDQNT	X2SON	DQN	4	250	180.0	9.5	1.16	1.16	0.5	4.0	8.0	Q2
TLV70718DQNR	X2SON	DQN	4	3000	180.0	9.5	1.16	1.16	0.5	4.0	8.0	Q2
TLV70718DQNR	X2SON	DQN	4	3000	180.0	8.4	1.16	1.16	0.63	4.0	8.0	Q2
TLV70718DQNT	X2SON	DQN	4	250	180.0	9.5	1.16	1.16	0.5	4.0	8.0	Q2
TLV70718DQNT	X2SON	DQN	4	250	180.0	8.4	1.16	1.16	0.63	4.0	8.0	Q2
TLV70718PDQNR	X2SON	DQN	4	3000	180.0	8.4	1.16	1.16	0.5	4.0	8.0	Q2
TLV70718PDQNT	X2SON	DQN	4	250	180.0	8.4	1.16	1.16	0.5	4.0	8.0	Q2
TLV70719PDQNR	X2SON	DQN	4	3000	180.0	8.4	1.16	1.16	0.5	4.0	8.0	Q2
TLV70719PDQNT	X2SON	DQN	4	250	180.0	8.4	1.16	1.16	0.5	4.0	8.0	Q2
TLV70725DQNR	X2SON	DQN	4	3000	180.0	9.5	1.16	1.16	0.5	4.0	8.0	Q2
TLV70725DQNT	X2SON	DQN	4	250	180.0	9.5	1.16	1.16	0.5	4.0	8.0	Q2
TLV70725PDQNR	X2SON	DQN	4	3000	180.0	8.4	1.16	1.16	0.5	4.0	8.0	Q2
TLV70725PDQNT	X2SON	DQN	4	250	180.0	8.4	1.16	1.16	0.5	4.0	8.0	Q2
TLV70726DQNR	X2SON	DQN	4	3000	180.0	9.5	1.16	1.16	0.5	4.0	8.0	Q2
TLV70726DQNR	X2SON	DQN	4	3000	180.0	8.4	1.16	1.16	0.63	4.0	8.0	Q2
TLV70726DQNT	X2SON	DQN	4	250	180.0	9.5	1.16	1.16	0.5	4.0	8.0	Q2
TLV70726DQNT	X2SON	DQN	4	250	180.0	8.4	1.16	1.16	0.63	4.0	8.0	Q2
TLV70726PDQNR	X2SON	DQN	4	3000	180.0	9.5	1.16	1.16	0.5	4.0	8.0	Q2
TLV70726PDQNR	X2SON	DQN	4	3000	180.0	8.4	1.16	1.16	0.63	4.0	8.0	Q2
TLV70726PDQNT	X2SON	DQN	4	250	180.0	9.5	1.16	1.16	0.5	4.0	8.0	Q2
TLV70726PDQNT	X2SON	DQN	4	250	180.0	8.4	1.16	1.16	0.63	4.0	8.0	Q2
TLV70727PDQNR	X2SON	DQN	4	3000	180.0	8.4	1.16	1.16	0.5	4.0	8.0	Q2
TLV70727PDQNT	X2SON	DQN	4	250	180.0	8.4	1.16	1.16	0.5	4.0	8.0	Q2
TLV707285DQNR	X2SON	DQN	4	3000	180.0	8.4	1.16	1.16	0.5	4.0	8.0	Q2

Device	Package Type	Package Drawing	Pins	SPQ	Reel Diameter (mm)	Reel Width W1 (mm)	A0 (mm)	B0 (mm)	K0 (mm)	P1 (mm)	W (mm)	Pin1 Quadrant
TLV707285DQNT	X2SON	DQN	4	250	180.0	8.4	1.16	1.16	0.5	4.0	8.0	Q2
TLV707285PDQNR	X2SON	DQN	4	3000	180.0	8.4	1.16	1.16	0.5	4.0	8.0	Q2
TLV707285PDQNT	X2SON	DQN	4	250	180.0	8.4	1.16	1.16	0.5	4.0	8.0	Q2
TLV70728PDQNR	X2SON	DQN	4	3000	180.0	9.5	1.16	1.16	0.5	4.0	8.0	Q2
TLV70728PDQNR	X2SON	DQN	4	3000	180.0	8.4	1.16	1.16	0.63	4.0	8.0	Q2
TLV70728PDQNT	X2SON	DQN	4	250	180.0	8.4	1.16	1.16	0.63	4.0	8.0	Q2
TLV70728PDQNT	X2SON	DQN	4	250	180.0	9.5	1.16	1.16	0.5	4.0	8.0	Q2
TLV70729DQNR	X2SON	DQN	4	3000	180.0	8.4	1.16	1.16	0.63	4.0	8.0	Q2
TLV70729DQNR	X2SON	DQN	4	3000	180.0	9.5	1.16	1.16	0.5	4.0	8.0	Q2
TLV70729DQNT	X2SON	DQN	4	250	180.0	9.5	1.16	1.16	0.5	4.0	8.0	Q2
TLV70729DQNT	X2SON	DQN	4	250	180.0	8.4	1.16	1.16	0.63	4.0	8.0	Q2
TLV70729PDQNR	X2SON	DQN	4	3000	180.0	9.5	1.16	1.16	0.5	4.0	8.0	Q2
TLV70729PDQNR	X2SON	DQN	4	3000	180.0	8.4	1.16	1.16	0.63	4.0	8.0	Q2
TLV70729PDQNT	X2SON	DQN	4	250	180.0	9.5	1.16	1.16	0.5	4.0	8.0	Q2
TLV70729PDQNT	X2SON	DQN	4	250	180.0	8.4	1.16	1.16	0.63	4.0	8.0	Q2
TLV70730DQNR	X2SON	DQN	4	3000	180.0	9.5	1.16	1.16	0.5	4.0	8.0	Q2
TLV70730DQNR	X2SON	DQN	4	3000	180.0	8.4	1.16	1.16	0.63	4.0	8.0	Q2
TLV70730DQNT	X2SON	DQN	4	250	180.0	8.4	1.16	1.16	0.63	4.0	8.0	Q2
TLV70730DQNT	X2SON	DQN	4	250	180.0	9.5	1.16	1.16	0.5	4.0	8.0	Q2
TLV70730PDQNR	X2SON	DQN	4	3000	180.0	8.4	1.16	1.16	0.63	4.0	8.0	Q2
TLV70730PDQNR	X2SON	DQN	4	3000	180.0	9.5	1.16	1.16	0.5	4.0	8.0	Q2
TLV70730PDQNT	X2SON	DQN	4	250	180.0	8.4	1.16	1.16	0.63	4.0	8.0	Q2
TLV70730PDQNT	X2SON	DQN	4	250	180.0	9.5	1.16	1.16	0.5	4.0	8.0	Q2
TLV70731DQNR	X2SON	DQN	4	3000	180.0	9.5	1.16	1.16	0.5	4.0	8.0	Q2
TLV70731DQNT	X2SON	DQN	4	250	180.0	9.5	1.16	1.16	0.5	4.0	8.0	Q2
TLV70732DQNR	X2SON	DQN	4	3000	180.0	9.5	1.16	1.16	0.5	4.0	8.0	Q2
TLV70732DQNR	X2SON	DQN	4	3000	180.0	8.4	1.16	1.16	0.5	4.0	8.0	Q2
TLV70732DQNT	X2SON	DQN	4	250	180.0	8.4	1.16	1.16	0.5	4.0	8.0	Q2
TLV707335DQNR	X2SON	DQN	4	3000	180.0	9.5	1.16	1.16	0.5	4.0	8.0	Q2
TLV707335DQNT	X2SON	DQN	4	250	180.0	9.5	1.16	1.16	0.5	4.0	8.0	Q2
TLV70733DQNR	X2SON	DQN	4	3000	180.0	9.5	1.16	1.16	0.5	4.0	8.0	Q2
TLV70733DQNR1	X2SON	DQN	4	3000	180.0	9.5	1.16	1.16	0.5	2.0	8.0	Q1
TLV70733DQNT	X2SON	DQN	4	250	180.0	9.5	1.16	1.16	0.5	4.0	8.0	Q2
TLV70733PDQNR	X2SON	DQN	4	3000	180.0	9.5	1.16	1.16	0.5	4.0	8.0	Q2
TLV70733PDQNR	X2SON	DQN	4	3000	180.0	8.4	1.16	1.16	0.63	4.0	8.0	Q2
TLV70733PDQNT	X2SON	DQN	4	250	180.0	8.4	1.16	1.16	0.63	4.0	8.0	Q2
TLV70733PDQNT	X2SON	DQN	4	250	180.0	9.5	1.16	1.16	0.5	4.0	8.0	Q2
TLV70734DQNR	X2SON	DQN	4	3000	180.0	8.4	1.16	1.16	0.63	4.0	8.0	Q2
TLV70734DQNR	X2SON	DQN	4	3000	180.0	9.5	1.16	1.16	0.5	4.0	8.0	Q2
TLV70734DQNT	X2SON	DQN	4	250	180.0	8.4	1.16	1.16	0.63	4.0	8.0	Q2
TLV70734DQNT	X2SON	DQN	4	250	180.0	9.5	1.16	1.16	0.5	4.0	8.0	Q2

Device	Package Type	Package Drawing	Pins	SPQ	Reel Diameter (mm)	Reel Width W1 (mm)	A0 (mm)	B0 (mm)	K0 (mm)	P1 (mm)	W (mm)	Pin1 Quadrant
TLV70734PDQNR	X2SON	DQN	4	3000	180.0	9.5	1.16	1.16	0.5	4.0	8.0	Q2
TLV70734PDQNT	X2SON	DQN	4	250	180.0	9.5	1.16	1.16	0.5	4.0	8.0	Q2
TLV70736DQNR	X2SON	DQN	4	3000	180.0	8.4	1.16	1.16	0.63	4.0	8.0	Q2
TLV70736DQNR	X2SON	DQN	4	3000	180.0	9.5	1.16	1.16	0.5	4.0	8.0	Q2
TLV70736DQNT	X2SON	DQN	4	250	180.0	9.5	1.16	1.16	0.5	4.0	8.0	Q2
TLV70736DQNT	X2SON	DQN	4	250	180.0	8.4	1.16	1.16	0.63	4.0	8.0	Q2
TLV70736PDQNR	X2SON	DQN	4	3000	180.0	8.4	1.16	1.16	0.5	4.0	8.0	Q2
TLV70736PDQNT	X2SON	DQN	4	250	180.0	8.4	1.16	1.16	0.5	4.0	8.0	Q2

## TAPE AND REEL BOX DIMENSIONS



\*All dimensions are nominal

Device	Package Type	Package Drawing	Pins	SPQ	Length (mm)	Width (mm)	Height (mm)
TLV707085DQNR	X2SON	DQN	4	3000	184.0	184.0	19.0
TLV707085DQNT	X2SON	DQN	4	250	184.0	184.0	19.0
TLV70710DQNR	X2SON	DQN	4	3000	183.0	183.0	20.0
TLV70710DQNR	X2SON	DQN	4	3000	184.0	184.0	19.0
TLV70710DQNT	X2SON	DQN	4	250	184.0	184.0	19.0
TLV70710DQNT	X2SON	DQN	4	250	183.0	183.0	20.0
TLV70710PDQNR	X2SON	DQN	4	3000	183.0	183.0	20.0
TLV70710PDQNR	X2SON	DQN	4	3000	184.0	184.0	19.0
TLV70710PDQNT	X2SON	DQN	4	250	183.0	183.0	20.0
TLV70710PDQNT	X2SON	DQN	4	250	184.0	184.0	19.0
TLV707115DQNR	X2SON	DQN	4	3000	183.0	183.0	20.0
TLV707115DQNR	X2SON	DQN	4	3000	184.0	184.0	19.0
TLV707115DQNT	X2SON	DQN	4	250	184.0	184.0	19.0
TLV707115DQNT	X2SON	DQN	4	250	183.0	183.0	20.0
TLV70711PDQNR	X2SON	DQN	4	3000	184.0	184.0	19.0
TLV70711PDQNT	X2SON	DQN	4	250	184.0	184.0	19.0
TLV70712PDQNR	X2SON	DQN	4	3000	210.0	185.0	35.0
TLV70712PDQNT	X2SON	DQN	4	250	210.0	185.0	35.0

Device	Package Type	Package Drawing	Pins	SPQ	Length (mm)	Width (mm)	Height (mm)
TLV707135DQNR	X2SON	DQN	4	3000	184.0	184.0	19.0
TLV707135DQNT	X2SON	DQN	4	250	184.0	184.0	19.0
TLV70715PDQNR	X2SON	DQN	4	3000	184.0	184.0	19.0
TLV70715PDQNR	X2SON	DQN	4	3000	183.0	183.0	20.0
TLV70715PDQNT	X2SON	DQN	4	250	183.0	183.0	20.0
TLV70715PDQNT	X2SON	DQN	4	250	184.0	184.0	19.0
TLV70717DQNR	X2SON	DQN	4	3000	184.0	184.0	19.0
TLV70717DQNT	X2SON	DQN	4	250	184.0	184.0	19.0
TLV707185DQNR	X2SON	DQN	4	3000	184.0	184.0	19.0
TLV707185DQNR	X2SON	DQN	4	3000	183.0	183.0	20.0
TLV707185DQNT	X2SON	DQN	4	250	184.0	184.0	19.0
TLV707185DQNT	X2SON	DQN	4	250	183.0	183.0	20.0
TLV707185PDQNR	X2SON	DQN	4	3000	183.0	183.0	20.0
TLV707185PDQNR	X2SON	DQN	4	3000	184.0	184.0	19.0
TLV707185PDQNT	X2SON	DQN	4	250	183.0	183.0	20.0
TLV707185PDQNT	X2SON	DQN	4	250	184.0	184.0	19.0
TLV70718DQNR	X2SON	DQN	4	3000	184.0	184.0	19.0
TLV70718DQNR	X2SON	DQN	4	3000	183.0	183.0	20.0
TLV70718DQNT	X2SON	DQN	4	250	184.0	184.0	19.0
TLV70718DQNT	X2SON	DQN	4	250	183.0	183.0	20.0
TLV70718PDQNR	X2SON	DQN	4	3000	210.0	185.0	35.0
TLV70718PDQNT	X2SON	DQN	4	250	210.0	185.0	35.0
TLV70719PDQNR	X2SON	DQN	4	3000	210.0	185.0	35.0
TLV70719PDQNT	X2SON	DQN	4	250	210.0	185.0	35.0
TLV70725DQNR	X2SON	DQN	4	3000	184.0	184.0	19.0
TLV70725DQNT	X2SON	DQN	4	250	184.0	184.0	19.0
TLV70725PDQNR	X2SON	DQN	4	3000	210.0	185.0	35.0
TLV70725PDQNT	X2SON	DQN	4	250	210.0	185.0	35.0
TLV70726DQNR	X2SON	DQN	4	3000	184.0	184.0	19.0
TLV70726DQNR	X2SON	DQN	4	3000	183.0	183.0	20.0
TLV70726DQNT	X2SON	DQN	4	250	184.0	184.0	19.0
TLV70726DQNT	X2SON	DQN	4	250	183.0	183.0	20.0
TLV70726PDQNR	X2SON	DQN	4	3000	184.0	184.0	19.0
TLV70726PDQNR	X2SON	DQN	4	3000	183.0	183.0	20.0
TLV70726PDQNT	X2SON	DQN	4	250	184.0	184.0	19.0
TLV70726PDQNT	X2SON	DQN	4	250	183.0	183.0	20.0
TLV70727PDQNR	X2SON	DQN	4	3000	210.0	185.0	35.0
TLV70727PDQNT	X2SON	DQN	4	250	210.0	185.0	35.0
TLV707285DQNR	X2SON	DQN	4	3000	210.0	185.0	35.0
TLV707285DQNT	X2SON	DQN	4	250	210.0	185.0	35.0
TLV707285PDQNR	X2SON	DQN	4	3000	210.0	185.0	35.0
TLV707285PDQNT	X2SON	DQN	4	250	210.0	185.0	35.0
TLV70728PDQNR	X2SON	DQN	4	3000	184.0	184.0	19.0

Device	Package Type	Package Drawing	Pins	SPQ	Length (mm)	Width (mm)	Height (mm)
TLV70728PDQNR	X2SON	DQN	4	3000	183.0	183.0	20.0
TLV70728PDQNT	X2SON	DQN	4	250	183.0	183.0	20.0
TLV70728PDQNT	X2SON	DQN	4	250	184.0	184.0	19.0
TLV70729DQNR	X2SON	DQN	4	3000	183.0	183.0	20.0
TLV70729DQNR	X2SON	DQN	4	3000	184.0	184.0	19.0
TLV70729DQNT	X2SON	DQN	4	250	184.0	184.0	19.0
TLV70729DQNT	X2SON	DQN	4	250	183.0	183.0	20.0
TLV70729PDQNR	X2SON	DQN	4	3000	184.0	184.0	19.0
TLV70729PDQNR	X2SON	DQN	4	3000	183.0	183.0	20.0
TLV70729PDQNT	X2SON	DQN	4	250	184.0	184.0	19.0
TLV70729PDQNT	X2SON	DQN	4	250	183.0	183.0	20.0
TLV70730DQNR	X2SON	DQN	4	3000	184.0	184.0	19.0
TLV70730DQNR	X2SON	DQN	4	3000	183.0	183.0	20.0
TLV70730DQNT	X2SON	DQN	4	250	183.0	183.0	20.0
TLV70730DQNT	X2SON	DQN	4	250	184.0	184.0	19.0
TLV70730PDQNR	X2SON	DQN	4	3000	183.0	183.0	20.0
TLV70730PDQNR	X2SON	DQN	4	3000	184.0	184.0	19.0
TLV70730PDQNT	X2SON	DQN	4	250	183.0	183.0	20.0
TLV70730PDQNT	X2SON	DQN	4	250	184.0	184.0	19.0
TLV70731DQNR	X2SON	DQN	4	3000	184.0	184.0	19.0
TLV70731DQNT	X2SON	DQN	4	250	184.0	184.0	19.0
TLV70732DQNR	X2SON	DQN	4	3000	184.0	184.0	19.0
TLV70732DQNR	X2SON	DQN	4	3000	210.0	185.0	35.0
TLV70732DQNT	X2SON	DQN	4	250	210.0	185.0	35.0
TLV707335DQNR	X2SON	DQN	4	3000	184.0	184.0	19.0
TLV707335DQNT	X2SON	DQN	4	250	184.0	184.0	19.0
TLV70733DQNR	X2SON	DQN	4	3000	184.0	184.0	19.0
TLV70733DQNR1	X2SON	DQN	4	3000	184.0	184.0	19.0
TLV70733DQNT	X2SON	DQN	4	250	184.0	184.0	19.0
TLV70733PDQNR	X2SON	DQN	4	3000	184.0	184.0	19.0
TLV70733PDQNR	X2SON	DQN	4	3000	183.0	183.0	20.0
TLV70733PDQNT	X2SON	DQN	4	250	183.0	183.0	20.0
TLV70733PDQNT	X2SON	DQN	4	250	184.0	184.0	19.0
TLV70734DQNR	X2SON	DQN	4	3000	183.0	183.0	20.0
TLV70734DQNR	X2SON	DQN	4	3000	184.0	184.0	19.0
TLV70734DQNT	X2SON	DQN	4	250	183.0	183.0	20.0
TLV70734DQNT	X2SON	DQN	4	250	184.0	184.0	19.0
TLV70734PDQNR	X2SON	DQN	4	3000	184.0	184.0	19.0
TLV70734PDQNT	X2SON	DQN	4	250	184.0	184.0	19.0
TLV70736DQNR	X2SON	DQN	4	3000	183.0	183.0	20.0
TLV70736DQNR	X2SON	DQN	4	3000	184.0	184.0	19.0
TLV70736DQNT	X2SON	DQN	4	250	184.0	184.0	19.0
TLV70736DQNT	X2SON	DQN	4	250	183.0	183.0	20.0

---

Device	Package Type	Package Drawing	Pins	SPQ	Length (mm)	Width (mm)	Height (mm)
TLV70736PDQNR	X2SON	DQN	4	3000	210.0	185.0	35.0
TLV70736PDQNT	X2SON	DQN	4	250	210.0	185.0	35.0



## GENERIC PACKAGE VIEW

DQN 4

**X2SON - 0.4 mm max height**

PLASTIC SMALL OUTLINE - NO LEAD



Images above are just a representation of the package family, actual package may vary.  
Refer to the product data sheet for package details.

4210367/F

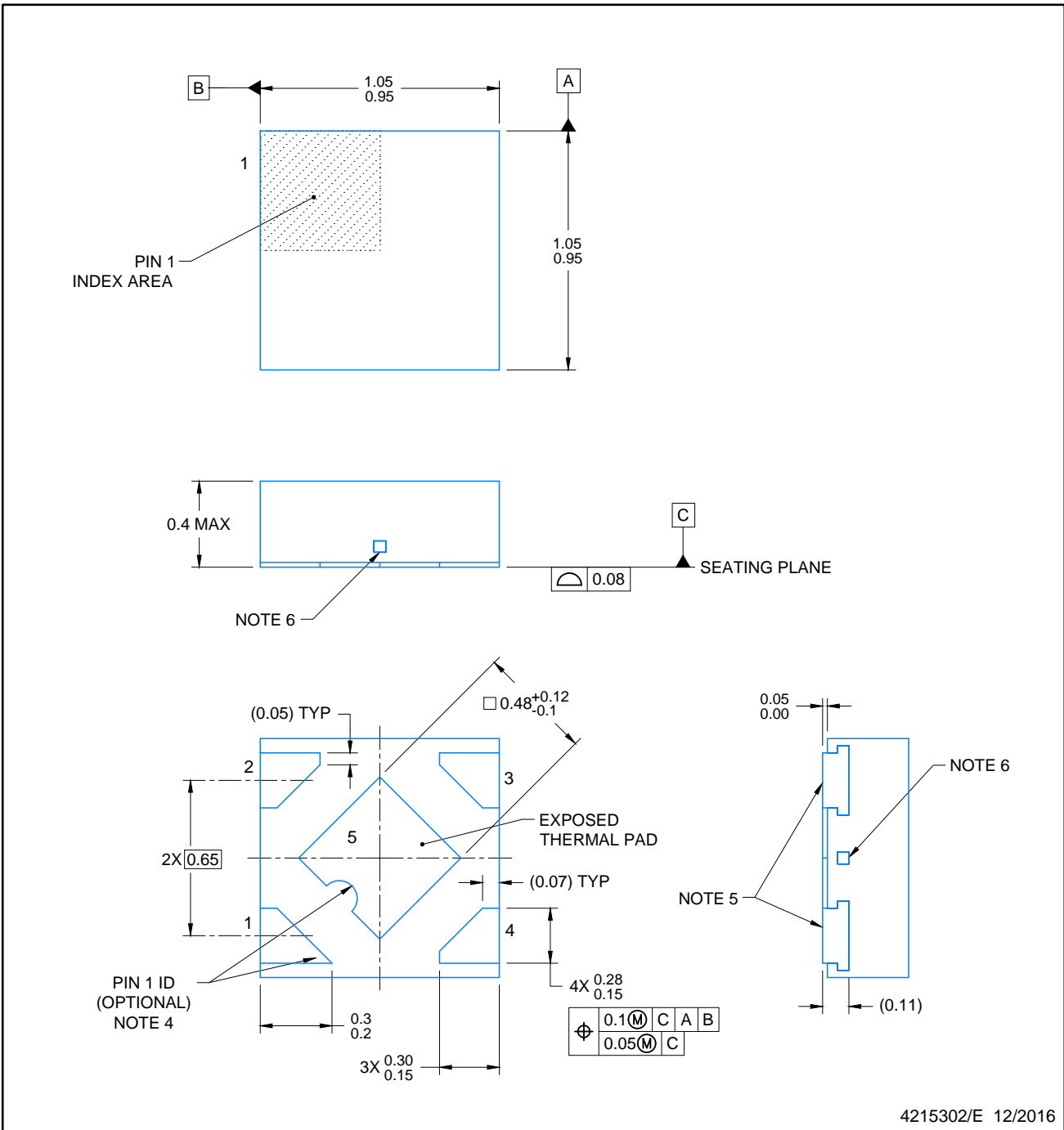

4215302/E 12/2016

NOTES:

1. All linear dimensions are in millimeters. Any dimensions in parenthesis are for reference only. Dimensioning and tolerancing per ASME Y14.5M.
2. This drawing is subject to change without notice.
3. The package thermal pad must be soldered to the printed circuit board for optimal thermal and mechanical performance.
4. Features may not exist. Recommend use of pin 1 marking on top of package for orientation purposes.
5. Shape of exposed side leads may differ.
6. Number and location of exposed tie bars may vary.

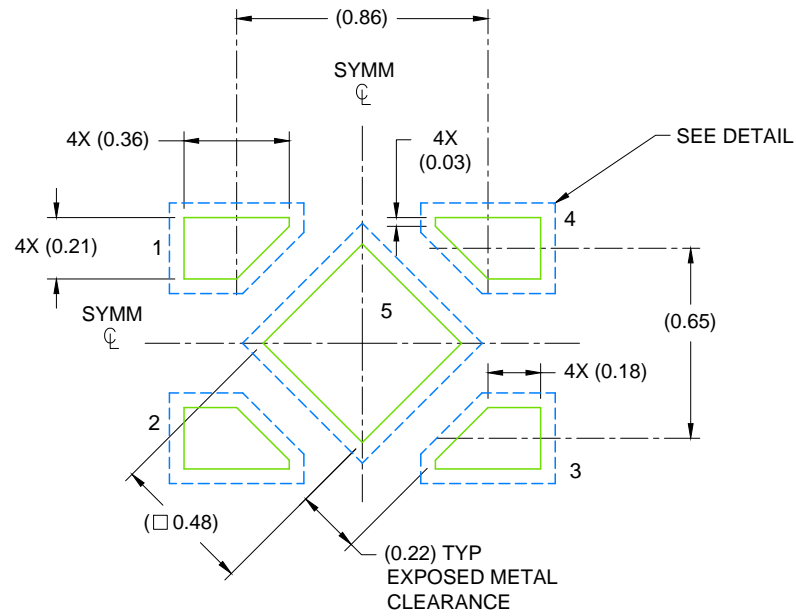

LAND PATTERN EXAMPLE  
SCALE: 40X

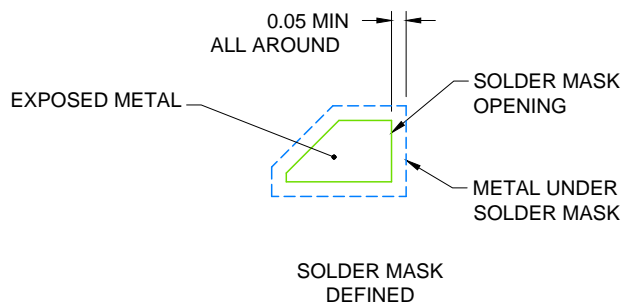

SOLDER MASK DETAIL

4215302/E 12/2016

NOTES: (continued)

7. This package is designed to be soldered to a thermal pad on the board. For more information, see Texas Instruments literature number SLUA271 ([www.ti.com/lit/sluea271](http://www.ti.com/lit/sluea271)).
8. If any vias are implemented, it is recommended that vias under paste be filled, plugged or tented.



SOLDER PASTE EXAMPLE  
 BASED ON 0.075 - 0.1mm THICK STENCIL  
 EXPOSED PAD  
 88% PRINTED SOLDER COVERAGE BY AREA  
 SCALE: 60X

4215302/E 12/2016

NOTES: (continued)

- 9. Laser cutting apertures with trapezoidal walls and rounded corners may offer better paste release. IPC-7525 may have alternate design recommendations.

## 重要声明和免责声明

TI“按原样”提供技术和可靠性数据（包括数据表）、设计资源（包括参考设计）、应用或其他设计建议、网络工具、安全信息和其他资源，不保证没有瑕疵且不做任何明示或暗示的担保，包括但不限于对适销性、某特定用途方面的适用性或不侵犯任何第三方知识产权的暗示担保。

这些资源可供使用 TI 产品进行设计的熟练开发人员使用。您将自行承担以下全部责任：(1) 针对您的应用选择合适的 TI 产品，(2) 设计、验证并测试您的应用，(3) 确保您的应用满足相应标准以及任何其他功能安全、信息安全、监管或其他要求。

这些资源如有变更，恕不另行通知。TI 授权您仅可将这些资源用于研发本资源所述的 TI 产品的应用。严禁对这些资源进行其他复制或展示。您无权使用任何其他 TI 知识产权或任何第三方知识产权。您应全额赔偿因在这些资源的使用中对 TI 及其代表造成的任何索赔、损害、成本、损失和债务，TI 对此概不负责。

TI 提供的产品受 [TI 的销售条款](#) 或 [ti.com](#) 上其他适用条款/TI 产品随附的其他适用条款的约束。TI 提供这些资源并不会扩展或以其他方式更改 TI 针对 TI 产品发布的适用的担保或担保免责声明。

TI 反对并拒绝您可能提出的任何其他或不同的条款。

邮寄地址：Texas Instruments, Post Office Box 655303, Dallas, Texas 75265

Copyright © 2022，德州仪器 (TI) 公司

## X-ON Electronics

Largest Supplier of Electrical and Electronic Components

*Click to view similar products for [LDO Voltage Regulators](#) category:*

*Click to view products by [Texas Instruments](#) manufacturer:*

Other Similar products are found below :

[AP7363-SP-13](#) [NCV8664CST33T3G](#) [L79M05TL-E](#) [AP7362-HA-7](#) [PT7M8202B12TA5EX](#) [TCR3DF185,LM\(CT](#) [TLF4949EJ](#)  
[NCP4687DH15T1G](#) [NCV8703MX30TCG](#) [LP2951CN](#) [NCV4269CPD50R2G](#) [AP7315-25W5-7](#) [NCV47411PAAJR2G](#) [AP2111H-1.2TRG1](#)  
[ZLDO1117QK50TC](#) [AZ1117ID-ADJTRG1](#) [NCV4263-2CPD50R2G](#) [NCP114BMX075TCG](#) [MC33269T-3.5G](#) [TLE4471GXT](#) [AP7315-33SA-](#)  
[7](#) [NCV4266-2CST33T3G](#) [NCP715SQ15T2G](#) [NCV8623MN-50R2G](#) [NCV563SQ18T1G](#) [NCV8664CDT33RKG](#) [NCV4299CD250R2G](#)  
[NCP715MX30TBG](#) [NCV8702MX25TCG](#) [TLE7270-2E](#) [NCV562SQ25T1G](#) [AP2213D-3.3TRG1](#) [AP2202K-2.6TRE1](#)  
[NCV8170BMX300TCG](#) [NCV8152MX300180TCG](#) [NCP700CMT45TBG](#) [AP7315-33W5-7](#) [NCP154MX180300TAG](#) [AP2113AMTR-G1](#)  
[NJW4104U2-33A-TE1](#) [MP2013AGG-5-P](#) [NCV8775CDT50RKG](#) [NJM2878F3-45-TE1](#) [S-19214B00A-V5T2U7](#) [S-19214B50A-V5T2U7](#) [S-](#)  
[19213B50A-V5T2U7](#) [S-19214BC0A-E8T1U7\\*1](#) [S-19213B00A-V5T2U7](#) [S-19213B33A-V5T2U7](#) [S-19213BC0A-V5T2U7](#)