

# TLV716/P 采用 1.2mm x 1.2mm SON 封装的无电容、双通道、150mA 低压降稳压器

## 1 特性

- 无需输入或输出电容
- 浪涌电流控制
- 低串扰
- 精度：1.5% (–40°C 至 125°C)
- 输入电压范围：1.4V 至 5.5V
- 可提供介于 1V 至 3.3V 间的多种固定输出电压组合
- 折返电流保护
- 封装：1.2mm x 1.2mm 小外形尺寸无引线 (SON)-6 (DPQ)

## 2 应用

- 无线听筒、智能电话、平板电脑
- 机顶盒 (STB)，摄像机，调制解调器
- 便携式电池供电类产品

## 3 说明

TLV716 是双通道、无电容、150mA 低压降 (LDO) 稳压器系列器件，提供多种固定输出电压选项 (1V 至 3.3V 范围)。该系列器件的初始精度为 1%，整个温度范围内的精度为 1.5%。

TLV716 系列被设计成在具有或没有输入或输出电容器时保持稳定。移除输出电容器可实现极小的解决方案尺寸。TLV716P 系列提供一个有源下拉电路，可在需要使用输出电容的应用中使输出电压快速放电。

该器件还可在上电和使能期间控制浪涌电流。浪涌控制在器件启动期间为输出负载提供恒定电流进行充电，因此可降低输入电源或电池发生意外过流故障的风险。

TLV716 器件采用 1.2mm x 1.2mm SOT-6 封装，非常适用于空间受限类应用。

### 器件信息<sup>(1)</sup>

器件型号	封装	封装尺寸 (标称值)
TLV716	X2SON (6)	1.20mm x 1.20mm
TLV716P		

(1) 要了解所有可用封装，请见数据表末尾的可订购产品附录。

### 典型应用电路

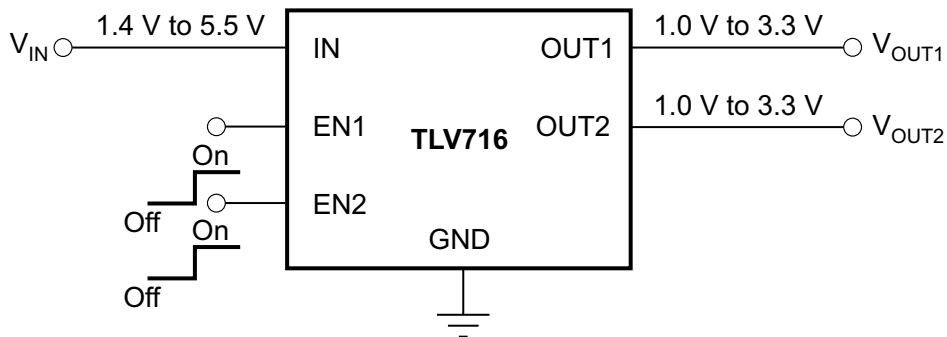

## 目录

<b>1</b>	<b>特性</b> .....	<b>1</b>	<b>8</b>	<b>Application and Implementation</b> .....	<b>12</b>
<b>2</b>	<b>应用</b> .....	<b>1</b>	8.1	Application Information.....	12
<b>3</b>	<b>说明</b> .....	<b>1</b>	8.2	Typical Application .....	12
<b>4</b>	<b>修订历史记录</b> .....	<b>2</b>	<b>9</b>	<b>Power Supply Recommendations</b> .....	<b>13</b>
<b>5</b>	<b>Pin Configuration and Functions</b> .....	<b>3</b>	<b>10</b>	<b>Layout</b> .....	<b>14</b>
<b>6</b>	<b>Specifications</b> .....	<b>4</b>	10.1	Layout Guidelines .....	14
6.1	Absolute Maximum Ratings .....	4	10.2	Layout Example .....	14
6.2	ESD Ratings.....	4	10.3	Thermal Considerations .....	14
6.3	Recommended Operating Conditions.....	4	10.4	Power Dissipation .....	14
6.4	Thermal Information .....	4	<b>11</b>	<b>器件和文档支持</b> .....	<b>16</b>
6.5	Electrical Characteristics.....	5	11.1	相关链接 .....	16
6.6	Typical Characteristics .....	6	11.2	社区资源 .....	16
<b>7</b>	<b>Detailed Description</b> .....	<b>10</b>	11.3	商标 .....	16
7.1	Overview .....	10	11.4	静电放电警告 .....	16
7.2	Functional Block Diagram .....	10	11.5	Glossary .....	16
7.3	Feature Description.....	11	<b>12</b>	<b>机械、封装和可订购信息</b> .....	<b>16</b>
7.4	Device Functional Modes.....	11			

## 4 修订历史记录

注：之前版本的页码可能与当前版本有所不同。

<b>Changes from Revision A (September 2013) to Revision B</b>	<b>Page</b>
• 已删除 标题中的 (LDO).....	1
• 已更改 精度要点 1% 至 1.5% 并添加了温度范围 (–40°C 至 125°C) .....	1

<b>Changes from Original (June 2013) to Revision A</b>	<b>Page</b>
• 已添加 ESD 额定值表, 特性 描述 部分, 器件功能模式, 应用和实施部分, 电源相关建议部分, 布局部分, 器件和文档支持部分以及机械、封装和可订购信息部分 .....	1
• 已更改 文档状态“产品预览”至“量产数据”; 通篇进行 pre-RTM 修改 .....	1
• Changed junction temperature range in second paragraph of Overview section .....	10

## 5 Pin Configuration and Functions

**DPQ Package  
6-Pin X2SON  
Top View**

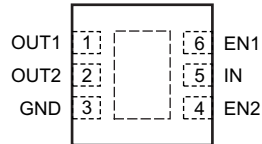

### Pin Functions

PIN		I/O	DESCRIPTION
NAME	NO.		
OUT1	1	O	Regulated output voltage pin. See the <a href="#">Input and Output Capacitor Requirements</a> section for more details.
OUT2	2	O	Regulated output voltage pin. See the <a href="#">Input and Output Capacitor Requirements</a> section for more details.
GND	3	—	Ground pin.
EN2	4	I	Enable pin for regulator 2. Driving EN2 over 0.9 V turns on regulator 2. Driving EN2 below 0.4 V places regulator 2 into shutdown mode.
IN	5	I	Input voltage pin. See the <a href="#">Input and Output Capacitor Requirements</a> section for more details.
EN1	6	I	Enable pin for regulator 1. Driving EN1 over 0.9 V turns on regulator 1. Driving EN1 below 0.4 V places regulator 1 into shutdown mode.
PAD	—	—	Connecting the thermal pad to the ground plane improves the thermal performance.

## 6 Specifications

### 6.1 Absolute Maximum Ratings

at  $T_J = -40^\circ\text{C}$  to  $125^\circ\text{C}$ , unless otherwise noted. <sup>(1)</sup>

		MIN	MAX	UNIT
Voltage <sup>(2)</sup>	IN	-0.3	6	V
	EN1, EN2	-0.3	$V_{IN} + 0.3$	V
	OUT1, OUT2	-0.3	$3.6$ or $V_{IN} + 0.3$	V
Current, OUT1, OUT2		-30	Internally limited	mA
Output short circuit duration		Indefinite		s
$T_J$	Operating junction temperature	-55	150	$^\circ\text{C}$
$T_{stg}$	Storage temperature	-55	150	$^\circ\text{C}$

- (1) Stresses beyond those listed under *Absolute Maximum Ratings* may cause permanent damage to the device. These are stress ratings only, which do not imply functional operation of the device at these or any other conditions beyond those indicated under *Recommended Operating Conditions*. Exposure to absolute-maximum-rated conditions for extended periods may affect device reliability.
- (2) All voltages are with respect to ground.

### 6.2 ESD Ratings

		VALUE	UNIT
$V_{(ESD)}$ Electrostatic discharge	Human body model (HBM), per ANSI/ESDA/JEDEC JS-001, all pins <sup>(1)</sup>	$\pm 2000$	V
	Charged device model (CDM), per JEDEC specification JESD22-C101, all pins <sup>(2)</sup>	$\pm 500$	

- (1) JEDEC document JEP155 states that 500-V HBM allows safe manufacturing with a standard ESD control process.
- (2) JEDEC document JEP157 states that 250-V CDM allows safe manufacturing with a standard ESD control process.

### 6.3 Recommended Operating Conditions

over operating junction temperature range (unless otherwise noted).

		MIN	NOM	MAX	UNIT
$V_{IN}$	Input voltage	1.4		5.5	V
$V_{EN}$	Enable range: $V_{EN1}$ , $V_{EN2}$	0		$V_{IN}$	V
$I_{OUT}$	Output current: $I_{OUT1}$ , $I_{OUT2}$	0		150	mA
$C_{IN}$	Input capacitor	0	1		$\mu\text{F}$
$C_{OUT}$	Output capacitor: $C_{OUT1}$ , $C_{OUT2}$	0	0.1	100	$\mu\text{F}$
$T_J$	Operating junction temperature range	-40		125	$^\circ\text{C}$

### 6.4 Thermal Information

THERMAL METRIC <sup>(1)</sup>		TLV716, TLV716P	UNIT
		DPQ (X2SON)	
		6 PINS	
$R_{\theta JA}$	Junction-to-ambient thermal resistance	149.3	$^\circ\text{C}/\text{W}$
$R_{\theta JC(top)}$	Junction-to-case (top) thermal resistance	93	$^\circ\text{C}/\text{W}$
$R_{\theta JB}$	Junction-to-board thermal resistance	110.1	$^\circ\text{C}/\text{W}$
$\Psi_{JT}$	Junction-to-top characterization parameter	3.4	$^\circ\text{C}/\text{W}$
$\Psi_{JB}$	Junction-to-board characterization parameter	114.9	$^\circ\text{C}/\text{W}$
$R_{\theta JC(bot)}$	Junction-to-case (bottom) thermal resistance	91	$^\circ\text{C}/\text{W}$

- (1) For more information about traditional and new thermal metrics, see the *Semiconductor and IC Package Thermal Metrics* application report, [SPRA953](#).

## 6.5 Electrical Characteristics

over operating temperature range of  $T_A = -40^\circ\text{C}$  to  $85^\circ\text{C}$ ,  $V_{IN} = V_{OUT(TYP)} + 0.5\text{ V}$  or  $2\text{ V}$  (whichever is greater),  $I_{OUT} = 1\text{ mA}$ ,  $V_{EN1} = V_{EN2} = 0.9\text{ V}$ , and  $C_{IN} = C_{OUT1} = C_{OUT2} = 1\text{ }\mu\text{F}$ , unless otherwise noted. Typical values are at  $T_J = 25^\circ\text{C}$

PARAMETER	TEST CONDITIONS	MIN	TYP	MAX	UNIT		
$V_{IN}$	Input voltage range	1.4		5.5	V		
$V_{OUT}$	Output voltage accuracy	$T_J = 25^\circ\text{C}$ , $V_{OUT} > 1.2\text{ V}$	-1%	0.33%	1%		
		$T_J = 25^\circ\text{C}$ , $V_{OUT} \leq 1.2\text{ V}$	-20		20	mV	
		$T_J = -40^\circ\text{C}$ to $85^\circ\text{C}$ , $V_{OUT} > 1.2\text{ V}$	-1.5%		1.5%		
		$T_J = -40^\circ\text{C}$ to $85^\circ\text{C}$ , $V_{OUT} \leq 1.2\text{ V}$	-50		50	mV	
$I_{OUT}$	Output current	Each channel			150	mA	
$\Delta V_{OUT} / \Delta V_{IN}$	Line regulation	$V_{OUT} + 0.5\text{ V} < V_{IN} \leq 5.5\text{ V}$			0.02	0.2	%/V
$\Delta V_{OUT} / \Delta I_{OUT}$	Load regulation	$1\text{ mA} < I_{OUT} < 150\text{ mA}$			0.07	0.2	mV/mA
$\Delta V_{OUT} / \Delta I_{OUT}$	Cross load regulation	$1\text{ mA} < I_{OUT} < 150\text{ mA}$			0.005	0.066	mV/mA
$V_{DO}$	Dropout voltage	$I_{OUT} = 150\text{ mA}$ , $1\text{ V} \leq V_{OUT} < 1.2\text{ V}$		0.78	1	V	
		$I_{OUT} = 150\text{ mA}$ , $1.2\text{ V} \leq V_{OUT} < 1.8\text{ V}$		0.6	0.9	V	
		$I_{OUT} = 150\text{ mA}$ , $1.8\text{ V} \leq V_{OUT} < 2.1\text{ V}$		0.35	0.575	V	
		$I_{OUT} = 150\text{ mA}$ , $2.1\text{ V} \leq V_{OUT} < 2.5\text{ V}$		0.29	0.48	V	
		$I_{OUT} = 150\text{ mA}$ , $2.5\text{ V} \leq V_{OUT} < 3\text{ V}$		0.23	0.45	V	
		$I_{OUT} = 150\text{ mA}$ , $3\text{ V} \leq V_{OUT} < 3.3\text{ V}$		0.21	0.42	V	
$V_{HI}$	Enable high voltage	0.9		$V_{IN}$	V		
$V_{LO}$	Enable low voltage	0		0.4	V		
$R_{PD}$	Output pulldown resistance	TLV716P only			120	$\Omega$	
$I_{CL}$	Output current limit	$V_{IN} = V_{OUT(TYP)} + 0.5\text{ V}$ or $2.1\text{ V}$ (whichever is greater)			160	500	mA
$I_{SC}$	Output short current limit	$V_{OUT} = 0\text{ V}$			40		mA
$I_{GND}$	Ground pin current	Per channel, $I_{OUT} = 0\text{ mA}$ , $V_{IN} = 5.5\text{ V}$			50	75	$\mu\text{A}$
$I_{SHUTDOWN}$	Shutdown current	Per channel, $V_{IN} = 5.5\text{ V}$ , $T_J = 25^\circ\text{C}$			0.1	1	$\mu\text{A}$
PSRR	Power-supply rejection ratio	$f = 100\text{ Hz}$ , $V_{OUT} = 2.8\text{ V}$ , $I_{OUT} = 30\text{ mA}$			80		dB
		$f = 10\text{ kHz}$ , $V_{OUT} = 2.8\text{ V}$ , $I_{OUT} = 30\text{ mA}$			46		dB
$V_N$	Output noise voltage	BW = 10 Hz to 100 kHz, $V_{OUT} = 1.8\text{ V}$ , $V_{IN} = 2.3\text{ V}$ , $I_{OUT} = 10\text{ mA}$			70		$\mu\text{V}_{RMS}$
$t_{STR}$	Start-up time <sup>(1)</sup>	$V_{OUT} = 1\text{ V}$ , $I_{OUT} = 150\text{ mA}$			170		$\mu\text{s}$
		$V_{OUT} = 3.3\text{ V}$ , $I_{OUT} = 150\text{ mA}$			900		$\mu\text{s}$
$T_{SD}$	Thermal shutdown temperature	Shutdown, temperature increasing			158		$^\circ\text{C}$
		Reset, temperature decreasing			140		$^\circ\text{C}$
$T_J$	Operating Junction Temperature				-40	125	$^\circ\text{C}$

(1) Start-up time = time from EN assertion to  $0.98 \times V_{OUT(NOM)}$ .

### 6.6 Typical Characteristics

Over operating temperature range of  $T_J = -40^{\circ}\text{C}$  to  $125^{\circ}\text{C}$ ,  $V_{IN} = V_{OUT(TYP)} + 0.5\text{ V}$  or  $2\text{ V}$  (whichever is greater),  $V_{EN1} = V_{EN2} = V_{IN}$ ,  $I_{OUT1} = I_{OUT2} = 10\text{ mA}$ ,  $C_{IN} = 1\text{ }\mu\text{F}$ ,  $C_{OUT1} = 1\text{ }\mu\text{F}$ , and  $C_{OUT2} = 1\text{ }\mu\text{F}$ , unless otherwise noted. Output current plots show typical performance with a single output current sweep. Typical values are at  $T_J = 25^{\circ}\text{C}$ .

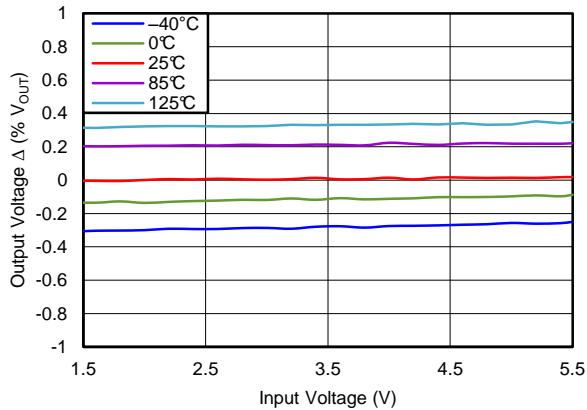

**Figure 1. Line Regulation**  
% $V_{OUT}$  Deviation vs  $V_{IN}$  ( $V_{OUT} = 1\text{ V}$ )

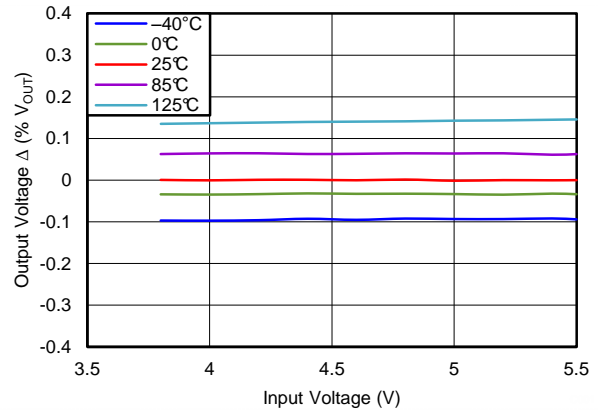

**Figure 2. Line Regulation**  
% $V_{OUT}$  Deviation vs  $V_{IN}$  ( $V_{OUT} = 3.3\text{ V}$ )

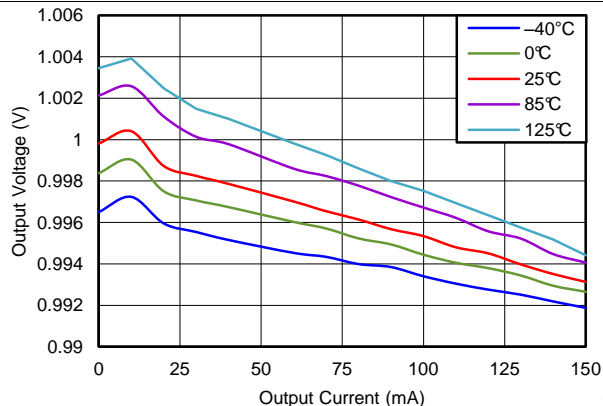

**Figure 3. Load Regulation**  
 $V_{OUT}$  vs  $I_{OUT}$  ( $V_{OUT} = 1\text{ V}$ )

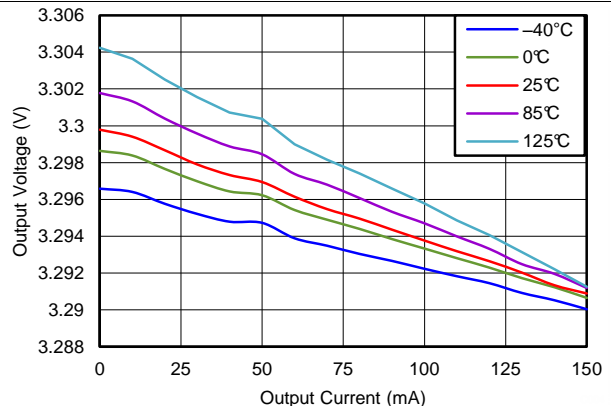

**Figure 4. Load Regulation**  
 $V_{OUT}$  vs  $I_{OUT}$  ( $V_{OUT} = 3.3\text{ V}$ )

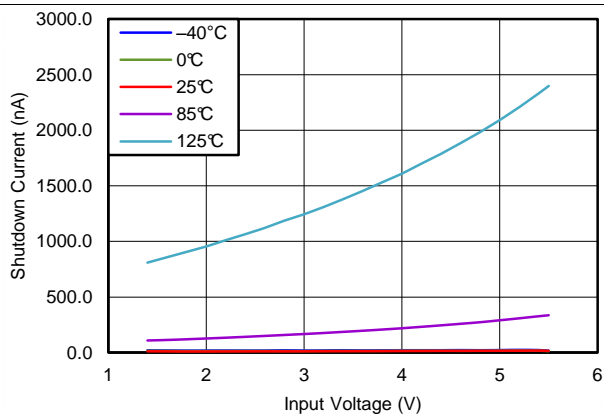

**Figure 5. Shutdown Current vs  $V_{IN}$**

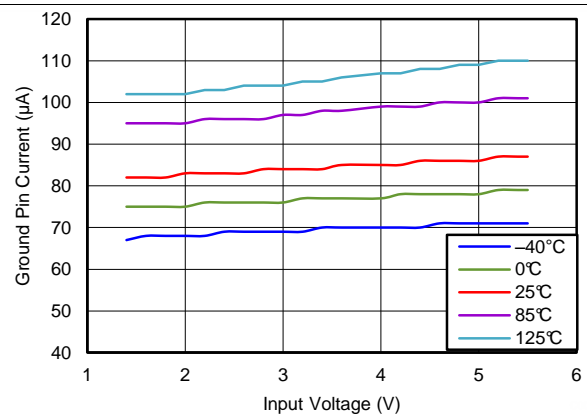

**Figure 6. Ground Pin Current vs  $V_{IN}$**

### Typical Characteristics (continued)

Over operating temperature range of  $T_J = -40^\circ\text{C}$  to  $125^\circ\text{C}$ ,  $V_{IN} = V_{OUT(TYP)} + 0.5\text{ V}$  or  $2\text{ V}$  (whichever is greater),  $V_{EN1} = V_{EN2} = V_{IN}$ ,  $I_{OUT1} = I_{OUT2} = 10\text{ mA}$ ,  $C_{IN} = 1\text{ }\mu\text{F}$ ,  $C_{OUT1} = 1\text{ }\mu\text{F}$ , and  $C_{OUT2} = 1\text{ }\mu\text{F}$ , unless otherwise noted. Output current plots show typical performance with a single output current sweep. Typical values are at  $T_J = 25^\circ\text{C}$ .

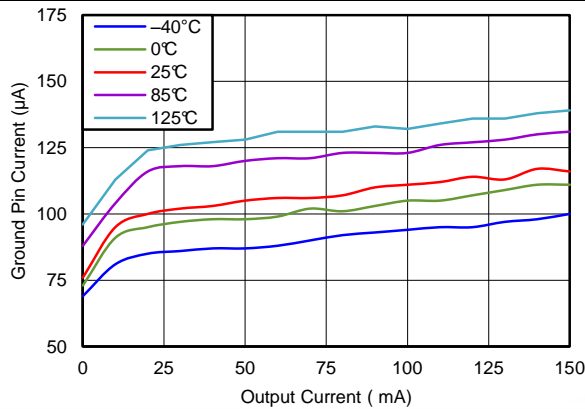

Figure 7. Ground Pin Current vs  $I_{OUT}$

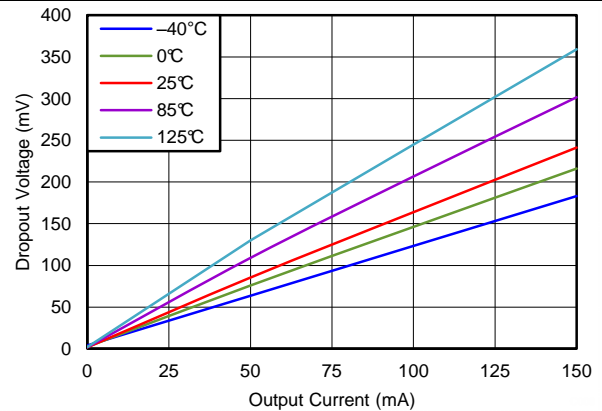

Figure 8. Dropout Voltage vs  $I_{OUT}$   
( $V_{OUT} = 3.3\text{ V}$ )

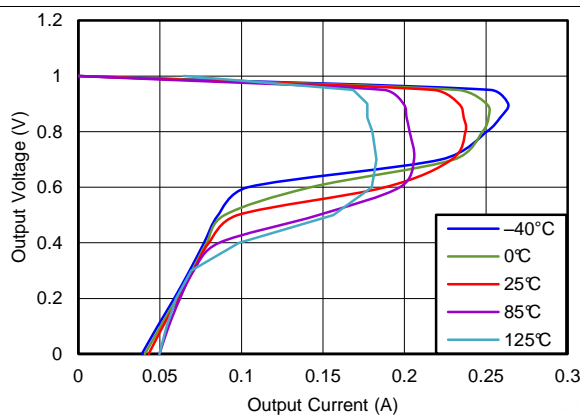

Figure 9. Output Voltage vs  
Output Current ( $V_{OUT} = 1\text{ V}$ )  
(Foldback Current Limit)

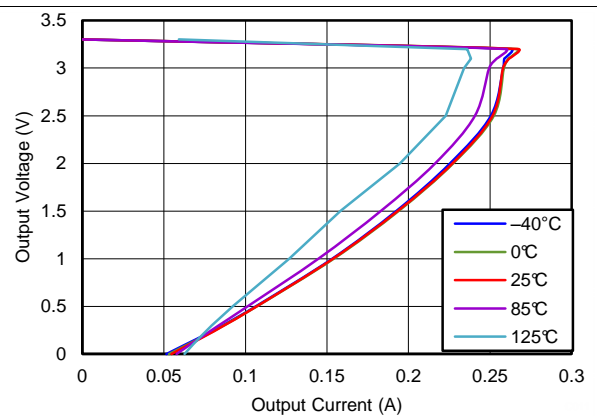

Figure 10. Output Voltage vs  
Output Current ( $V_{OUT} = 3.3\text{ V}$ )  
(Foldback Current Limit)

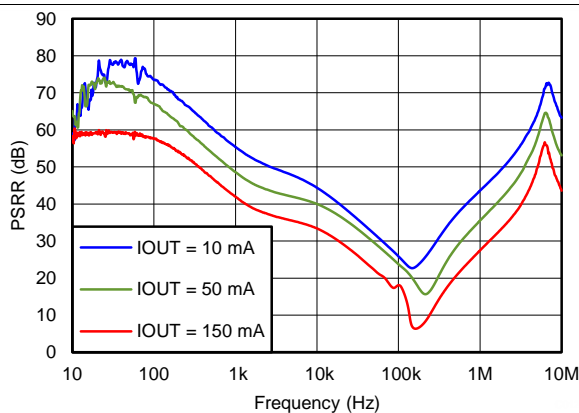

Figure 11. Power-Supply Rejection Ratio vs Frequency  
( $V_{OUT} = 3.3\text{ V}$ )

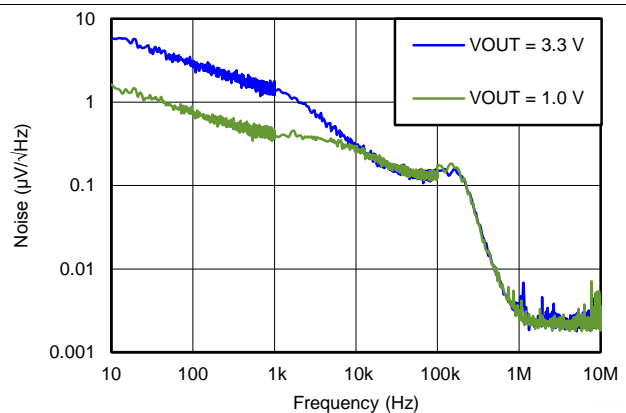
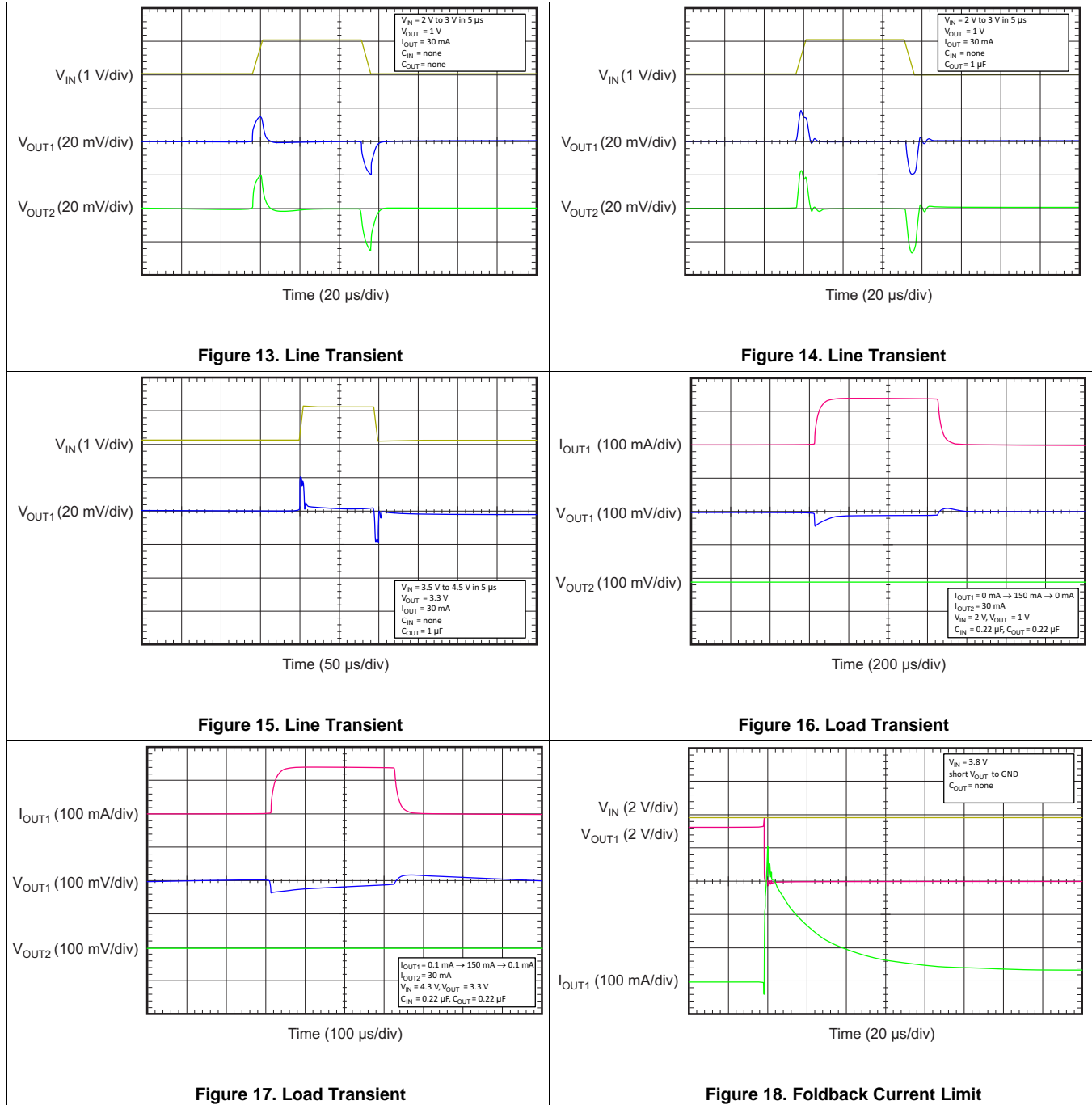

Figure 12. Output Spectral Noise Density

### Typical Characteristics (continued)

Over operating temperature range of  $T_J = -40^{\circ}\text{C}$  to  $125^{\circ}\text{C}$ ,  $V_{IN} = V_{OUT(TYP)} + 0.5\text{ V}$  or  $2\text{ V}$  (whichever is greater),  $V_{EN1} = V_{EN2} = V_{IN}$ ,  $I_{OUT1} = I_{OUT2} = 10\text{ mA}$ ,  $C_{IN} = 1\text{ }\mu\text{F}$ ,  $C_{OUT1} = 1\text{ }\mu\text{F}$ , and  $C_{OUT2} = 1\text{ }\mu\text{F}$ , unless otherwise noted. Output current plots show typical performance with a single output current sweep. Typical values are at  $T_J = 25^{\circ}\text{C}$ .





### Typical Characteristics (continued)

Over operating temperature range of  $T_J = -40^\circ\text{C}$  to  $125^\circ\text{C}$ ,  $V_{IN} = V_{OUT(TYP)} + 0.5\text{ V}$  or  $2\text{ V}$  (whichever is greater),  $V_{EN1} = V_{EN2} = V_{IN}$ ,  $I_{OUT1} = I_{OUT2} = 10\text{ mA}$ ,  $C_{IN} = 1\ \mu\text{F}$ ,  $C_{OUT1} = 1\ \mu\text{F}$ , and  $C_{OUT2} = 1\ \mu\text{F}$ , unless otherwise noted. Output current plots show typical performance with a single output current sweep. Typical values are at  $T_J = 25^\circ\text{C}$ .

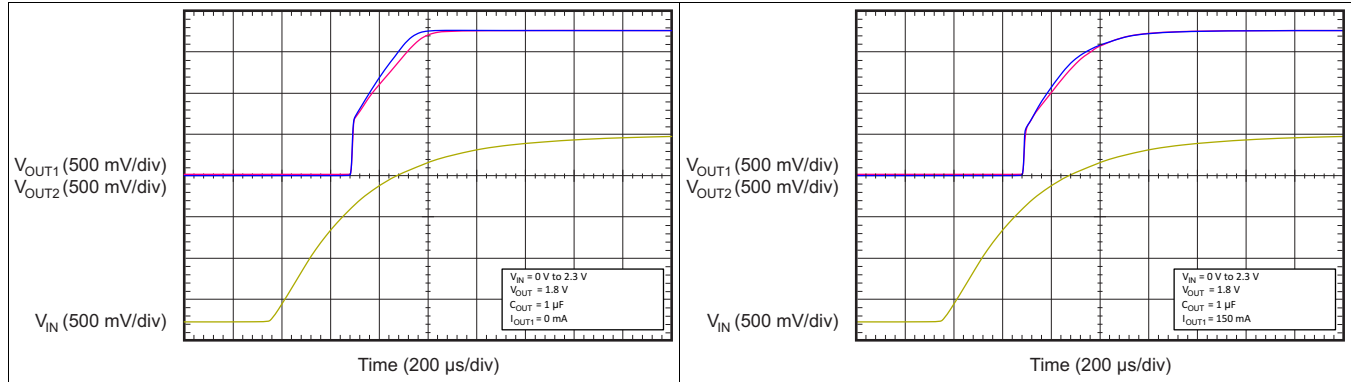

Figure 19. Start-Up

Figure 20. Start-Up

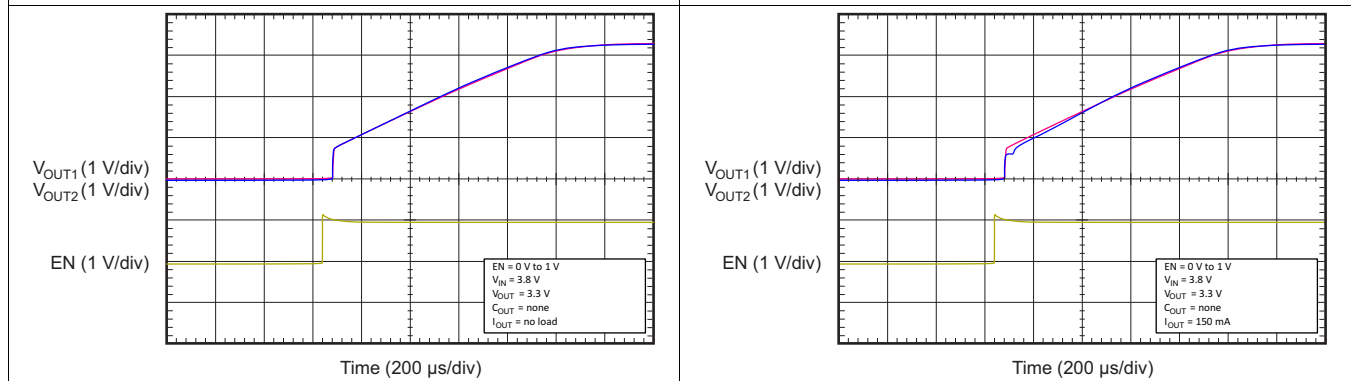

Figure 21. Start-Up With EN

Figure 22. Start-Up With EN

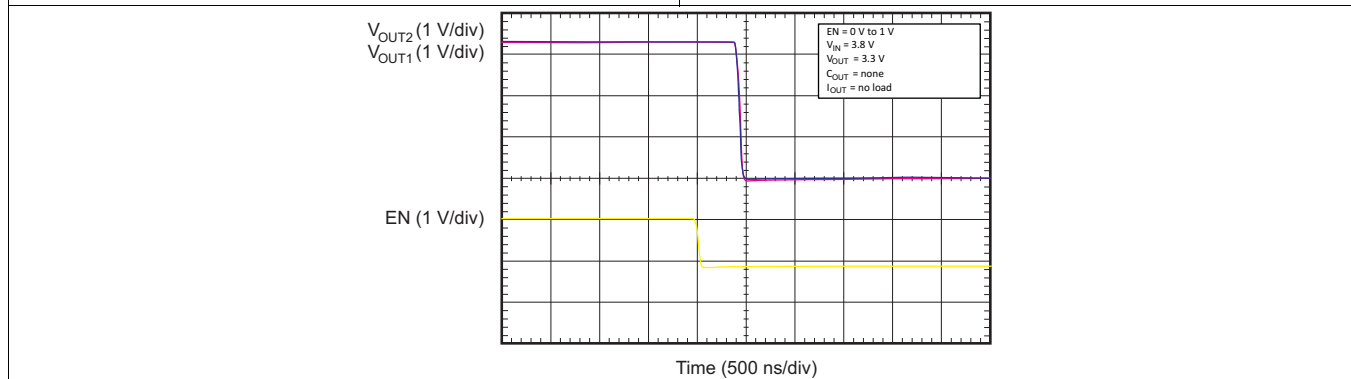

Figure 23. Shutdown With EN

## 7 Detailed Description

### 7.1 Overview

The TLV716 and TLV716P devices belong to a new family of next-generation of dual-value, low-dropout (LDO) regulators. These devices consume low quiescent current and deliver excellent line and load transient performance. These characteristics, combined with low noise, very good PSRR with little ( $V_{IN} - V_{OUT}$ ) headroom, make this family of devices ideal for RF portable applications.

This family of regulators offers current limit and thermal protection. Device operating junction temperature is  $-40^{\circ}\text{C}$  to  $125^{\circ}\text{C}$ .

### 7.2 Functional Block Diagram

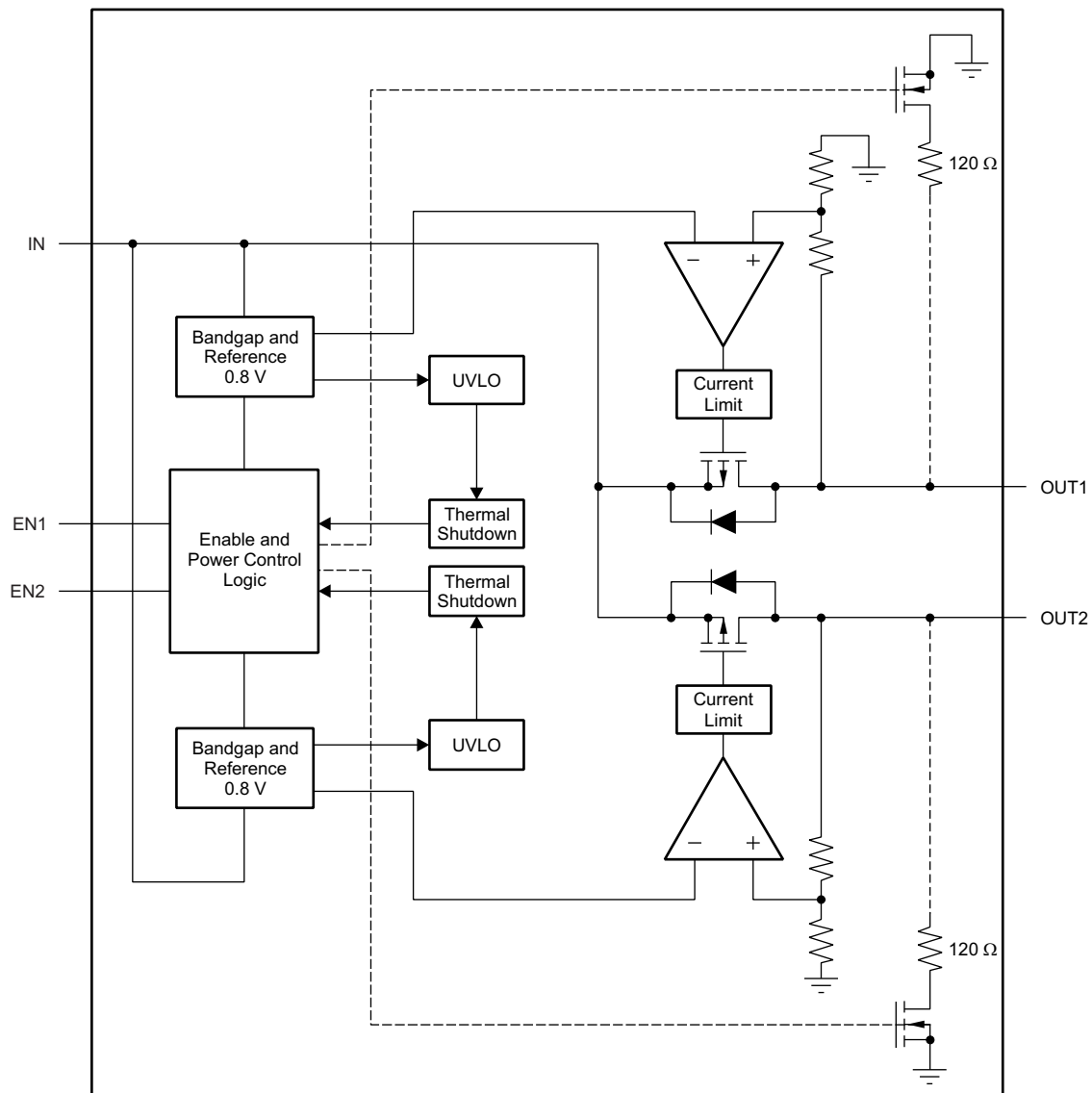

NOTE: Dashed lines are for the TLV716P only.

## 7.3 Feature Description

### 7.3.1 Internal Current Limit

The TLV716 and TLV716P have an internal foldback current limit that helps protect the regulator during fault conditions. The current supplied by the device gradually reduces while the output voltage decreases. When the output is connected to ground, the LDO supplies a typical current of 40 mA. When in current limit, the output voltage is not regulated and  $V_{OUT} = I_{OUT} \times R_{LOAD}$ ; see [Figure 10](#) and [Figure 11](#). The PMOS pass transistor dissipates  $[(V_{IN} - V_{OUT}) \times I_{LIMIT}]$  until thermal shutdown is triggered and the device turns off. When the device cools down, the internal thermal shutdown circuit turns on the device. If the fault condition continues, the device cycles between current limit and thermal shutdown. See the [Thermal Considerations](#) section for more details.

The TLV716 PMOS pass element has a built-in body diode that conducts current when the voltage at OUT exceeds the voltage at IN. This current is not limited, so if extended reverse voltage operation is anticipated, external limiting to 5% of the rated output current is recommended. A small schottky diode connected with the anode to OUT and the cathode to IN can accomplish this limiting.

### 7.3.2 Shutdown

The enable pin (EN) is active high. The device is enabled when the EN pin goes above 0.9 V. This relatively low value of voltage required to turn the LDO regulator on can be used to enable the device with the general-purpose input/output (GPIO) of recent processors whose GPIO voltage is lower than traditional microcontrollers.

The device is turned off when the EN pin is held at less than 0.4 V. When shutdown capability is not required, the EN pin can be connected to the IN pin. The TLV716P will pull down the output with a 120-Ω resistor when the EN pin falls below 0.4 V.

### 7.3.3 Undervoltage Lockout (UVLO)

The TLV716 and TLV716P use an undervoltage lockout circuit (1.3 V, typical) to keep the output shut off until the internal circuitry is operating properly.

## 7.4 Device Functional Modes

### 7.4.1 Capacitor-Free Operation

The TLV716 and TLV716P are stable without the use of input or output capacitors. This functionality results in a reduction of component count, cost, and solution size. In addition, without the need of external capacitors, the ultra-small, 1.2-mm × 1.2-mm DPQ package optimizes the solution size for board space-constrained applications. To optimize device AC performance, an input and output capacitor is recommended, as described in the [Input and Output Capacitor Requirements](#) section.

## 8 Application and Implementation

### NOTE

Information in the following applications sections is not part of the TI component specification, and TI does not warrant its accuracy or completeness. TI's customers are responsible for determining suitability of components for their purposes. Customers should validate and test their design implementation to confirm system functionality.

### 8.1 Application Information

The TLV716 and TLV716P belong to a family of dual-channel, capacitor-free, 150-mA, low-dropout voltage (LDO) regulators. These devices can be used with or without external capacitors and are available in a 1.2-mm x 1.2-mm package, making these devices a very small solution size for dual-channel, low-dropout (LDO) regulators. This family of LDO regulators offers current limit and thermal protection, and is specified from  $-40^{\circ}\text{C}$  to  $85^{\circ}\text{C}$ . [Figure 24](#) shows an application circuit for this family of devices.

### 8.2 Typical Application

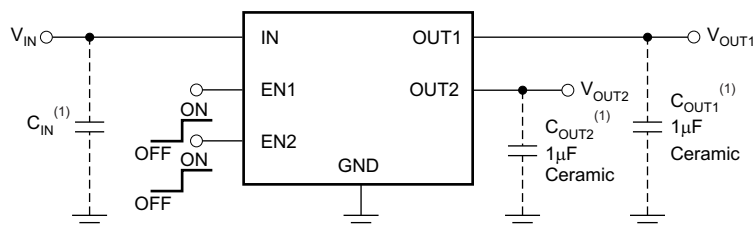

(1) Optional.

**Figure 24. Typical Application Circuit**

#### 8.2.1 Design Requirements

[Table 1](#) lists the design requirements.

**Table 1. Design Parameters**

PARAMETER	DESIGN REQUIREMENT
Input voltage	4.2 V to 3 V (Lithium Ion battery)
Output 1 voltage	2.8 V $\pm$ 1.5%
Output 1 DC current	50 mA
Output 2 voltage	1.8 V $\pm$ 1.5%
Output2 DC current	10 mA
Maximum ambient temperature	65°C

#### 8.2.2 Detailed Design Procedure

An input capacitor is not required for this design because of the low impedance connection directly to the battery. No output capacitor allows for the minimal possible inrush current during start-up, ensuring the 180-mA maximum input current limit is not exceeded. Verify that the maximum junction temperature is not exceeded by calculating the total power dissipation and the junction temperature rise. For this example the total worst case power dissipation is  $(4.2\text{ V} - 2.8\text{ V}) \times 0.05\text{ A} + (4.2\text{ V} - 1.8\text{ V}) \times 0.01 = 0.094\text{ W}$ . The rise in junction temperature is calculated by multiplying the power dissipation by thermal resistance  $R_{\theta\text{JA}}$ . For this example, assuming the board size is similar to the JEDEC High K standard, the rise in junction temperature is  $0.094\text{ W} \times 149.3\text{ }^{\circ}\text{C/W} = 14^{\circ}\text{C}$ . The junction temperature is calculated by adding the rise in junction temperature to the maximum ambient temperature; in this example the maximum junction temperature can be calculated to be  $65^{\circ}\text{C} + 14^{\circ}\text{C} = 79^{\circ}\text{C}$ . It is mandatory to keep the junction temperature below the maximum operating junction temperature. For additional thermal information see the [Thermal Considerations](#) and [Power Dissipation](#) sections.

### 8.2.2.1 Input and Output Capacitor Requirements

The TLV716 and TLV716P uses an advanced internal control loop to obtain stable operation both with or without the use of input or output capacitors. If an output capacitor is used the device can support values as high as 100- $\mu$ F. The dynamic performance of the device is improved with the use of an output capacitor. An output capacitance of 0.1  $\mu$ F or larger generally provides good dynamic response. X5R- and X7R-type ceramic capacitors are recommended because these capacitors have minimal variation in value and equivalent series resistance (ESR) over temperature.

Although an input capacitor is not required for stability, good analog design practice is to connect a 0.1- $\mu$ F to 1- $\mu$ F capacitor from IN to GND. This capacitor counteracts input source impedance and improves supply transient response, input ripple, and PSRR. A higher value capacitor may be necessary if large, fast, rise-time load transients are anticipated or if the device is located several inches from the input power source.

### 8.2.2.2 Dropout Voltage

The TLV716 and TLV716P use a PMOS pass transistor to achieve low dropout. When  $(V_{IN} - V_{OUT})$  is less than the dropout voltage ( $V_{DO}$ ), the PMOS pass device is in the linear region of operation and the input-to-output resistance is the  $R_{DS(ON)}$  of the PMOS pass element.  $V_{DO}$  scales approximately with the output current because the PMOS device behaves like a resistor in dropout.

As with any linear regulator, PSRR and transient response are degraded as  $(V_{IN} - V_{OUT})$  approaches dropout.

### 8.2.3 Application Curves

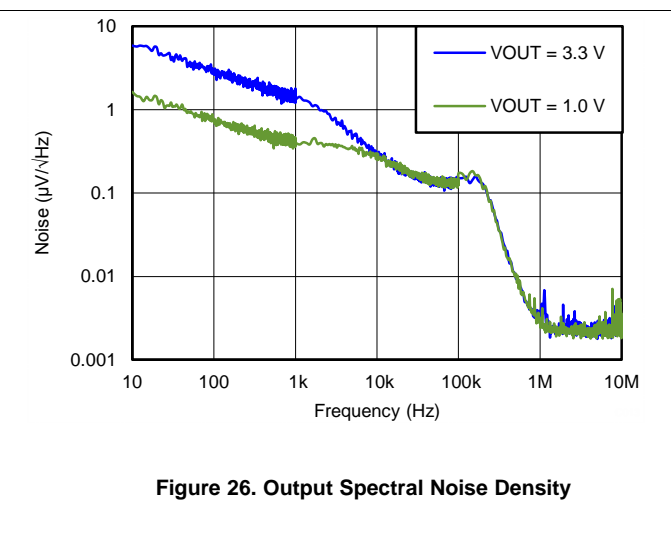
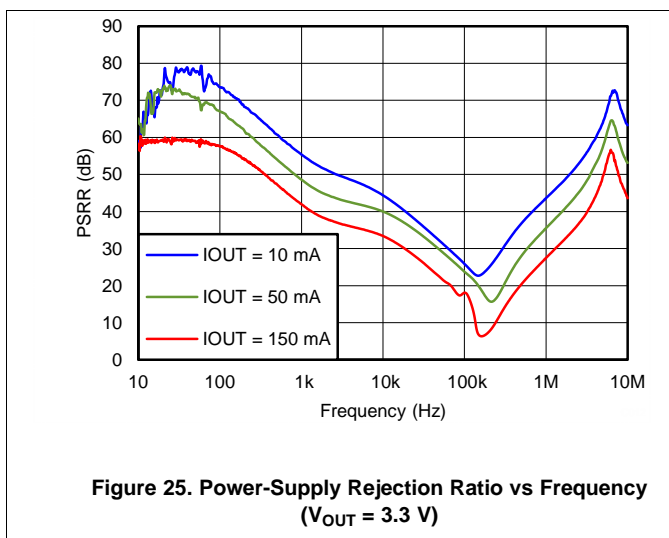

## 9 Power Supply Recommendations

These devices are designed to operate from an input voltage supply range from 1.4 V to 5.5 V. The input voltage range must provide adequate headroom for the device to have a regulated output. This input supply must be well-regulated and stable. If the input supply is noisy, additional input capacitors with low ESR can help improve the output noise performance.

## 10 Layout

### 10.1 Layout Guidelines

If used, place the input and output capacitors as close to the device pins as possible. To maximize AC performance refer to [Figure 27](#).

### 10.2 Layout Example

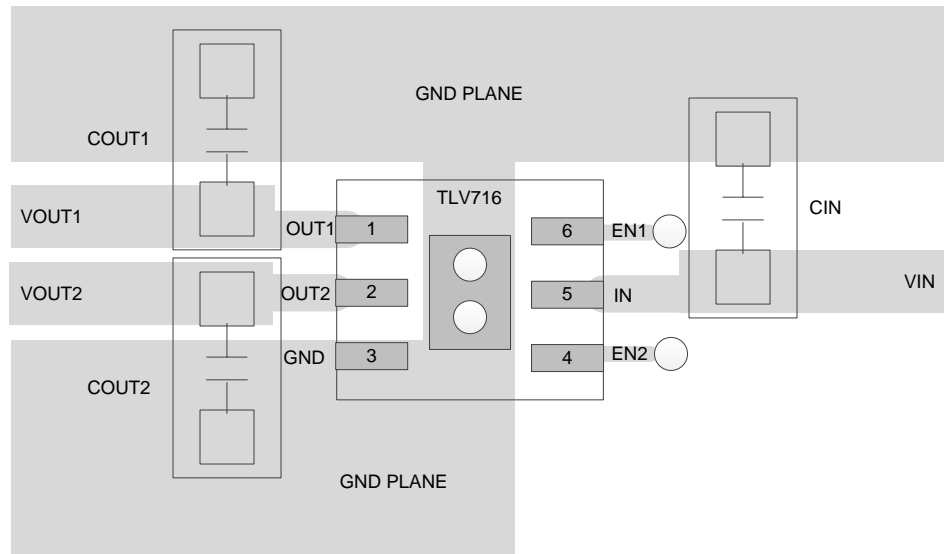

**Figure 27. Layout Recommendation**

### 10.3 Thermal Considerations

Thermal protection disables the output when the junction temperature rises to approximately 158°C, allowing the device to cool. When the junction temperature cools to approximately 140°C, the output circuitry is again enabled. Depending on power dissipation, thermal resistance, and ambient temperature, the thermal protection circuit may cycle on and off. This cycling limits the dissipation of the regulator, protecting it from damage as a result of overheating.

Any tendency to activate the thermal protection circuit indicates excessive power dissipation or an inadequate heatsink. For reliable operation, junction temperature should be limited to 125°C maximum. To estimate the margin of safety in a complete design, increase the ambient temperature until the thermal protection is triggered; use worst-case loads and signal conditions. The ambient temperature at which thermal shutdown occurs on the device is 33°C higher (158°C - 125°C) than the maximum recommended operating conditions.

The internal protection circuitry of the TLV716 and TLV716P is designed to protect against overload conditions. This circuitry is not intended to replace proper PCB layout and heatsinking. Continuously running the device into thermal shutdown degrades reliability.

### 10.4 Power Dissipation

The ability to remove heat from a die is different for each package type, presenting different considerations in the printed-circuit-board (PCB) layout. The copper PCB area around the device that is free of other components moves the heat from the device to ambient air. Performance data for JEDEC high-K boards are given in the [Thermal Information](#) table. Using heavier copper increases effectiveness in removing heat from the device.

Power dissipation ( $P_D$ ) is equal to the product of the output current and the voltage drop across both output pass elements, as shown in [Equation 1](#):

$$P_D = (V_{IN} - V_{OUT1}) \times I_{OUT1} + (V_{IN} - V_{OUT2}) \times I_{OUT2} \quad (1)$$

### Power Dissipation (continued)

The maximum ambient temperature that the device can operate within the maximum  $T_J$  operating temperature of 125°C depends on the thermal impedance and the total power dissipated within the device. Figure 28 and Figure 29 show maximum ambient temperature versus output current for two different LDO configurations. Figure 28 shows the maximum ambient temperature with  $V_{IN} = 3.3\text{ V}$ ,  $V_{OUT1} = 1.8\text{ V}$ , and  $V_{OUT2} = 1\text{ V}$  versus  $I_{OUT1}$ . Figure 29 shows the maximum ambient temperature with  $V_{IN} = 5\text{ V}$ ,  $V_{OUT1} = 3.3\text{ V}$ , and  $V_{OUT2} = 1.8\text{ V}$  versus  $I_{OUT1}$ .

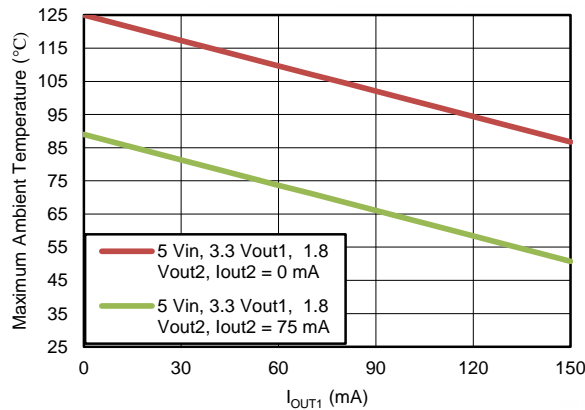

**Figure 28. Maximum Ambient Temperature vs Output Current**  
( $V_{IN} = 5\text{ V}$ ,  $V_{OUT1} = 3.3\text{ V}$ ,  $V_{OUT2} = 1.8\text{ V}$ )

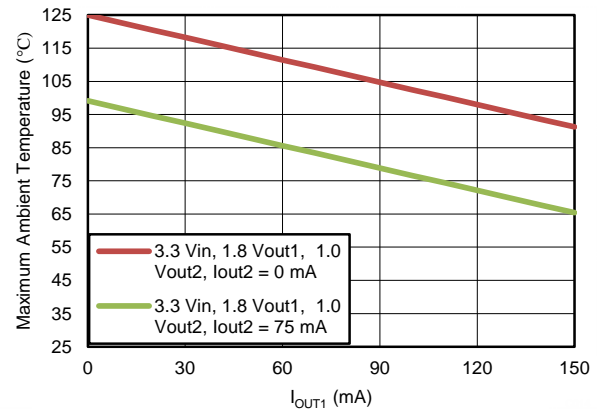

**Figure 29. Maximum Ambient Temperature vs Output Current**  
( $V_{IN} = 3.3\text{ V}$ ,  $V_{OUT1} = 1.8\text{ V}$ ,  $V_{OUT2} = 1\text{ V}$ )

## 11 器件和文档支持

### 11.1 相关链接

下面的表格列出了快速访问链接。范围包括技术文档、支持和社区资源、工具和软件，以及样片或购买的快速访问。

表 2. 相关链接

器件	产品文件夹	样片与购买	技术文档	工具与软件	支持与社区
TLV716	<a href="#">请单击此处</a>	<a href="#">请单击此处</a>	<a href="#">请单击此处</a>	<a href="#">请单击此处</a>	<a href="#">请单击此处</a>
TLV716P	<a href="#">请单击此处</a>	<a href="#">请单击此处</a>	<a href="#">请单击此处</a>	<a href="#">请单击此处</a>	<a href="#">请单击此处</a>

### 11.2 社区资源

The following links connect to TI community resources. Linked contents are provided "AS IS" by the respective contributors. They do not constitute TI specifications and do not necessarily reflect TI's views; see TI's [Terms of Use](#).

**TI E2E™ Online Community** *TI's Engineer-to-Engineer (E2E) Community*. Created to foster collaboration among engineers. At [e2e.ti.com](http://e2e.ti.com), you can ask questions, share knowledge, explore ideas and help solve problems with fellow engineers.

**Design Support** *TI's Design Support* Quickly find helpful E2E forums along with design support tools and contact information for technical support.

### 11.3 商标

E2E is a trademark of Texas Instruments.  
All other trademarks are the property of their respective owners.

### 11.4 静电放电警告



这些装置包含有限的内置 ESD 保护。存储或装卸时，应将导线一起截短或将装置放置于导电泡棉中，以防止 MOS 门极遭受静电损伤。

### 11.5 Glossary

**SLYZ022** — *TI Glossary*.

This glossary lists and explains terms, acronyms, and definitions.

## 12 机械、封装和可订购信息

以下页中包括机械、封装和可订购信息。这些信息是针对指定器件可提供的最新数据。这些数据会在无通知且不对本文档进行修订的情况下发生改变。欲获得该数据表的浏览器版本，请查阅左侧的导航栏。



## 重要声明

德州仪器(TI)及其下属子公司有权根据 JESD46 最新标准,对所提供的产品和服务进行更正、修改、增强、改进或其它更改,并有权根据 JESD48 最新标准中止提供任何产品和服务。客户在下订单前应获取最新的相关信息,并验证这些信息是否完整且是最新的。所有产品的销售都遵循在订单确认时所提供的TI 销售条款与条件。

TI 保证其所销售的组件的性能符合产品销售时 TI 半导体产品销售条件与条款的适用规范。仅在 TI 保证的范围内,且 TI 认为有必要时才会使用测试或其它质量控制技术。除非适用法律做出了硬性规定,否则没有必要对每种组件的所有参数进行测试。

TI 对应用帮助或客户产品设计不承担任何义务。客户应对其使用 TI 组件的产品和应用自行负责。为尽量减小与客户产品和应用相关的风险,客户应提供充分的设计与操作安全措施。

TI 不对任何 TI 专利权、版权、屏蔽作品权或其它与使用了 TI 组件或服务的组合设备、机器或流程相关的 TI 知识产权中授予的直接或隐含权限作出任何保证或解释。TI 所发布的与第三方产品或服务有关的信息,不能构成从 TI 获得使用这些产品或服务的许可、授权、或认可。使用此类信息可能需要获得第三方的专利权或其它知识产权方面的许可,或是 TI 的专利权或其它知识产权方面的许可。

对于 TI 的产品手册或数据表中 TI 信息的重要部分,仅在没有对内容进行任何篡改且带有相关授权、条件、限制和声明的情况下才允许进行复制。TI 对此类篡改过的文件不承担任何责任或义务。复制第三方的信息可能需要服从额外的限制条件。

在转售 TI 组件或服务时,如果对该组件或服务参数的陈述与 TI 标明的参数相比存在差异或虚假成分,则会失去相关 TI 组件或服务的所有明示或暗示授权,且这是不正当的、欺诈性商业行为。TI 对任何此类虚假陈述均不承担任何责任或义务。

客户认可并同意,尽管任何应用相关信息或支持仍可能由 TI 提供,但他们将独立负责满足与其产品及其在应用中使用的 TI 产品相关的所有法律、法规和安全相关要求。客户声明并同意,他们具备制定与实施安全措施所需的全部专业技术和知识,可预见故障的危险后果、监测故障及其后果、降低有可能造成人身伤害的故障的发生机率并采取适当的补救措施。客户将全额赔偿因在此类安全关键应用中使用任何 TI 组件而对 TI 及其代理造成的任何损失。

在某些场合中,为了推进安全相关应用有可能对 TI 组件进行特别的促销。TI 的目标是利用此类组件帮助客户设计和创立其特有的可满足适用的功能安全性标准和要求的终端产品解决方案。尽管如此,此类组件仍然服从这些条款。

TI 组件未获得用于 FDA Class III (或类似的生命攸关医疗设备)的授权许可,除非各方授权官员已经达成了专门管控此类使用的特别协议。

只有那些 TI 特别注明属于军用等级或“增强型塑料”的 TI 组件才是设计或专门用于军事/航空应用或环境的。购买者认可并同意,对并非指定面向军事或航空航天用途的 TI 组件进行军事或航空航天方面的应用,其风险由客户单独承担,并且由客户独立负责满足与此类使用相关的所有法律和法规要求。

TI 已明确指定符合 ISO/TS16949 要求的产品,这些产品主要用于汽车。在任何情况下,因使用非指定产品而无法达到 ISO/TS16949 要求, TI 不承担任何责任。

	产品		应用
数字音频	<a href="http://www.ti.com.cn/audio">www.ti.com.cn/audio</a>	通信与电信	<a href="http://www.ti.com.cn/telecom">www.ti.com.cn/telecom</a>
放大器和线性器件	<a href="http://www.ti.com.cn/amplifiers">www.ti.com.cn/amplifiers</a>	计算机及周边	<a href="http://www.ti.com.cn/computer">www.ti.com.cn/computer</a>
数据转换器	<a href="http://www.ti.com.cn/dataconverters">www.ti.com.cn/dataconverters</a>	消费电子	<a href="http://www.ti.com.cn/consumer-apps">www.ti.com.cn/consumer-apps</a>
DLP® 产品	<a href="http://www.dlp.com">www.dlp.com</a>	能源	<a href="http://www.ti.com.cn/energy">www.ti.com.cn/energy</a>
DSP - 数字信号处理器	<a href="http://www.ti.com.cn/dsp">www.ti.com.cn/dsp</a>	工业应用	<a href="http://www.ti.com.cn/industrial">www.ti.com.cn/industrial</a>
时钟和计时器	<a href="http://www.ti.com.cn/clockandtimers">www.ti.com.cn/clockandtimers</a>	医疗电子	<a href="http://www.ti.com.cn/medical">www.ti.com.cn/medical</a>
接口	<a href="http://www.ti.com.cn/interface">www.ti.com.cn/interface</a>	安防应用	<a href="http://www.ti.com.cn/security">www.ti.com.cn/security</a>
逻辑	<a href="http://www.ti.com.cn/logic">www.ti.com.cn/logic</a>	汽车电子	<a href="http://www.ti.com.cn/automotive">www.ti.com.cn/automotive</a>
电源管理	<a href="http://www.ti.com.cn/power">www.ti.com.cn/power</a>	视频和影像	<a href="http://www.ti.com.cn/video">www.ti.com.cn/video</a>
微控制器 (MCU)	<a href="http://www.ti.com.cn/microcontrollers">www.ti.com.cn/microcontrollers</a>		
RFID 系统	<a href="http://www.ti.com.cn/rfidsys">www.ti.com.cn/rfidsys</a>		
OMAP应用处理器	<a href="http://www.ti.com/omap">www.ti.com/omap</a>		
无线连通性	<a href="http://www.ti.com.cn/wirelessconnectivity">www.ti.com.cn/wirelessconnectivity</a>	德州仪器在线技术支持社区	<a href="http://www.deyisupport.com">www.deyisupport.com</a>

邮寄地址: 上海市浦东新区世纪大道1568号, 中建大厦32楼邮政编码: 200122  
Copyright © 2016, 德州仪器半导体技术(上海)有限公司

**PACKAGING INFORMATION**

Orderable Device	Status (1)	Package Type	Package Drawing	Pins	Package Qty	Eco Plan (2)	Lead finish/ Ball material (6)	MSL Peak Temp (3)	Op Temp (°C)	Device Marking (4/5)	Samples
TLV716120275PDPQR	ACTIVE	X2SON	DPQ	6	3000	RoHS & Green	NIPDAU	Level-1-260C-UNLIM	-40 to 125	EI	<a href="#">Samples</a>
TLV716120275PDPQT	ACTIVE	X2SON	DPQ	6	250	RoHS & Green	NIPDAU	Level-1-260C-UNLIM	-40 to 125	EI	<a href="#">Samples</a>
TLV7162818PDPQR	ACTIVE	X2SON	DPQ	6	3000	RoHS & Green	NIPDAU	Level-1-260C-UNLIM	-40 to 125	CW	<a href="#">Samples</a>
TLV7162818PDPQT	ACTIVE	X2SON	DPQ	6	250	RoHS & Green	NIPDAU	Level-1-260C-UNLIM	-40 to 125	CW	<a href="#">Samples</a>
TLV7162828PDPQR	ACTIVE	X2SON	DPQ	6	3000	RoHS & Green	NIPDAU	Level-1-260C-UNLIM	-40 to 125	CX	<a href="#">Samples</a>
TLV7162828PDPQT	ACTIVE	X2SON	DPQ	6	250	RoHS & Green	NIPDAU	Level-1-260C-UNLIM	-40 to 125	CX	<a href="#">Samples</a>
TLV7163030PDPQR	ACTIVE	X2SON	DPQ	6	3000	RoHS & Green	NIPDAU	Level-1-260C-UNLIM	-40 to 125	CY	<a href="#">Samples</a>
TLV7163030PDPQT	ACTIVE	X2SON	DPQ	6	250	RoHS & Green	NIPDAU	Level-1-260C-UNLIM	-40 to 125	CY	<a href="#">Samples</a>
TLV7163318PDPQR	ACTIVE	X2SON	DPQ	6	3000	RoHS & Green	NIPDAU	Level-1-260C-UNLIM	-40 to 125	CZ	<a href="#">Samples</a>
TLV7163318PDPQT	ACTIVE	X2SON	DPQ	6	250	RoHS & Green	NIPDAU	Level-1-260C-UNLIM	-40 to 125	CZ	<a href="#">Samples</a>

(1) The marketing status values are defined as follows:

**ACTIVE:** Product device recommended for new designs.

**LIFEBUY:** TI has announced that the device will be discontinued, and a lifetime-buy period is in effect.

**NRND:** Not recommended for new designs. Device is in production to support existing customers, but TI does not recommend using this part in a new design.

**PREVIEW:** Device has been announced but is not in production. Samples may or may not be available.

**OBSOLETE:** TI has discontinued the production of the device.

(2) **RoHS:** TI defines "RoHS" to mean semiconductor products that are compliant with the current EU RoHS requirements for all 10 RoHS substances, including the requirement that RoHS substance do not exceed 0.1% by weight in homogeneous materials. Where designed to be soldered at high temperatures, "RoHS" products are suitable for use in specified lead-free processes. TI may reference these types of products as "Pb-Free".

**RoHS Exempt:** TI defines "RoHS Exempt" to mean products that contain lead but are compliant with EU RoHS pursuant to a specific EU RoHS exemption.

**Green:** TI defines "Green" to mean the content of Chlorine (Cl) and Bromine (Br) based flame retardants meet JS709B low halogen requirements of <=1000ppm threshold. Antimony trioxide based flame retardants must also meet the <=1000ppm threshold requirement.

(3) MSL, Peak Temp. - The Moisture Sensitivity Level rating according to the JEDEC industry standard classifications, and peak solder temperature.

(4) There may be additional marking, which relates to the logo, the lot trace code information, or the environmental category on the device.

<sup>(5)</sup> Multiple Device Markings will be inside parentheses. Only one Device Marking contained in parentheses and separated by a "~" will appear on a device. If a line is indented then it is a continuation of the previous line and the two combined represent the entire Device Marking for that device.

<sup>(6)</sup> Lead finish/Ball material - Orderable Devices may have multiple material finish options. Finish options are separated by a vertical ruled line. Lead finish/Ball material values may wrap to two lines if the finish value exceeds the maximum column width.

**Important Information and Disclaimer:**The information provided on this page represents TI's knowledge and belief as of the date that it is provided. TI bases its knowledge and belief on information provided by third parties, and makes no representation or warranty as to the accuracy of such information. Efforts are underway to better integrate information from third parties. TI has taken and continues to take reasonable steps to provide representative and accurate information but may not have conducted destructive testing or chemical analysis on incoming materials and chemicals. TI and TI suppliers consider certain information to be proprietary, and thus CAS numbers and other limited information may not be available for release.

In no event shall TI's liability arising out of such information exceed the total purchase price of the TI part(s) at issue in this document sold by TI to Customer on an annual basis.

**TAPE AND REEL INFORMATION**

**QUADRANT ASSIGNMENTS FOR PIN 1 ORIENTATION IN TAPE**

\*All dimensions are nominal

Device	Package Type	Package Drawing	Pins	SPQ	Reel Diameter (mm)	Reel Width W1 (mm)	A0 (mm)	B0 (mm)	K0 (mm)	P1 (mm)	W (mm)	Pin1 Quadrant
TLV7162818PDPQR	X2SON	DPQ	6	3000	180.0	9.5	1.33	1.33	0.47	4.0	8.0	Q2
TLV7162818PDPQT	X2SON	DPQ	6	250	180.0	9.5	1.33	1.33	0.47	4.0	8.0	Q2
TLV7162828PDPQR	X2SON	DPQ	6	3000	180.0	9.5	1.33	1.33	0.47	4.0	8.0	Q2
TLV7162828PDPQT	X2SON	DPQ	6	250	180.0	9.5	1.33	1.33	0.47	4.0	8.0	Q2
TLV7163030PDPQR	X2SON	DPQ	6	3000	180.0	9.5	1.33	1.33	0.47	4.0	8.0	Q2
TLV7163030PDPQT	X2SON	DPQ	6	250	180.0	9.5	1.33	1.33	0.47	4.0	8.0	Q2
TLV7163318PDPQR	X2SON	DPQ	6	3000	180.0	9.5	1.33	1.33	0.47	4.0	8.0	Q2
TLV7163318PDPQT	X2SON	DPQ	6	250	180.0	9.5	1.33	1.33	0.47	4.0	8.0	Q2

**TAPE AND REEL BOX DIMENSIONS**

\*All dimensions are nominal

Device	Package Type	Package Drawing	Pins	SPQ	Length (mm)	Width (mm)	Height (mm)
TLV7162818PDPQR	X2SON	DPQ	6	3000	184.0	184.0	19.0
TLV7162818PDPQT	X2SON	DPQ	6	250	184.0	184.0	19.0
TLV7162828PDPQR	X2SON	DPQ	6	3000	184.0	184.0	19.0
TLV7162828PDPQT	X2SON	DPQ	6	250	184.0	184.0	19.0
TLV7163030PDPQR	X2SON	DPQ	6	3000	184.0	184.0	19.0
TLV7163030PDPQT	X2SON	DPQ	6	250	184.0	184.0	19.0
TLV7163318PDPQR	X2SON	DPQ	6	3000	184.0	184.0	19.0
TLV7163318PDPQT	X2SON	DPQ	6	250	184.0	184.0	19.0

DPQ (S-PX2SON-N6)

PLASTIC SMALL OUTLINE NO-LEAD

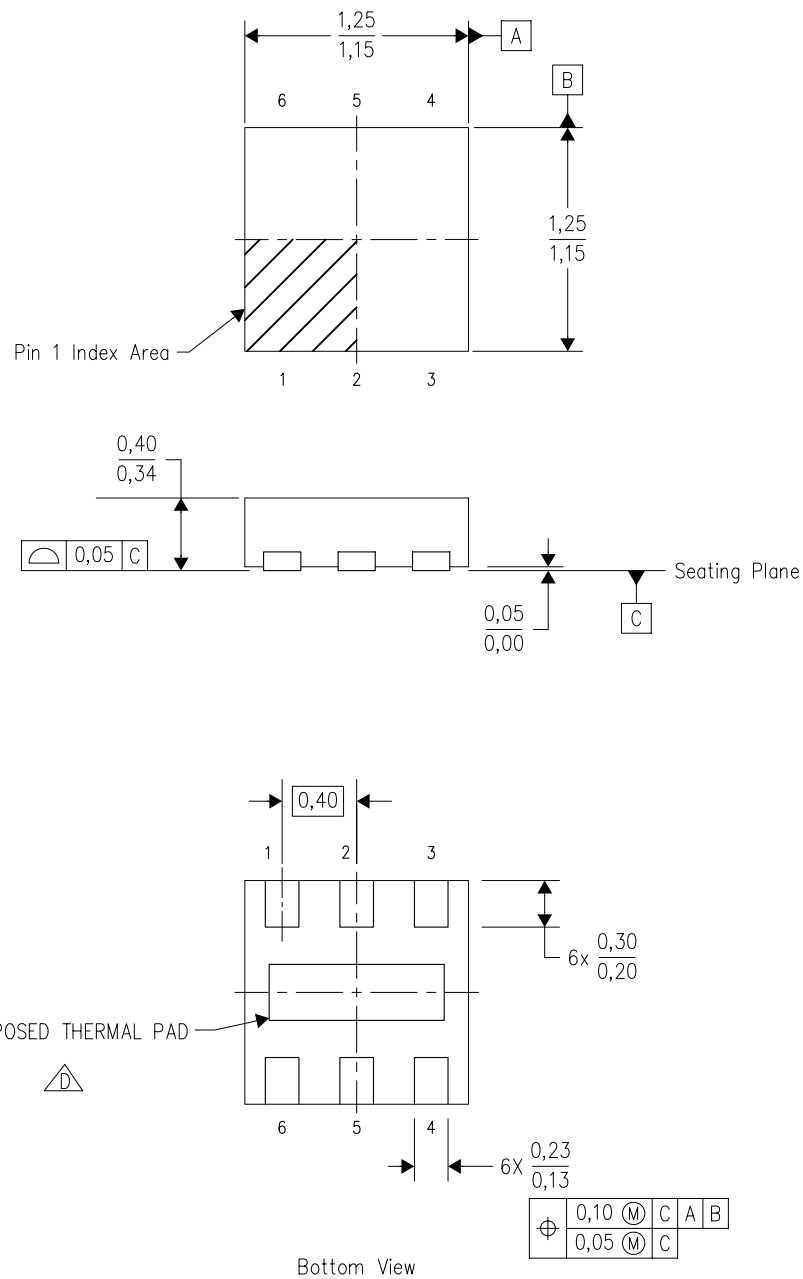

4211511/A 12/10

- NOTES:
- A. All linear dimensions are in millimeters. Dimensioning and tolerancing per ASME Y14.5M-1994.
  - B. This drawing is subject to change without notice.
  - C. SON (Small Outline No-Lead) package configuration.
  -  The package thermal pad must be soldered to the board for thermal and mechanical performance. See the Product Data Sheet for details regarding the exposed thermal pad dimensions.

# THERMAL PAD MECHANICAL DATA

DPQ (S-PX2SON-N6)

PLASTIC SMALL OUTLINE NO-LEAD

## THERMAL INFORMATION

This package incorporates an exposed thermal pad that is designed to be attached directly to an external heatsink. The thermal pad must be soldered directly to the printed circuit board (PCB). After soldering, the PCB can be used as a heatsink. In addition, through the use of thermal vias, the thermal pad can be attached directly to the appropriate copper plane shown in the electrical schematic for the device, or alternatively, can be attached to a special heatsink structure designed into the PCB. This design optimizes the heat transfer from the integrated circuit (IC).

For information on the Quad Flatpack No-Lead (QFN) package and its advantages, refer to Application Report, QFN/SON PCB Attachment, Texas Instruments Literature No. SLUA271. This document is available at [www.ti.com](http://www.ti.com).

The exposed thermal pad dimensions for this package are shown in the following illustration.

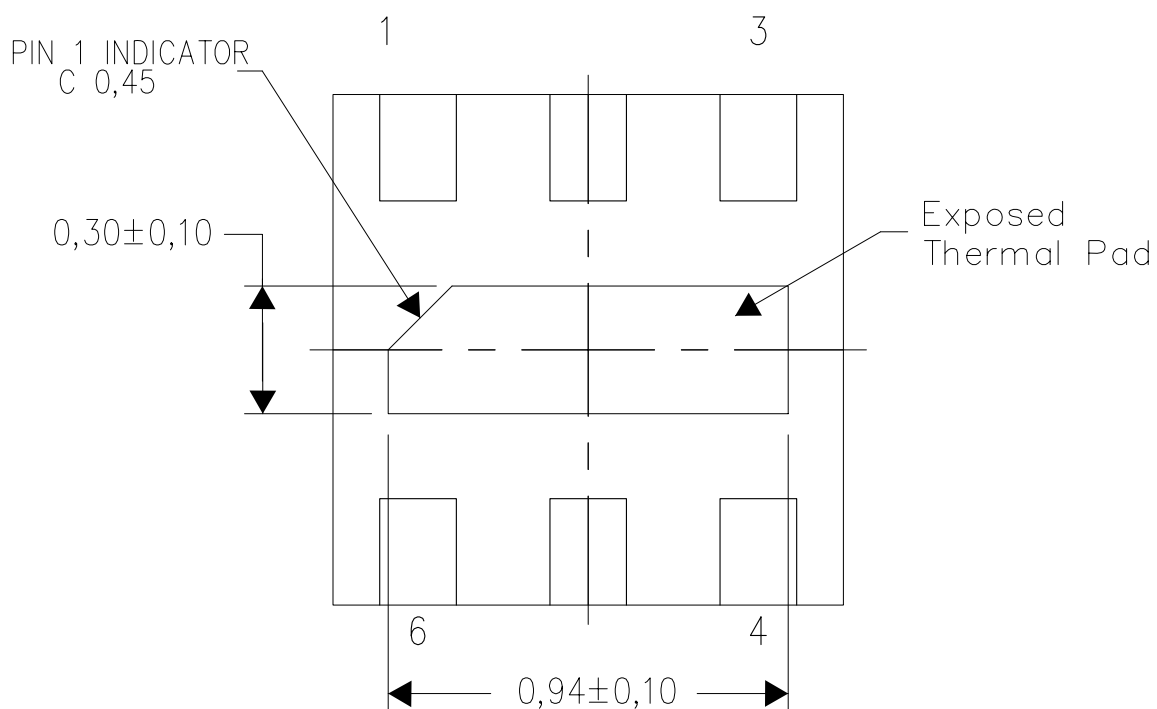

Bottom View

Exposed Thermal Pad Dimensions

4211579/B 02/12

NOTES: All linear dimensions are in millimeters

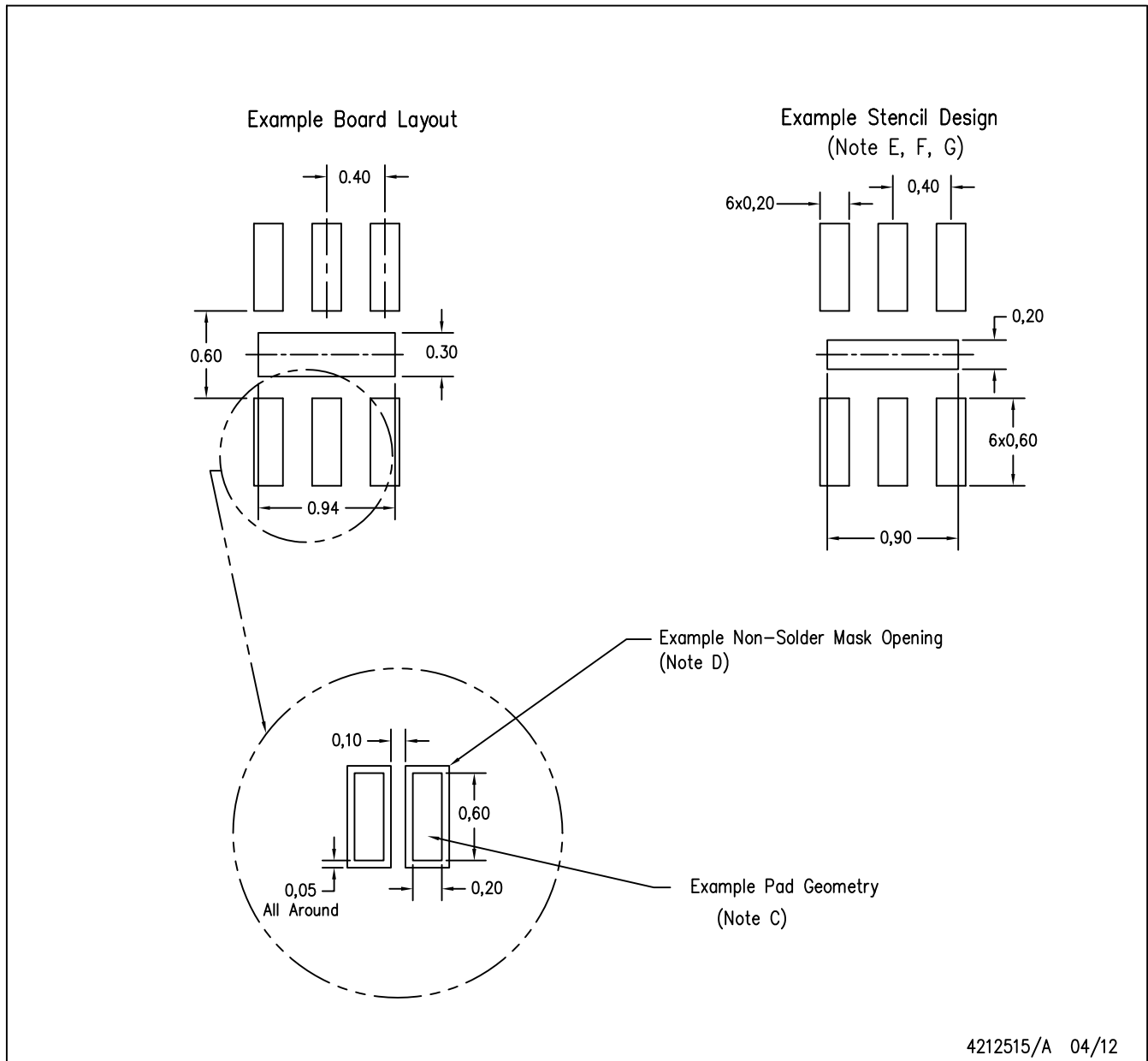

- NOTES:
- All linear dimensions are in millimeters.
  - This drawing is subject to change without notice.
  - Publication IPC-7351 is recommended for alternate designs.
  - Customers should contact their board fabrication site for minimum solder mask web tolerances between signal pads.
  - Maximum stencil thickness 0,127 mm (5 mils). All linear dimensions are in millimeters.
  - Laser cutting apertures with trapezoidal walls and also rounding corners will offer better paste release. Customers should contact their board assembly site for stencil design recommendations. Refer to IPC 7525 for stencil design considerations.
  - Side aperture dimensions over-print land for acceptable area ratio > 0.66. Customer may reduce side aperture dimensions if stencil manufacturing process allows for sufficient release at smaller opening.



## 重要声明和免责声明

TI 均以“原样”提供技术性及其可靠性数据（包括数据表）、设计资源（包括参考设计）、应用或其他设计建议、网络工具、安全信息和其他资源，不保证其中不含任何瑕疵，且不做任何明示或暗示的担保，包括但不限于对适销性、适合某特定用途或不侵犯任何第三方知识产权的暗示担保。

所述资源可供专业开发人员应用TI 产品进行设计使用。您将对以下行为独自承担全部责任：(1) 针对您的应用选择合适的TI 产品；(2) 设计、验证并测试您的应用；(3) 确保您的应用满足相应标准以及任何其他安全、安保或其他要求。所述资源如有变更，恕不另行通知。TI 对您使用所述资源的授权仅限于开发资源所涉及TI 产品的相关应用。除此之外不得复制或展示所述资源，也不提供其它TI 或任何第三方的知识产权授权许可。如因使用所述资源而产生任何索赔、赔偿、成本、损失及债务等，TI 对此概不负责，并且您须赔偿由此对TI 及其代表造成的损害。

TI 所提供产品均受TI 的销售条款 (<http://www.ti.com.cn/zh-cn/legal/termsofsale.html>) 以及 [ti.com.cn](http://www.ti.com.cn) 上或随附TI 产品提供的其他可适用条款的约束。TI 提供所述资源并不扩展或以其他方式更改TI 针对TI 产品所发布的可适用的担保范围或担保免责声明。

邮寄地址：上海市浦东新区世纪大道 1568 号中建大厦 32 楼，邮政编码：200122

Copyright © 2020 德州仪器半导体技术（上海）有限公司

## X-ON Electronics

Largest Supplier of Electrical and Electronic Components

*Click to view similar products for [LDO Voltage Regulators](#) category:*

*Click to view products by [Texas Instruments](#) manufacturer:*

Other Similar products are found below :

[AP7363-SP-13](#) [NCV8664CST33T3G](#) [L79M05TL-E](#) [AP7362-HA-7](#) [PT7M8202B12TA5EX](#) [TCR3DF185,LM\(CT](#) [TLF4949EJ](#)  
[NCP4687DH15T1G](#) [NCV8703MX30TCG](#) [LP2951CN](#) [NCV4269CPD50R2G](#) [AP7315-25W5-7](#) [NCV47411PAAJR2G](#) [AP2111H-1.2TRG1](#)  
[ZLDO1117QK50TC](#) [AZ1117ID-ADJTRG1](#) [NCV4263-2CPD50R2G](#) [NCP114BMX075TCG](#) [MC33269T-3.5G](#) [TLE4471GXT](#) [AP7315-33SA-](#)  
[7](#) [NCV4266-2CST33T3G](#) [NCP715SQ15T2G](#) [NCV8623MN-50R2G](#) [NCV563SQ18T1G](#) [NCV8664CDT33RKG](#) [NCV4299CD250R2G](#)  
[NCP715MX30TBG](#) [NCV8702MX25TCG](#) [TLE7270-2E](#) [NCV562SQ25T1G](#) [AP2213D-3.3TRG1](#) [AP2202K-2.6TRE1](#)  
[NCV8170BMX300TCG](#) [NCV8152MX300180TCG](#) [NCP700CMT45TBG](#) [AP7315-33W5-7](#) [NCP154MX180300TAG](#) [AP2113AMTR-G1](#)  
[NJW4104U2-33A-TE1](#) [MP2013AGG-5-P](#) [NCV8775CDT50RKG](#) [NJM2878F3-45-TE1](#) [S-19214B00A-V5T2U7](#) [S-19214B50A-V5T2U7](#) [S-](#)  
[19213B50A-V5T2U7](#) [S-19214BC0A-E8T1U7\\*1](#) [S-19213B00A-V5T2U7](#) [S-19213B33A-V5T2U7](#) [S-19213BC0A-V5T2U7](#)