

# 采用 1mm × 1mm X2SON 封装的 TLV733P 无电容器、300mA、低压降稳压器

## 1 特性

- 输入电压范围：1.4V 至 5.5V
- 有无电容器均可实现稳定运行
- 折返过流保护
- 封装：
  - 1.0mm × 1.0mm X2SON (4)
  - SOT-23 (5)
- 超低压降：300mA (3.3 V<sub>OUT</sub>) 时为 125mV
- 精度：典型值 1%，最大值 1.4%
- 低 I<sub>Q</sub>：34μA
- 可提供固定输出电压：1.0V 至 3.3V
- 高电源抑制比 (PSRR)：1kHz 频率时为 50dB
- 有源输出放电

## 2 应用

- 平板电脑
- 智能手机
- 笔记本和台式计算机
- 便携式工业和消费类产品
- 无线局域网 (WLAN) 和其他 PC 附加卡
- 摄像机模块

## 3 说明

TLV733 系列低压降线性稳压器 (LDO) 尺寸超小且静态电流较低，可提供 300mA 的拉电流，并且线路和负载瞬态性能出色。此系列器件可提供典型值为 1% 的精度。

TLV733 系列采用现代无电容架构设计，无需使用输入或输出电容即可确保运行稳定。移除输出电容有助于减小解决方案的尺寸，并且可以消除启动时的浪涌电流。不过，TLV733 系列在使用陶瓷输出电容时也可以稳定运行。使用输出电容时，TLV733 还可以在器件上电和使能期间提供折返电流控制。此功能对于电池供电类器件尤为重要。

TLV733 提供了有源下拉电路，当被禁用时可以使输出负载快速放电。

TLV733 系列采用标准的 DBV (SOT-23) 和 DQN (X2SON) 封装。

器件信息<sup>(1)</sup>

器件型号	封装	封装尺寸 (标称值)
TLV733P	SOT-23 (5)	2.90mm × 1.60mm
	X2SON (4)	1.00mm × 1.00mm

(1) 要了解所有可用封装，请参见数据表末尾的封装选项附录。

典型应用电路

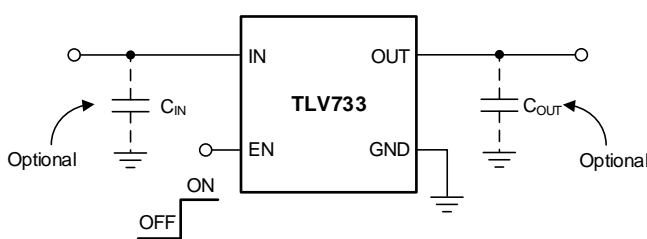

压降电压与输出电流间的关系

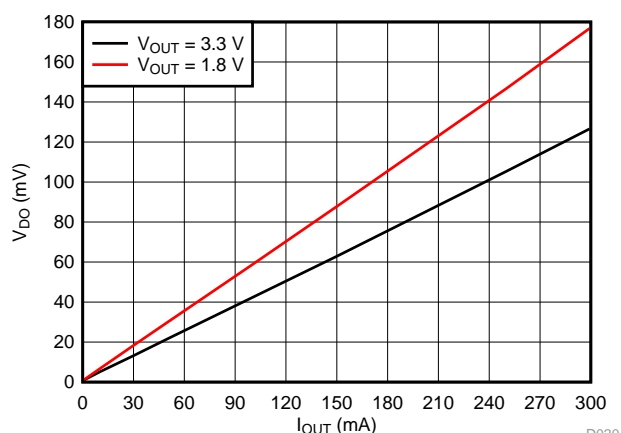

D020



## 目录

1 特性 .....	1	8 Application and Implementation .....	16
2 应用 .....	1	8.1 Application Information.....	16
3 说明 .....	1	8.2 Typical Applications .....	18
4 修订历史记录 .....	2	9 Power Supply Recommendations .....	20
5 Pin Configuration and Functions .....	4	10 Layout.....	20
6 Specifications.....	5	10.1 Layout Guidelines .....	20
6.1 Absolute Maximum Ratings .....	5	10.2 Layout Examples.....	20
6.2 ESD Ratings.....	5	11 器件和文档支持 .....	21
6.3 Recommended Operating Conditions.....	5	11.1 器件支持 .....	21
6.4 Thermal Information .....	5	11.2 文档支持 .....	21
6.5 Electrical Characteristics.....	6	11.3 接收文档更新通知 .....	21
6.6 Typical Characteristics .....	7	11.4 社区资源.....	21
7 Detailed Description .....	13	11.5 商标.....	21
7.1 Overview .....	13	11.6 静电放电警告.....	21
7.2 Functional Block Diagram .....	13	11.7 Glossary .....	22
7.3 Feature Description.....	14	12 机械、封装和可订购信息.....	23
7.4 Device Functional Modes.....	15		

## 4 修订历史记录

Changes from Revision B (November 2015) to Revision C	Page
• Changed description of EN pin from 0.9 V to $V_{EN(HI)}$ and from 0.35 V to $V_{EN(LO)}$ .....	4
• Deleted typical specifications from $V_{EN(HI)}$ and $V_{EN(LO)}$ parameters .....	6
• Added maximum specification to $I_{LIM}$ parameter .....	6
• Changed <i>Shutdown and Output Enable</i> title from <i>Shutdown</i> and changed first paragraph.....	14
• Added DBV package to last paragraph of <i>Power Dissipation</i> section.....	17
• 已添加 向器件命名规则 表中添加了 (3) .....	21

Changes from Revision A (December 2014) to Revision B	Page
• 已将低压降特性要点的值从 122mV 改为 125mV，以匹配电气特性中的值.....	1
• 已更改首页曲线图中的 $V_{OUT}$ 标签.....	1
• Changed min junction temperature value from -55 to -40 in <i>Absolute Maximum Ratings</i> table .....	5
• Changed max junction temperature value from 160 to 150 in <i>Absolute Maximum Ratings</i> table .....	5
• Changed max storage temperature value from 150 to 160 in <i>Absolute Maximum Ratings</i> table.....	5
• Added test condition to line regulation parameter in <i>Electrical Characteristics</i> table.....	6
• Changed unit for line regulation parameter from mV/V to mV .....	6
• Added test condition to load regulation parameter in <i>Electrical Characteristics</i> table .....	6

Changes from Original (October 2014) to Revision A	Page
• 已更改数据表首页的标题信息，以反映器件系列而非各个器件.....	1
• 已将输入电压范围 特性 更改为列表中的第一个要点.....	1
• 已更改 首页的典型应用电路；修正了可选电容标识中的错误 .....	1
• Changed format of I/O column contents and order of packages in <i>Pin Functions</i> table .....	4
• Moved storage temperature range specification to <i>Absolute Maximum Ratings</i> table .....	5
• Changed <i>Handling Ratings</i> table title to <i>ESD Ratings</i> , updated table format.....	5
• Added new first row to the $V_{DO}$ parameter in the <i>Electrical Characteristics</i> table.....	6

---

• Changed condition text for <a href="#">Figure 34</a> .....	17
• 已添加 评估模块小节 .....	21
• 已删除 相关链接部分 .....	21

---

## 5 Pin Configuration and Functions

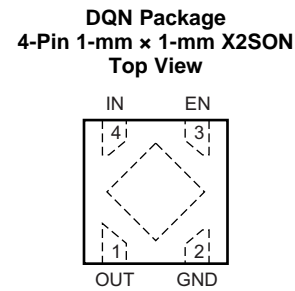
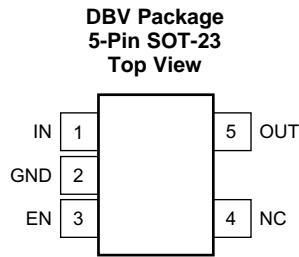

### Pin Functions

PIN		NO.	I/O	DESCRIPTION
NAME	DQN			
EN	3	3	I	Enable pin. Drive EN greater than $V_{EN(HI)}$ to turn on the regulator. Drive EN less than $V_{EN(LO)}$ to put the LDO into shutdown mode.
GND	2	2	—	Ground pin
IN	4	1	I	Input pin. A small capacitor is recommended from this pin to ground. See the <a href="#">Input and Output Capacitor Selection</a> section for more details.
NC	N/A	4	—	No internal connection
OUT	1	5	O	Regulated output voltage pin. For best transient response, use a small 1- $\mu$ F ceramic capacitor from this pin to ground. See the <a href="#">Input and Output Capacitor Selection</a> section for more details.
Thermal pad		—	—	The thermal pad is electrically connected to the GND node. Connect to the GND plane for improved thermal performance.

## 6 Specifications

### 6.1 Absolute Maximum Ratings

over operating junction temperature range (unless otherwise noted); all voltages are with respect to GND<sup>(1)</sup>

		MIN	MAX	UNIT
Voltage	V <sub>IN</sub>	-0.3	6.0	V
	V <sub>EN</sub>	-0.3	V <sub>IN</sub> + 0.3	
	V <sub>OUT</sub>	-0.3	3.6	
Current	I <sub>OUT</sub>	Internally limited		A
Output short-circuit duration		Indefinite		
Temperature	Operating junction, T <sub>J</sub>	-40	150	°C
	Storage, T <sub>stg</sub>	-65	160	

(1) Stresses beyond those listed under *Absolute Maximum Ratings* may cause permanent damage to the device. These are stress ratings only, which do not imply functional operation of the device at these or any other conditions beyond those indicated under *Recommended Operating Conditions*. Exposure to absolute-maximum-rated conditions for extended periods may affect device reliability.

### 6.2 ESD Ratings

			VALUE	UNIT
V <sub>(ESD)</sub>	Electrostatic discharge	Human-body model (HBM), per ANSI/ESDA/JEDEC JS-001 <sup>(1)</sup>	±2000	V
		Charged-device model (CDM), per JEDEC specification JESD22-C101 <sup>(2)</sup>	±500	

(1) JEDEC document JEP155 states that 500-V HBM allows safe manufacturing with a standard ESD control process.

(2) JEDEC document JEP157 states that 250-V CDM allows safe manufacturing with a standard ESD control process.

### 6.3 Recommended Operating Conditions

over operating junction temperature range (unless otherwise noted)

	MIN	NOM	MAX	UNIT
Input range, V <sub>IN</sub>	1.4		5.5	V
Output range, V <sub>OUT</sub>	1.0		3.3	V
Output current, I <sub>OUT</sub>	0		300	mA
Enable range, V <sub>EN</sub>	0		V <sub>IN</sub>	V
Junction temperature, T <sub>J</sub>	-40		125	°C

### 6.4 Thermal Information

THERMAL METRIC <sup>(1)</sup>		TLV733P		UNIT
		DQN (X2SON)	DBV (SOT-23)	
		4 PINS	5 PINS	
R <sub>θJA</sub>	Junction-to-ambient thermal resistance	218.6	228.4	°C/W
R <sub>θJC(top)</sub>	Junction-to-case (top) thermal resistance	164.8	151.5	°C/W
R <sub>θJB</sub>	Junction-to-board thermal resistance	164.9	55.8	°C/W
ψ <sub>JT</sub>	Junction-to-top characterization parameter	5.6	31.4	°C/W
ψ <sub>JB</sub>	Junction-to-board characterization parameter	163.9	54.8	°C/W
R <sub>θJC(bot)</sub>	Junction-to-case (bottom) thermal resistance	131.4	N/A	°C/W

(1) For more information about traditional and new thermal metrics, see the [Semiconductor and IC Package Thermal Metrics application report](#).

## 6.5 Electrical Characteristics

At operating temperature range ( $T_J = -40^\circ\text{C}$  to  $+125^\circ\text{C}$ ),  $V_{IN} = V_{OUT}(\text{nom}) + 0.5\text{ V}$  or  $2.0\text{ V}$  (whichever is greater),  $I_{OUT} = 1\text{ mA}$ ,  $V_{EN} = V_{IN}$ , and  $C_{IN} = C_{OUT} = 1\text{ }\mu\text{F}$  (unless otherwise noted). All typical values at  $T_J = 25^\circ\text{C}$ .

PARAMETER		TEST CONDITIONS		MIN	TYP	MAX	UNIT
$V_{IN}$	Input voltage			1.4		5.5	V
	DC output accuracy	$T_J = 25^\circ\text{C}$		-1%		1%	
		$-40^\circ\text{C} \leq T_J \leq +125^\circ\text{C}$		-1.4%		1.4%	
UVLO	Undervoltage lockout	$V_{IN}$ rising			1.3	1.4	V
		$V_{IN}$ falling			1.25		
$\Delta V_{O(\Delta V)}$	Line regulation	$\Delta VI = V_{IN}(\text{nom})$ to $V_{IN}(\text{nom}) + 1$			1		mV
$\Delta V_{O(\Delta IO)}$	Load regulation	$\Delta IO = 1\text{ mA}$ to $300\text{ mA}$	DQN package		16		mV
			DBV package		25		
$V_{DO}$	Dropout voltage <sup>(1)</sup>	$V_{OUT} = 0.98 \times V_{OUT}(\text{nom})$ , $I_{OUT} = 300\text{ mA}$	$V_{OUT} = 1.1\text{ V}$ , $-40^\circ\text{C} \leq T_J \leq 85^\circ\text{C}$			460	mV
			$1.2\text{ V} \leq V_{OUT} < 1.5\text{ V}$ , $-40^\circ\text{C} \leq T_J \leq 85^\circ\text{C}$			420	
			$1.5\text{ V} \leq V_{OUT} < 1.8\text{ V}$ , $-40^\circ\text{C} \leq T_J \leq 85^\circ\text{C}$			370	
			$1.8\text{ V} \leq V_{OUT} < 2.5\text{ V}$ , $-40^\circ\text{C} \leq T_J \leq 85^\circ\text{C}$			270	
			$2.5\text{ V} \leq V_{OUT} < 3.3\text{ V}$ , $-40^\circ\text{C} \leq T_J \leq 85^\circ\text{C}$			260	
			$V_{OUT} = 3.3\text{ V}$ , $-40^\circ\text{C} \leq T_J \leq 85^\circ\text{C}$		125	220	
			$1.2\text{ V} \leq V_{OUT} < 1.5\text{ V}$ , $-40^\circ\text{C} \leq T_J \leq 125^\circ\text{C}$			450	
			$1.5\text{ V} \leq V_{OUT} < 1.8\text{ V}$ , $-40^\circ\text{C} \leq T_J \leq 125^\circ\text{C}$			400	
			$1.8\text{ V} \leq V_{OUT} < 2.5\text{ V}$ , $-40^\circ\text{C} \leq T_J \leq 125^\circ\text{C}$			300	
			$2.5\text{ V} \leq V_{OUT} < 3.3\text{ V}$ , $-40^\circ\text{C} \leq T_J \leq 125^\circ\text{C}$			290	
			$V_{OUT} = 3.3\text{ V}$ , $-40^\circ\text{C} \leq T_J \leq 125^\circ\text{C}$		125	270	
$I_{GND}$	Ground pin current	$I_{OUT} = 0\text{ mA}$			34	60	$\mu\text{A}$
$I_{SHDN}$	Shutdown current	$V_{EN} \leq 0.35\text{ V}$ , $2.0\text{ V} \leq V_{IN} \leq 5.5\text{ V}$ , $T_J = 25^\circ\text{C}$			0.1	1	$\mu\text{A}$
PSRR	Power-supply rejection ratio	$V_{OUT} = 1.8\text{ V}$ , $I_{OUT} = 300\text{ mA}$	$f = 100\text{ Hz}$		68		dB
			$f = 10\text{ kHz}$		35		
			$f = 100\text{ kHz}$		28		
$V_n$	Output noise voltage	BW = 10 Hz to 100 kHz, $V_{OUT} = 1.8\text{ V}$ , $I_{OUT} = 10\text{ mA}$			120		$\mu\text{V}_{\text{RMS}}$
$V_{EN(HI)}$	EN pin high voltage (enabled)			0.9			V
$V_{EN(LO)}$	EN pin low voltage (disabled)					0.35	V
$I_{EN}$	EN pin current	$V_{EN} = 5.5\text{ V}$			0.01		$\mu\text{A}$
$t_{STR}$	Startup time	Time from EN assertion to $98\% \times V_{OUT}(\text{nom})$ , $V_{OUT} = 1.0\text{ V}$ , $I_{OUT} = 0\text{ mA}$			250		$\mu\text{s}$
		Time from EN assertion to $98\% \times V_{OUT}(\text{nom})$ , $V_{OUT} = 3.3\text{ V}$ , $I_{OUT} = 0\text{ mA}$			800		
	Pull-down resistor	$V_{IN} = 2.3\text{ V}$			120		$\Omega$
$I_{LIM}$	Output current limit			360		700	mA
$I_{OS}$	Short-circuit current limit	$V_{OUT}$ shorted to GND, $V_{OUT} = 1.0\text{ V}$			150		mA
		$V_{OUT}$ shorted to GND, $V_{OUT} = 3.3\text{ V}$			170		
$T_{sd}$	Thermal shutdown	Shutdown, temperature increasing			160		$^\circ\text{C}$
		Reset, temperature decreasing			140		

(1) Dropout voltage for the TLV73310P is not valid at room temperature. The device engages undervoltage lockout ( $V_{IN} < UVLO_{FALL}$ ) before the dropout condition is met.

## 6.6 Typical Characteristics

at operating temperature range ( $T_J = -40^\circ\text{C}$  to  $+125^\circ\text{C}$ ),  $V_{IN} = V_{OUT}(\text{nom}) + 0.5\text{ V}$  or  $2.0\text{ V}$  (whichever is greater),  $I_{OUT} = 1\text{ mA}$ ,  $V_{EN} = V_{IN}$ , and  $C_{IN} = C_{OUT} = 1\ \mu\text{F}$  (unless otherwise noted)

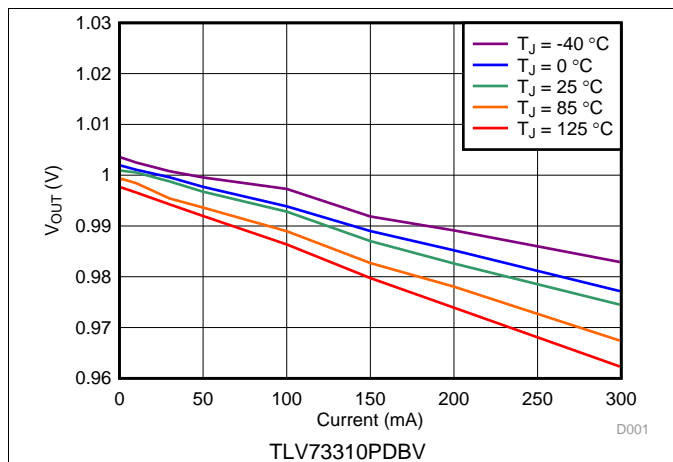

Figure 1. 1.0-V Load Regulation vs  $I_{OUT}$  and Temperature

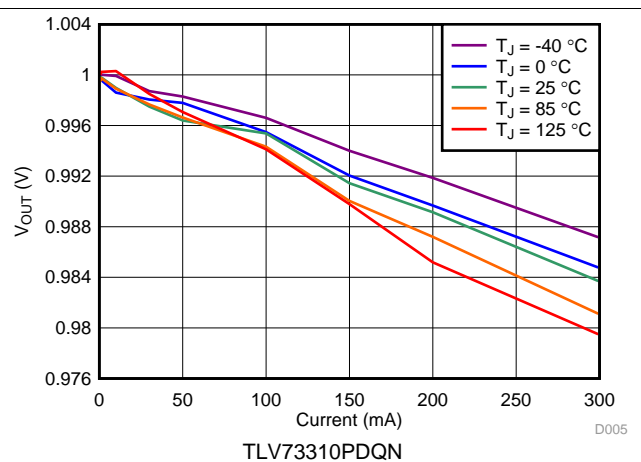

Figure 2. 1.0-V Load Regulation vs  $I_{OUT}$  and Temperature

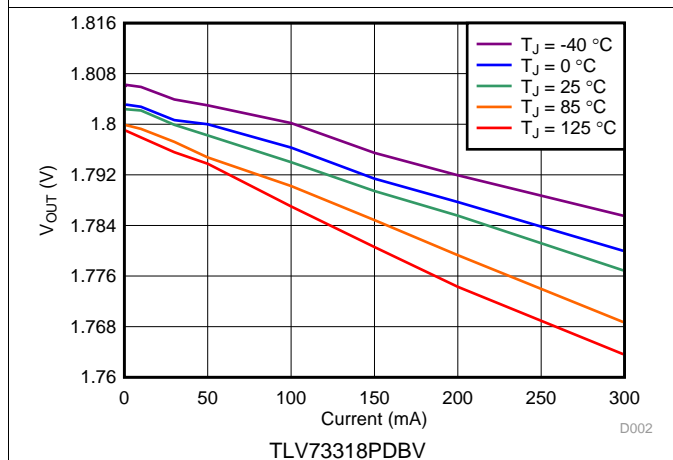

Figure 3. 1.8-V Load Regulation vs  $I_{OUT}$  and Temperature

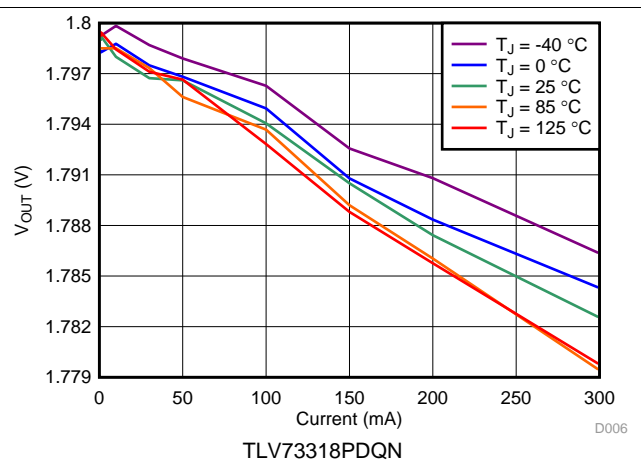

Figure 4. 1.8-V Load Regulation vs  $I_{OUT}$  and Temperature

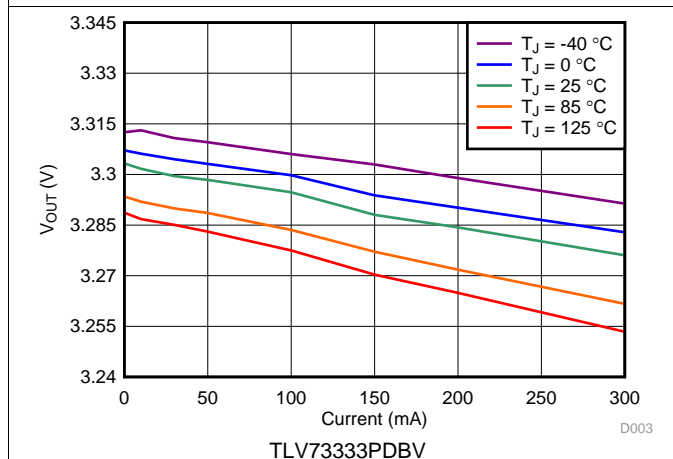

Figure 5. 3.3-V Load Regulation vs  $I_{OUT}$  and Temperature

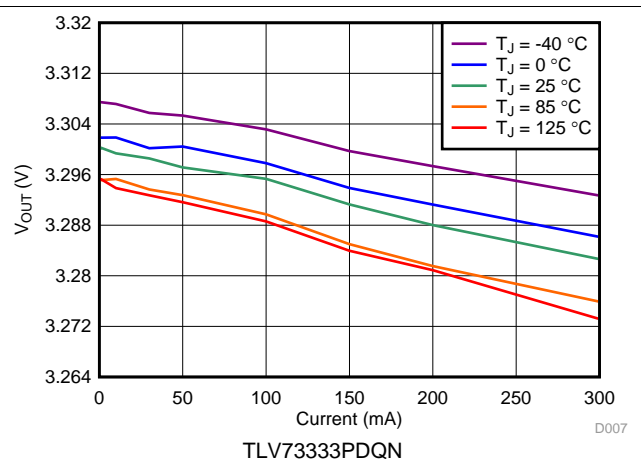

Figure 6. 3.3-V Load Regulation vs  $I_{OUT}$  and Temperature

### Typical Characteristics (continued)

at operating temperature range ( $T_J = -40^{\circ}\text{C}$  to  $+125^{\circ}\text{C}$ ),  $V_{IN} = V_{OUT(nom)} + 0.5\text{ V}$  or  $2.0\text{ V}$  (whichever is greater),  $I_{OUT} = 1\text{ mA}$ ,  $V_{EN} = V_{IN}$ , and  $C_{IN} = C_{OUT} = 1\text{ }\mu\text{F}$  (unless otherwise noted)

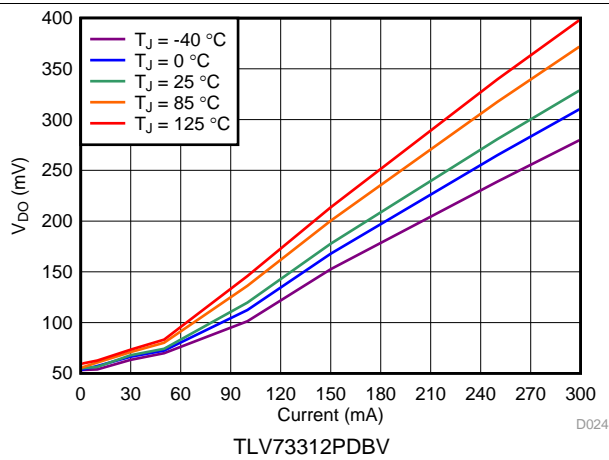

Figure 7. 1.2-V Dropout Voltage vs  $I_{OUT}$  and Temperature

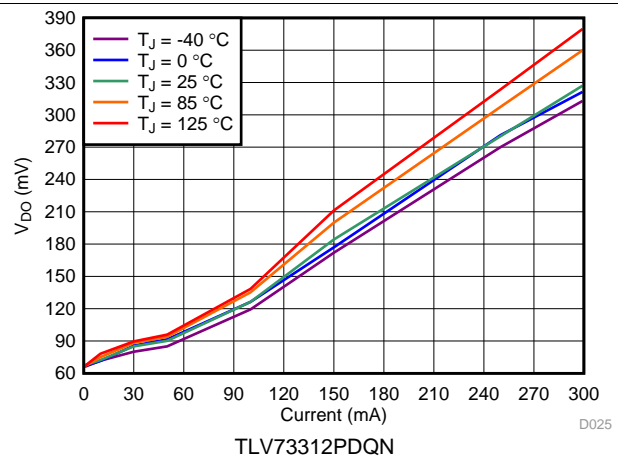

Figure 8. 1.2-V Dropout Voltage vs  $I_{OUT}$  and Temperature

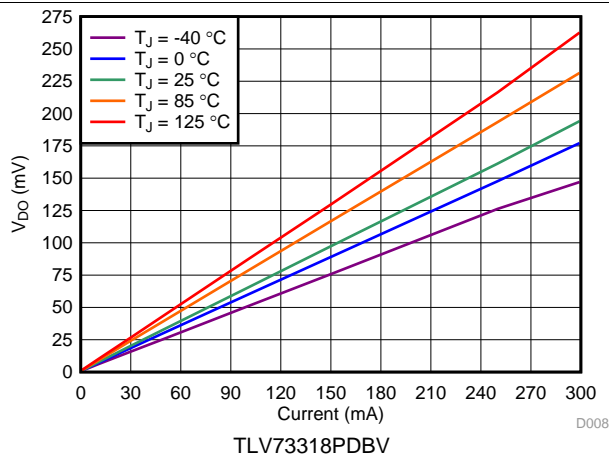

Figure 9. 1.8-V Dropout Voltage vs  $I_{OUT}$  and Temperature

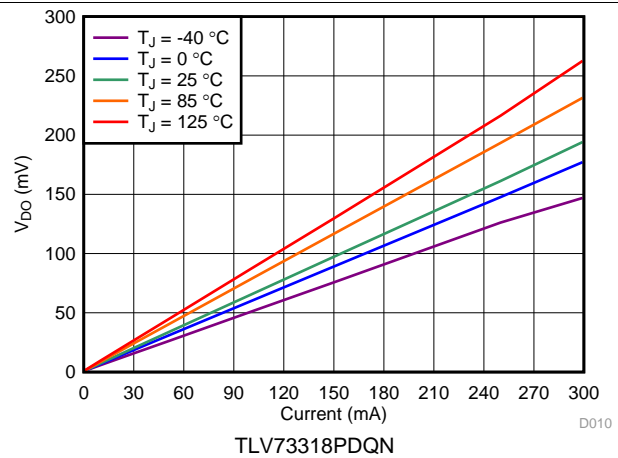

Figure 10. 1.8-V Dropout Voltage vs  $I_{OUT}$  and Temperature

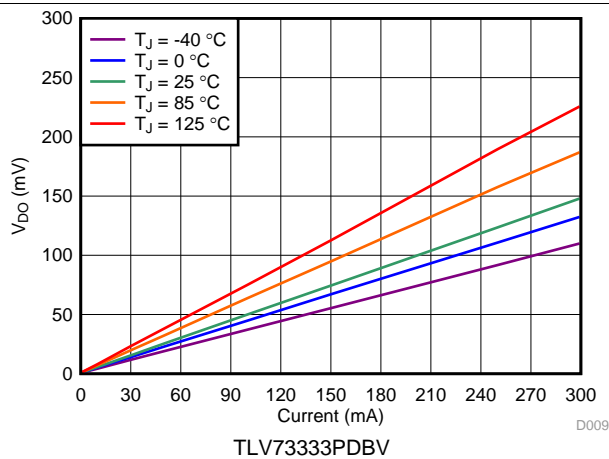

Figure 11. 3.3-V Dropout Voltage vs  $I_{OUT}$  and Temperature

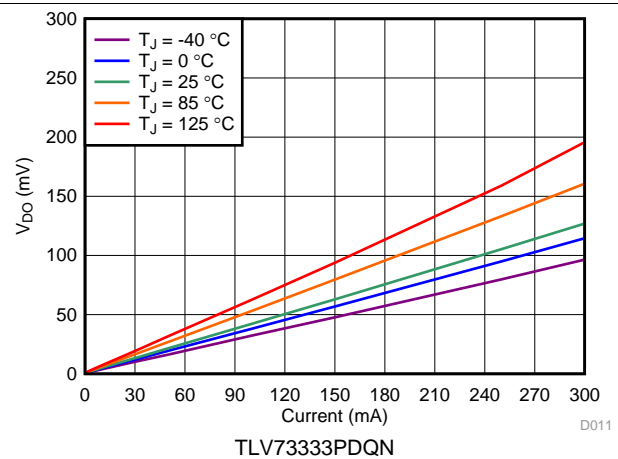

Figure 12. 3.3-V Dropout Voltage vs  $I_{OUT}$  and Temperature



Typical Characteristics (continued)

at operating temperature range ( $T_J = -40^{\circ}\text{C}$  to  $+125^{\circ}\text{C}$ ),  $V_{IN} = V_{OUT(nom)} + 0.5\text{ V}$  or  $2.0\text{ V}$  (whichever is greater),  $I_{OUT} = 1\text{ mA}$ ,  $V_{EN} = V_{IN}$ , and  $C_{IN} = C_{OUT} = 1\text{ }\mu\text{F}$  (unless otherwise noted)

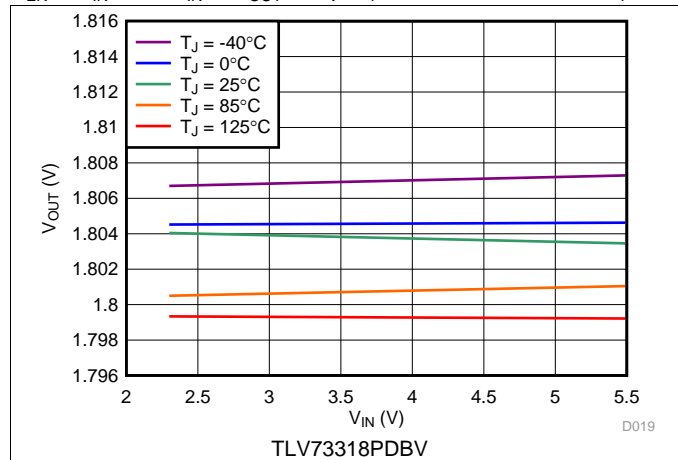

Figure 13. 1.8-V Regulation vs  $V_{IN}$  (Line Regulation) and Temperature

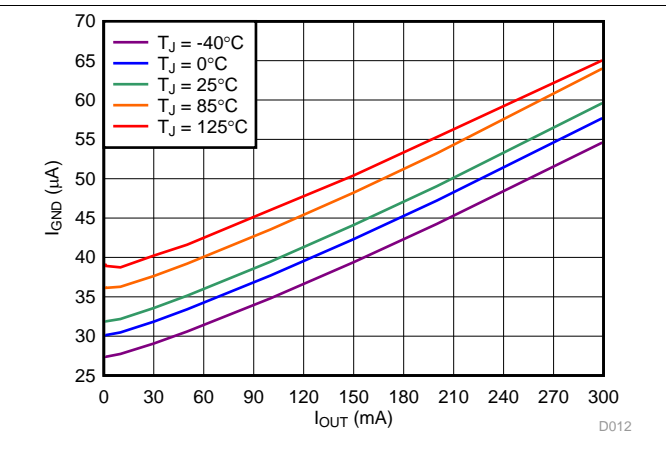

Figure 14. Ground Pin Current vs  $I_{OUT}$  and Temperature

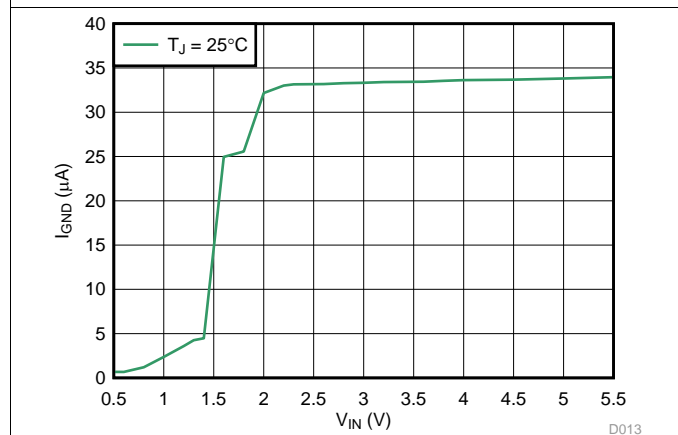

Figure 15. Ground Pin Current vs  $V_{IN}$

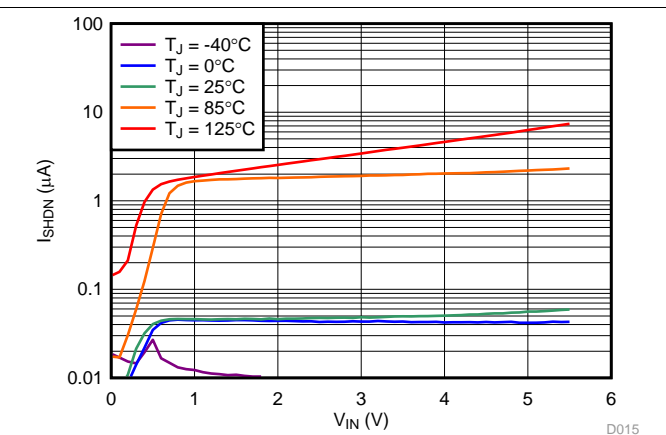

Figure 16. Shutdown Current vs  $V_{IN}$  and Temperature

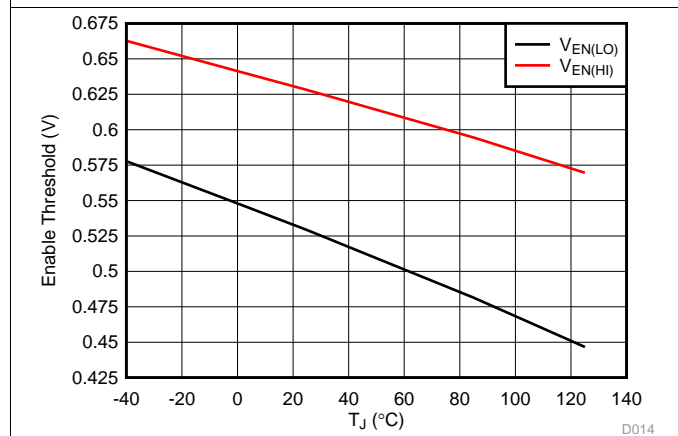

Figure 17. Enable Threshold vs Temperature

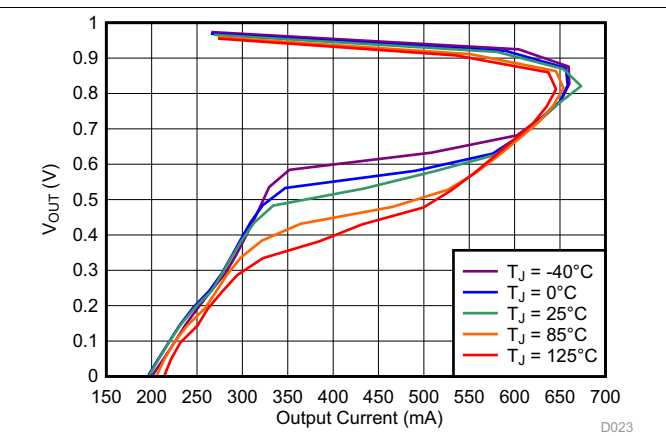

Figure 18. 1.0-V Foldback Current Limit vs  $I_{OUT}$  and Temperature

Typical Characteristics (continued)

at operating temperature range ( $T_J = -40^{\circ}\text{C}$  to  $+125^{\circ}\text{C}$ ),  $V_{IN} = V_{OUT}(\text{nom}) + 0.5\text{ V}$  or  $2.0\text{ V}$  (whichever is greater),  $I_{OUT} = 1\text{ mA}$ ,  $V_{EN} = V_{IN}$ , and  $C_{IN} = C_{OUT} = 1\ \mu\text{F}$  (unless otherwise noted)

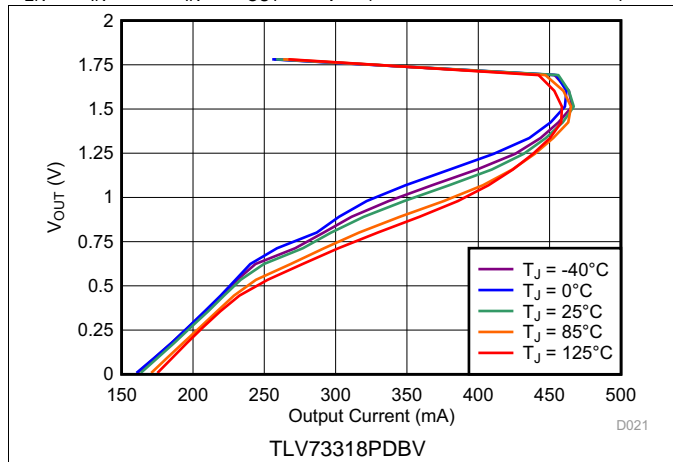

Figure 19. 1.8-V Foldback Current Limit vs  $I_{OUT}$  and Temperature

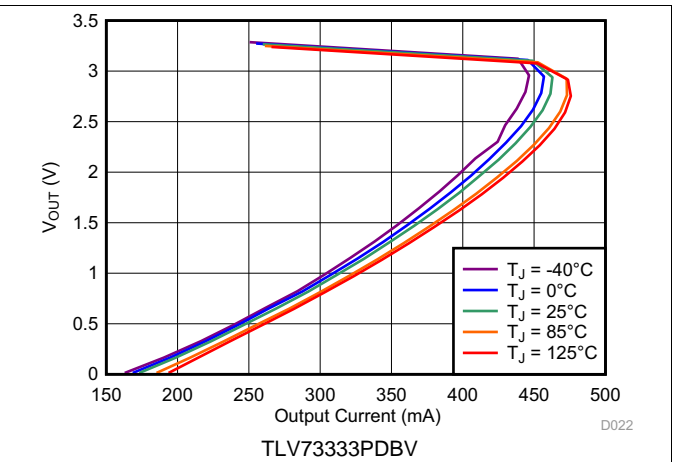

Figure 20. 3.3-V Foldback Current Limit vs  $I_{OUT}$  and Temperature

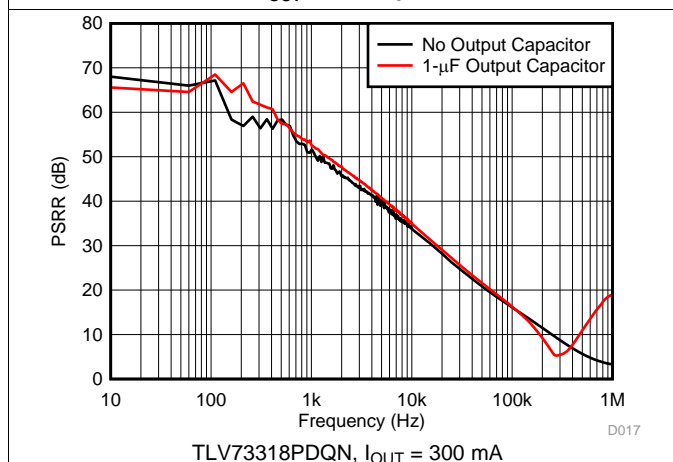

Figure 21. Power-Supply Rejection Ratio vs Frequency

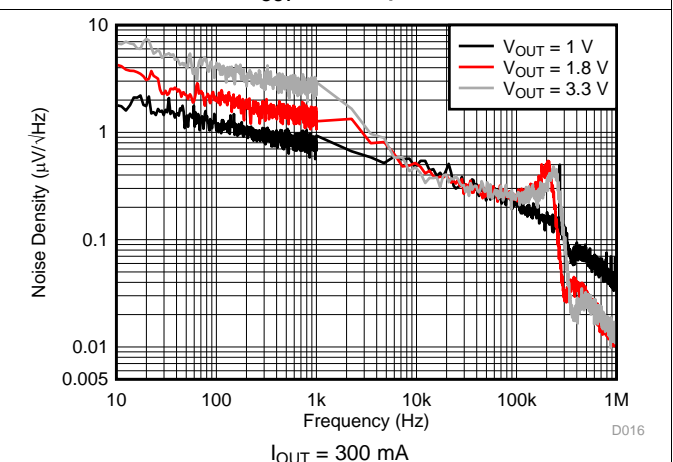

Figure 22. Output Spectral Noise Density

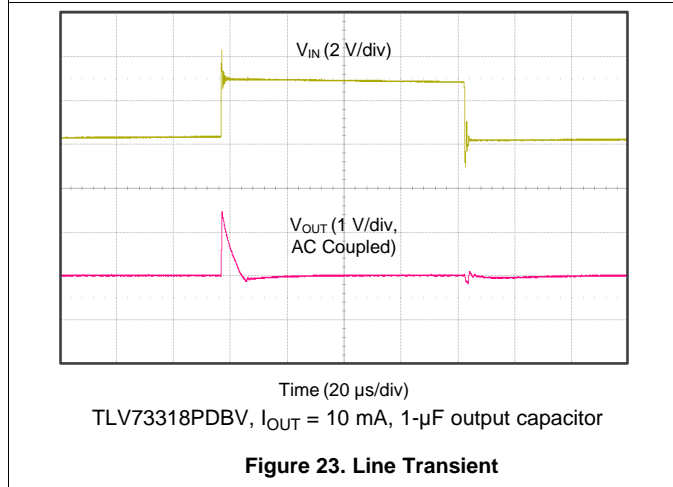

Figure 23. Line Transient

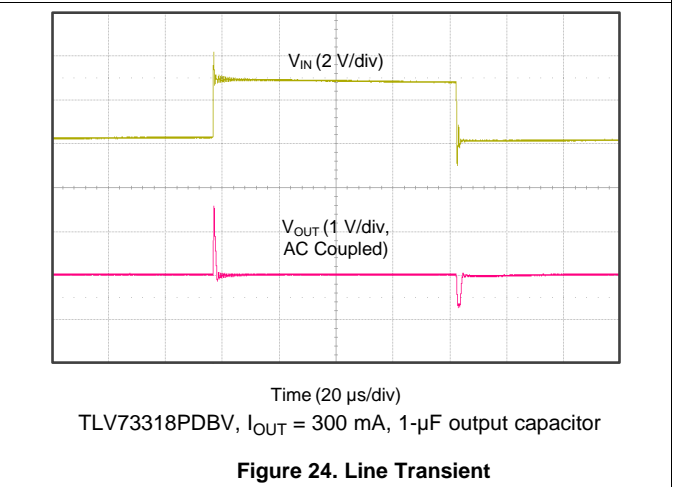
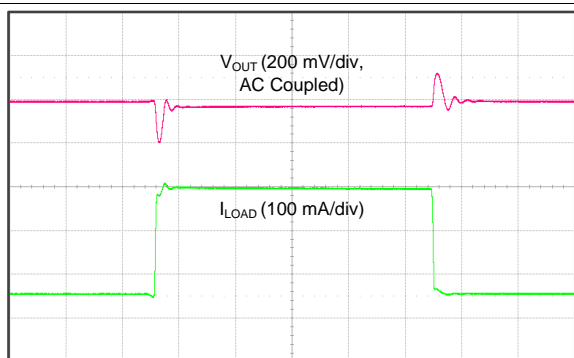

Figure 24. Line Transient

Typical Characteristics (continued)

at operating temperature range ( $T_J = -40^{\circ}\text{C}$  to  $+125^{\circ}\text{C}$ ),  $V_{IN} = V_{OUT}(\text{nom}) + 0.5\text{ V}$  or  $2.0\text{ V}$  (whichever is greater),  $I_{OUT} = 1\text{ mA}$ ,  $V_{EN} = V_{IN}$ , and  $C_{IN} = C_{OUT} = 1\text{ }\mu\text{F}$  (unless otherwise noted)



Time (20  $\mu\text{s}/\text{div}$ )  
TLV73310PDBV,  $V_{IN} = 2.0\text{ V}$ ,  $1\text{-}\mu\text{F}$  output capacitor, output current slew rate =  $0.25\text{ A}/\mu\text{s}$

Figure 25. 1.0-V, 50-mA to 300-mA Load Transient

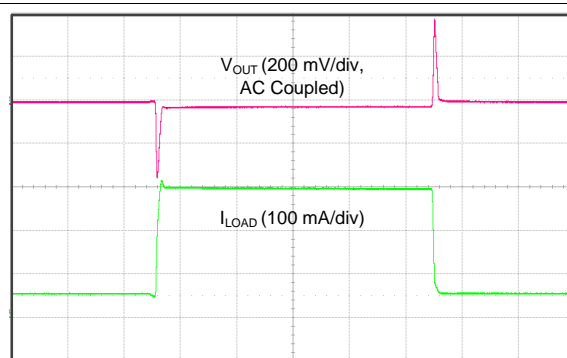

Time (20  $\mu\text{s}/\text{div}$ )  
TLV73310PDBV,  $V_{IN} = 2.0\text{ V}$ , no output capacitor, output current slew rate =  $0.25\text{ A}/\mu\text{s}$

Figure 26. 1.0 V, 50-mA to 300-mA Load Transient

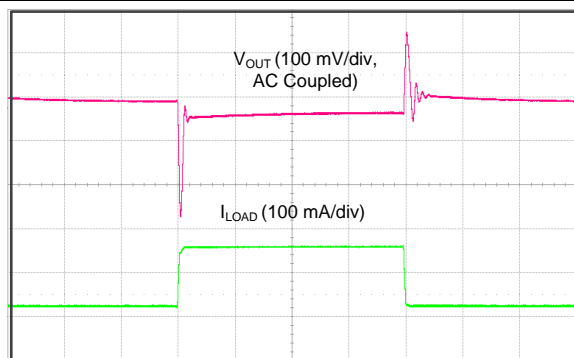

Time (20  $\mu\text{s}/\text{div}$ )  
TLV73333PDBV,  $V_{IN} = 3.8\text{ V}$ ,  $1\text{-}\mu\text{F}$  output capacitor, output current slew rate =  $0.25\text{ A}/\mu\text{s}$

Figure 27. 3.3 V, 50-mA to 300-mA Load Transient

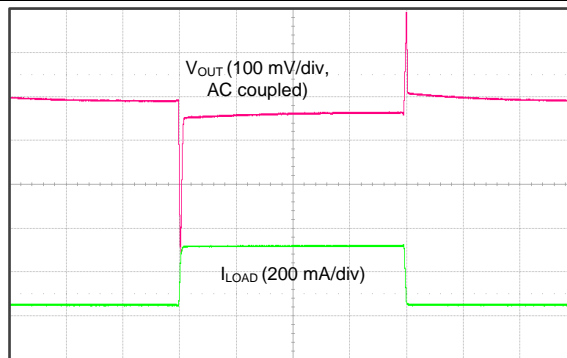

Time (50  $\mu\text{s}/\text{div}$ )  
TLV73333PDBV,  $V_{IN} = 3.8\text{ V}$ , no output capacitor, output current slew rate =  $0.25\text{ A}/\mu\text{s}$

Figure 28. 3.3 V, 50-mA to 300-mA Load Transient

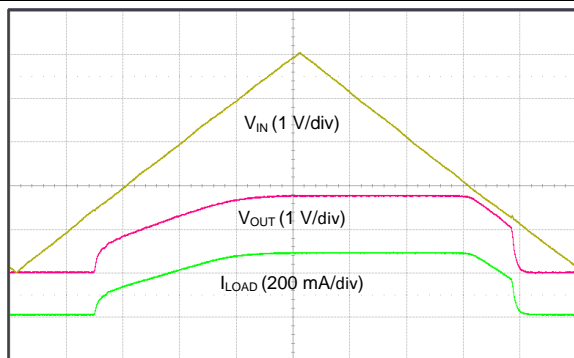

Time (100  $\mu\text{s}/\text{div}$ )  
TLV73318PDBV,  $R_L = 6.2\text{ }\Omega$ ,  $V_{EN} = V_{IN}$ ,  $1\text{-}\mu\text{F}$  output capacitor

Figure 29.  $V_{IN}$  Power-Up and Power-Down

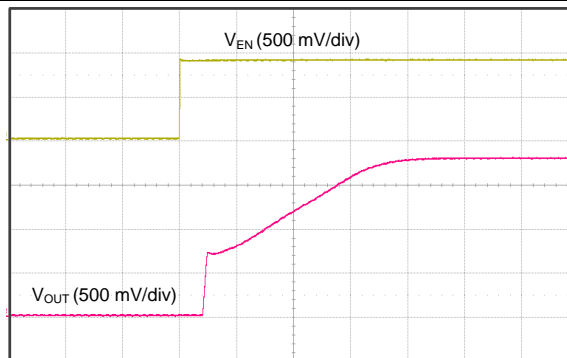

Time (100  $\mu\text{s}/\text{div}$ )  
TLV73318PDBV,  $R_L = 6.2\text{ }\Omega$ ,  $1\text{-}\mu\text{F}$  output capacitor

Figure 30. Startup with EN

### Typical Characteristics (continued)

at operating temperature range ( $T_J = -40^{\circ}\text{C}$  to  $+125^{\circ}\text{C}$ ),  $V_{IN} = V_{OUT}(\text{nom}) + 0.5\text{ V}$  or  $2.0\text{ V}$  (whichever is greater),  $I_{OUT} = 1\text{ mA}$ ,  $V_{EN} = V_{IN}$ , and  $C_{IN} = C_{OUT} = 1\ \mu\text{F}$  (unless otherwise noted)

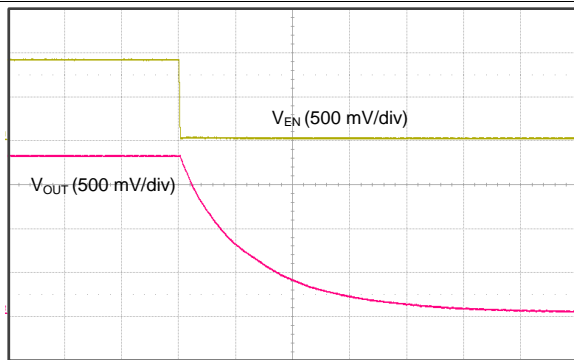

Time (100  $\mu\text{s}/\text{div}$ )

TLV73318PDBV,  $I_{OUT} = 300\text{ mA}$ ,  $1\text{-}\mu\text{F}$  output capacitor

**Figure 31. Shutdown Response with Enable**

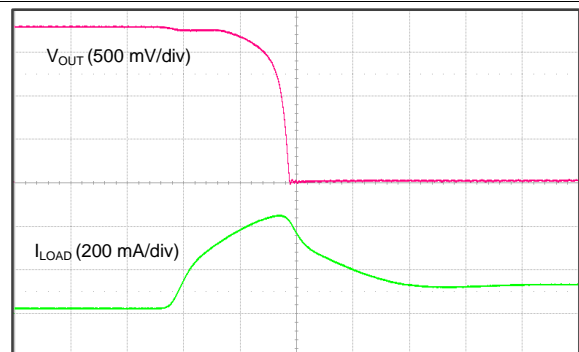

Time (100  $\mu\text{s}/\text{div}$ )

TLV73318PDBV,  $1\text{-}\mu\text{F}$  output capacitor

**Figure 32. Foldback Current Limit Response**

## 7 Detailed Description

### 7.1 Overview

The TLV733 belongs to a new family of next-generation, low-dropout regulators (LDOs). These devices consume low quiescent current and deliver excellent line and load transient performance. These characteristics, combined with low noise, good PSRR with low dropout voltage, make this family of devices ideal for portable consumer applications.

This family of regulators offers foldback current limit, shutdown, and thermal protection. The operating junction temperature for this family of devices is  $-40^{\circ}\text{C}$  to  $125^{\circ}\text{C}$ .

### 7.2 Functional Block Diagram

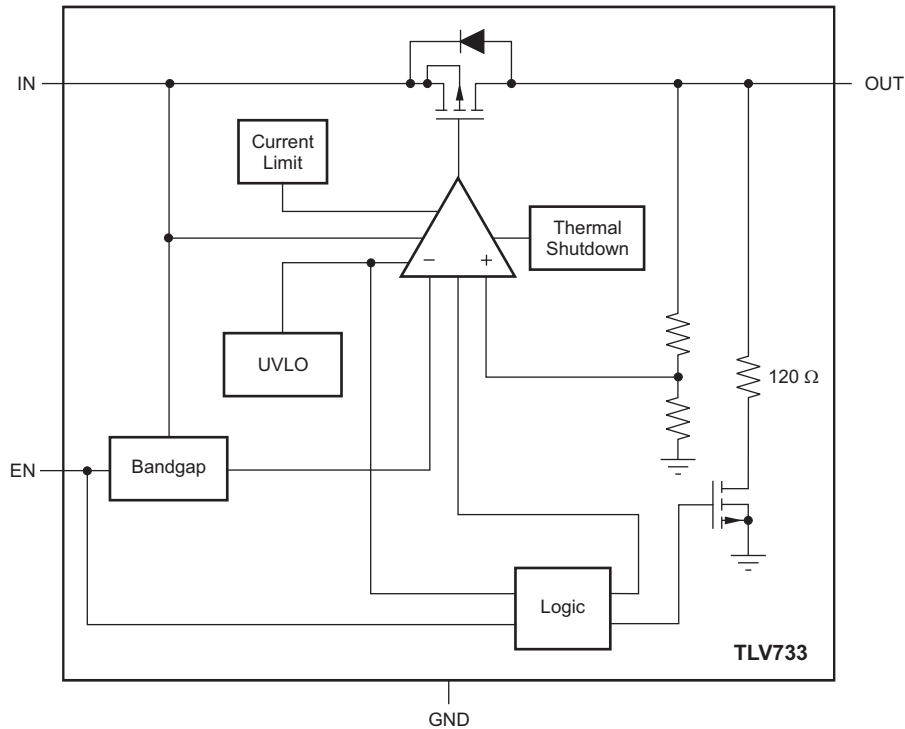

## 7.3 Feature Description

### 7.3.1 Undervoltage Lockout (UVLO)

The TLV733 uses an undervoltage lockout (UVLO) circuit that disables the output until the input voltage is greater than the rising UVLO voltage,  $UVLO_{RISE}$ . This circuit ensures that the device does not exhibit any unpredictable behavior when the supply voltage is lower than the operational range of the internal circuitry. During UVLO disable, the output is connected to ground with a 120- $\Omega$  pulldown resistor.

### 7.3.2 Shutdown and Output Enable

The enable pin (EN) is active high. Enable the device by forcing the EN pin to exceed  $V_{EN(HI)}$ . Turn off the device by forcing the EN pin to drop below  $V_{EN(LO)}$ . If shutdown capability is not required, connect EN to IN. There is no internal pulldown resistor connected to the EN pin.

The TLV733 has an internal pulldown MOSFET that connects a 120- $\Omega$  resistor to ground when the device is disabled. The discharge time after disabling depends on the output capacitance ( $C_{OUT}$ ) and the load resistance ( $R_L$ ) in parallel with the 120- $\Omega$  pulldown resistor. The time constant is calculated in [Equation 1](#):

$$\tau = \frac{120 \cdot R_L}{120 + R_L} \cdot C_{OUT} \quad (1)$$

### 7.3.3 Internal Foldback Current Limit

The TLV733 has an internal foldback current limit that protects the regulator during fault conditions. The current allowed through the device is reduced as the output voltage falls. When the output is shorted, the LDO supplies a typical current of 150 mA. The output voltage is not regulated when the device is in current limit. In this condition, the output voltage is the product of the regulated current and the load resistance. When the device output is shorted, the PMOS pass transistor dissipates power  $[(V_{IN} - V_{OUT}) \times I_{OS}]$  until thermal shutdown is triggered and the device turns off. After the device cools down, the internal thermal shutdown circuit turns the device back on. If the fault condition continues, the device cycles between current limit and thermal shutdown. See the [Thermal Information](#) table for more details.

The foldback current-limit circuit limits the current allowed through the device to current levels lower than the minimum current limit at nominal  $V_{OUT}$  current limit ( $I_{LIM}$ ) during startup. See [Figure 18](#) to [Figure 20](#) for typical foldback current limit values. If the output is loaded by a constant-current load during startup, or if the output voltage is negative when the device is enabled, then the load current demanded by the load may exceed the foldback current limit and the device may not rise to the full output voltage. For constant-current loads, disable the output load until the TLV733 has fully risen to its nominal output voltage.

The TLV733 PMOS pass element has an intrinsic body diode that conducts current when the voltage at the OUT pin exceeds the voltage at the IN pin. Do not force the output voltage to exceed the input voltage because excessively high current may flow through the body diode.

### 7.3.4 Thermal Shutdown

Thermal shutdown protection disables the output when the junction temperature rises to approximately 160°C. Disabling the device eliminates the power dissipated by the device, allowing the device to cool. When the junction temperature cools to approximately 140°C, the output circuitry is again enabled. Depending on power dissipation, thermal resistance, and ambient temperature, the thermal protection circuit may cycle on and off. This cycling limits regulator dissipation, protecting it from damage as a result of overheating.

Activating the thermal shutdown feature usually indicates excessive power dissipation as a result of the product of the  $(V_{IN} - V_{OUT})$  voltage and the load current. For reliable operation, limit junction temperature to 125°C maximum. To estimate the margin of safety in a complete design, increase the ambient temperature until the thermal protection is triggered; use worst-case loads and signal conditions.

The TLV733 internal protection circuitry protects against overload conditions but is not intended to be activated in normal operation. Continuously running the TLV733 into thermal shutdown degrades device reliability.

## 7.4 Device Functional Modes

### 7.4.1 Normal Operation

The device regulates to the nominal output voltage under the following conditions:

- The input voltage has previously exceeded the UVLO rising voltage and has not decreased below the UVLO falling threshold.
- The input voltage is greater than the nominal output voltage added to the dropout voltage.
- The enable voltage has previously exceeded the enable rising threshold voltage and not decreased below the enable falling threshold.
- The output current is less than the current limit.
- The device junction temperature is less than the thermal shutdown temperature.

### 7.4.2 Dropout Operation

If the input voltage is lower than the nominal output voltage plus the specified dropout voltage, but all other conditions are met for normal operation, the device operates in dropout mode. In this condition, the output voltage is the same the input voltage minus the dropout voltage. The transient performance of the device is significantly degraded because the pass device is in a triode state and no longer controls the current through the LDO. Line or load transients in dropout may result in large output voltage deviations.

### 7.4.3 Disabled

The device is disabled under the following conditions:

- The input voltage is less than the UVLO falling voltage, or has not yet exceeded the UVLO rising threshold.
- The enable voltage is less than the enable falling threshold voltage or has not yet exceeded the enable rising threshold.
- The device junction temperature is greater than the thermal shutdown temperature.

When the device is disabled, the active pulldown resistor discharges the output.

Table 1 shows the conditions that lead to the different modes of operation.

**Table 1. Device Functional Mode Comparison**

OPERATING MODE	PARAMETER			
	$V_{IN}$	$V_{EN}$	$I_{OUT}$	$T_J$
Normal mode	$V_{IN} > V_{OUT(nom)} + V_{DO}$ and $V_{IN} > UVLO_{RISE}$	$V_{EN} > V_{EN(HI)}$	$I_{OUT} < I_{LIM}$	$T_J < 160^{\circ}C$
Dropout mode	$UVLO_{RISE} < V_{IN} < V_{OUT(nom)} + V_{DO}$	$V_{EN} > V_{EN(HI)}$	$I_{OUT} < I_{LIM}$	$T_J < 160^{\circ}C$
Disabled mode (any true condition disables the device)	$V_{IN} < UVLO_{FALL}$	$V_{EN} < V_{EN(LO)}$	—	$T_J > 160^{\circ}C$

## 8 Application and Implementation

### NOTE

Information in the following applications sections is not part of the TI component specification, and TI does not warrant its accuracy or completeness. TI's customers are responsible for determining suitability of components for their purposes. Customers should validate and test their design implementation to confirm system functionality.

### 8.1 Application Information

#### 8.1.1 Input and Output Capacitor Selection

The TLV733 uses an advanced internal control loop to obtain stable operation both with and without the use of input or output capacitors. Dynamic performance is improved with the use of an output capacitor, and may be improved with an input capacitor. An output capacitance of 0.1  $\mu\text{F}$  or larger generally provides good dynamic response. Use X5R- and X7R-type ceramic capacitors because these capacitors have minimal variation in value and equivalent series resistance (ESR) over temperature.

Although an input capacitor is not required for stability, increased output impedance from the input supply may compromise the performance of the TLV733. Good analog design practice is to connect a 0.1- $\mu\text{F}$  to 1- $\mu\text{F}$  capacitor from IN to GND. This capacitor counteracts reactive input sources and improves transient response, input ripple, and PSRR. Use an input capacitor if the source impedance is greater than 0.5  $\Omega$ . Use a higher-value capacitor if large, fast, rise-time load transients are anticipated, or if the device is located several inches from the input power source.

Figure 33 shows the transient performance improvements with an external 1- $\mu\text{F}$  capacitor on the output versus no output capacitor. The data in this figure are taken with an increasing load step from 50 mA to 300 mA, and the peak output voltage deviation (load transient response) is measured. For low output current slew rates, ( $< 0.1 \text{ A}/\mu\text{s}$ ), the transient performance of the device is similar with or without an output capacitor. As the current slew rate is increased, the peak voltage deviation is significantly increased. For loads that exhibit fast current slew rates above 0.1  $\text{A}/\mu\text{s}$ , use an output capacitor. For best performance, the maximum recommended output capacitance is 100  $\mu\text{F}$ .

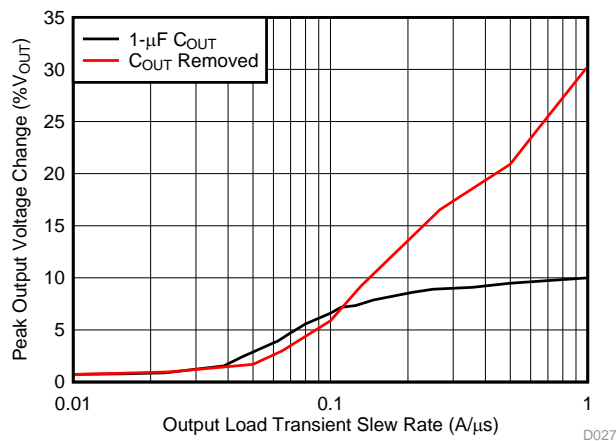

TLV73333PDBV, output current stepped from 50 mA to 300 mA, output voltage change measured at positive  $di/dt$

**Figure 33. Output Voltage Deviation vs Load Step Slew Rate**

Some applications benefit from the removal of the output capacitor. In addition to space and cost savings, the removal of the output capacitor lowers inrush current as a result of eliminating the required current flow into the output capacitor upon startup. In these cases, take care to ensure that the load is tolerant of the additional output voltage deviations.



## Application Information (continued)

### 8.1.2 Dropout Voltage

The TLV733 uses a PMOS pass transistor to achieve low dropout. When  $(V_{IN} - V_{OUT})$  is less than the dropout voltage ( $V_{DO}$ ), the PMOS pass device is in the linear region of operation and the input-to-output resistance is the  $R_{DS(ON)}$  of the PMOS pass element.  $V_{DO}$  scales approximately with output current because the PMOS device behaves like a resistor in dropout mode. As with any linear regulator, PSRR and transient response degrade as  $(V_{IN} - V_{OUT})$  approaches dropout operation. See [Figure 7](#) to [Figure 12](#) for typical dropout values.

### 8.1.3 Power Dissipation

The ability to remove heat from the die is different for each package type, presenting different considerations in the printed circuit board (PCB) layout. The PCB area around the device that is free of other components moves the heat from the device to ambient air. Performance data for JEDEC high-K boards are given in the [Thermal Information](#) table. Using heavier copper increases the effectiveness in removing heat from the device. The addition of plated through-holes to heat-dissipating layers also improves heatsink effectiveness.

Power dissipation ( $P_D$ ) depends on input voltage and load conditions.  $P_D$  is equal to the product of the output current and voltage drop across the output pass element, as shown in [Equation 2](#).

$$P_D = (V_{IN} - V_{OUT}) \times I_{OUT} \quad (2)$$

[Figure 34](#) shows the maximum ambient temperature versus the power dissipation of the TLV733 in the DQN and DBV packages. This figure assumes the device is soldered on JEDEC standard high-K layout with no airflow over the board. Actual board thermal impedances vary widely. If the application requires high power dissipation, having a thorough understanding of the board temperature and thermal impedances is helpful to make sure the TLV733 does not operate continuously above a junction temperature of 125°C.

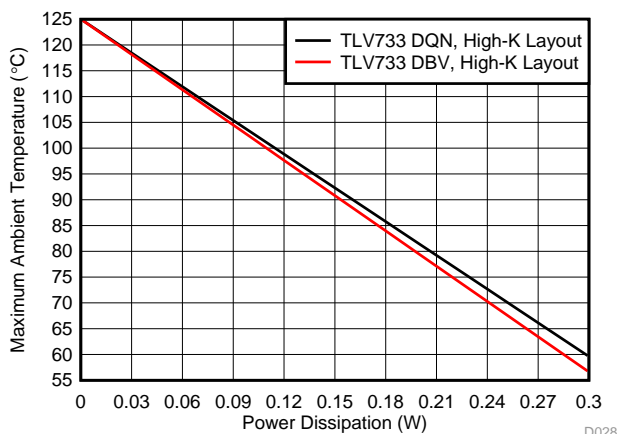

TLV733, high-K layout

**Figure 34. Maximum Ambient Temperature vs Device Power Dissipation**

## 8.2 Typical Applications

### 8.2.1 DC-DC Converter Post Regulation

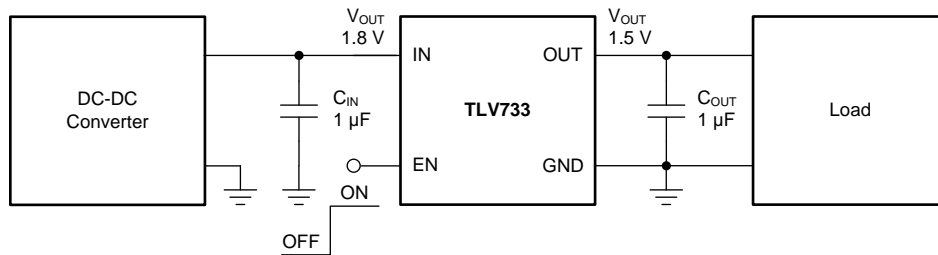

Figure 35. DC-DC Converter Post Regulation

#### 8.2.1.1 Design Requirements

Table 2. Design Parameters

PARAMETER	DESIGN REQUIREMENT
Input voltage	1.8 V, ±5%
Output voltage	1.5 V, ±1%
Output current	200-mA dc, 300-mA peak
Output voltage transient deviation	< 10%, 1-A/μs load step from 50 mA to 200 mA
Maximum ambient temperature	85°C

#### 8.2.1.2 Design Considerations

Input and output capacitors are required to achieve the output voltage transient requirements. Capacitance values of 1 μF are selected to give the maximum output capacitance in a small, low-cost package.

Figure 7 shows the 1.2-V option dropout voltage. Given that dropout voltages are higher for lower output-voltage options, and given that the 1.2-V option dropout voltage is typically less than 300 mV at 125°C, then the 1.5-V option dropout voltage is typically less than 300 mV at 125°C.

Verify that the maximum junction temperature is not exceeded by referring to Figure 34.

#### 8.2.1.3 Application Curve

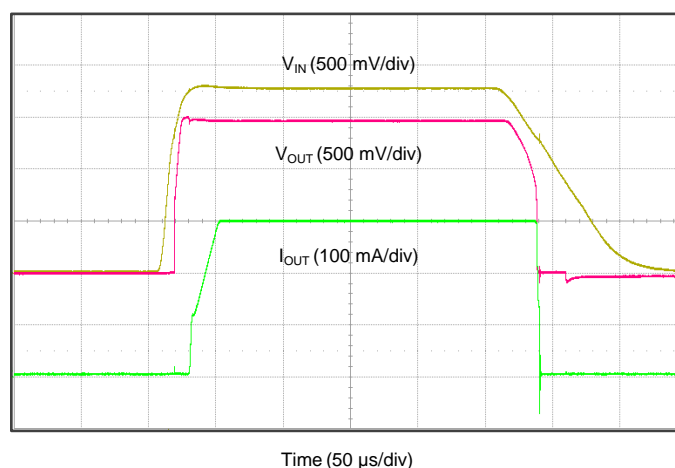

Figure 36. 1.8-V to 1.5-V Regulation at 300 mA

### 8.2.2 Capacitor-Free Operation from Battery Input Supply

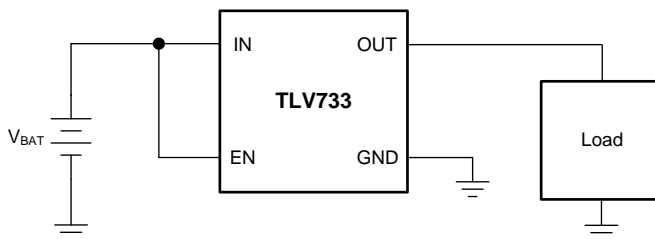

Figure 37. Capacitor-Free Operation from Battery Input Supply

#### 8.2.2.1 Design Requirements

Table 3. Design Parameters

PARAMETER	DESIGN REQUIREMENT
Input voltage	3.0 V to 1.8 V (two 1.5-V batteries)
Output voltage	1.0 V, ±1%
Input current	200 mA, maximum
Output load	100-mA dc
Maximum ambient temperature	70°C

#### 8.2.2.2 Design Considerations

An input capacitor is not required for this design because of the low impedance connection directly to the battery. No output capacitor allows for the minimal possible inrush current during startup, ensuring the 200-mA maximum input current is not exceeded.

Verify that the maximum junction temperature is not exceeded by referring to [Figure 34](#).

#### 8.2.2.3 Application Curve

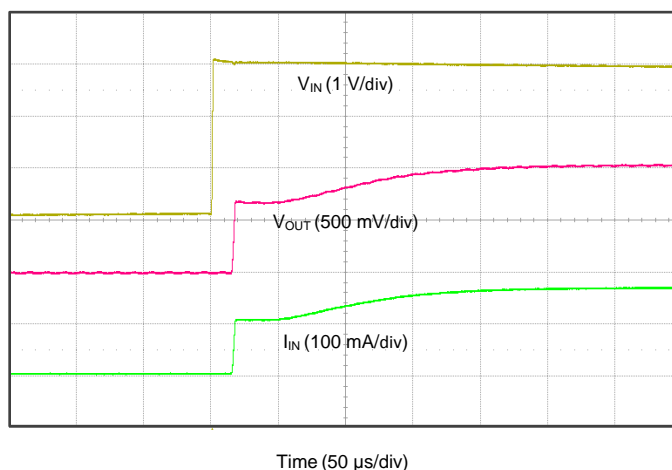

Figure 38. No Inrush Startup, 3.0-V to 1.0-V Regulation

## 9 Power Supply Recommendations

Connect a low output impedance power supply directly to the IN pin of the TLV733. Inductive impedances between the input supply and the IN pin can create significant voltage excursions at the IN pin during startup or load transient events. If inductive impedances are unavoidable, use an input capacitor.

## 10 Layout

### 10.1 Layout Guidelines

- Place input and output capacitors as close to the device as possible.
- Use copper planes for device connections, in order to optimize thermal performance.
- Place thermal vias around the device to distribute the heat.
- Do not place a thermal via directly beneath the thermal pad of the DQN package. A via can wick solder or solder paste away from the thermal pad joint during the soldering process, leading to a compromised solder joint on the thermal pad.

### 10.2 Layout Examples

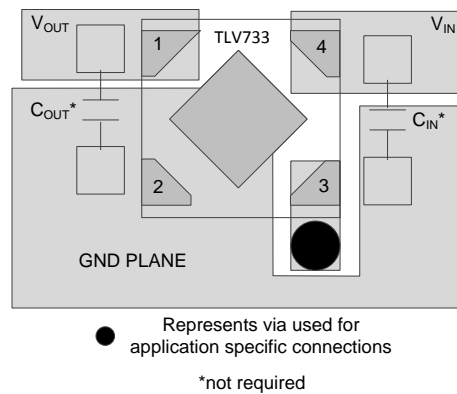

**Figure 39. Layout Example for the DQN Package**

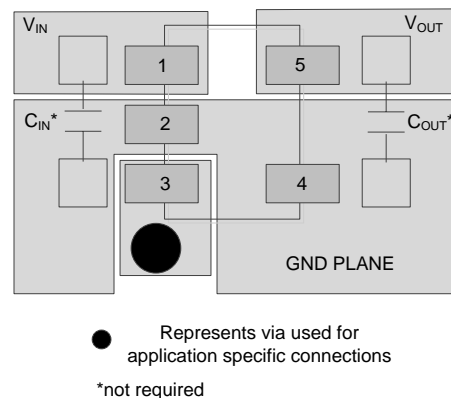

**Figure 40. Layout Example for the DBV Package**

## 11 器件和文档支持

### 11.1 器件支持

#### 11.1.1 开发支持

##### 11.1.1.1 评估模块

评估模块 (EVM) 可与 TLV733 配套使用, 帮助评估初始电路性能。TLV73312PEVM-643 评估模块 (和相关的用户指南) 可在德州仪器 (TI) 网站上的产品文件夹中获取, 也可直接从 [TI 网上商店](#) 购买。

#### 11.1.2 器件命名规则

表 4. 器件命名规则<sup>(1)(2)</sup>

产品	V <sub>OUT</sub>
TLV733xx(x)Pyyy(z)	<p><b>xx(x)</b> 为标称输出电压。对于分辨率为 100mV 的输出电压, 订货编号中使用两位数字; 否则, 使用三位数字 (例如, 28 = 2.8V; 125 = 1.25V)。</p> <p><b>P</b> 表示有源输出放电功能。TLV733 系列的所有成员在被禁用时都可以使输出进行有源放电。</p> <p><b>yyy</b> 为封装标识符。</p> <p><b>z</b> 为封装数量。R 表示卷 (3000 片), T 表示带 (250 片)。</p> <p><b>(3)</b> 表示替代卷带方向。<b>3</b> 表示引脚 1 位于第 3 象限中。请参阅“封装材料信息”附录, 获取更多信息。</p>

(1) 要获得最新的封装和订货信息, 请参阅本文档末尾的封装选项附录, 或者访问器件产品文件夹 ([www.ti.com.cn](http://www.ti.com.cn))。

(2) 可提供 1.0V 至 3.3V 范围内的输出电压 (以 50mV 为单位增量)。更多详细信息及可用性, 请联系制造商。

### 11.2 文档支持

#### 11.2.1 相关文档

德州仪器 (TI), [《TLV73312PDQN-643 评估模块》用户指南](#)

#### 11.3 接收文档更新通知

要接收文档更新通知, 请导航至 [TI.com.cn](http://TI.com.cn) 上的器件产品文件夹。单击右上角的 [通知我](#) 进行注册, 即可每周接收产品信息更改摘要。有关更改的详细信息, 请查看任何已修订文档中包含的修订历史记录。

#### 11.4 社区资源

The following links connect to TI community resources. Linked contents are provided "AS IS" by the respective contributors. They do not constitute TI specifications and do not necessarily reflect TI's views; see TI's [Terms of Use](#).

**TI E2E™ Online Community** *TI's Engineer-to-Engineer (E2E) Community*. Created to foster collaboration among engineers. At [e2e.ti.com](http://e2e.ti.com), you can ask questions, share knowledge, explore ideas and help solve problems with fellow engineers.

**Design Support** *TI's Design Support* Quickly find helpful E2E forums along with design support tools and contact information for technical support.

#### 11.5 商标

E2E is a trademark of Texas Instruments.

All other trademarks are the property of their respective owners.

#### 11.6 静电放电警告



ESD 可能会损坏该集成电路。德州仪器 (TI) 建议通过适当的预防措施处理所有集成电路。如果不遵守正确的处理措施和安装程序, 可能会损坏集成电路。

ESD 的损坏小至导致微小的性能降级, 大至整个器件故障。精密的集成电路可能更容易受到损坏, 这是因为非常细微的参数更改都可能会导致器件与其发布的规格不相符。

## 11.7 Glossary

[SLYZ022](#) — *TI Glossary*.

This glossary lists and explains terms, acronyms, and definitions.

## 12 机械、封装和可订购信息

以下页面包含机械、封装和可订购信息。这些信息是指定器件的最新可用数据。数据如有变更，恕不另行通知，且不会对此文档进行修订。如需获取此数据表的浏览器版本，请查阅左侧的导航栏。

**DQN0004A**

**PACKAGE OUTLINE**  
**X2SON - 0.4 mm max height**

PLASTIC SMALL OUTLINE - NO LEAD

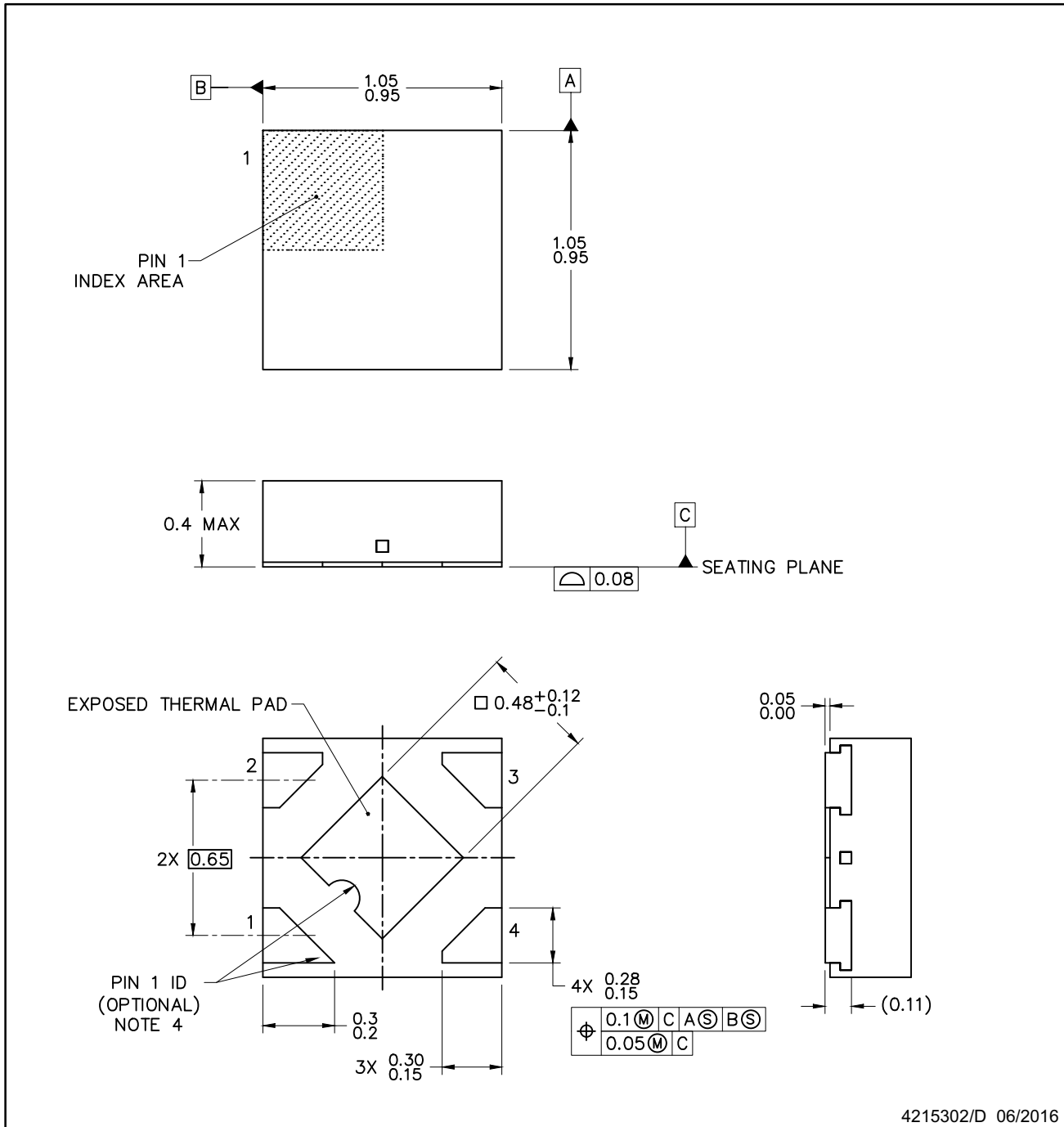

NOTES:

1. All linear dimensions are in millimeters. Any dimensions in parenthesis are for reference only. Dimensioning and tolerancing per ASME Y14.5M.
2. This drawing is subject to change without notice.
3. The package thermal pad must be soldered to the printed circuit board for thermal and mechanical performance.
4. Features may not exist. Recommend use of pin 1 marking on top of package for orientation purposes.



## EXAMPLE BOARD LAYOUT

DQN0004A

X2SON - 0.4 mm max height

PLASTIC SMALL OUTLINE - NO LEAD

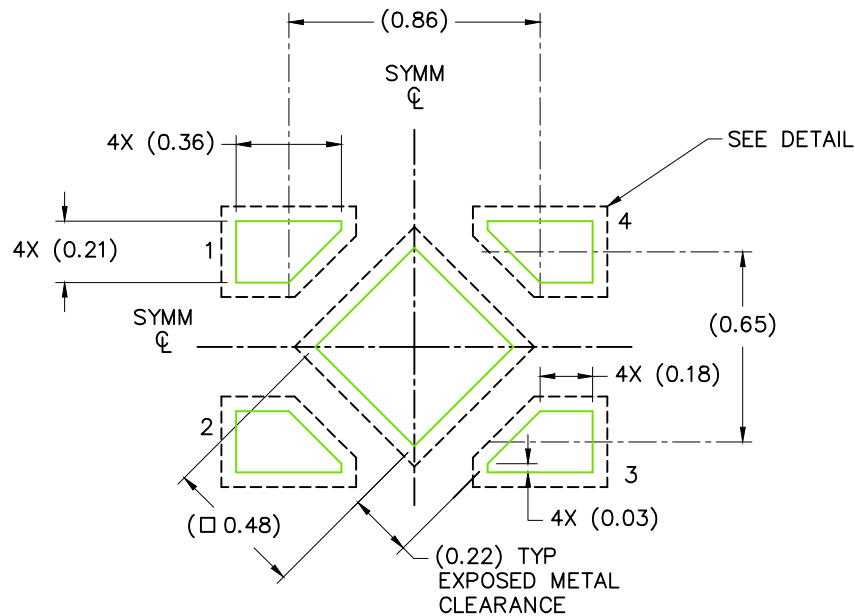

LAND PATTERN EXAMPLE  
SCALE: 40X

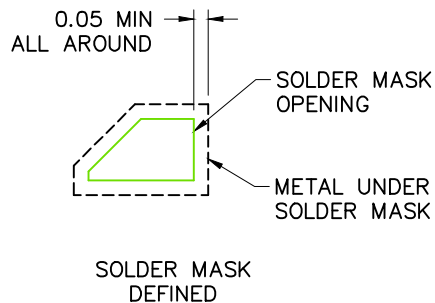

SOLDER MASK DEFINED  
SOLDER MASK DETAIL

4215302/D 06/2016

NOTES: (continued)

5. This package is designed to be soldered to a thermal pad on the board. For more information, see Texas Instruments literature number SLUA271 ([www.ti.com/lit/sluea271](http://www.ti.com/lit/sluea271)).
6. If any vias are implemented, it is recommended that vias under paste be filled, plugged or tented.

## EXAMPLE STENCIL DESIGN

### DQN0004A

### X2SON - 0.4 mm max height

PLASTIC SMALL OUTLINE - NO LEAD

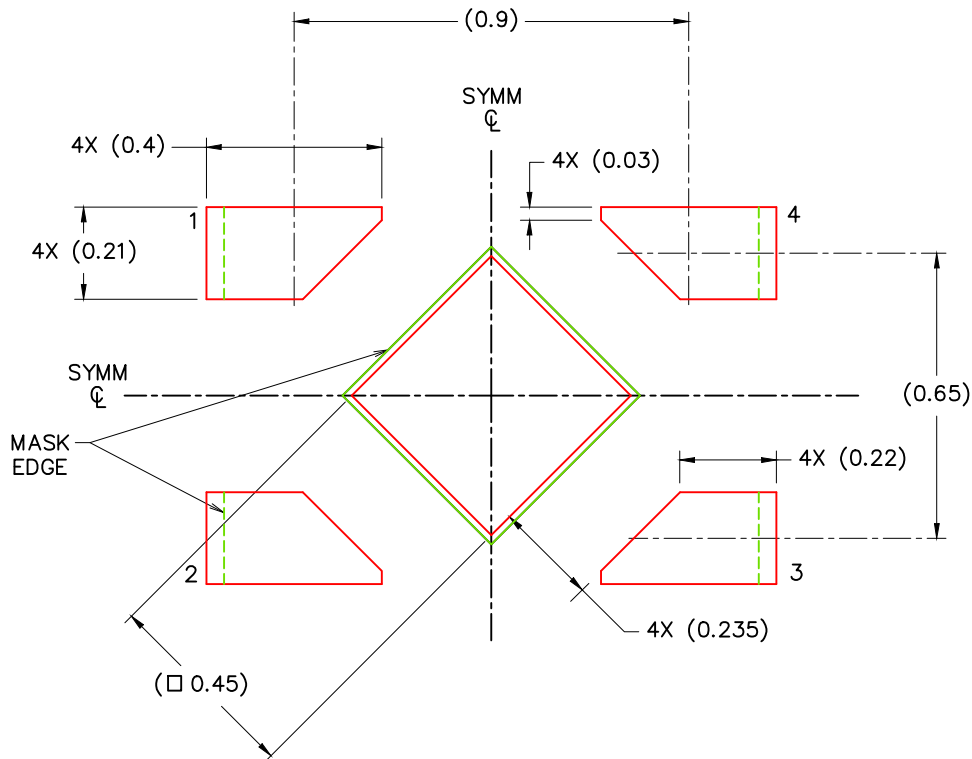

SOLDER PASTE EXAMPLE  
 BASED ON 0.075 – 0.1mm THICK STENCIL

EXPOSED PAD  
 88% PRINTED SOLDER COVERAGE BY AREA  
 SCALE: 60X

4215302/D 06/2016

NOTES: (continued)

7. Laser cutting apertures with trapezoidal walls and rounded corners may offer better paste release. IPC-7525 may have alternate design recommendations.

**PACKAGING INFORMATION**

Orderable Device	Status (1)	Package Type	Package Drawing	Pins	Package Qty	Eco Plan (2)	Lead finish/ Ball material (6)	MSL Peak Temp (3)	Op Temp (°C)	Device Marking (4/5)	Samples
TLV73310PDBVR	ACTIVE	SOT-23	DBV	5	3000	RoHS & Green	NIPDAU   SN	Level-1-260C-UNLIM	-40 to 125	VCCQ	<a href="#">Samples</a>
TLV73310PDBVT	ACTIVE	SOT-23	DBV	5	250	RoHS & Green	NIPDAU   SN	Level-1-260C-UNLIM	-40 to 125	VCCQ	<a href="#">Samples</a>
TLV73310PDQNR	ACTIVE	X2SON	DQN	4	3000	RoHS & Green	NIPDAU	Level-1-260C-UNLIM	-40 to 125	FG	<a href="#">Samples</a>
TLV73310PDQNT	ACTIVE	X2SON	DQN	4	250	RoHS & Green	NIPDAU	Level-1-260C-UNLIM	-40 to 125	FG	<a href="#">Samples</a>
TLV73311PDBVR	ACTIVE	SOT-23	DBV	5	3000	RoHS & Green	NIPDAU   SN	Level-1-260C-UNLIM	-40 to 125	ZBLW	<a href="#">Samples</a>
TLV73311PDBVT	ACTIVE	SOT-23	DBV	5	250	RoHS & Green	NIPDAU   SN	Level-1-260C-UNLIM	-40 to 125	ZBLW	<a href="#">Samples</a>
TLV73311PDQNR	ACTIVE	X2SON	DQN	4	3000	RoHS & Green	NIPDAU	Level-1-260C-UNLIM	-40 to 125	GR	<a href="#">Samples</a>
TLV73311PDQNT	ACTIVE	X2SON	DQN	4	250	RoHS & Green	NIPDAU	Level-1-260C-UNLIM	-40 to 125	GR	<a href="#">Samples</a>
TLV73312PDBVR	ACTIVE	SOT-23	DBV	5	3000	RoHS & Green	NIPDAU   SN	Level-1-260C-UNLIM	-40 to 125	VCDQ	<a href="#">Samples</a>
TLV73312PDBVT	ACTIVE	SOT-23	DBV	5	250	RoHS & Green	NIPDAU   SN	Level-1-260C-UNLIM	-40 to 125	VCDQ	<a href="#">Samples</a>
TLV73312PDQNR	ACTIVE	X2SON	DQN	4	3000	RoHS & Green	NIPDAU	Level-1-260C-UNLIM	-40 to 125	FI	<a href="#">Samples</a>
TLV73312PDQNR3	ACTIVE	X2SON	DQN	4	3000	RoHS & Green	NIPDAU	Level-1-260C-UNLIM	-40 to 125	FI	<a href="#">Samples</a>
TLV73312PDQNT	ACTIVE	X2SON	DQN	4	250	RoHS & Green	NIPDAU	Level-1-260C-UNLIM	-40 to 125	FI	<a href="#">Samples</a>
TLV73315PDBVR	ACTIVE	SOT-23	DBV	5	3000	RoHS & Green	NIPDAU   SN	Level-1-260C-UNLIM	-40 to 125	VCFQ	<a href="#">Samples</a>
TLV73315PDBVT	ACTIVE	SOT-23	DBV	5	250	RoHS & Green	NIPDAU   SN	Level-1-260C-UNLIM	-40 to 125	VCFQ	<a href="#">Samples</a>
TLV73315PDQNR	ACTIVE	X2SON	DQN	4	3000	RoHS & Green	NIPDAU	Level-1-260C-UNLIM	-40 to 125	FJ	<a href="#">Samples</a>
TLV73315PDQNR3	ACTIVE	X2SON	DQN	4	3000	RoHS & Green	NIPDAU	Level-1-260C-UNLIM	-40 to 125	FJ	<a href="#">Samples</a>
TLV73315PDQNT	ACTIVE	X2SON	DQN	4	250	RoHS & Green	NIPDAU	Level-1-260C-UNLIM	-40 to 125	FJ	<a href="#">Samples</a>
TLV73318PDBVR	ACTIVE	SOT-23	DBV	5	3000	RoHS & Green	NIPDAU   SN	Level-1-260C-UNLIM	-40 to 125	VCGQ	<a href="#">Samples</a>
TLV73318PDBVT	ACTIVE	SOT-23	DBV	5	250	RoHS & Green	NIPDAU   SN	Level-1-260C-UNLIM	-40 to 125	VCGQ	<a href="#">Samples</a>

Orderable Device	Status (1)	Package Type	Package Drawing	Pins	Package Qty	Eco Plan (2)	Lead finish/ Ball material (6)	MSL Peak Temp (3)	Op Temp (°C)	Device Marking (4/5)	Samples
TLV73318PDQNR	ACTIVE	X2SON	DQN	4	3000	RoHS & Green	NIPDAU	Level-1-260C-UNLIM	-40 to 125	FK	<a href="#">Samples</a>
TLV73318PDQNR3	ACTIVE	X2SON	DQN	4	3000	RoHS & Green	NIPDAU	Level-1-260C-UNLIM	-40 to 125	FK	<a href="#">Samples</a>
TLV73318PDQNT	ACTIVE	X2SON	DQN	4	250	RoHS & Green	NIPDAU	Level-1-260C-UNLIM	-40 to 125	FK	<a href="#">Samples</a>
TLV73325PDBVR	ACTIVE	SOT-23	DBV	5	3000	RoHS & Green	NIPDAU   SN	Level-1-260C-UNLIM	-40 to 125	VCHQ	<a href="#">Samples</a>
TLV73325PDBVT	ACTIVE	SOT-23	DBV	5	250	RoHS & Green	NIPDAU   SN	Level-1-260C-UNLIM	-40 to 125	VCHQ	<a href="#">Samples</a>
TLV73325PDQNR	ACTIVE	X2SON	DQN	4	3000	RoHS & Green	NIPDAU	Level-1-260C-UNLIM	-40 to 125	FL	<a href="#">Samples</a>
TLV73325PDQNT	ACTIVE	X2SON	DQN	4	250	RoHS & Green	NIPDAU	Level-1-260C-UNLIM	-40 to 125	FL	<a href="#">Samples</a>
TLV733285PDBVR	ACTIVE	SOT-23	DBV	5	3000	RoHS & Green	NIPDAU   SN	Level-1-260C-UNLIM	-40 to 125	ZDRW	<a href="#">Samples</a>
TLV733285PDBVT	ACTIVE	SOT-23	DBV	5	250	RoHS & Green	NIPDAU   SN	Level-1-260C-UNLIM	-40 to 125	ZDRW	<a href="#">Samples</a>
TLV733285PDQNR	ACTIVE	X2SON	DQN	4	3000	RoHS & Green	NIPDAU	Level-1-260C-UNLIM	-40 to 125	GZ	<a href="#">Samples</a>
TLV733285PDQNT	ACTIVE	X2SON	DQN	4	250	RoHS & Green	NIPDAU	Level-1-260C-UNLIM	-40 to 125	GZ	<a href="#">Samples</a>
TLV73328PDBVR	ACTIVE	SOT-23	DBV	5	3000	RoHS & Green	NIPDAU   SN	Level-1-260C-UNLIM	-40 to 125	ZDQW	<a href="#">Samples</a>
TLV73328PDBVT	ACTIVE	SOT-23	DBV	5	250	RoHS & Green	NIPDAU   SN	Level-1-260C-UNLIM	-40 to 125	ZDQW	<a href="#">Samples</a>
TLV73328PDQNR	ACTIVE	X2SON	DQN	4	3000	RoHS & Green	NIPDAU	Level-1-260C-UNLIM	-40 to 125	GY	<a href="#">Samples</a>
TLV73328PDQNR3	ACTIVE	X2SON	DQN	4	3000	RoHS & Green	NIPDAU	Level-1-260C-UNLIM	-40 to 125	GY	<a href="#">Samples</a>
TLV73328PDQNT	ACTIVE	X2SON	DQN	4	250	RoHS & Green	NIPDAU	Level-1-260C-UNLIM	-40 to 125	GY	<a href="#">Samples</a>
TLV73330PDBVR	ACTIVE	SOT-23	DBV	5	3000	RoHS & Green	NIPDAU   SN	Level-1-260C-UNLIM	-40 to 125	ZDMW	<a href="#">Samples</a>
TLV73330PDBVT	ACTIVE	SOT-23	DBV	5	250	RoHS & Green	NIPDAU   SN	Level-1-260C-UNLIM	-40 to 125	ZDMW	<a href="#">Samples</a>
TLV73330PDQNR	ACTIVE	X2SON	DQN	4	3000	RoHS & Green	NIPDAU	Level-1-260C-UNLIM	-40 to 125	GW	<a href="#">Samples</a>
TLV73330PDQNT	ACTIVE	X2SON	DQN	4	250	RoHS & Green	NIPDAU	Level-1-260C-UNLIM	-40 to 125	GW	<a href="#">Samples</a>
TLV73333PDBVR	ACTIVE	SOT-23	DBV	5	3000	RoHS & Green	NIPDAU   SN	Level-1-260C-UNLIM	-40 to 125	VCIQ	<a href="#">Samples</a>

Orderable Device	Status (1)	Package Type	Package Drawing	Pins	Package Qty	Eco Plan (2)	Lead finish/ Ball material (6)	MSL Peak Temp (3)	Op Temp (°C)	Device Marking (4/5)	Samples
TLV73333PDBVT	ACTIVE	SOT-23	DBV	5	250	RoHS & Green	NIPDAU   SN	Level-1-260C-UNLIM	-40 to 125	VCIQ	<a href="#">Samples</a>
TLV73333PDQNR	ACTIVE	X2SON	DQN	4	3000	RoHS & Green	NIPDAU	Level-1-260C-UNLIM	-40 to 125	FM	<a href="#">Samples</a>
TLV73333PDQNT	ACTIVE	X2SON	DQN	4	250	RoHS & Green	NIPDAU	Level-1-260C-UNLIM	-40 to 125	FM	<a href="#">Samples</a>

(1) The marketing status values are defined as follows:

**ACTIVE:** Product device recommended for new designs.

**LIFEBUY:** TI has announced that the device will be discontinued, and a lifetime-buy period is in effect.

**NRND:** Not recommended for new designs. Device is in production to support existing customers, but TI does not recommend using this part in a new design.

**PREVIEW:** Device has been announced but is not in production. Samples may or may not be available.

**OBSOLETE:** TI has discontinued the production of the device.

(2) **RoHS:** TI defines "RoHS" to mean semiconductor products that are compliant with the current EU RoHS requirements for all 10 RoHS substances, including the requirement that RoHS substance do not exceed 0.1% by weight in homogeneous materials. Where designed to be soldered at high temperatures, "RoHS" products are suitable for use in specified lead-free processes. TI may reference these types of products as "Pb-Free".

**RoHS Exempt:** TI defines "RoHS Exempt" to mean products that contain lead but are compliant with EU RoHS pursuant to a specific EU RoHS exemption.

**Green:** TI defines "Green" to mean the content of Chlorine (Cl) and Bromine (Br) based flame retardants meet JS709B low halogen requirements of <=1000ppm threshold. Antimony trioxide based flame retardants must also meet the <=1000ppm threshold requirement.

(3) MSL, Peak Temp. - The Moisture Sensitivity Level rating according to the JEDEC industry standard classifications, and peak solder temperature.

(4) There may be additional marking, which relates to the logo, the lot trace code information, or the environmental category on the device.

(5) Multiple Device Markings will be inside parentheses. Only one Device Marking contained in parentheses and separated by a "-" will appear on a device. If a line is indented then it is a continuation of the previous line and the two combined represent the entire Device Marking for that device.

(6) Lead finish/Ball material - Orderable Devices may have multiple material finish options. Finish options are separated by a vertical ruled line. Lead finish/Ball material values may wrap to two lines if the finish value exceeds the maximum column width.

**Important Information and Disclaimer:**The information provided on this page represents TI's knowledge and belief as of the date that it is provided. TI bases its knowledge and belief on information provided by third parties, and makes no representation or warranty as to the accuracy of such information. Efforts are underway to better integrate information from third parties. TI has taken and continues to take reasonable steps to provide representative and accurate information but may not have conducted destructive testing or chemical analysis on incoming materials and chemicals. TI and TI suppliers consider certain information to be proprietary, and thus CAS numbers and other limited information may not be available for release.

In no event shall TI's liability arising out of such information exceed the total purchase price of the TI part(s) at issue in this document sold by TI to Customer on an annual basis.

**OTHER QUALIFIED VERSIONS OF TLV733P :**

- Automotive : [TLV733P-Q1](#)

NOTE: Qualified Version Definitions:

- Automotive - Q100 devices qualified for high-reliability automotive applications targeting zero defects

**TAPE AND REEL INFORMATION**

**QUADRANT ASSIGNMENTS FOR PIN 1 ORIENTATION IN TAPE**

\*All dimensions are nominal

Device	Package Type	Package Drawing	Pins	SPQ	Reel Diameter (mm)	Reel Width W1 (mm)	A0 (mm)	B0 (mm)	K0 (mm)	P1 (mm)	W (mm)	Pin1 Quadrant
TLV73310PDBVR	SOT-23	DBV	5	3000	178.0	9.0	3.23	3.17	1.37	4.0	8.0	Q3
TLV73310PDBVR	SOT-23	DBV	5	3000	180.0	8.4	3.2	3.2	1.4	4.0	8.0	Q3
TLV73310PDBVT	SOT-23	DBV	5	250	178.0	8.4	3.23	3.17	1.37	4.0	8.0	Q3
TLV73310PDBVT	SOT-23	DBV	5	250	180.0	8.4	3.2	3.2	1.4	4.0	8.0	Q3
TLV73310PDQNR	X2SON	DQN	4	3000	180.0	9.5	1.16	1.16	0.5	4.0	8.0	Q2
TLV73310PDQNT	X2SON	DQN	4	250	180.0	9.5	1.16	1.16	0.5	4.0	8.0	Q2
TLV73311PDBVR	SOT-23	DBV	5	3000	178.0	9.0	3.23	3.17	1.37	4.0	8.0	Q3
TLV73311PDBVT	SOT-23	DBV	5	250	178.0	8.4	3.23	3.17	1.37	4.0	8.0	Q3
TLV73311PDQNR	X2SON	DQN	4	3000	180.0	9.5	1.16	1.16	0.5	4.0	8.0	Q2
TLV73311PDQNT	X2SON	DQN	4	250	180.0	9.5	1.16	1.16	0.5	4.0	8.0	Q2
TLV73312PDBVR	SOT-23	DBV	5	3000	178.0	9.0	3.23	3.17	1.37	4.0	8.0	Q3
TLV73312PDBVT	SOT-23	DBV	5	250	178.0	8.4	3.23	3.17	1.37	4.0	8.0	Q3
TLV73312PDQNR	X2SON	DQN	4	3000	180.0	9.5	1.16	1.16	0.5	4.0	8.0	Q2
TLV73312PDQNR3	X2SON	DQN	4	3000	180.0	9.5	1.16	1.16	0.5	4.0	8.0	Q3
TLV73312PDQNT	X2SON	DQN	4	250	180.0	9.5	1.16	1.16	0.5	4.0	8.0	Q2
TLV73315PDBVR	SOT-23	DBV	5	3000	180.0	8.4	3.2	3.2	1.4	4.0	8.0	Q3

Device	Package Type	Package Drawing	Pins	SPQ	Reel Diameter (mm)	Reel Width W1 (mm)	A0 (mm)	B0 (mm)	K0 (mm)	P1 (mm)	W (mm)	Pin1 Quadrant
TLV73315PDBVT	SOT-23	DBV	5	250	180.0	8.4	3.2	3.2	1.4	4.0	8.0	Q3
TLV73315PDQNR	X2SON	DQN	4	3000	180.0	9.5	1.16	1.16	0.5	4.0	8.0	Q2
TLV73315PDQNR3	X2SON	DQN	4	3000	180.0	9.5	1.16	1.16	0.5	4.0	8.0	Q3
TLV73315PDQNT	X2SON	DQN	4	250	180.0	9.5	1.16	1.16	0.5	4.0	8.0	Q2
TLV73318PDBVR	SOT-23	DBV	5	3000	178.0	9.0	3.23	3.17	1.37	4.0	8.0	Q3
TLV73318PDBVT	SOT-23	DBV	5	250	178.0	8.4	3.23	3.17	1.37	4.0	8.0	Q3
TLV73318PDQNR	X2SON	DQN	4	3000	180.0	9.5	1.16	1.16	0.5	4.0	8.0	Q2
TLV73318PDQNR3	X2SON	DQN	4	3000	180.0	9.5	1.16	1.16	0.5	4.0	8.0	Q3
TLV73318PDQNT	X2SON	DQN	4	250	180.0	9.5	1.16	1.16	0.5	4.0	8.0	Q2
TLV73325PDBVR	SOT-23	DBV	5	3000	178.0	9.0	3.23	3.17	1.37	4.0	8.0	Q3
TLV73325PDBVT	SOT-23	DBV	5	250	178.0	8.4	3.23	3.17	1.37	4.0	8.0	Q3
TLV73325PDQNR	X2SON	DQN	4	3000	180.0	9.5	1.16	1.16	0.5	4.0	8.0	Q2
TLV73325PDQNT	X2SON	DQN	4	250	180.0	9.5	1.16	1.16	0.5	4.0	8.0	Q2
TLV733285PDBVR	SOT-23	DBV	5	3000	180.0	8.4	3.2	3.2	1.4	4.0	8.0	Q3
TLV733285PDBVT	SOT-23	DBV	5	250	180.0	8.4	3.2	3.2	1.4	4.0	8.0	Q3
TLV733285PDQNR	X2SON	DQN	4	3000	180.0	9.5	1.16	1.16	0.5	4.0	8.0	Q2
TLV733285PDQNT	X2SON	DQN	4	250	180.0	9.5	1.16	1.16	0.5	4.0	8.0	Q2
TLV73328PDBVR	SOT-23	DBV	5	3000	178.0	9.0	3.23	3.17	1.37	4.0	8.0	Q3
TLV73328PDBVT	SOT-23	DBV	5	250	178.0	9.0	3.23	3.17	1.37	4.0	8.0	Q3
TLV73328PDQNR	X2SON	DQN	4	3000	180.0	9.5	1.16	1.16	0.5	4.0	8.0	Q2
TLV73328PDQNR3	X2SON	DQN	4	3000	180.0	9.5	1.16	1.16	0.5	4.0	8.0	Q3
TLV73328PDQNT	X2SON	DQN	4	250	180.0	9.5	1.16	1.16	0.5	4.0	8.0	Q2
TLV73330PDBVR	SOT-23	DBV	5	3000	180.0	8.4	3.2	3.2	1.4	4.0	8.0	Q3
TLV73330PDBVT	SOT-23	DBV	5	250	180.0	8.4	3.2	3.2	1.4	4.0	8.0	Q3
TLV73330PDQNR	X2SON	DQN	4	3000	180.0	9.5	1.16	1.16	0.5	4.0	8.0	Q2
TLV73330PDQNT	X2SON	DQN	4	250	180.0	9.5	1.16	1.16	0.5	4.0	8.0	Q2
TLV73333PDBVR	SOT-23	DBV	5	3000	178.0	9.0	3.23	3.17	1.37	4.0	8.0	Q3
TLV73333PDBVT	SOT-23	DBV	5	250	178.0	8.4	3.23	3.17	1.37	4.0	8.0	Q3
TLV73333PDQNR	X2SON	DQN	4	3000	180.0	9.5	1.16	1.16	0.5	4.0	8.0	Q2
TLV73333PDQNT	X2SON	DQN	4	250	180.0	9.5	1.16	1.16	0.5	4.0	8.0	Q2



**TAPE AND REEL BOX DIMENSIONS**

\*All dimensions are nominal

Device	Package Type	Package Drawing	Pins	SPQ	Length (mm)	Width (mm)	Height (mm)
TLV73310PDBVR	SOT-23	DBV	5	3000	180.0	180.0	18.0
TLV73310PDBVT	SOT-23	DBV	5	250	180.0	180.0	18.0
TLV73310PDQNR	X2SON	DQN	4	3000	184.0	184.0	19.0
TLV73310PDQNT	X2SON	DQN	4	250	184.0	184.0	19.0
TLV73311PDBVR	SOT-23	DBV	5	3000	210.0	185.0	35.0
TLV73311PDBVT	SOT-23	DBV	5	250	210.0	185.0	35.0
TLV73311PDQNR	X2SON	DQN	4	3000	184.0	184.0	19.0
TLV73311PDQNT	X2SON	DQN	4	250	184.0	184.0	19.0
TLV73312PDBVR	SOT-23	DBV	5	3000	180.0	180.0	18.0
TLV73312PDBVT	SOT-23	DBV	5	250	180.0	180.0	18.0
TLV73312PDQNR	X2SON	DQN	4	3000	184.0	184.0	19.0
TLV73312PDQNR3	X2SON	DQN	4	3000	184.0	184.0	19.0
TLV73312PDQNT	X2SON	DQN	4	250	184.0	184.0	19.0
TLV73315PDBVR	SOT-23	DBV	5	3000	210.0	185.0	35.0
TLV73315PDBVT	SOT-23	DBV	5	250	210.0	185.0	35.0
TLV73315PDQNR	X2SON	DQN	4	3000	184.0	184.0	19.0

Device	Package Type	Package Drawing	Pins	SPQ	Length (mm)	Width (mm)	Height (mm)
TLV73315PDQNR3	X2SON	DQN	4	3000	184.0	184.0	19.0
TLV73315PDQNT	X2SON	DQN	4	250	184.0	184.0	19.0
TLV73318PDBVR	SOT-23	DBV	5	3000	180.0	180.0	18.0
TLV73318PDBVT	SOT-23	DBV	5	250	180.0	180.0	18.0
TLV73318PDQNR	X2SON	DQN	4	3000	184.0	184.0	19.0
TLV73318PDQNR3	X2SON	DQN	4	3000	184.0	184.0	19.0
TLV73318PDQNT	X2SON	DQN	4	250	184.0	184.0	19.0
TLV73325PDBVR	SOT-23	DBV	5	3000	180.0	180.0	18.0
TLV73325PDBVT	SOT-23	DBV	5	250	180.0	180.0	18.0
TLV73325PDQNR	X2SON	DQN	4	3000	184.0	184.0	19.0
TLV73325PDQNT	X2SON	DQN	4	250	184.0	184.0	19.0
TLV733285PDBVR	SOT-23	DBV	5	3000	210.0	185.0	35.0
TLV733285PDBVT	SOT-23	DBV	5	250	210.0	185.0	35.0
TLV733285PDQNR	X2SON	DQN	4	3000	184.0	184.0	19.0
TLV733285PDQNT	X2SON	DQN	4	250	184.0	184.0	19.0
TLV73328PDBVR	SOT-23	DBV	5	3000	180.0	180.0	18.0
TLV73328PDBVT	SOT-23	DBV	5	250	180.0	180.0	18.0
TLV73328PDQNR	X2SON	DQN	4	3000	184.0	184.0	19.0
TLV73328PDQNR3	X2SON	DQN	4	3000	184.0	184.0	19.0
TLV73328PDQNT	X2SON	DQN	4	250	184.0	184.0	19.0
TLV73330PDBVR	SOT-23	DBV	5	3000	210.0	185.0	35.0
TLV73330PDBVT	SOT-23	DBV	5	250	210.0	185.0	35.0
TLV73330PDQNR	X2SON	DQN	4	3000	184.0	184.0	19.0
TLV73330PDQNT	X2SON	DQN	4	250	184.0	184.0	19.0
TLV73333PDBVR	SOT-23	DBV	5	3000	180.0	180.0	18.0
TLV73333PDBVT	SOT-23	DBV	5	250	180.0	180.0	18.0
TLV73333PDQNR	X2SON	DQN	4	3000	184.0	184.0	19.0
TLV73333PDQNT	X2SON	DQN	4	250	184.0	184.0	19.0



DBV0005A

# PACKAGE OUTLINE

SOT-23 - 1.45 mm max height

SMALL OUTLINE TRANSISTOR

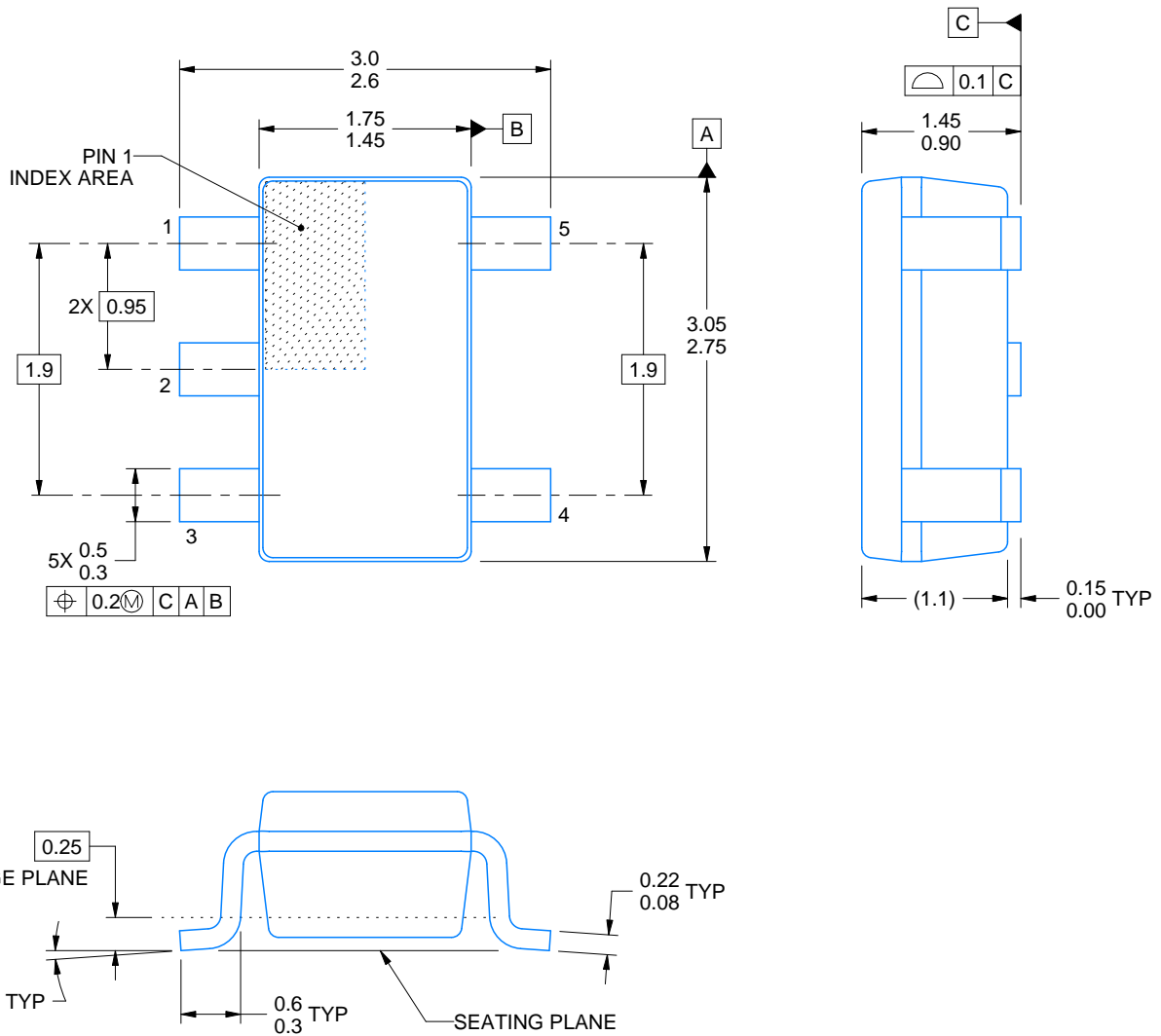

4214839/F 06/2021

NOTES:

1. All linear dimensions are in millimeters. Any dimensions in parenthesis are for reference only. Dimensioning and tolerancing per ASME Y14.5M.
2. This drawing is subject to change without notice.
3. Reference JEDEC MO-178.
4. Body dimensions do not include mold flash, protrusions, or gate burrs. Mold flash, protrusions, or gate burrs shall not exceed 0.25 mm per side.

# EXAMPLE BOARD LAYOUT

DBV0005A

SOT-23 - 1.45 mm max height

SMALL OUTLINE TRANSISTOR



LAND PATTERN EXAMPLE  
EXPOSED METAL SHOWN  
SCALE:15X



SOLDER MASK DETAILS

4214839/F 06/2021

NOTES: (continued)

- 5. Publication IPC-7351 may have alternate designs.
- 6. Solder mask tolerances between and around signal pads can vary based on board fabrication site.

# EXAMPLE STENCIL DESIGN

DBV0005A

SOT-23 - 1.45 mm max height

SMALL OUTLINE TRANSISTOR



SOLDER PASTE EXAMPLE  
BASED ON 0.125 mm THICK STENCIL  
SCALE:15X

4214839/F 06/2021

NOTES: (continued)

7. Laser cutting apertures with trapezoidal walls and rounded corners may offer better paste release. IPC-7525 may have alternate design recommendations.
8. Board assembly site may have different recommendations for stencil design.

## 重要声明和免责声明

TI“按原样”提供技术和可靠性数据（包括数据表）、设计资源（包括参考设计）、应用或其他设计建议、网络工具、安全信息和其他资源，不保证没有瑕疵且不做任何明示或暗示的担保，包括但不限于对适销性、某特定用途方面的适用性或不侵犯任何第三方知识产权的暗示担保。

这些资源可供使用 TI 产品进行设计的熟练开发人员使用。您将自行承担以下全部责任：(1) 针对您的应用选择合适的 TI 产品，(2) 设计、验证并测试您的应用，(3) 确保您的应用满足相应标准以及任何其他功能安全、信息安全、监管或其他要求。

这些资源如有变更，恕不另行通知。TI 授权您仅可将这些资源用于研发本资源所述的 TI 产品的应用。严禁对这些资源进行其他复制或展示。您无权使用任何其他 TI 知识产权或任何第三方知识产权。您应全额赔偿因在这些资源的使用中对 TI 及其代表造成的任何索赔、损害、成本、损失和债务，TI 对此概不负责。

TI 提供的产品受 [TI 的销售条款](#) 或 [ti.com](#) 上其他适用条款/TI 产品随附的其他适用条款的约束。TI 提供这些资源并不会扩展或以其他方式更改 TI 针对 TI 产品发布的适用的担保或担保免责声明。

TI 反对并拒绝您可能提出的任何其他或不同的条款。

邮寄地址：Texas Instruments, Post Office Box 655303, Dallas, Texas 75265

Copyright © 2023，德州仪器 (TI) 公司

## X-ON Electronics

Largest Supplier of Electrical and Electronic Components

*Click to view similar products for [LDO Voltage Regulators](#) category:*

*Click to view products by [Texas Instruments](#) manufacturer:*

Other Similar products are found below :

[AP7363-SP-13](#) [NCV8664CST33T3G](#) [L79M05TL-E](#) [AP7362-HA-7](#) [PT7M8202B12TA5EX](#) [TCR3DF185,LM\(CT](#) [TLF4949EJ](#)  
[NCP4687DH15T1G](#) [NCV8703MX30TCG](#) [LP2951CN](#) [NCV4269CPD50R2G](#) [AP7315-25W5-7](#) [NCV47411PAAJR2G](#) [AP2111H-1.2TRG1](#)  
[ZLDO1117QK50TC](#) [AZ1117ID-ADJTRG1](#) [NCV4263-2CPD50R2G](#) [NCP114BMX075TCG](#) [MC33269T-3.5G](#) [TLE4471GXT](#) [AP7315-33SA-](#)  
[7](#) [NCV4266-2CST33T3G](#) [NCP715SQ15T2G](#) [NCV8623MN-50R2G](#) [NCV563SQ18T1G](#) [NCV8664CDT33RKG](#) [NCV4299CD250R2G](#)  
[NCP715MX30TBG](#) [NCV8702MX25TCG](#) [TLE7270-2E](#) [NCV562SQ25T1G](#) [AP2213D-3.3TRG1](#) [AP2202K-2.6TRE1](#)  
[NCV8170BMX300TCG](#) [NCV8152MX300180TCG](#) [NCP700CMT45TBG](#) [AP7315-33W5-7](#) [NCP154MX180300TAG](#) [AP2113AMTR-G1](#)  
[NJW4104U2-33A-TE1](#) [MP2013AGG-5-P](#) [NCV8775CDT50RKG](#) [NJM2878F3-45-TE1](#) [S-19214B00A-V5T2U7](#) [S-19214B50A-V5T2U7](#) [S-](#)  
[19213B50A-V5T2U7](#) [S-19214BC0A-E8T1U7\\*1](#) [S-19213B00A-V5T2U7](#) [S-19213B33A-V5T2U7](#) [S-19213BC0A-V5T2U7](#)