

## 采用小尺寸封装的 TLV751 双通道 500mA 高精度可调节 LDO

### 1 特性

- 输入电压范围：1.5V 至 6.0V
- 输出电压范围：
  - 可调节电压范围：0.55V 至 5.5V
  - 固定电压范围：0.65V 至 5.0V
- 低压降：
  - 500mA 时为 130mV（最大值）(3.3  $V_{OUT}$ )
- 高输出精度：1.5%（温度范围内最大值）
- $I_Q$ ：25 $\mu$ A（典型值）
- 内置软启动功能，具有单调  $V_{OUT}$  上升
- 封装：
  - 2mm  $\times$  2mm WSON-10 (DSQ)
- 有源输出放电

### 2 应用

- 微服务器和塔式服务器
- 门窗传感器
- 便携式销售终端 (EPOS)
- 可穿戴健身和活动监测仪
- 扫描仪
- Wi-Fi 接入点
- 通信模块

### 3 说明

TLV751 是一款双通道、可调节的 500mA 低压降 (LDO) 稳压器。该器件采用小型 10 引脚 2mm  $\times$  2mm WSON 封装，具有 25 $\mu$ A 的静态电流，同时提供快速的线路和负载瞬态响应。TLV751 具有 130mV 的低压降，有助于提高总功率效率。

TLV751 具有宽输入和输出电压范围以及出色的输出电流能力，当用于小型印刷电路板 (PCB) 上时，可帮助支持各类应用，如传感器电源、辅助电源轨和具有更低内核电压的现代微控制器。

TLV751 可与小型陶瓷输出电容器搭配使用，从而减小整体解决方案尺寸。精密带隙和误差放大器在整个温度范围内具有高精度，最大值为 1.5%。该器件包括集成的热关断、电流限制、有源输出放电和欠压锁定 (UVLO) 功能。TLV751 的内部过流保护限制功能可在发生短路事件时减少热耗散。

器件信息(1)

器件型号	封装	封装尺寸 (标称值)
TLV751	WSON (10)	2.00mm $\times$ 2.00mm

(1) 如需了解所有可用封装，请参阅数据表末尾的可订购产品附录。

(2) 预览器件。

典型应用

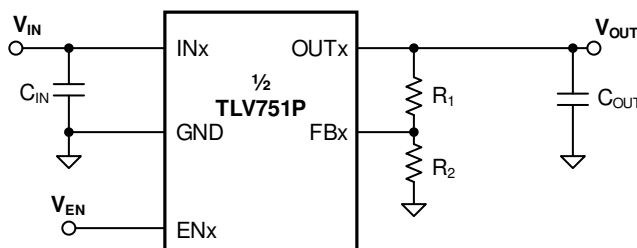

## 目录

<b>1</b>	特性 .....	<b>1</b>	7.4	Device Functional Modes .....	<b>16</b>
<b>2</b>	应用 .....	<b>1</b>	<b>8</b>	<b>Application and Implementation</b> .....	<b>17</b>
<b>3</b>	说明 .....	<b>1</b>	8.1	Application Information .....	<b>17</b>
<b>4</b>	修订历史记录 .....	<b>2</b>	8.2	Typical Application .....	<b>21</b>
<b>5</b>	<b>Pin Configuration and Functions</b> .....	<b>3</b>	<b>9</b>	<b>Power Supply Recommendations</b> .....	<b>23</b>
<b>6</b>	<b>Specifications</b> .....	<b>5</b>	<b>10</b>	<b>Layout</b> .....	<b>23</b>
6.1	Absolute Maximum Ratings .....	<b>5</b>	10.1	Layout Guidelines .....	<b>23</b>
6.2	ESD Ratings .....	<b>5</b>	10.2	Layout Example .....	<b>23</b>
6.3	Recommended Operating Conditions .....	<b>5</b>	<b>11</b>	器件和文档支持 .....	<b>24</b>
6.4	Thermal Information .....	<b>6</b>	11.1	器件支持 .....	<b>24</b>
6.5	Electrical Characteristics .....	<b>6</b>	11.2	接收文档更新通知 .....	<b>24</b>
6.6	Typical Characteristics .....	<b>8</b>	11.3	社区资源 .....	<b>24</b>
<b>7</b>	<b>Detailed Description</b> .....	<b>14</b>	11.4	商标 .....	<b>24</b>
7.1	Overview .....	<b>14</b>	11.5	静电放电警告 .....	<b>24</b>
7.2	Functional Block Diagram .....	<b>14</b>	11.6	Glossary .....	<b>24</b>
7.3	Feature Description .....	<b>14</b>	<b>12</b>	机械、封装和可订购信息 .....	<b>24</b>

## 4 修订历史记录

注：之前版本的页码可能与当前版本有所不同。

### Changes from Original (December 2019) to Revision A

Page

- |   |  |          |
|---|--|----------|
| • | Changed pins 6, 8, 9, and 10 in <i>Pin Configuration and Functions</i> section ..... | <b>3</b> |
|---|--|----------|

## 5 Pin Configuration and Functions

**DSQ Package  
10-Pin Adjustable WSON  
Top View**

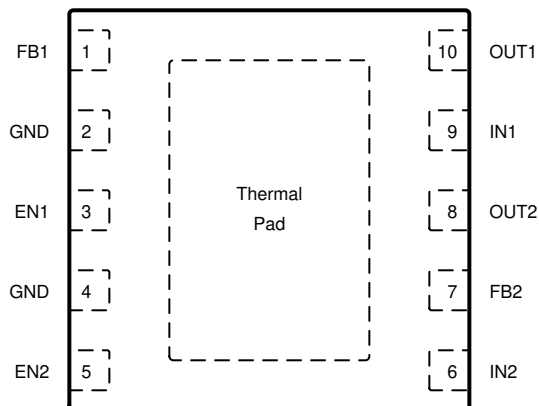

Not to scale

**DSQ Package  
10-Pin Adjustable WSON  
Top View**

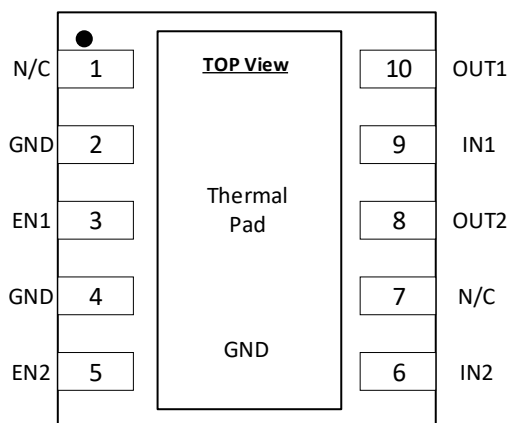

### Pin Functions

PIN		I/O	DESCRIPTION
NAME	DSQ		
EN1	3	Input	Enable pin. Drive EN1 greater than $V_{EN1(HI)}$ to turn on the regulator. Drive EN1 less than $V_{EN1(LO)}$ to put the low-dropout (LDO) regulator into shutdown mode.
EN2	5	Input	Enable pin. Drive EN2 greater than $V_{EN2(HI)}$ to turn on the regulator. Drive EN2 less than $V_{EN2(LO)}$ to put the LDO into shutdown mode.
FB1/ NC	1	—	For the adjustable TLV75101, this pin is used as an input to the control loop error amplifier and is used to set the output voltage of the LDO. For the fixed TLV751xxxxxyy, this is not connected internally.
FB2 / NC	7	—	For the adjustable TLV75101, this pin is used as an input to the control loop error amplifier and is used to set the output voltage of the LDO. For the fixed TLV751xxxxxyy, this is not connected internally.
GND	2, 4	—	Ground pin
IN1	9	Input	Input pin. For best transient response and to minimize input impedance, use the recommended value or larger ceramic capacitor from IN to ground; see the <a href="#">Recommended Operating Conditions</a> table and the <a href="#">Input and Output Capacitor Selection</a> section. Place the input capacitor as close to the output of the device as possible.

**Pin Functions (continued)**

PIN		I/O	DESCRIPTION
NAME	DSQ		
IN2	6	Input	Input pin. For best transient response and to minimize input impedance, use the recommended value or larger ceramic capacitor from IN to ground; see the <a href="#">Recommended Operating Conditions</a> table and the <a href="#">Input and Output Capacitor Selection</a> section. Place the input capacitor as close to the output of the device as possible.
OUT1	10	Output	Regulated output voltage pin. A capacitor is required from OUT to ground for stability. For best transient response, use the nominal recommended value or larger ceramic capacitor from OUT to ground; see the <a href="#">Recommended Operating Conditions</a> table and the <a href="#">Input and Output Capacitor Selection</a> section. Place the output capacitor as close to output of the device as possible.
OUT2	8	Output	Regulated output voltage pin. A capacitor is required from OUT to ground for stability. For best transient response, use the nominal recommended value or larger ceramic capacitor from OUT to ground; see the <a href="#">Recommended Operating Conditions</a> table and the <a href="#">Input and Output Capacitor Selection</a> section. Place the output capacitor as close to output of the device as possible.
Thermal pad		—	Connect the thermal pad to a large area GND plane for improved thermal performance.

## 6 Specifications

### 6.1 Absolute Maximum Ratings

over operating free-air temperature range (unless otherwise noted)<sup>(1)</sup>

		MIN	MAX	UNIT
Voltage	Supply, $V_{IN}$	-0.3	6.5	V
	Enable, $V_{EN}$	-0.3	6.5	
	Feedback, $V_{FB}$	-0.3	2	
Voltage	Output, $V_{OUT}$	-0.3	$V_{IN} + 0.3$ <sup>(2)</sup>	
Temperature	Operating junction, $T_J$	-40	150	°C
	Storage, $T_{stg}$	-65	150	

- (1) Stresses beyond those listed under *Absolute Maximum Ratings* may cause permanent damage to the device. These are stress ratings only, which do not imply functional operation of the device at these or any other conditions beyond those indicated under *Recommended Operating Conditions*. Exposure to absolute-maximum-rated conditions for extended periods may affect device reliability.
- (2) The absolute maximum rating is  $V_{IN} + 0.3V$  or 6.5 V, whichever is smaller.

### 6.2 ESD Ratings

			VALUE	UNIT
$V_{(ESD)}$	Electrostatic discharge	Human-body model (HBM), per ANSI/ESDA/JEDEC JS-001 <sup>(1)</sup>	±2000	V
		Charged-device model (CDM), per JEDEC specification JESD22-C101 <sup>(2)</sup>	±500	

- (1) JEDEC document JEP155 states that 500-V HBM allows safe manufacturing with a standard ESD control process. Manufacturing with less than 500-V HBM is possible with the necessary precautions.
- (2) JEDEC document JEP157 states that 250-V CDM allows safe manufacturing with a standard ESD control process. Manufacturing with less than 250-V CDM is possible with the necessary precautions.

### 6.3 Recommended Operating Conditions

over operating free-air temperature range (unless otherwise noted)

		MIN	NOM	MAX	UNIT
$V_{IN}$	Input voltage	1.5		6.0	V
$V_{OUT}$	Output voltage	0.55		5.5	V
$I_{OUT}$	Output current	0		500	mA
$C_{IN}$	Input capacitor	1			µF
$C_{OUT}$	Output capacitor <sup>(1)</sup>	1		220	µF
$V_{EN}$	Enable voltage <sup>(2)</sup>	0		6.0	V
$f_{EN}$	Enable toggle frequency			10	kHz
$T_J$	Junction temperature	-40		125	°C

- (1) Minimum derated capacitance of 0.47 µF is required for stability
- (2) If  $V_{EN} > V_{IN}$ , when  $V_{EN} > V_{UVLO}$  rising (min), the input pin (IN) must sink 1 mA of current to avoid the device being turned on with floating input pin.

## 6.4 Thermal Information

THERMAL METRIC <sup>(1)</sup>		TLV751P	UNIT
		DSQ (WSON)	
		10 PINS	
R <sub>θJA</sub>	Junction-to-ambient thermal resistance	74.6	°C/W
R <sub>θJC(top)</sub>	Junction-to-case (top) thermal resistance	90.5	°C/W
R <sub>θJB</sub>	Junction-to-board thermal resistance	39.7	°C/W
ψ <sub>JT</sub>	Junction-to-top characterization parameter	3.8	°C/W
ψ <sub>JB</sub>	Junction-to-board characterization parameter	39.7	°C/W
R <sub>θJC(bot)</sub>	Junction-to-case (bottom) thermal resistance	17	°C/W

(1) For more information about traditional and new thermal metrics, see the [Semiconductor and IC Package Thermal Metrics](#) application report.

## 6.5 Electrical Characteristics

At operating temperature range ( $T_J = -40^\circ\text{C}$  to  $+125^\circ\text{C}$ ),  $V_{IN} = V_{OUT(NOM)} + 0.5\text{ V}$  or  $1.5\text{ V}$  (whichever is greater),  $I_{OUT} = 1\text{ mA}$ ,  $V_{EN} = V_{IN}$ , and  $C_{IN} = C_{OUT} = 1\text{ }\mu\text{F}$  (unless otherwise noted); all typical values are at  $T_J = 25^\circ\text{C}$

PARAMETER		TEST CONDITIONS		MIN	TYP	MAX	UNIT	
V <sub>FB</sub>	Feedback voltage	T <sub>J</sub> = 25°C		0.55			V	
	Output accuracy <sup>(1)</sup>	T <sub>J</sub> = 25°C		-0.5%	0.5%			
		-40°C ≤ T <sub>J</sub> ≤ +125°C; V <sub>OUT(NOM)</sub> + 0.5 V <sup>(2)</sup> ≤ V <sub>IN</sub> ≤ 6.0 V		-1.5%	1.5%			
	Line regulation	V <sub>OUT(NOM)</sub> + 0.5 V <sup>(2)</sup> ≤ V <sub>IN</sub> ≤ 6.0 V		2			mV	
	Load regulation	0.1 mA ≤ I <sub>OUT</sub> ≤ 500 mA, V <sub>IN</sub> = V <sub>OUT</sub> + 0.5 V <sup>(3)</sup>		0.030			V/A	
I <sub>GND</sub>	Ground current	I <sub>OUT</sub> = 0 mA	T <sub>J</sub> = 25°C	10	25	31	μA	
			-40°C ≤ T <sub>J</sub> ≤ +125°C					35
I <sub>SHDN</sub>	Shutdown current	V <sub>EN</sub> ≤ 0.3 V, 1.5 V ≤ V <sub>IN</sub> ≤ 6.0 V		0.1			1	μA
I <sub>FB</sub>	Feedback pin current			0.01			0.1	μA
I <sub>CL</sub>	Output current limit	V <sub>IN</sub> = 2 V with V <sub>OUT</sub> < 1 V; otherwise V <sub>IN</sub> = V <sub>OUT(NOM)</sub> + 1.0 V	V <sub>OUT</sub> = V <sub>OUT(NOM)</sub> - 0.2 V, V <sub>OUT</sub> < 1.5 V	530	720	865	mA	
			V <sub>OUT</sub> = 0.9 V × V <sub>OUT(NOM)</sub> , V <sub>OUT</sub> ≥ 1.5 V	530	720	865		
I <sub>SC</sub>	Short-circuit current limit	V <sub>IN</sub> = 2 V with V <sub>OUT</sub> < 1 V; otherwise V <sub>IN</sub> = V <sub>OUT(NOM)</sub> + 1.0 V	V <sub>OUT</sub> = 0 V	310			400	mA
V <sub>DO</sub>	Dropout voltage	I <sub>OUT</sub> = 500 mA, -40°C ≤ T <sub>J</sub> ≤ +125°C, V <sub>OUT</sub> = 0.95 × V <sub>OUT(NOM)</sub>	0.65 V ≤ V <sub>OUT</sub> < 0.8 V	720			880	mV
			0.8 V ≤ V <sub>OUT</sub> < 1.0 V	585			750	
			1.0 V ≤ V <sub>OUT</sub> < 1.2 V	420			570	
			1.2 V ≤ V <sub>OUT</sub> < 1.5 V	285			400	
			1.5 V ≤ V <sub>OUT</sub> < 1.8 V	180			240	
			1.8 V ≤ V <sub>OUT</sub> < 2.5 V	140			190	
			2.5 V ≤ V <sub>OUT</sub> < 3.3 V	102			140	
			3.3 V ≤ V <sub>OUT</sub> ≤ 5.5 V	95			130	
PSRR	Power-supply rejection ratio	V <sub>IN</sub> = V <sub>OUT(NOM)</sub> + 1.0 V, I <sub>OUT</sub> = 50 mA	f = 1 kHz	50			dB	
			f = 100 kHz	45				
			f = 1 MHz	30				
V <sub>n</sub>	Output noise voltage	BW = 10 Hz to 100 kHz, V <sub>OUT</sub> = 0.9 V		53			μV <sub>RMS</sub>	
V <sub>UVLO</sub>	Undervoltage lockout	V <sub>IN</sub> rising	1.21	1.33	1.47	V		
		V <sub>IN</sub> falling	1.17	1.29	1.42	V		
V <sub>UVLO, HYST</sub>	Undervoltage lockout hysteresis	V <sub>IN</sub> hysteresis	45			mV		
t <sub>STR</sub>	Startup time	From EN low-to-high transition to V <sub>OUT</sub> = V <sub>OUT(NOM)</sub> × 95%		500	700	μs		
V <sub>EN(HI)</sub>	EN pin high voltage			1.0			V	
V <sub>EN(LO)</sub>	EN pin low voltage			0.3			V	
I <sub>EN</sub>	Enable pin current	V <sub>IN</sub> = EN = 6.0 V		10			nA	

(1) When the device is connected to external feedback resistors at the FB pin, external resistor tolerances are not included.

(2) V<sub>IN</sub> = 1.5 V for V<sub>OUT</sub> < 1.0 V.

(3) V<sub>IN</sub> = 2.0 V for V<sub>OUT</sub> < 1.5 V.

### Electrical Characteristics (continued)

At operating temperature range ( $T_J = -40^{\circ}\text{C}$  to  $+125^{\circ}\text{C}$ ),  $V_{IN} = V_{OUT(NOM)} + 0.5\text{ V}$  or  $1.5\text{ V}$  (whichever is greater),  $I_{OUT} = 1\text{ mA}$ ,  $V_{EN} = V_{IN}$ , and  $C_{IN} = C_{OUT} = 1\text{ }\mu\text{F}$  (unless otherwise noted); all typical values are at  $T_J = 25^{\circ}\text{C}$

PARAMETER		TEST CONDITIONS	MIN	TYP	MAX	UNIT
$R_{PULL\ DOWN}$	Pulldown resistance	$V_{IN} = 6.0\text{ V}$		95		$\Omega$
$T_{SD}$	Thermal shutdown	Shutdown, temperature increasing		170		$^{\circ}\text{C}$
		Reset, temperature decreasing		155		

### 6.6 Typical Characteristics

at operating temperature range  $T_J = 25^\circ\text{C}$ ,  $V_{IN} = V_{OUT(NOM)} + 0.5\text{ V}$  or  $1.5\text{ V}$  (whichever is greater),  $I_{OUT} = 1\text{ mA}$ ,  $V_{EN} = V_{IN}$ , and  $C_{IN} = C_{OUT} = 1\text{ }\mu\text{F}$  (unless otherwise noted)



图 1. 3.3-V Line Regulation vs  $V_{IN}$



图 2. 0.55-V Line Regulation vs  $V_{IN}$

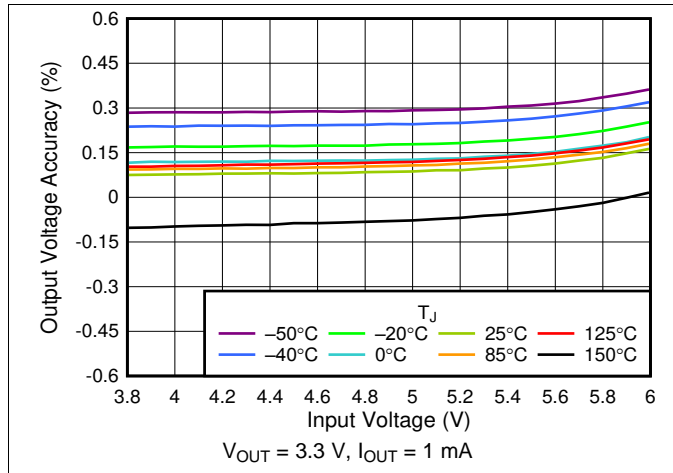

图 3. 5.5-V Line Regulation vs  $V_{IN}$

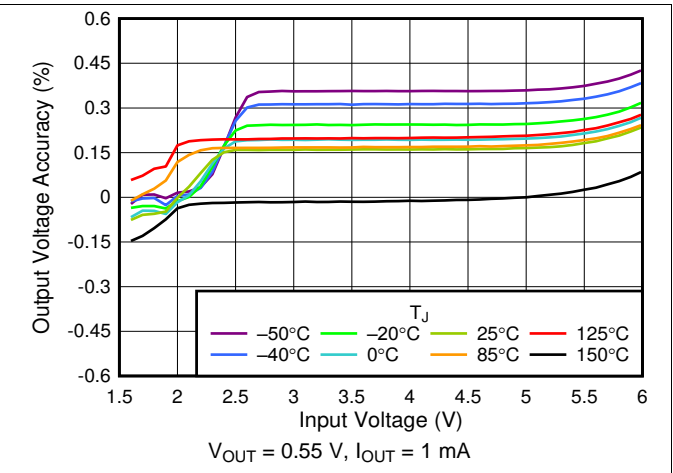

图 4. 3.3-V Dropout Voltage vs  $I_{OUT}$

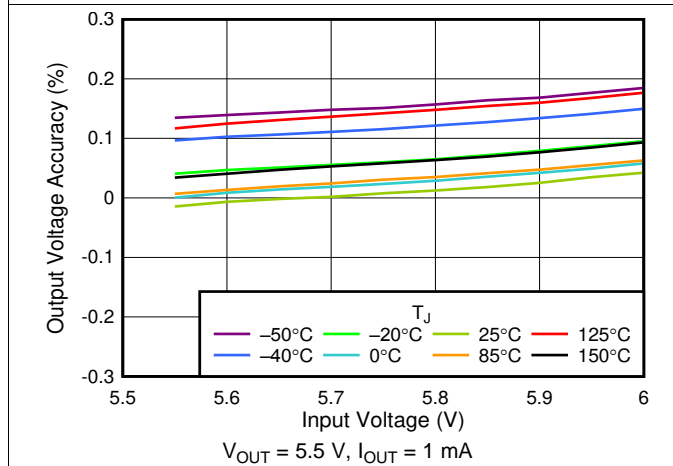

图 5. 0.55-V Dropout Voltage vs  $I_{OUT}$

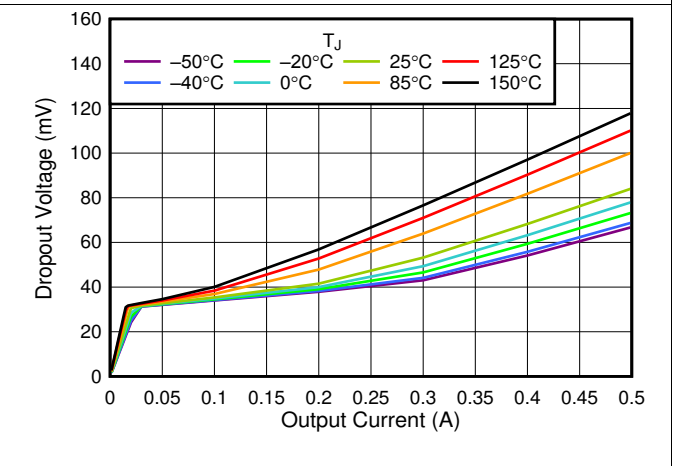

图 6. 5.5-V Dropout Voltage vs  $I_{OUT}$

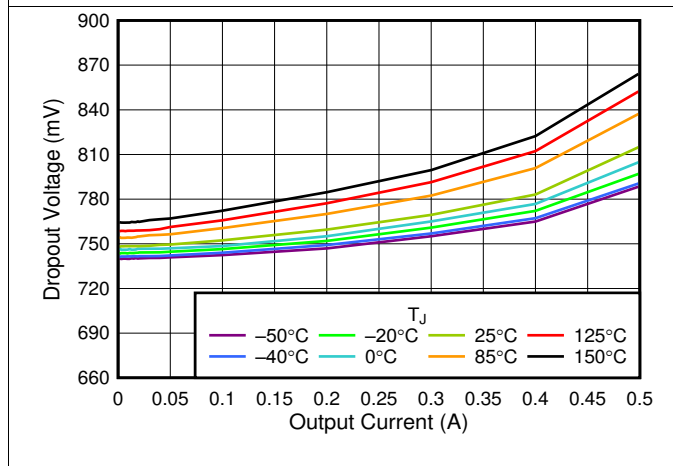

Typical Characteristics (接下页)

at operating temperature range  $T_J = 25^\circ\text{C}$ ,  $V_{IN} = V_{OUT(NOM)} + 0.5\text{ V}$  or  $1.5\text{ V}$  (whichever is greater),  $I_{OUT} = 1\text{ mA}$ ,  $V_{EN} = V_{IN}$ , and  $C_{IN} = C_{OUT} = 1\text{ }\mu\text{F}$  (unless otherwise noted)

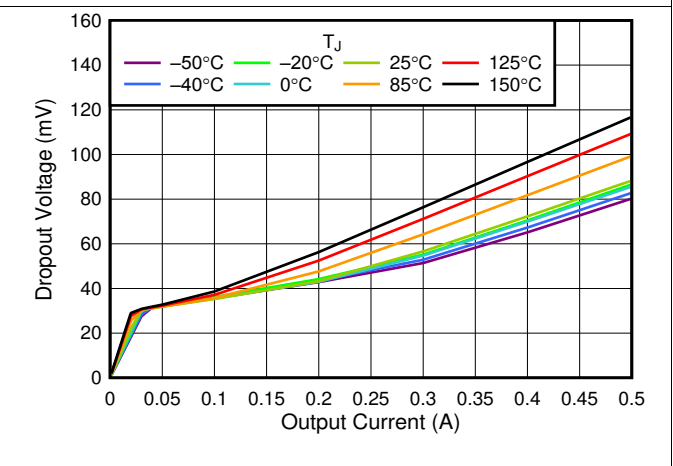

图 7.  $V_{DO}$  vs  $V_{OUT}$



图 8.  $I_{GND}$  vs  $I_{OUT}$

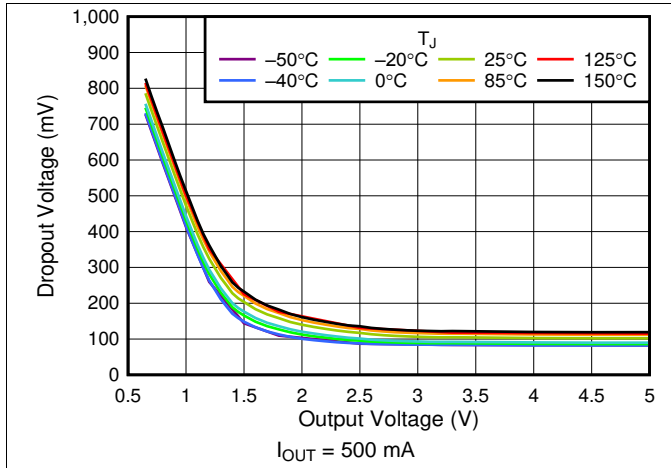

图 9.  $I_{SHDN}$  vs  $V_{IN}$

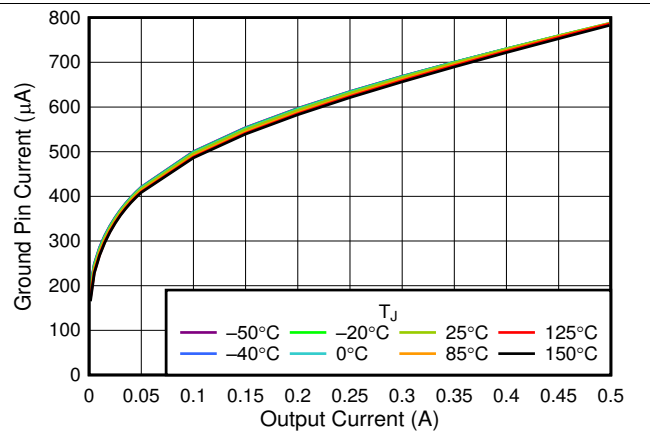

图 10.  $I_{GND}$  vs  $V_{IN}$

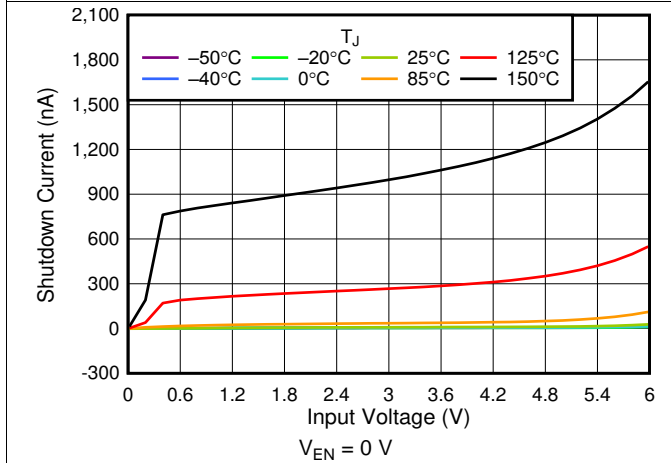

图 11. 3.3-V Load Regulation vs  $I_{OUT}$

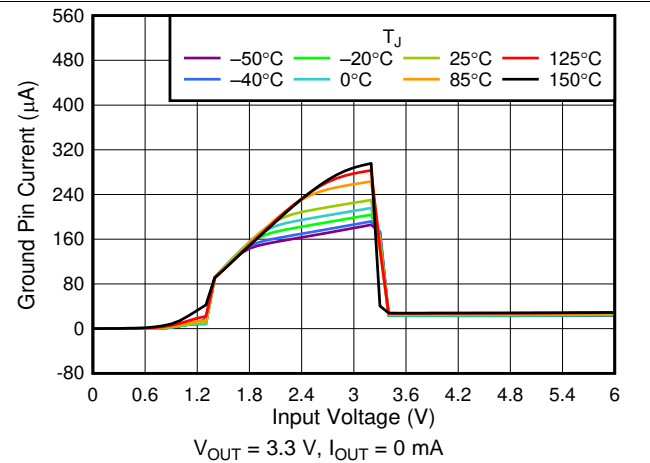

图 12. 0.55-V Load Regulation vs  $I_{OUT}$

Typical Characteristics (接下页)

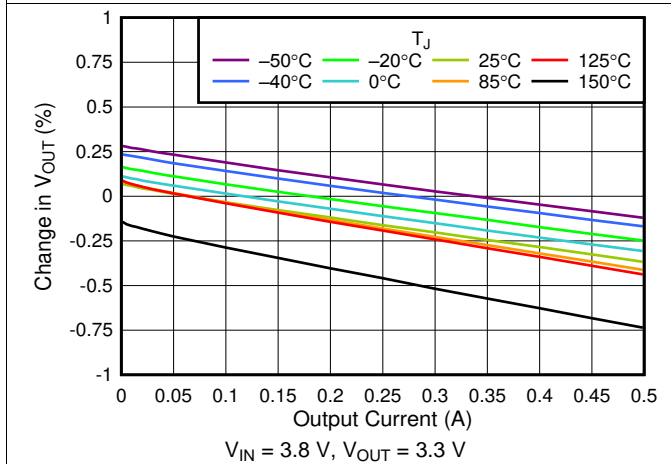
at operating temperature range  $T_J = 25^\circ\text{C}$ ,  $V_{IN} = V_{OUT(NOM)} + 0.5\text{ V}$  or  $1.5\text{ V}$  (whichever is greater),  $I_{OUT} = 1\text{ mA}$ ,  $V_{EN} = V_{IN}$ , and  $C_{IN} = C_{OUT} = 1\text{ }\mu\text{F}$  (unless otherwise noted)

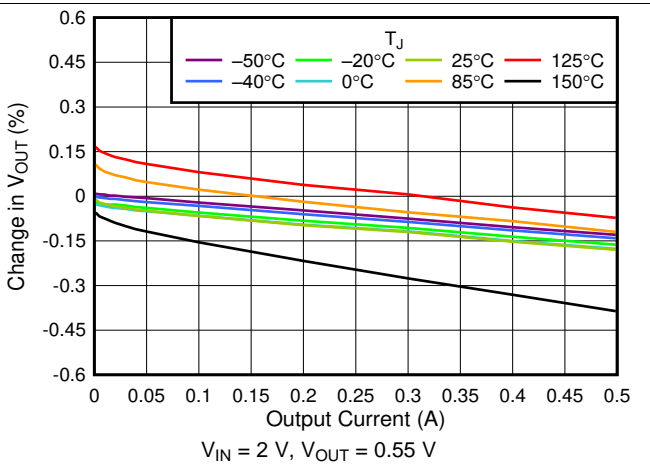

图 13. 5-V Load Regulation vs  $I_{OUT}$



图 14.  $V_{OUT}$  vs  $I_{OUT}$  Pulldown Resistor

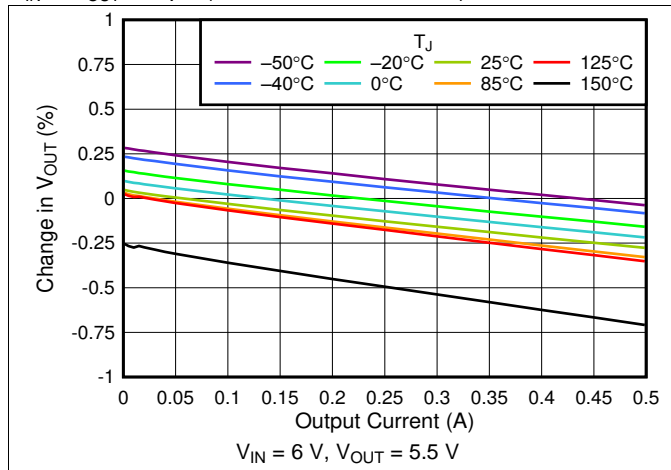

图 15.  $V_{EN(HI)}$  and  $V_{EN(LO)}$  vs Temperature

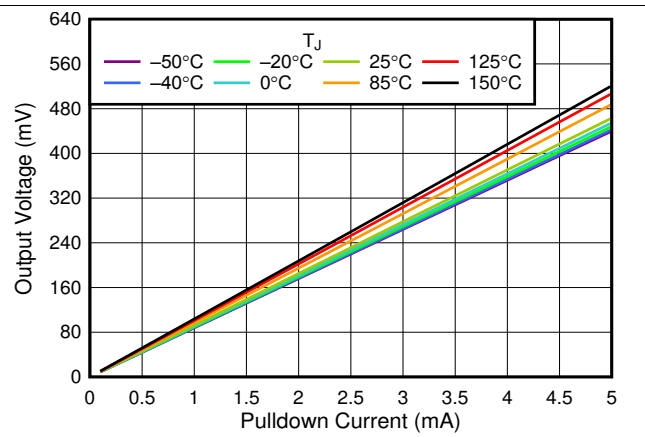

图 16.  $I_{EN}$  vs  $V_{IN}$

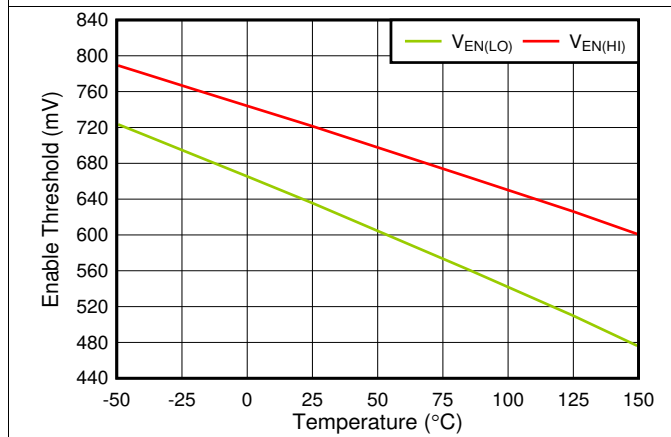

图 17. 3.3-V Foldback Current Limit vs  $I_{OUT}$

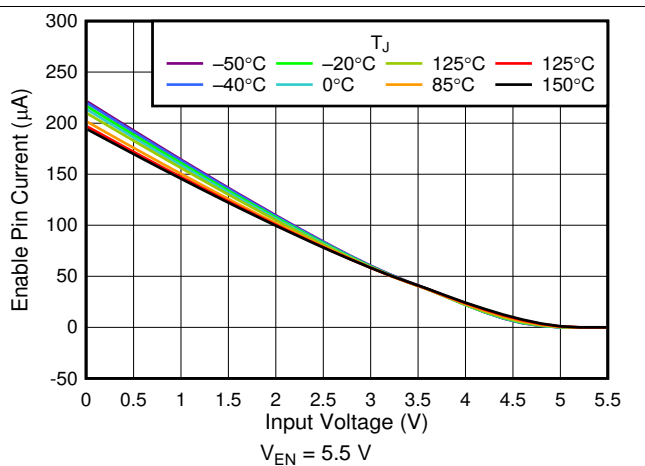

图 18. 0.55-V Line Transient

Typical Characteristics (接下页)

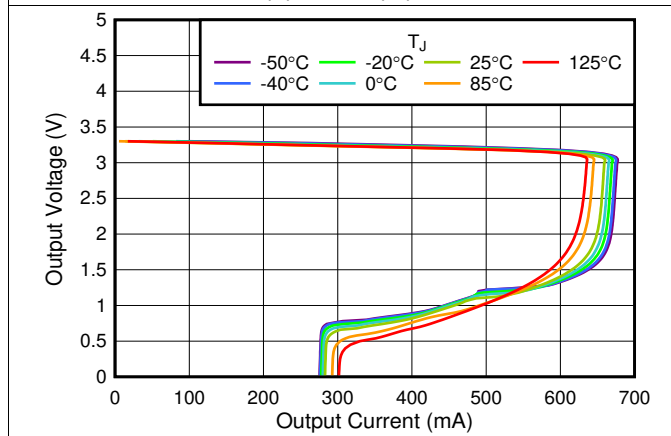
at operating temperature range  $T_J = 25^\circ\text{C}$ ,  $V_{IN} = V_{OUT(NOM)} + 0.5\text{ V}$  or  $1.5\text{ V}$  (whichever is greater),  $I_{OUT} = 1\text{ mA}$ ,  $V_{EN} = V_{IN}$ , and  $C_{IN} = C_{OUT} = 1\text{ }\mu\text{F}$  (unless otherwise noted)

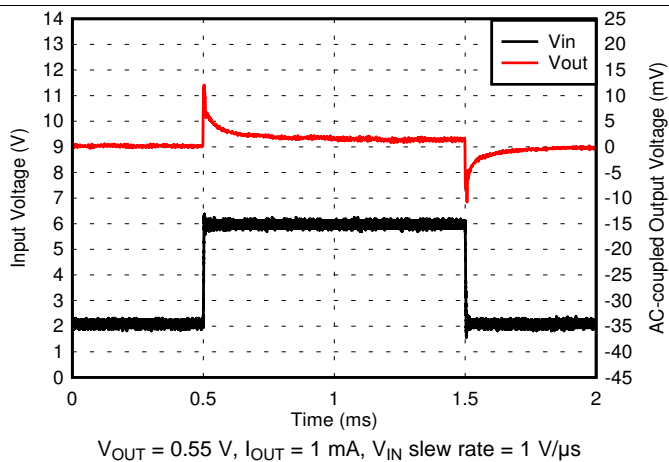

图 19. 3.3-V Line Transient



图 20. 3.3-V, 1-mA to 500-mA Load Transient

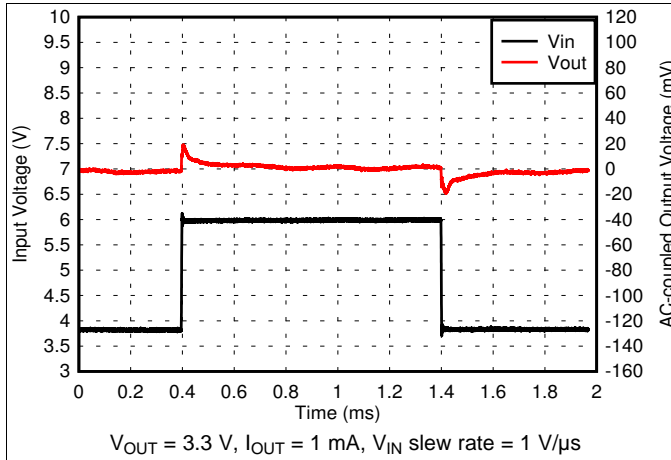

图 21. 0.55-V, 1-mA to 500-mA Load Transient

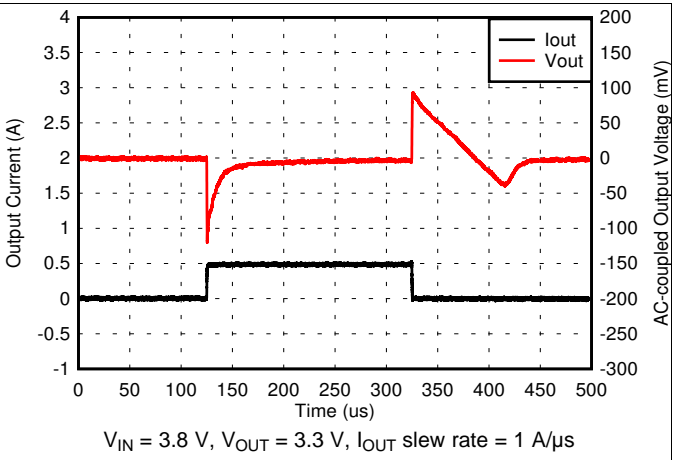

图 22. 5-V, 1-mA to 500-mA Load Transient

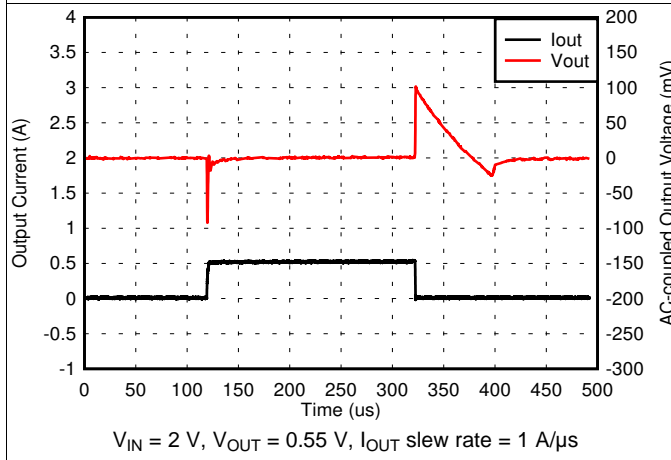

图 23. VIN Power-Up

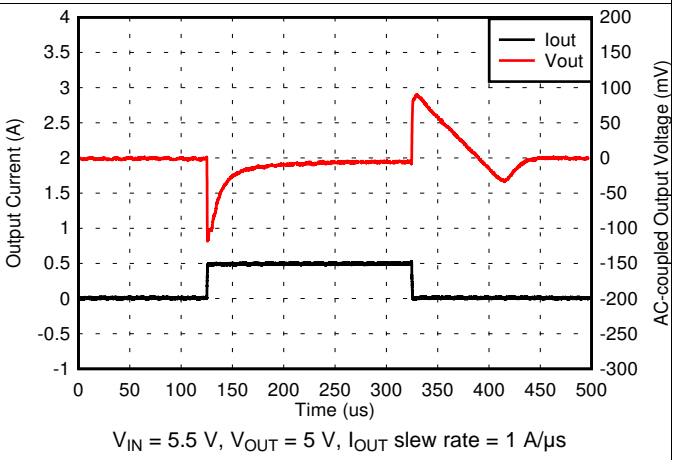

图 24. Startup With EN

Typical Characteristics (接下页)

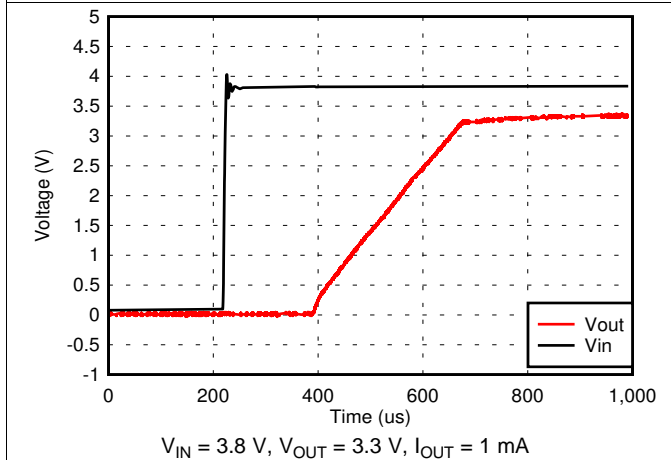
at operating temperature range  $T_J = 25^\circ\text{C}$ ,  $V_{IN} = V_{OUT(NOM)} + 0.5\text{ V}$  or  $1.5\text{ V}$  (whichever is greater),  $I_{OUT} = 1\text{ mA}$ ,  $V_{EN} = V_{IN}$ , and  $C_{IN} = C_{OUT} = 1\text{ }\mu\text{F}$  (unless otherwise noted)

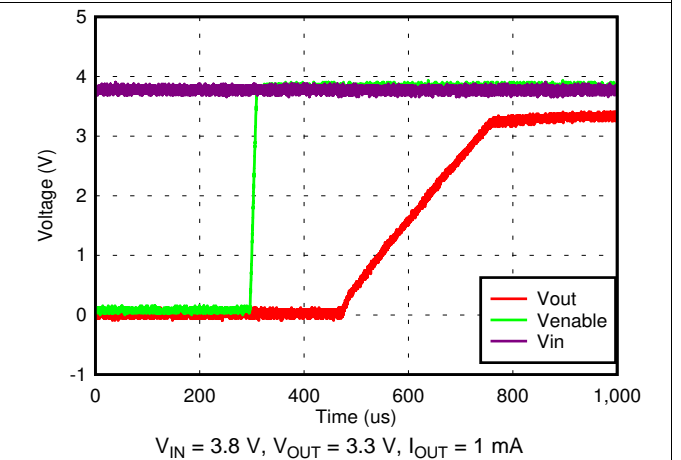
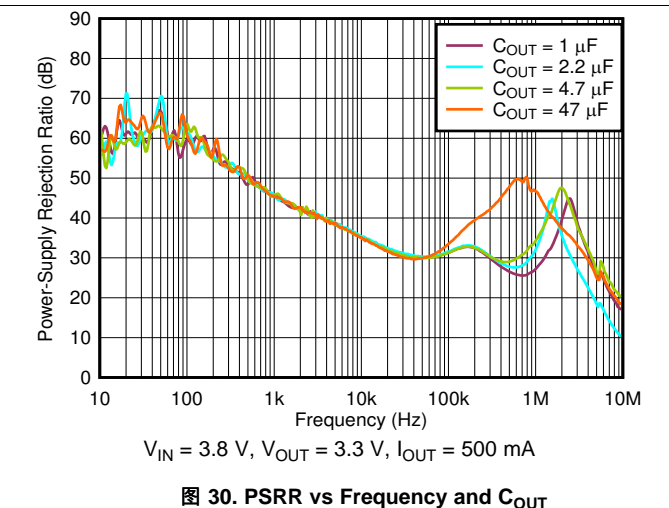
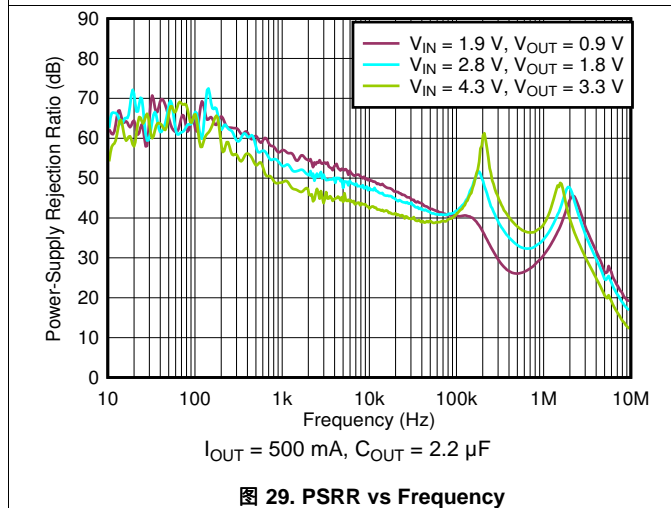
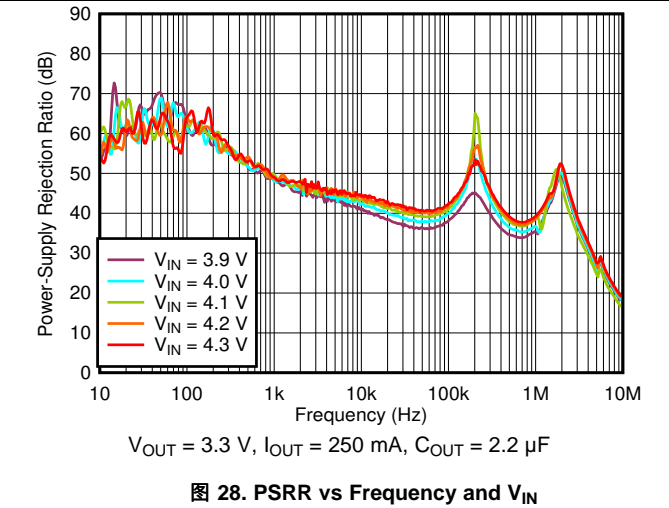
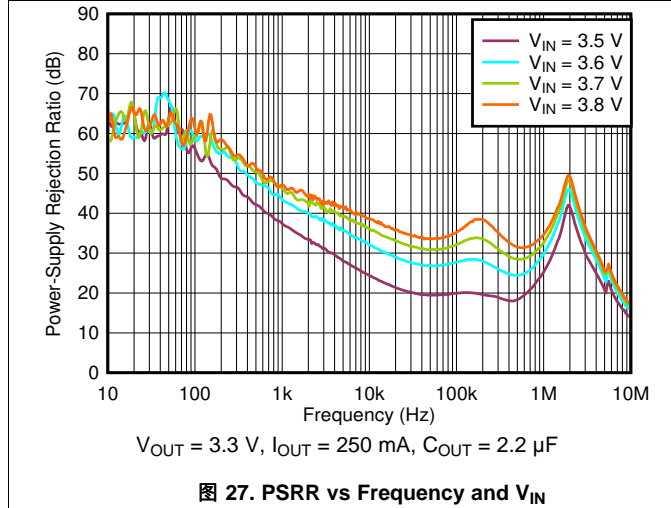
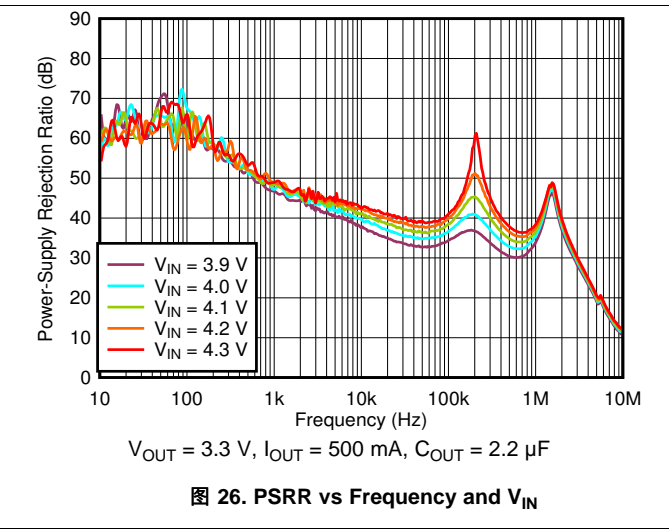
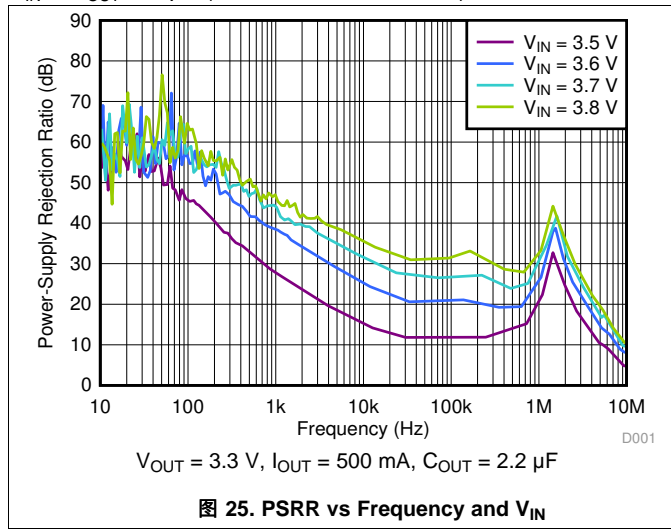

Typical Characteristics (接下页)

at operating temperature range  $T_J = 25^\circ\text{C}$ ,  $V_{IN} = V_{OUT(NOM)} + 0.5\text{ V}$  or  $1.5\text{ V}$  (whichever is greater),  $I_{OUT} = 1\text{ mA}$ ,  $V_{EN} = V_{IN}$ , and  $C_{IN} = C_{OUT} = 1\text{ }\mu\text{F}$  (unless otherwise noted)

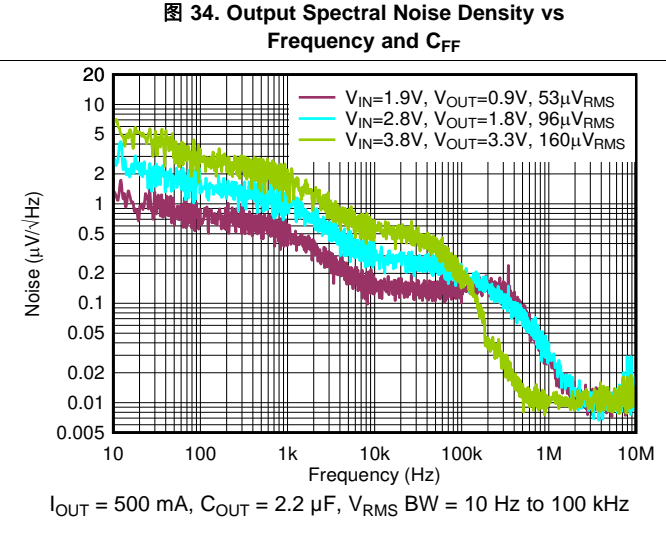
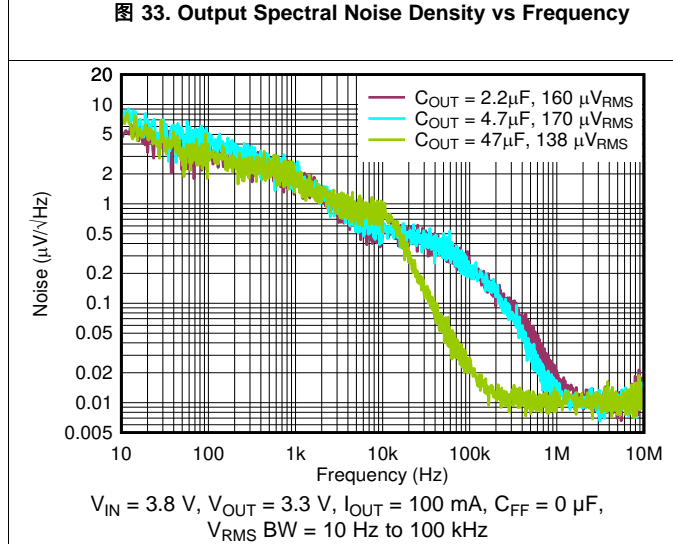
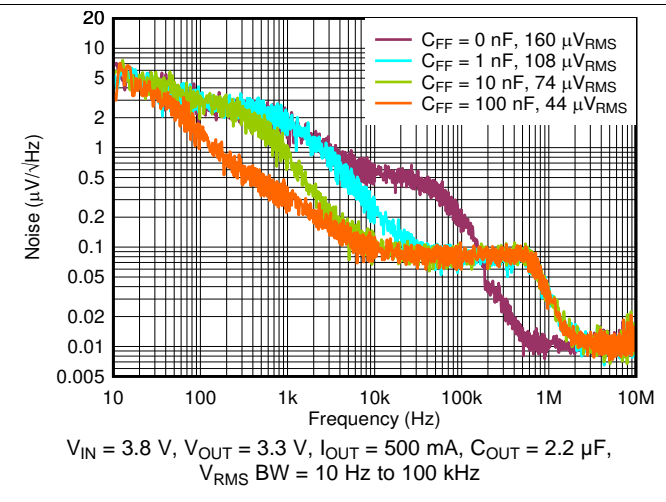
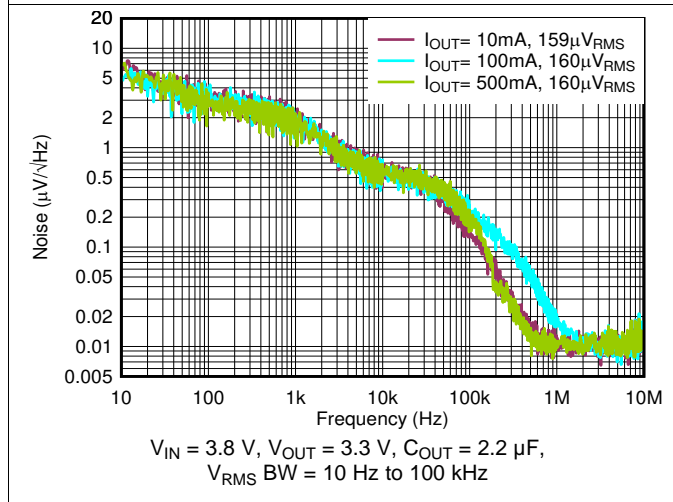
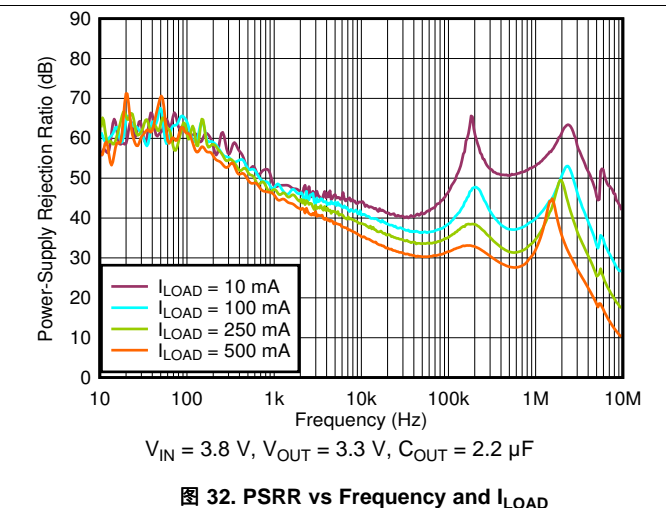
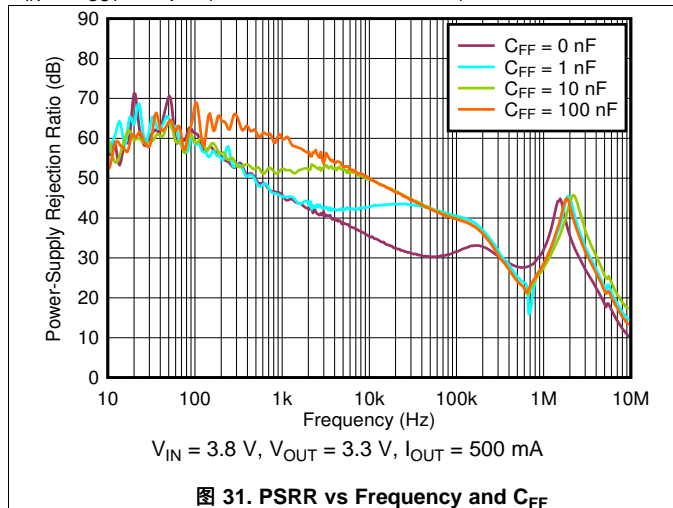

## 7 Detailed Description

### 7.1 Overview

The TLV751 low-dropout regulator (LDO) consumes low quiescent current and delivers excellent line and load transient performance. These characteristics, combined with low noise and good PSRR with low dropout voltage, make this device ideal for portable consumer applications.

This regulator offers foldback current limit, shutdown, and thermal protection. The operating junction temperature for this device is  $-40^{\circ}\text{C}$  to  $+125^{\circ}\text{C}$ .

### 7.2 Functional Block Diagram

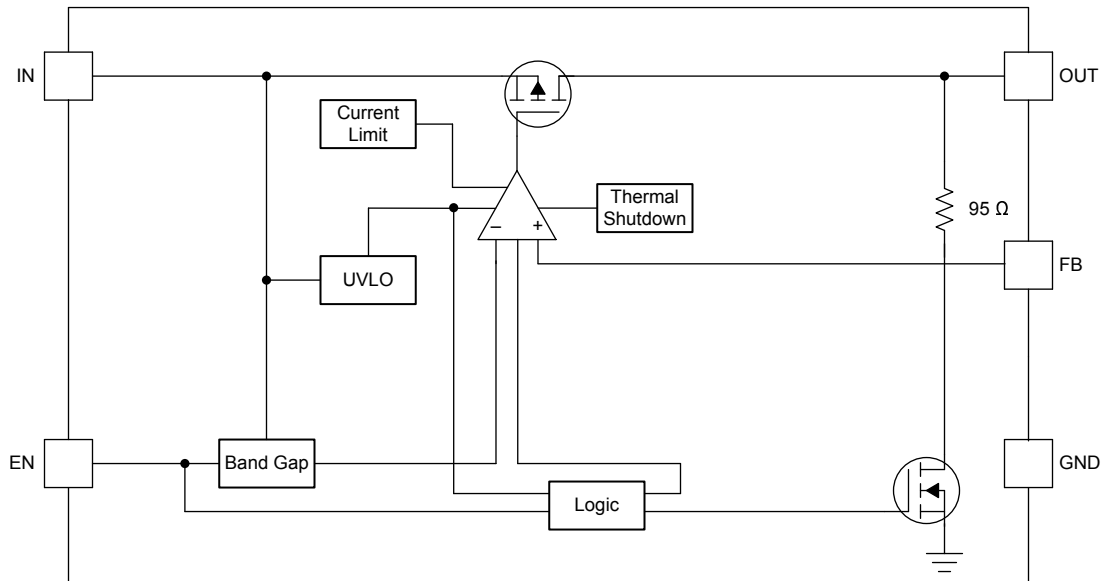

### 7.3 Feature Description

#### 7.3.1 Undervoltage Lockout (UVLO)

The TLV751 uses an undervoltage lockout (UVLO) circuit that disables the output until the input voltage is greater than the rising UVLO voltage ( $V_{UVLO}$ ). This circuit ensures that the device does not exhibit any unpredictable behavior when the supply voltage is lower than the operational range of the internal circuitry. When  $V_{IN}$  is less than  $V_{UVLO}$ , the output is connected to ground with a pulldown resistor ( $R_{PULLDOWN}$ ).

#### 7.3.2 Shutdown

The enable pin (EN) is active high. Enable the device by forcing the EN pin to exceed  $V_{EN(HI)}$ . Turn off the device by forcing the EN pin to drop below  $V_{EN(LO)}$ . If shutdown capability is not required, connect EN to IN.

The TLV751 has an internal pulldown MOSFET that connects an  $R_{PULLDOWN}$  resistor to ground when the device is disabled. The discharge time after disabling depends on the output capacitance ( $C_{OUT}$ ) and the load resistance ( $R_L$ ) in parallel with the pulldown resistor ( $R_{PULLDOWN}$ ). 公式 1 calculates the time constant:

$$\tau = (R_{PULLDOWN} \times R_L) / (R_{PULLDOWN} + R_L) \quad (1)$$

#### 7.3.3 Foldback Current Limit

The device has an internal current limit circuit that protects the regulator during transient high-load current faults or shorting events. The current limit is a hybrid brickwall-foldback scheme. The current limit transitions from a brickwall scheme to a foldback scheme at the foldback voltage ( $V_{FOLDBACK}$ ). In a high-load current fault with the output voltage above  $V_{FOLDBACK}$ , the brickwall scheme limits the output current to the current limit ( $I_{CL}$ ). When the voltage drops below  $V_{FOLDBACK}$ , a foldback current limit activates that scales back the current as the output voltage approaches GND. When the output is shorted, the device supplies a typical current called the short-circuit current limit ( $I_{SC}$ ).  $I_{CL}$  and  $I_{SC}$  are listed in the *Electrical Characteristics* table.

## Feature Description (continued)

For this device,  $V_{\text{FOLDBACK}} = 0.4 \text{ V} \times V_{\text{OUT(NOM)}}$ .

The output voltage is not regulated when the device is in current limit. When a current limit event occurs, the device begins to heat up because of the increase in power dissipation. When the device is in brickwall current limit, the pass transistor dissipates power  $[(V_{\text{IN}} - V_{\text{OUT}}) \times I_{\text{CL}}]$ . When the device output is shorted and the output is below  $V_{\text{FOLDBACK}}$ , the pass transistor dissipates power  $[(V_{\text{IN}} - V_{\text{OUT}}) \times I_{\text{SC}}]$ . If thermal shutdown is triggered, the device turns off. After the device cools down, the internal thermal shutdown circuit turns the device back on. If the output current fault condition continues, the device cycles between current limit and thermal shutdown. For more information on current limits, see the [Know Your Limits application report](#).

Figure 37 shows a diagram of the foldback current limit.

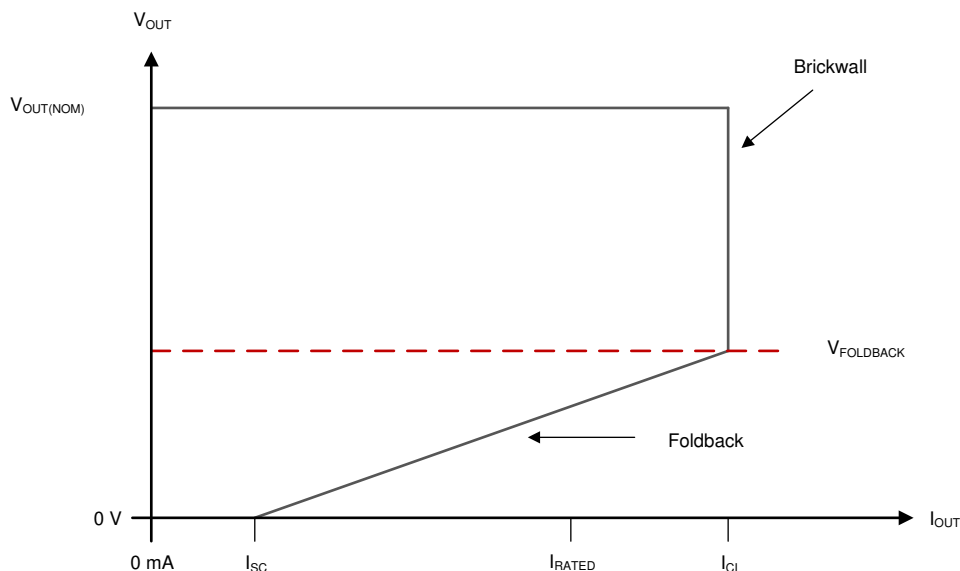

Figure 37. Foldback Current Limit

### 7.3.4 Thermal Shutdown

Thermal shutdown protection disables the output when the junction temperature rises to approximately  $170^{\circ}\text{C}$ . Disabling the device eliminates the power dissipated by the device, allowing the device to cool. When the junction temperature cools to approximately  $155^{\circ}\text{C}$ , the output circuitry is again enabled. Depending on power dissipation, thermal resistance, and ambient temperature, the thermal protection circuit may cycle on and off. This cycling limits regulator dissipation, protecting the LDO from damage as a result of overheating.

Activating the thermal shutdown feature usually indicates excessive power dissipation as a result of the product of the  $(V_{\text{IN}} - V_{\text{OUT}})$  voltage and the load current. For reliable operation, limit junction temperature to  $125^{\circ}\text{C}$  maximum. To estimate the margin of safety in a complete design, increase the ambient temperature until the thermal protection is triggered; use worst-case loads and signal conditions.

The TLV751 internal protection circuitry protects against overload conditions but is not intended to be activated in normal operation. Continuously running the TLV751 into thermal shutdown degrades device reliability.

## 7.4 Device Functional Modes

### 7.4.1 Device Functional Mode Comparison

The *Device Functional Mode Comparison* table shows the conditions that lead to the different modes of operation. See the *Electrical Characteristics* table for parameter values.

**Table 1. Device Functional Mode Comparison**

OPERATING MODE	PARAMETER			
	$V_{IN}$	$V_{EN}$	$I_{OUT}$	$T_J$
Normal operation	$V_{IN} > V_{OUT(nom)} + V_{DO}$ and $V_{IN} > V_{IN(min)}$	$V_{EN} > V_{EN(HI)}$	$I_{OUT} < I_{OUT(max)}$	$T_J < T_{SD(shutdown)}$
Dropout operation	$V_{IN(min)} < V_{IN} < V_{OUT(nom)} + V_{DO}$	$V_{EN} > V_{EN(HI)}$	$I_{OUT} < I_{OUT(max)}$	$T_J < T_{SD(shutdown)}$
Disabled (any true condition disables the device)	$V_{IN} < V_{UVLO}$	$V_{EN} < V_{EN(LOW)}$	Not applicable	$T_J > T_{SD(shutdown)}$

### 7.4.2 Normal Operation

The device regulates to the nominal output voltage when the following conditions are met:

- The input voltage is greater than the nominal output voltage plus the dropout voltage ( $V_{OUT(nom)} + V_{DO}$ )
- The output current is less than the current limit ( $I_{OUT} < I_{CL}$ )
- The device junction temperature is less than the thermal shutdown temperature ( $T_J < T_{SD}$ )
- The enable voltage has previously exceeded the enable rising threshold voltage and has not yet decreased to less than the enable falling threshold

### 7.4.3 Dropout Operation

If the input voltage is lower than the nominal output voltage plus the specified dropout voltage, but all other conditions are met for normal operation, the device operates in dropout mode. In this mode, the output voltage tracks the input voltage. During this mode, the transient performance of the device becomes significantly degraded because the pass transistor is in the ohmic or triode region, and acts as a switch. Line or load transients in dropout can result in large output-voltage deviations.

When the device is in a steady dropout state (defined as when the device is in dropout,  $V_{IN} < V_{OUT(NOM)} + V_{DO}$ , directly after being in a normal regulation state, but *not* during startup), the pass transistor is driven into the ohmic or triode region. When the input voltage returns to a value greater than or equal to the nominal output voltage plus the dropout voltage ( $V_{OUT(NOM)} + V_{DO}$ ), the output voltage can overshoot for a short period of time while the device pulls the pass transistor back into the linear region.

### 7.4.4 Disabled

The output of the device can be shutdown by forcing the voltage of the enable pin to less than the maximum EN pin low-level input voltage (see the *Electrical Characteristics* table). When disabled, the pass transistor is turned off, internal circuits are shutdown, and the output voltage is actively discharged to ground by an internal discharge circuit from the output to ground.



## 8 Application and Implementation

### 注

Information in the following applications sections is not part of the TI component specification, and TI does not warrant its accuracy or completeness. TI's customers are responsible for determining suitability of components for their purposes. Customers should validate and test their design implementation to confirm system functionality.

### 8.1 Application Information

#### 8.1.1 Adjustable Device Feedback Resistors

图 38 shows that the output voltage of the TLV751 can be adjusted from 0.55 V to 5.5 V by using a resistor divider network.



图 38. Adjustable Operation

The adjustable-version device requires external feedback divider resistors to set the output voltage.  $V_{OUT}$  is set using the feedback divider resistors,  $R_1$  and  $R_2$ , according to the following equation:

$$V_{OUT} = V_{FB} \times (1 + R_1 / R_2) \quad (2)$$

For this device,  $V_{FB} = 0.55$  V.

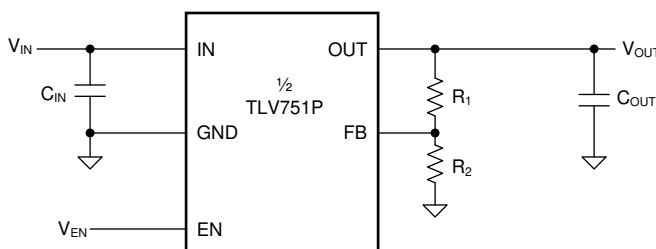
To ignore the FB pin current error term in the  $V_{OUT}$  equation, set the feedback divider current to 100x the FB pin current listed in the *Electrical Characteristics* table. This setting provides the maximum feedback divider series resistance, as shown in the following equation:

$$R_1 + R_2 \leq V_{OUT} / (I_{FB} \times 100) \quad (3)$$

For this device,  $I_{FB} = 10$  nA.

#### 8.1.2 Input and Output Capacitor Selection

The TLV751 requires an output capacitance of 0.47  $\mu$ F or larger for stability. Use X5R- and X7R-type ceramic capacitors because these capacitors have minimal variation in value and equivalent series resistance (ESR) over temperature. When choosing a capacitor for a specific application, pay attention to the dc bias characteristics for the capacitor. Higher output voltages cause a significant derating of the capacitor. For best performance, the maximum recommended output capacitance is 220  $\mu$ F.

Although an input capacitor is not required for stability, good analog design practice is to connect a capacitor from IN to GND. Some input supplies have a high impedance, thus placing the input capacitor on the input supply helps reduce the input impedance. This capacitor counteracts reactive input sources and improves transient response, input ripple, and PSRR. If the input supply has a high impedance over a large range of frequencies, several input capacitors can be used in parallel to lower the impedance over frequency. Use a higher-value capacitor if large, fast, rise-time load transients are anticipated, or if the device is located several inches from the input power source.

## Application Information (接下页)

### 8.1.3 Dropout Voltage

The TLV751 uses a PMOS pass transistor to achieve low dropout. When  $(V_{IN} - V_{OUT})$  is less than the dropout voltage ( $V_{DO}$ ), the PMOS pass device is in the linear region of operation and the input-to-output resistance is the  $R_{DS(ON)}$  of the PMOS pass element.  $V_{DO}$  scales approximately with output current because the PMOS device behaves like a resistor in dropout mode. As with any linear regulator, PSRR and transient response degrade as  $(V_{IN} - V_{OUT})$  approaches dropout operation.

### 8.1.4 Exiting Dropout

Some applications have transients that place the LDO into dropout, such as slower ramps on  $V_{IN}$  during start-up. As with other LDOs, the output may overshoot on recovery from these conditions. A ramping input supply causes an LDO to overshoot on start-up, as shown in 图 39, when the slew rate and voltage levels are in the correct range. Use an enable signal to avoid this condition.



图 39. Startup Into Dropout

Line transients out of dropout can also cause overshoot on the output of the regulator. These overshoots are caused by the error amplifier having to drive the gate capacitance of the pass element and bring the gate back to the correct voltage for proper regulation. 图 40 illustrates what is happening internally with the gate voltage and how overshoot can be caused during operation. When the LDO is placed in dropout, the gate voltage ( $V_{GS}$ ) is pulled all the way down to ground to give the pass device the lowest on-resistance as possible. However, if a line transient occurs when the device is in dropout, the loop is not in regulation and can cause the output to overshoot until the loop responds and the output current pulls the output voltage back down into regulation. If these transients are not acceptable, then continue to add input capacitance in the system until the transient is slow enough to reduce the overshoot.

Application Information (接下页)

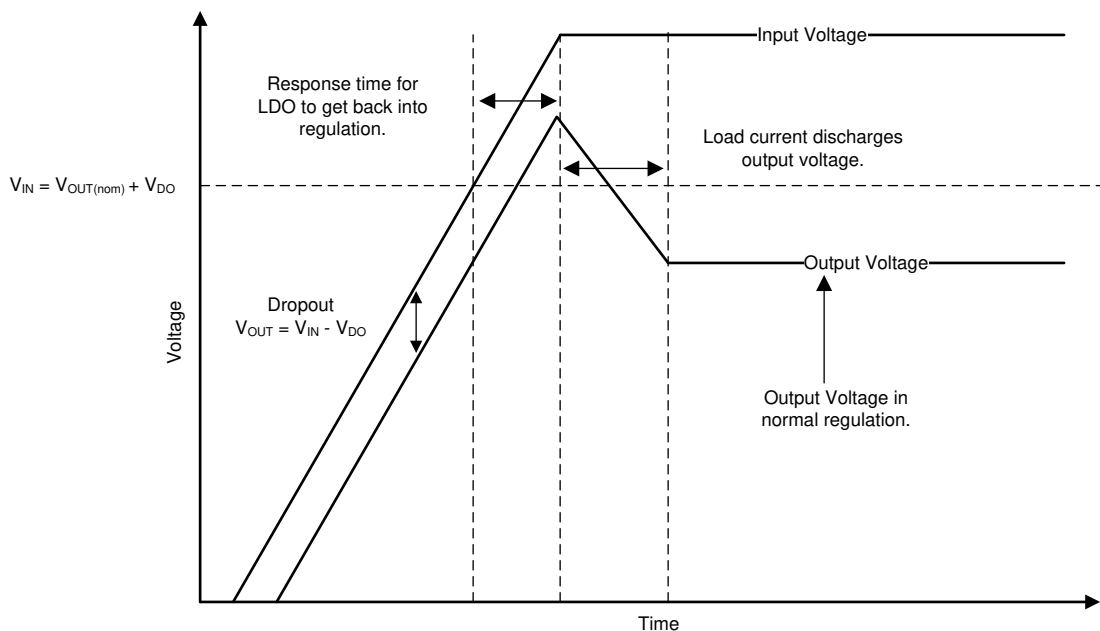

图 40. Line Transients From Dropout

8.1.5 Reverse Current

As with most LDOs, excessive reverse current can damage this device.

Reverse current flows through the body diode on the pass element instead of the normal conducting channel. At high magnitudes, this current flow degrades the long-term reliability of the device, as a result of one of the following conditions:

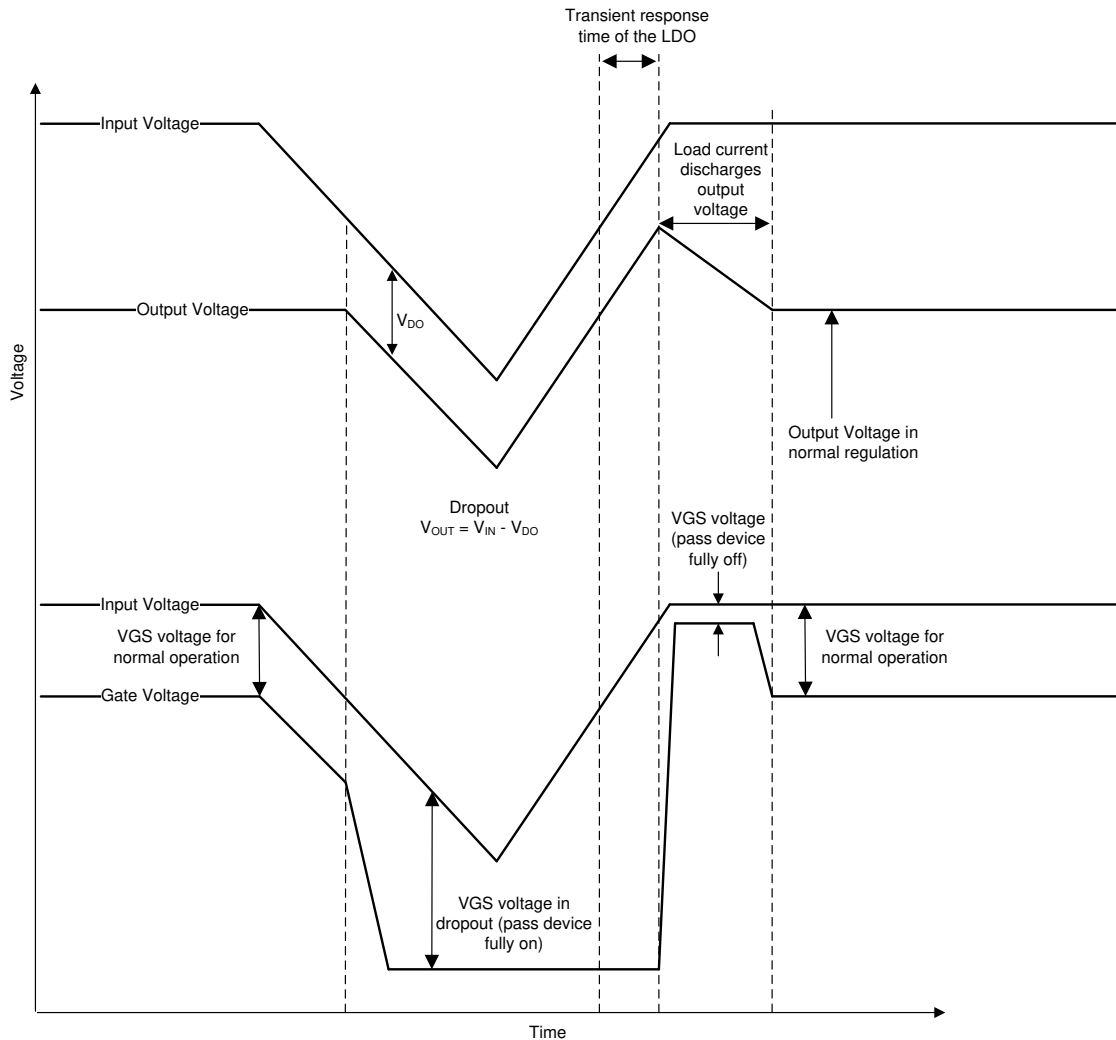
- Degradation caused by electromigration
- Excessive heat dissipation
- Potential for a latch-up condition

Conditions where reverse current can occur are outlined in this section, all of which can exceed the absolute maximum rating of  $V_{OUT} > V_{IN} + 0.3\text{ V}$ :

- If the device has a large  $C_{OUT}$  and the input supply collapses with little or no load current
- The output is biased when the input supply is not established
- The output is biased above the input supply

## Application Information (接下页)

If reverse current flow is expected in the application, external protection must be used to protect the device. [图 41](#) shows one approach of protecting the device.



图 41. Example Circuit for Reverse Current Protection Using a Schottky Diode

### 8.1.6 Power Dissipation ( $P_D$ )

Circuit reliability requires consideration of the device power dissipation, location of the circuit on the printed circuit board (PCB), and correct sizing of the thermal plane. The PCB area around the regulator must have few or no other heat-generating devices that cause added thermal stress.

To first-order approximation, power dissipation in the regulator depends on the input-to-output voltage difference and load conditions. [Equation 4](#) calculates power dissipation ( $P_D$ ).

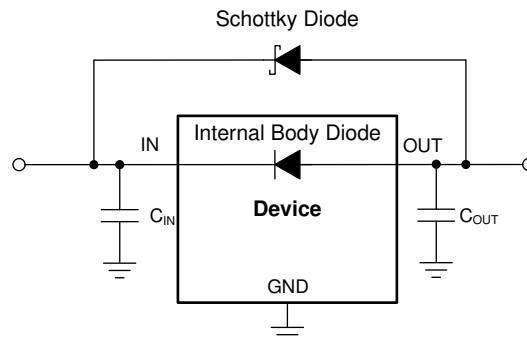
$$P_D = (V_{IN} - V_{OUT}) \times I_{OUT} \tag{4}$$

#### NOTE

Power dissipation can be minimized, and therefore greater efficiency can be achieved, by correct selection of the system voltage rails. For the lowest power dissipation use the minimum input voltage required for correct output regulation.

For devices with a thermal pad, the primary heat conduction path for the device package is through the thermal pad to the PCB. Solder the thermal pad to a copper pad area under the device. This pad area must contain an array of plated vias that conduct heat to additional copper planes for increased heat dissipation.

The maximum power dissipation determines the maximum allowable ambient temperature ( $T_A$ ) for the device. According to [Equation 5](#), power dissipation and junction temperature are most often related by the junction-to-ambient thermal resistance ( $R_{\theta JA}$ ) of the combined PCB and device package and the temperature of the ambient air ( $T_A$ ).

$$T_J = T_A + (R_{\theta JA} \times P_D) \tag{5}$$

Thermal resistance ( $R_{\theta JA}$ ) is highly dependent on the heat-spreading capability built into the particular PCB design, and therefore varies according to the total copper area, copper weight, and location of the planes. The junction-to-ambient thermal resistance listed in the *Thermal Information* table is determined by the JEDEC standard PCB and copper-spreading area, and is used as a relative measure of package thermal performance.

### 8.1.7 Feed-Forward Capacitor ( $C_{FF}$ )

For the adjustable-voltage version device, a feed-forward capacitor ( $C_{FF}$ ) can be connected from the OUT pin to the FB pin.  $C_{FF}$  improves transient, noise, and PSRR performance, but is not required for regulator stability. Recommended  $C_{FF}$  values are listed in the *Recommended Operating Conditions* table. A higher capacitance  $C_{FF}$  can be used; however, the startup time increases. For a detailed description of  $C_{FF}$  tradeoffs, see the [Pros and Cons of Using a Feedforward Capacitor with a Low-Dropout Regulator](#) application report.

## 8.2 Typical Application

图 42 shows the typical application circuit for the TLV751. Input and output capacitances must be at least 1  $\mu\text{F}$ .



图 42. TLV751 Typical Application

### 8.2.1 Design Requirements

Use the parameters listed in 表 2 for typical linear regulator applications.

表 2. Design Parameters

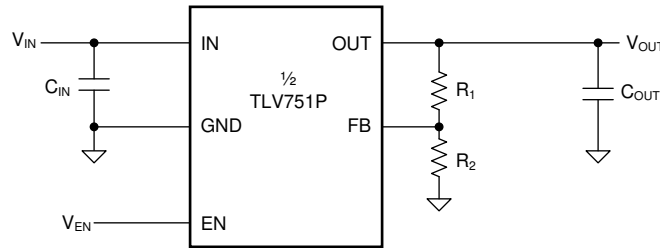
PARAMETER	DESIGN REQUIREMENT
Input voltage	3.8 V
Output voltage	3.3 V, $\pm 1\%$
Input current	500 mA (maximum)
Output load	500-mA dc
Maximum ambient temperature	70°C

### 8.2.2 Detailed Design Procedure

Input and output capacitors are required to achieve the output voltage transient requirements. Capacitance values of 2.2  $\mu\text{F}$  are selected to give the maximum output capacitance in a small, low-cost package; see the [Input and Output Capacitor Selection](#) section for details.

图 38 illustrates the output voltage of the TLV751; set the output voltage using the resistor divider.

#### 8.2.2.1 Input Current

During normal operation, the input current to the LDO is approximately equal to the output current of the LDO. During startup, the input current is higher as a result of the inrush current charging the output capacitor. Use 公式 6 to calculate the current through the input.

$$I_{\text{OUT}(t)} = \left[ \frac{C_{\text{OUT}} \times dV_{\text{OUT}}(t)}{dt} \right] + \left[ \frac{V_{\text{OUT}}(t)}{R_{\text{LOAD}}} \right]$$

where:

- $V_{\text{OUT}}(t)$  is the instantaneous output voltage of the turn-on ramp
- $dV_{\text{OUT}}(t) / dt$  is the slope of the  $V_{\text{OUT}}$  ramp
- $R_{\text{LOAD}}$  is the resistive load impedance

(6)

### 8.2.2.2 Thermal Dissipation

The junction temperature can be determined using the junction-to-ambient thermal resistance ( $R_{\theta JA}$ ) and the total power dissipation ( $P_D$ ). Use 公式 7 to calculate the power dissipation. Multiply  $P_D$  by  $R_{\theta JA}$  as 公式 8 shows and add the ambient temperature ( $T_A$ ) to calculate the junction temperature ( $T_J$ ).

$$P_D = (I_{GND} + I_{OUT}) \times (V_{IN} - V_{OUT}) \tag{7}$$

$$T_J = R_{\theta JA} \times P_D + T_A \tag{8}$$

Calculate the maximum ambient temperature as 公式 9 shows if the ( $T_{J(MAX)}$ ) value does not exceed 125°C. 公式 10 calculates the maximum ambient temperature with a value of 104.93°C.

$$T_{A(MAX)} = T_{J(MAX)} - R_{\theta JA} \times P_D \tag{9}$$

$$T_{A(MAX)} = 125^\circ\text{C} - 80.3^\circ\text{C/W} \times (3.8\text{ V} - 3.3\text{ V}) \times (0.5\text{ A}) = 104.93^\circ\text{C} \tag{10}$$

### 8.2.3 Application Curve

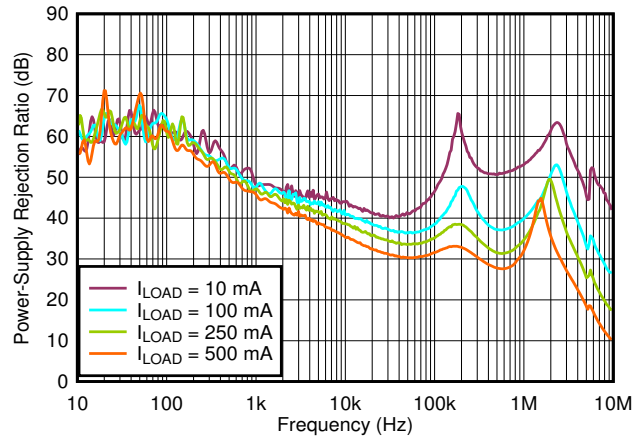

$V_{IN} = 3.8\text{ V}$ ,  $V_{OUT} = 3.3\text{ V}$ ,  $C_{OUT} = 2.2\text{ }\mu\text{F}$

图 43. PSRR vs Frequency and  $I_{LOAD}$

## 9 Power Supply Recommendations

Connect a low output impedance power supply directly to the IN pin of the TLV751.

## 10 Layout

### 10.1 Layout Guidelines

- Place input and output capacitors as close to the device as possible.
- Use copper planes for device connections, in order to optimize thermal performance.
- Place thermal vias around the device to distribute the heat.
- Do not place a thermal via directly beneath the thermal pad of the DSQ package. A via can wick solder or solder paste away from the thermal pad joint during the soldering process, leading to a compromised solder joint on the thermal pad.

### 10.2 Layout Example



图 44. DSQ Package Layout Example

## 11 器件和文档支持

### 11.1 器件支持

#### 11.1.1 器件命名规则

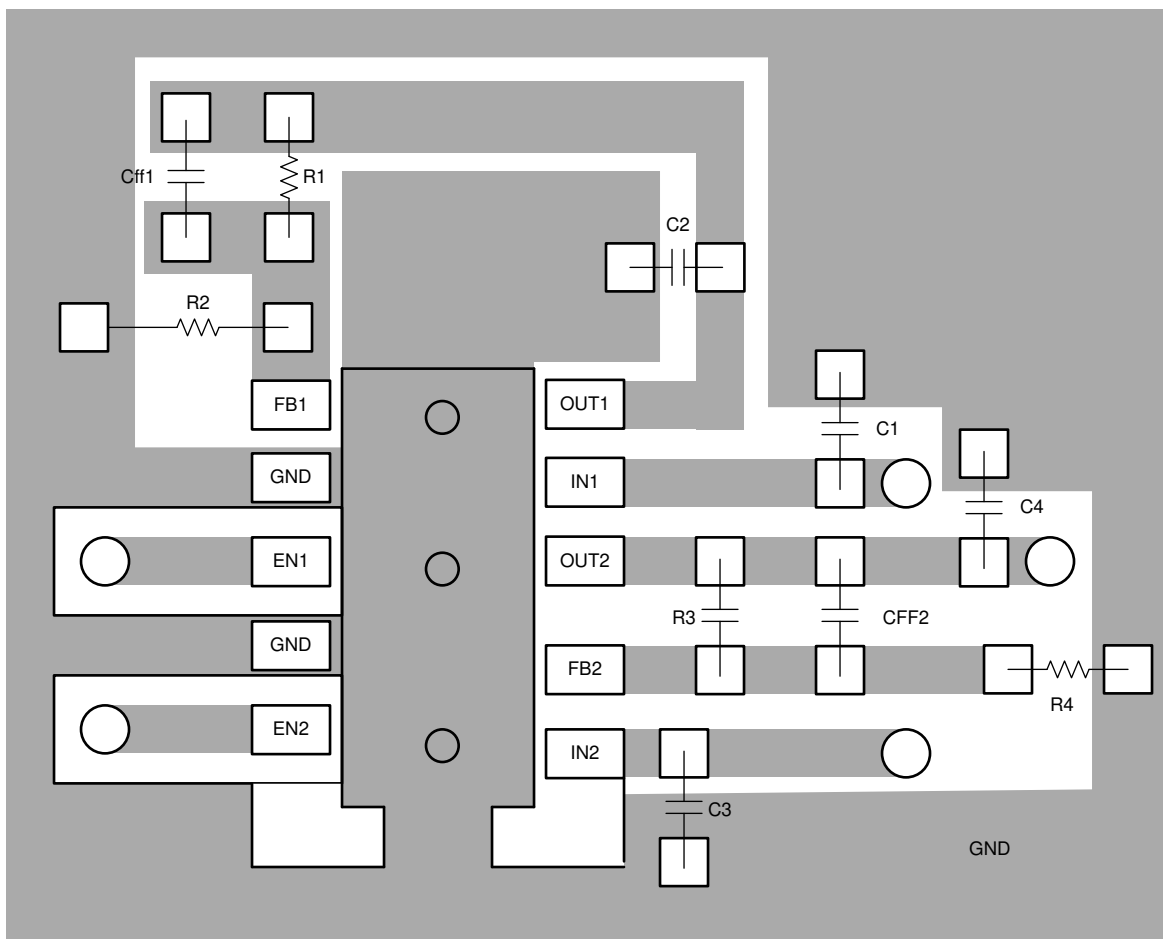
表 3. 器件命名规则<sup>(1)(2)</sup>

产品	V <sub>OUT</sub>
TLV75101Pyyyz	yyy 为封装标识符。 z 为封装数量。R 表示卷（3000 片），T 表示带（250 片）。
TLV751aaabbbPyyyz	aaa 为通道 1 的标称输出电压 bbb 为通道 2 的标称输出电压 yyy 为封装标识符。 z 为封装数量。R 表示卷（3000 片）。

(1) 要获得最新的封装和订货信息，请参阅本文档末尾的封装选项附录，或者访问器件产品文件夹（[www.ti.com.cn](http://www.ti.com.cn)）。

(2) 可提供 0.6V 至 5.0V 范围内的输出电压（以 50mV 为单位增量）。有关器件的详细信息和供货情况，请联系制造商。

### 11.2 接收文档更新通知

要接收文档更新通知，请导航至 [ti.com.cn](http://ti.com.cn) 上的器件产品文件夹。单击右上角的通知我进行注册，即可每周接收产品信息更改摘要。有关更改的详细信息，请查看任何已修订文档中包含的修订历史记录。

### 11.3 社区资源

TI E2E™ support forums are an engineer's go-to source for fast, verified answers and design help — straight from the experts. Search existing answers or ask your own question to get the quick design help you need.

Linked content is provided "AS IS" by the respective contributors. They do not constitute TI specifications and do not necessarily reflect TI's views; see TI's [Terms of Use](#).

### 11.4 商标

E2E is a trademark of Texas Instruments.

All other trademarks are the property of their respective owners.

### 11.5 静电放电警告



ESD 可能会损坏该集成电路。德州仪器 (TI) 建议通过适当的预防措施处理所有集成电路。如果不遵守正确的处理措施和安装程序，可能会损坏集成电路。

ESD 的损坏小至导致微小的性能降级，大至整个器件故障。精密的集成电路可能更容易受到损坏，这是因为非常细微的参数更改都可能会导致器件与其发布的规格不相符。

### 11.6 Glossary

SLYZ022 — TI Glossary.

This glossary lists and explains terms, acronyms, and definitions.

## 12 机械、封装和可订购信息

以下页面包含机械、封装和可订购信息。这些信息是指定器件的最新可用数据。数据如有变更，恕不另行通知，且不会对此文档进行修订。如需获取此数据表的浏览器版本，请查阅左侧的导航栏。



**PACKAGING INFORMATION**

Orderable Device	Status (1)	Package Type	Package Drawing	Pins	Package Qty	Eco Plan (2)	Lead finish/ Ball material (6)	MSL Peak Temp (3)	Op Temp (°C)	Device Marking (4/5)	Samples
TLV75101PDSQR	ACTIVE	WSON	DSQ	10	3000	RoHS & Green	NIPDAU	Level-1-260C-UNLIM	-40 to 125	1XUH	<a href="#">Samples</a>
TLV75101PDSQT	ACTIVE	WSON	DSQ	10	250	RoHS & Green	NIPDAU	Level-1-260C-UNLIM	-40 to 125	1XUH	<a href="#">Samples</a>
TLV751120280PDSQR	ACTIVE	WSON	DSQ	10	3000	RoHS & Green	NIPDAU	Level-2-260C-1 YEAR	-40 to 125	2AOH	<a href="#">Samples</a>
TLV751180280PDSQR	ACTIVE	WSON	DSQ	10	3000	RoHS & Green	NIPDAU	Level-2-260C-1 YEAR	-40 to 125	2ALH	<a href="#">Samples</a>
TLV751180300PDSQR	ACTIVE	WSON	DSQ	10	3000	RoHS & Green	NIPDAU	Level-2-260C-1 YEAR	-40 to 125	2A1H	<a href="#">Samples</a>
TLV751180330PDSQR	ACTIVE	WSON	DSQ	10	3000	RoHS & Green	NIPDAU	Level-2-260C-1 YEAR	-40 to 125	2AMH	<a href="#">Samples</a>
TLV751330500PDSQR	ACTIVE	WSON	DSQ	10	3000	RoHS & Green	NIPDAU	Level-2-260C-1 YEAR	-40 to 125	2ANH	<a href="#">Samples</a>

(1) The marketing status values are defined as follows:

**ACTIVE:** Product device recommended for new designs.

**LIFEBUY:** TI has announced that the device will be discontinued, and a lifetime-buy period is in effect.

**NRND:** Not recommended for new designs. Device is in production to support existing customers, but TI does not recommend using this part in a new design.

**PREVIEW:** Device has been announced but is not in production. Samples may or may not be available.

**OBSELETE:** TI has discontinued the production of the device.

(2) **RoHS:** TI defines "RoHS" to mean semiconductor products that are compliant with the current EU RoHS requirements for all 10 RoHS substances, including the requirement that RoHS substance do not exceed 0.1% by weight in homogeneous materials. Where designed to be soldered at high temperatures, "RoHS" products are suitable for use in specified lead-free processes. TI may reference these types of products as "Pb-Free".

**RoHS Exempt:** TI defines "RoHS Exempt" to mean products that contain lead but are compliant with EU RoHS pursuant to a specific EU RoHS exemption.

**Green:** TI defines "Green" to mean the content of Chlorine (Cl) and Bromine (Br) based flame retardants meet JS709B low halogen requirements of <=1000ppm threshold. Antimony trioxide based flame retardants must also meet the <=1000ppm threshold requirement.

(3) MSL, Peak Temp. - The Moisture Sensitivity Level rating according to the JEDEC industry standard classifications, and peak solder temperature.

(4) There may be additional marking, which relates to the logo, the lot trace code information, or the environmental category on the device.

(5) Multiple Device Markings will be inside parentheses. Only one Device Marking contained in parentheses and separated by a "-" will appear on a device. If a line is indented then it is a continuation of the previous line and the two combined represent the entire Device Marking for that device.

<sup>(6)</sup> Lead finish/Ball material - Orderable Devices may have multiple material finish options. Finish options are separated by a vertical ruled line. Lead finish/Ball material values may wrap to two lines if the finish value exceeds the maximum column width.

**Important Information and Disclaimer:**The information provided on this page represents TI's knowledge and belief as of the date that it is provided. TI bases its knowledge and belief on information provided by third parties, and makes no representation or warranty as to the accuracy of such information. Efforts are underway to better integrate information from third parties. TI has taken and continues to take reasonable steps to provide representative and accurate information but may not have conducted destructive testing or chemical analysis on incoming materials and chemicals. TI and TI suppliers consider certain information to be proprietary, and thus CAS numbers and other limited information may not be available for release.

In no event shall TI's liability arising out of such information exceed the total purchase price of the TI part(s) at issue in this document sold by TI to Customer on an annual basis.

**TAPE AND REEL INFORMATION**

**QUADRANT ASSIGNMENTS FOR PIN 1 ORIENTATION IN TAPE**

\*All dimensions are nominal

Device	Package Type	Package Drawing	Pins	SPQ	Reel Diameter (mm)	Reel Width W1 (mm)	A0 (mm)	B0 (mm)	K0 (mm)	P1 (mm)	W (mm)	Pin1 Quadrant
TLV75101PDSQR	WSON	DSQ	10	3000	180.0	8.4	2.3	2.3	1.15	4.0	8.0	Q2
TLV75101PDSQT	WSON	DSQ	10	250	180.0	8.4	2.3	2.3	1.15	4.0	8.0	Q2
TLV751120280PDSQR	WSON	DSQ	10	3000	180.0	8.4	2.3	2.3	1.15	4.0	8.0	Q2
TLV751180280PDSQR	WSON	DSQ	10	3000	180.0	8.4	2.3	2.3	1.15	4.0	8.0	Q2
TLV751180300PDSQR	WSON	DSQ	10	3000	180.0	8.4	2.3	2.3	1.15	4.0	8.0	Q2
TLV751180330PDSQR	WSON	DSQ	10	3000	180.0	8.4	2.3	2.3	1.15	4.0	8.0	Q2
TLV751330500PDSQR	WSON	DSQ	10	3000	180.0	8.4	2.3	2.3	1.15	4.0	8.0	Q2

**TAPE AND REEL BOX DIMENSIONS**

\*All dimensions are nominal

Device	Package Type	Package Drawing	Pins	SPQ	Length (mm)	Width (mm)	Height (mm)
TLV75101PDSQR	WSON	DSQ	10	3000	210.0	185.0	35.0
TLV75101PDSQT	WSON	DSQ	10	250	210.0	185.0	35.0
TLV751120280PDSQR	WSON	DSQ	10	3000	210.0	185.0	35.0
TLV751180280PDSQR	WSON	DSQ	10	3000	210.0	185.0	35.0
TLV751180300PDSQR	WSON	DSQ	10	3000	210.0	185.0	35.0
TLV751180330PDSQR	WSON	DSQ	10	3000	210.0	185.0	35.0
TLV751330500PDSQR	WSON	DSQ	10	3000	210.0	185.0	35.0





# EXAMPLE STENCIL DESIGN

DSQ0010A

WSON - 0.8 mm max height

PLASTIC SMALL OUTLINE - NO LEAD



SOLDER PASTE EXAMPLE  
BASED ON 0.125 MM THICK STENCIL  
SCALE: 20X

EXPOSED PAD 11  
87% PRINTED SOLDER COVERAGE BY AREA UNDER PACKAGE

4218906/A 04/2019

NOTES: (continued)

6. Laser cutting apertures with trapezoidal walls and rounded corners may offer better paste release. IPC-7525 may have alternate design recommendations.

## 重要声明和免责声明

TI 提供技术和可靠性数据（包括数据表）、设计资源（包括参考设计）、应用或其他设计建议、网络工具、安全信息和其他资源，不保证没有瑕疵且不做任何明示或暗示的担保，包括但不限于对适销性、某特定用途方面的适用性或不侵犯任何第三方知识产权的暗示担保。

这些资源可供使用 TI 产品进行设计的熟练开发人员使用。您将自行承担以下全部责任：(1) 针对您的应用选择合适的 TI 产品，(2) 设计、验证并测试您的应用，(3) 确保您的应用满足相应标准以及任何其他安全、安保或其他要求。这些资源如有变更，恕不另行通知。TI 授权您仅可将这些资源用于研发本资源所述的 TI 产品的应用。严禁对这些资源进行其他复制或展示。您无权使用任何其他 TI 知识产权或任何第三方知识产权。您应全额赔偿因在这些资源的使用中对 TI 及其代表造成的任何索赔、损害、成本、损失和债务，TI 对此概不负责。

TI 提供的产品受 TI 的销售条款 (<https://www.ti.com.cn/zh-cn/legal/termsofsale.html>) 或 [ti.com.cn](https://www.ti.com.cn) 上其他适用条款/TI 产品随附的其他适用条款的约束。TI 提供这些资源并不会扩展或以其他方式更改 TI 针对 TI 产品发布的适用的担保或担保免责声明。

邮寄地址：上海市浦东新区世纪大道 1568 号中建大厦 32 楼，邮政编码：200122  
Copyright © 2021 德州仪器半导体技术（上海）有限公司



## X-ON Electronics

Largest Supplier of Electrical and Electronic Components

*Click to view similar products for [LDO Voltage Regulators](#) category:*

*Click to view products by [Texas Instruments](#) manufacturer:*

Other Similar products are found below :

[AP7363-SP-13](#) [NCV8664CST33T3G](#) [L79M05TL-E](#) [AP7362-HA-7](#) [PT7M8202B12TA5EX](#) [TCR3DF185,LM\(CT](#) [TLF4949EJ](#)  
[NCP4687DH15T1G](#) [NCV8703MX30TCG](#) [LP2951CN](#) [NCV4269CPD50R2G](#) [AP7315-25W5-7](#) [NCV47411PAAJR2G](#) [AP2111H-1.2TRG1](#)  
[ZLDO1117QK50TC](#) [AZ1117ID-ADJTRG1](#) [NCV4263-2CPD50R2G](#) [NCP114BMX075TCG](#) [MC33269T-3.5G](#) [TLE4471GXT](#) [AP7315-33SA-](#)  
[7](#) [NCV4266-2CST33T3G](#) [NCP715SQ15T2G](#) [NCV8623MN-50R2G](#) [NCV563SQ18T1G](#) [NCV8664CDT33RKG](#) [NCV4299CD250R2G](#)  
[NCP715MX30TBG](#) [NCV8702MX25TCG](#) [TLE7270-2E](#) [NCV562SQ25T1G](#) [AP2213D-3.3TRG1](#) [AP2202K-2.6TRE1](#)  
[NCV8170BMX300TCG](#) [NCV8152MX300180TCG](#) [NCP700CMT45TBG](#) [AP7315-33W5-7](#) [NCP154MX180300TAG](#) [AP2113AMTR-G1](#)  
[NJW4104U2-33A-TE1](#) [MP2013AGG-5-P](#) [NCV8775CDT50RKG](#) [NJM2878F3-45-TE1](#) [S-19214B00A-V5T2U7](#) [S-19214B50A-V5T2U7](#) [S-](#)  
[19213B50A-V5T2U7](#) [S-19214BC0A-E8T1U7\\*1](#) [S-19213B00A-V5T2U7](#) [S-19213B33A-V5T2U7](#) [S-19213BC0A-V5T2U7](#)