

TLV757P 1-A、低 I_Q 、小尺寸、低压降稳压器

1 特性

- 输入电压范围：1.45V 至 5.5V
- 可用固定输出电压范围：
 - 0.6V 至 5V（阶跃为 50mV）
- 低 I_Q ：25 μ A（典型值）
- 低压降：
 - 1A 电流时为 425mV（最大值）(3.3V_{OUT})
- 输出精度：1%（最大值）
- 内置软启动功能，具有单调 V_{OUT} 上升
- 折返电流限制
- 有源输出放电
- 高 PSRR：100kHz 时为 45dB
- 与 1 μ F 陶瓷输出电容器搭配使用时可保持稳定
- 封装：
 - SOT-23-5（预览）
 - 2mm x 2mm (WSO6-6)

2 应用

- 机顶盒、电视和游戏机
- 便携式和电池供电类设备
- 台式机、笔记本和超级本
- 平板电脑和遥控器
- 白色家电和电器
- 电网基础设施和保护继电器
- 摄像头模块和图像传感器

3 说明

TLV757P 低压降稳压器 (LDO) 是一款超小型低静态电流 LDO，可提供 1A 拉电流，具有良好的线路和负载瞬态性能。经优化的 TLV757P 可支持 1.45V 至 5.5V 的输入电压范围从而适用于各种应用。为最大程度地降低成本和解决方案尺寸，该器件在 0.6V 至 5V 范围内以固定输出电压的形式提供，以支持现代 MCU 更低的内核电压。此外，TLV757P 具备带有使能功能的低 I_Q ，从而可将待机功耗降至最低。该器件具有内部软启动功能，旨在降低浪涌电流，该电流将为负载提供受控电压并在启动过程中最大程度地降低输入电压压降。关断时，该器件可主动下拉输出以快速释放输出并确保已知的启动状态。

TLV757P 在与支持小尺寸总体解决方案的小型陶瓷输出电容器搭配使用时，可保持稳定。高精度带隙与误差放大器支持 1% 的典型精度。所有器件版本均具有集成的热关断保护、电流限制和低压锁定 (UVLO) 功能。TLV757P 包含一个内部过流保护限制，有助于在短路事件中减少热耗散。

器件信息(1)

器件型号	封装	封装尺寸 (标称值)
TLV757P	SON (6)	2.00mm x 2.00mm
	SOT-23 (5) (预览)	2.90mm x 1.60mm

(1) 如需了解所有可用封装，请参阅数据表末尾的可订购产品附录。

典型应用

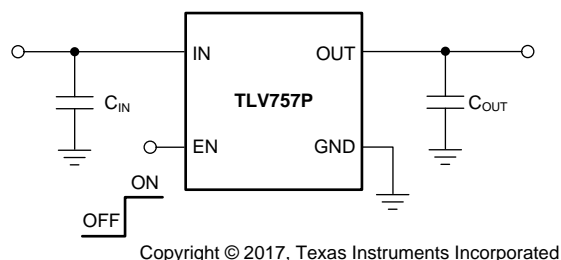

启动波形

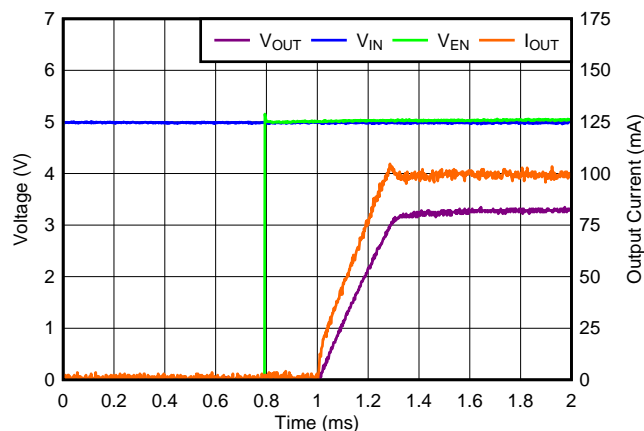

目录

1	特性	1	7.4	Device Functional Modes	14
2	应用	1	8	Application and Implementation	15
3	说明	1	8.1	Application Information	15
4	修订历史记录	2	8.2	Typical Application	19
5	Pin Configuration and Functions	3	9	Power Supply Recommendations	20
6	Specifications	4	10	Layout	21
6.1	Absolute Maximum Ratings	4	10.1	Layout Guidelines	21
6.2	ESD Ratings	4	10.2	Layout Examples	21
6.3	Recommended Operating Conditions	4	11	器件和文档支持	22
6.4	Thermal Information	4	11.1	器件支持	22
6.5	Electrical Characteristics	5	11.2	接收文档更新通知	22
6.6	Typical Characteristics	7	11.3	社区资源	22
7	Detailed Description	12	11.4	商标	22
7.1	Overview	12	11.5	静电放电警告	22
7.2	Functional Block Diagram	12	11.6	Glossary	22
7.3	Feature Description	12	12	机械、封装和可订购信息	22

4 修订历史记录

注：之前版本的页码可能与当前版本有所不同。

Changes from Original (October 2017) to Revision A

Page

•	将 DRV 封装状态发布为生产	1
---	-----------------------	----------

5 Pin Configuration and Functions

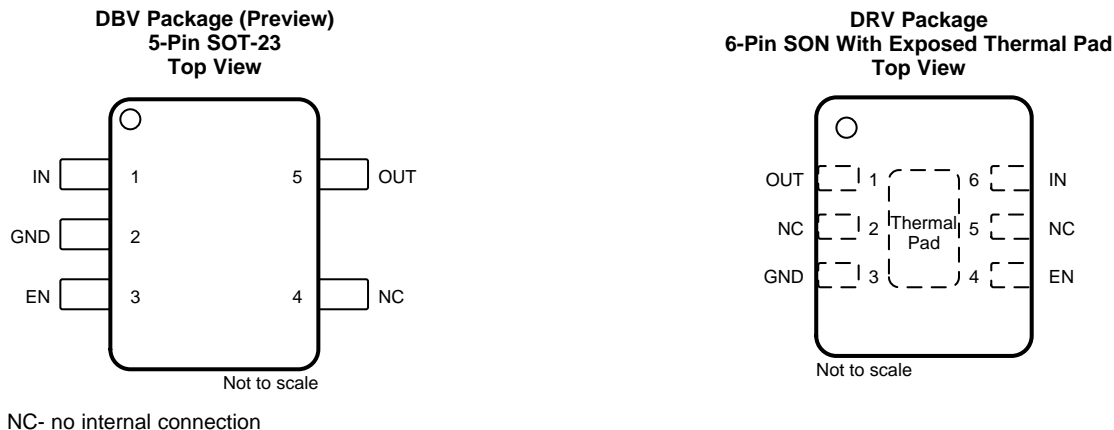

Pin Functions

NAME	PIN		I/O	DESCRIPTION
	DBV	DRV		
EN	3	4	I	Enable pin. Drive EN greater than V_{HI} to turn on the regulator. Drive EN less than V_{LO} to place the LDO into shutdown mode.
GND	2	3	—	Ground pin
IN	1	6	I	Input pin. A capacitor with a value of 1 μF or larger is required from this pin to ground ⁽¹⁾ . See the Input and Output Capacitor Selection section for more information.
NC	4	2, 5	—	No internal connection
OUT	5	1	O	Regulated output voltage pin. A capacitor with a value of 1 μF or larger is required from this pin to ground ⁽¹⁾ . See the Input and Output Capacitor Selection section for more information.
Thermal pad	—	Pad	—	Connect the thermal pad to a large-area ground plane. The thermal pad is internally connected to GND.

(1) The nominal input and output capacitance must be greater than 0.47 μF ; throughout this document the nominal derating on these capacitors is 50%. Take care to ensure that the effective capacitance at the pin is greater than 0.47 μF .

6 Specifications

6.1 Absolute Maximum Ratings

 over operating free-air temperature range (unless otherwise noted)⁽¹⁾

	MIN	MAX	UNIT
Supply voltage, V_{IN}	-0.3	6	V
Enable voltage, V_{EN}	-0.3	6	V
Output voltage, V_{OUT}	-0.3	$V_{IN} + 0.3$ ⁽²⁾	V
Operating junction temperature range, T_J	-40	150	°C
Storage temperature, T_{stg}	-65	150	°C

- (1) Stresses beyond those listed under *Absolute Maximum Ratings* may cause permanent damage to the device. These are stress ratings only, which do not imply functional operation of the device at these or any other conditions beyond those indicated under *Recommended Operating Conditions*. Exposure to absolute-maximum-rated conditions for extended periods may affect device reliability.
- (2) The absolute maximum rating is $V_{IN} + 0.3$ V or 6 V, whichever is smaller

6.2 ESD Ratings

		VALUE	UNIT
$V_{(ESD)}$ Electrostatic discharge	Human-body model (HBM), per ANSI/ESDA/JEDEC JS-001 ⁽¹⁾	±1000	V
	Charged-device model (CDM), per JEDEC specification JESD22-C101 ⁽²⁾	±500	

- (1) JEDEC document JEP155 states that 500-V HBM allows safe manufacturing with a standard ESD control process. Manufacturing with less than 500-V HBM is possible with the necessary precautions.
- (2) JEDEC document JEP157 states that 250-V CDM allows safe manufacturing with a standard ESD control process. Manufacturing with less than 250-V CDM is possible with the necessary precautions.

6.3 Recommended Operating Conditions

over operating free-air temperature range (unless otherwise noted)

		MIN	NOM	MAX	UNIT
V_{IN}	Input voltage	1.45		5.5	V
V_{OUT}	Output voltage	0.6		5	V
V_{EN}	Enable voltage	0		5.5	V
I_{OUT}	Output current	0		1	A
C_{IN}	Input capacitor	1			µF
C_{OUT}	Output capacitor	1		200	µF
f_{EN}	Enable toggle frequency			10	kHz
T_J	Junction temperature	-40		125	°C

6.4 Thermal Information

THERMAL METRIC ⁽¹⁾		TLV757		UNIT
		DBV (SOT-23)	DRV (SON)	
		5 PINS	6 PINS	
$R_{\theta JA}$	Junction-to-ambient thermal resistance	231.1	100.2	°C/W
$R_{\theta JC(top)}$	Junction-to-case (top) thermal resistance	118.4	108.5	°C/W
$R_{\theta JB}$	Junction-to-board thermal resistance	64.4	64.3	°C/W
Ψ_{JT}	Junction-to-top characterization parameter	28.4	10.4	°C/W
Ψ_{JB}	Junction-to-board characterization parameter	63.8	64.8	°C/W
$R_{\theta JC(bot)}$	Junction-to-case (bottom) thermal resistance	N/A	34.7	°C/W

- (1) For more information about traditional and new thermal metrics, see the [Semiconductor and IC Package Thermal Metrics](#) application report.

6.5 Electrical Characteristics

over operating free-air temperature range ($T_J = -40^\circ\text{C}$ to $+125^\circ\text{C}$), $V_{IN} = V_{OUT} + 0.5\text{ V}$ or 1.45 V (whichever is greater), $I_{OUT} = 1\text{ mA}$, $V_{EN} = V_{IN}$, and $C_{IN} = C_{OUT} = 1\text{ }\mu\text{F}$ (unless otherwise noted); all typical values are at $T_J = 25^\circ\text{C}$.

PARAMETER	TEST CONDITIONS	MIN	TYP	MAX	UNIT		
V_{IN}	Input voltage	1.45		5.5	V		
V_{OUT}	Output voltage	0.6		5	V		
Output accuracy	$-40^\circ\text{C} \leq T_J \leq 85^\circ\text{C}$, $V_{OUT} \geq 1\text{ V}$	-1%		1%			
	$-40^\circ\text{C} \leq T_J \leq 85^\circ\text{C}$, $0.6\text{ V} \leq V_{OUT} < 1\text{ V}$	-10		10	mV		
	$V_{OUT} \geq 1\text{ V}$	-1.5%		1.5%			
	$0.6\text{ V} \leq V_{OUT} < 1\text{ V}$	-15		15	mV		
$(\Delta V_{OUT})/\Delta V_{IN}$	Line regulation $V_{OUT} + 0.5\text{ V}^{(1)} \leq V_{IN} \leq 5.5\text{ V}$		2		mV		
$\Delta V_{OUT}/\Delta I_{OUT}$ T	Load regulation $0.1\text{ mA} \leq I_{OUT} \leq 1\text{ A}$, $V_{IN} \geq 2.4\text{ V}$	DRV package	0.044		V/A		
		DBV package	0.060				
I_{GND}	Ground current $T_J = 25^\circ\text{C}$		25	31	μA		
		$-40^\circ\text{C} \leq T_J \leq +85^\circ\text{C}$		33			
		$-40^\circ\text{C} \leq T_J \leq +125^\circ\text{C}$		40			
I_{SHDN}	Shutdown current $V_{EN} \leq 0.4\text{ V}$, $1.45\text{ V} \leq V_{IN} \leq 5.5\text{ V}$, $-40^\circ\text{C} \leq T_J \leq +125^\circ\text{C}$		0.1	1	μA		
I_{CL}	Output current limit $V_{IN} = V_{OUT} + V_{DO(MAX)} + 0.25\text{ V}$	$V_{OUT} = V_{OUT} - 0.2\text{ V}$, $V_{OUT} \leq 1.5\text{ V}$	1.2	1.55	1.78	A	
		$V_{OUT} = 0.9 \times V_{OUT}$, $1.5\text{ V} < V_{OUT} \leq 4.5\text{ V}$					
I_{SC}	Short circuit current limit $V_{OUT} = 0\text{ V}$, $V_{IN} = V_{OUT} + V_{DO(MAX)} + 0.25\text{ V}$		755		mA		
V_{DO}	Dropout voltage $I_{OUT} = 1\text{ A}$, $-40^\circ\text{C} \leq T_J \leq +85^\circ\text{C}$	$0.6\text{ V} \leq V_{OUT} < 0.8\text{ V}$		1350	1400	mV	
		$0.8\text{ V} \leq V_{OUT} < 1\text{ V}$		1200	1300	mV	
		$1\text{ V} \leq V_{OUT} < 1.2\text{ V}$		1100	1150	mV	
		$1.2\text{ V} \leq V_{OUT} < 1.5\text{ V}$		1000	1050	mV	
		$1.5\text{ V} \leq V_{OUT} < 1.8\text{ V}$		700	800	mV	
		$1.8\text{ V} \leq V_{OUT} < 2.5\text{ V}$		650	750	mV	
		$2.5\text{ V} \leq V_{OUT} < 3.3\text{ V}$		500	600	mV	
		$3.3\text{ V} \leq V_{OUT} < 5.0\text{ V}$		300	425	mV	
		$I_{OUT} = 1\text{ A}$, $-40^\circ\text{C} \leq T_J \leq +125^\circ\text{C}$	$0.6\text{ V} \leq V_{OUT} < 0.8\text{ V}$			1450	mV
			$0.8\text{ V} \leq V_{OUT} < 1\text{ V}$			1350	mV
			$1\text{ V} \leq V_{OUT} < 1.2\text{ V}$			1200	mV
			$1.2\text{ V} \leq V_{OUT} < 1.5\text{ V}$			1100	mV
			$1.5\text{ V} \leq V_{OUT} < 1.8\text{ V}$			850	mV
			$1.8\text{ V} \leq V_{OUT} < 2.5\text{ V}$			800	mV
			$2.5\text{ V} \leq V_{OUT} < 3.3\text{ V}$			650	mV
			$3.3\text{ V} \leq V_{OUT} < 5.0\text{ V}$			475	mV
PSRR	Power supply rejection ratio $f = 1\text{ kHz}$, $V_{IN} = V_{OUT} + 1\text{ V}$, $I_{OUT} = 50\text{ mA}$		52		dB		
		$f = 100\text{ kHz}$, $V_{IN} = V_{OUT} + 1\text{ V}$, $I_{OUT} = 50\text{ mA}$	46				
		$f = 1\text{ MHz}$, $V_{IN} = V_{OUT} + 1\text{ V}$, $I_{OUT} = 50\text{ mA}$	52				
V_n	Output noise voltage $BW = 10\text{ Hz to } 100\text{ kHz}$, $V_{OUT} = 1.2\text{ V}$, $I_{OUT} = 1\text{ A}$		71.5		μV_{RMS}		
V_{UVLO}	Undervoltage lockout V_{IN} rising	1.21	1.3	1.44	V		
$V_{UVLO, HYST}$	Undervoltage lockout hysteresis V_{IN} falling		40		mV		
t_{STR}	Startup time		550		μs		
V_{HI}	EN pin high voltage (enabled)	1			V		

(1) $V_{IN} = 1.45\text{ V}$ for $V_{OUT} < 0.9\text{ V}$

Electrical Characteristics (continued)

over operating free-air temperature range ($T_J = -40^{\circ}\text{C}$ to $+125^{\circ}\text{C}$), $V_{IN} = V_{OUT} + 0.5\text{ V}$ or 1.45 V (whichever is greater), $I_{OUT} = 1\text{ mA}$, $V_{EN} = V_{IN}$, and $C_{IN} = C_{OUT} = 1\text{ }\mu\text{F}$ (unless otherwise noted); all typical values are at $T_J = 25^{\circ}\text{C}$.

PARAMETER		TEST CONDITIONS	MIN	TYP	MAX	UNIT
V_{LO}	EN pin low voltage (enabled)				0.3	V
I_{EN}	Enable pin current	$V_{IN} = 5.5\text{ V}$, $EN = 5.5\text{ V}$		10		nA
$R_{PULLDOWN}$	Pulldown resistance	$V_{IN} = 3.3\text{ V}$ (P version only)		95		Ω
T_{SD}	Thermal shutdown	Shutdown, temperature increasing		165		$^{\circ}\text{C}$
		Reset, temperature decreasing		155		$^{\circ}\text{C}$

6.6 Typical Characteristics

at operating temperature $T_J = 25^\circ\text{C}$, $V_{IN} = V_{OUT(NOM)} + 0.5\text{ V}$ or 1.45 V (whichever is greater), $I_{OUT} = 1\text{ mA}$, $V_{EN} = V_{IN}$, and $C_{IN} = C_{OUT} = 1\ \mu\text{F}$ (unless otherwise noted)



图 1. PSRR vs I_{OUT}



图 2. PSRR vs V_{IN}

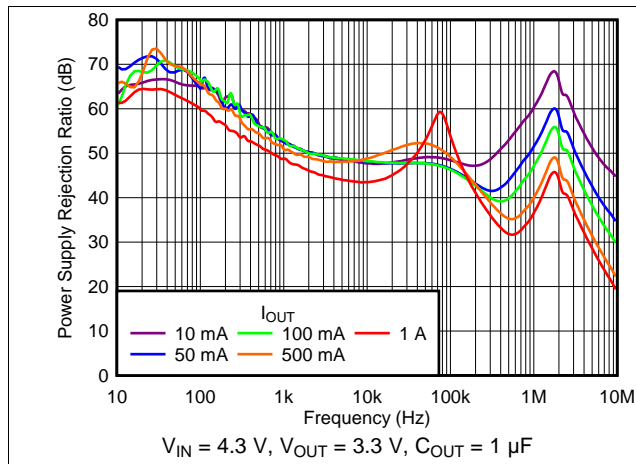

图 3. PSRR vs C_{OUT}

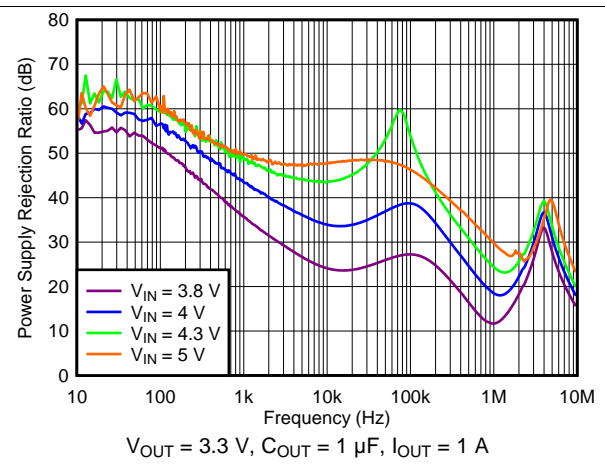

图 4. Output Spectral Noise Density

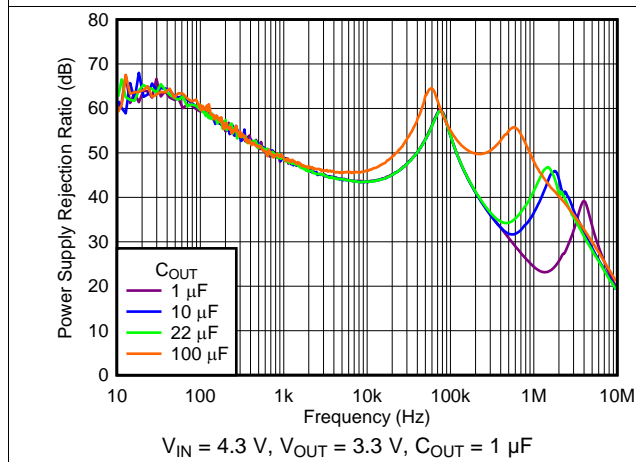

图 5. Output Spectral Noise Density

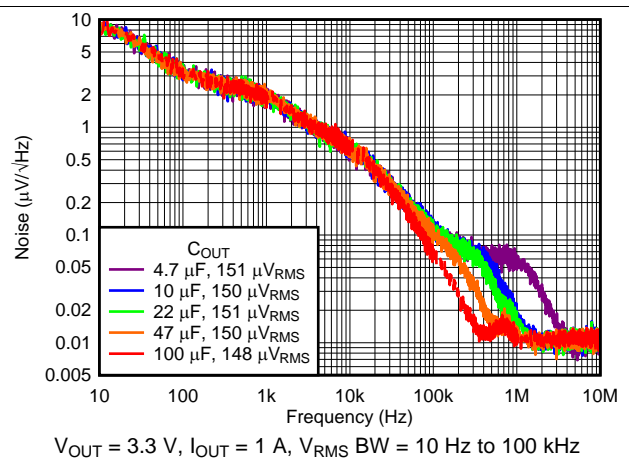

图 6. Output Noise vs Frequency and V_{OUT}

Typical Characteristics (接下页)

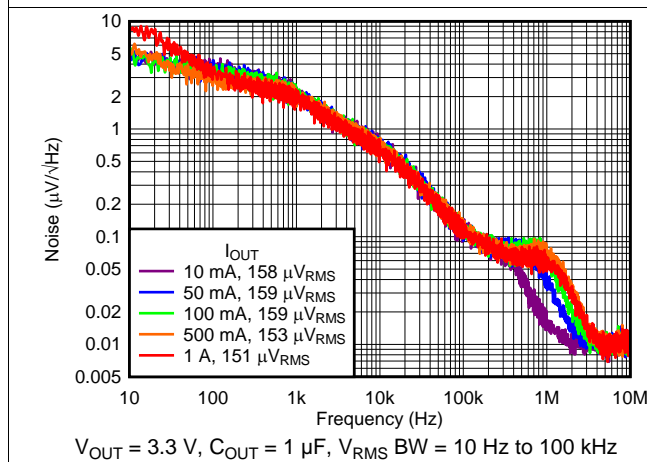
at operating temperature $T_J = 25^\circ\text{C}$, $V_{IN} = V_{OUT(NOM)} + 0.5\text{ V}$ or 1.45 V (whichever is greater), $I_{OUT} = 1\text{ mA}$, $V_{EN} = V_{IN}$, and $C_{IN} = C_{OUT} = 1\text{ }\mu\text{F}$ (unless otherwise noted)

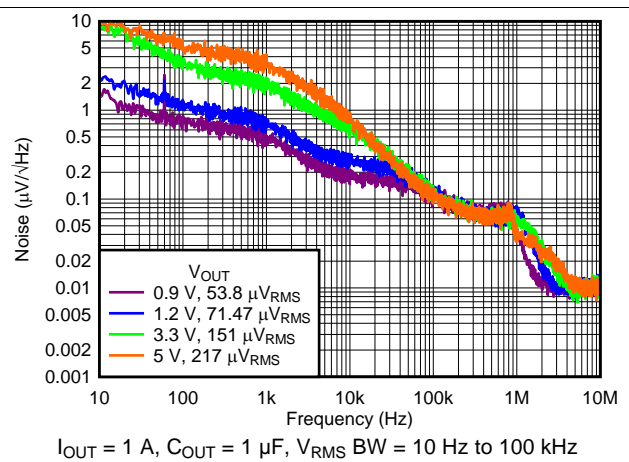
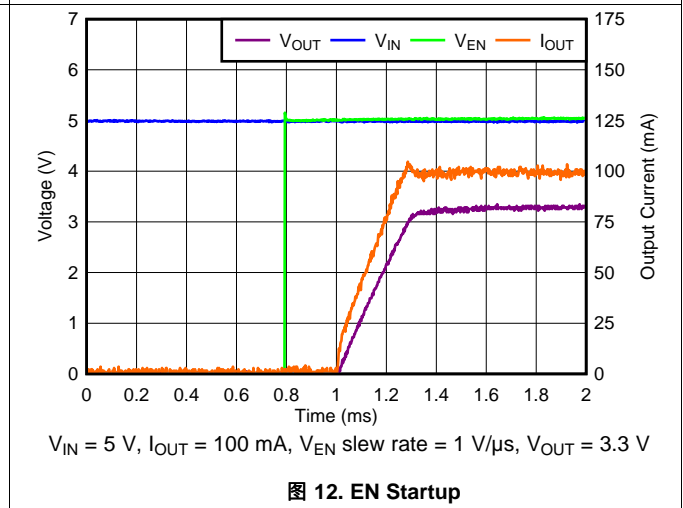
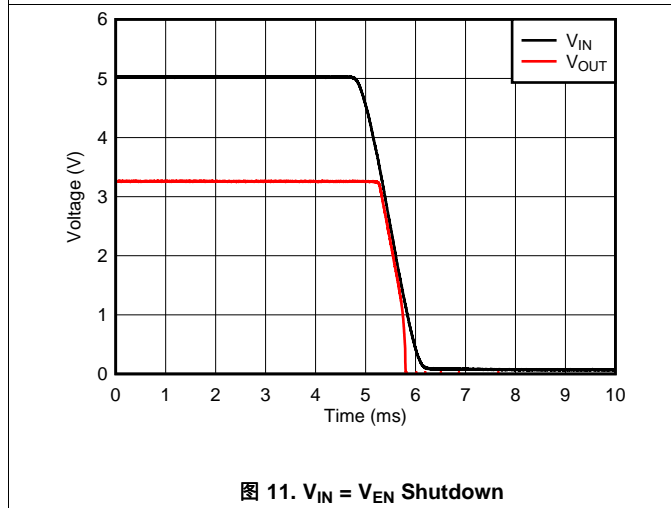
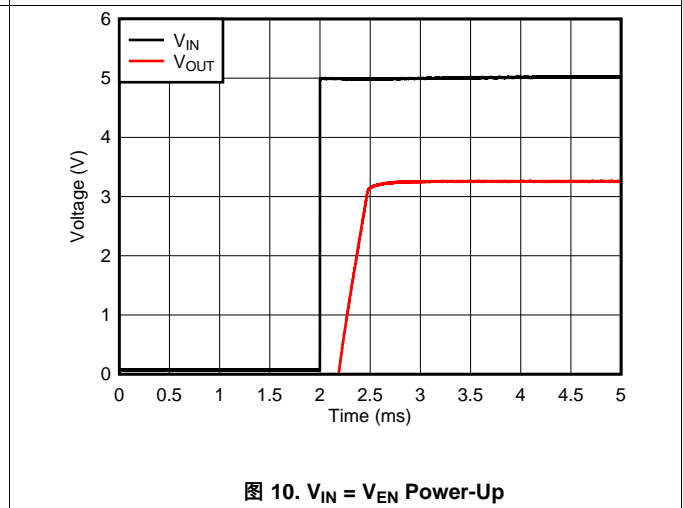
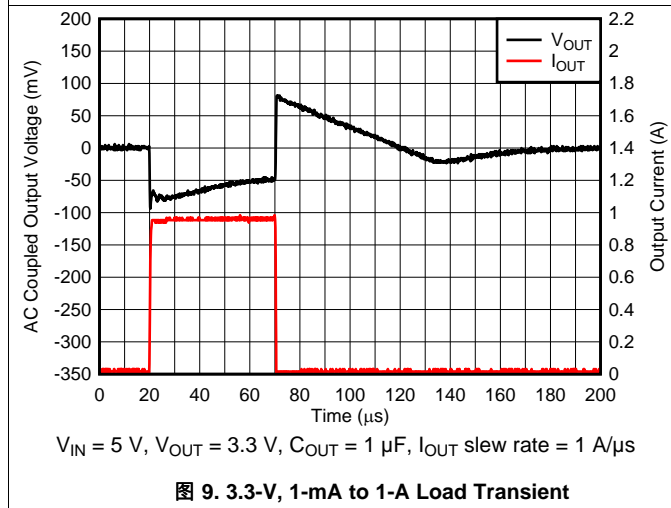
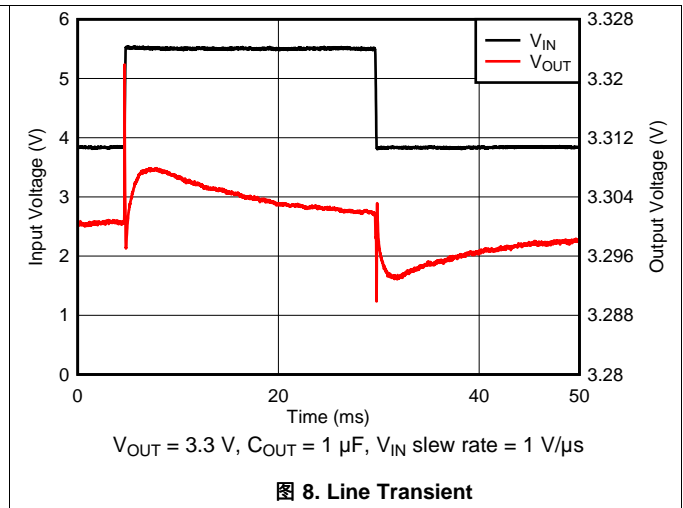
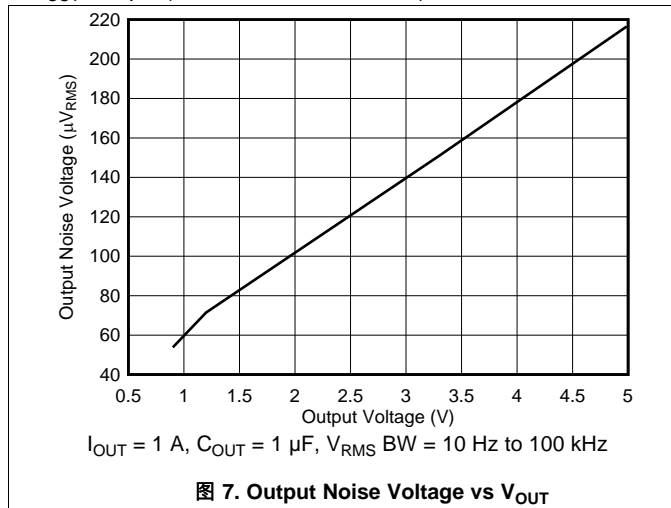

Typical Characteristics (接下页)

at operating temperature $T_J = 25^\circ\text{C}$, $V_{IN} = V_{OUT(NOM)} + 0.5\text{ V}$ or 1.45 V (whichever is greater), $I_{OUT} = 1\text{ mA}$, $V_{EN} = V_{IN}$, and $C_{IN} = C_{OUT} = 1\text{ }\mu\text{F}$ (unless otherwise noted)



图 13. Load Regulation vs I_{OUT}



图 14. 3.3-V Dropout Voltage vs I_{OUT}

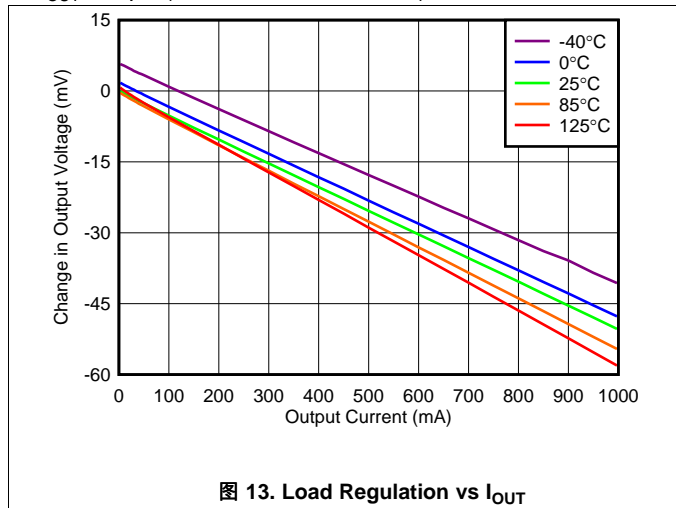

图 15. 5.0-V Dropout Voltage vs I_{OUT}

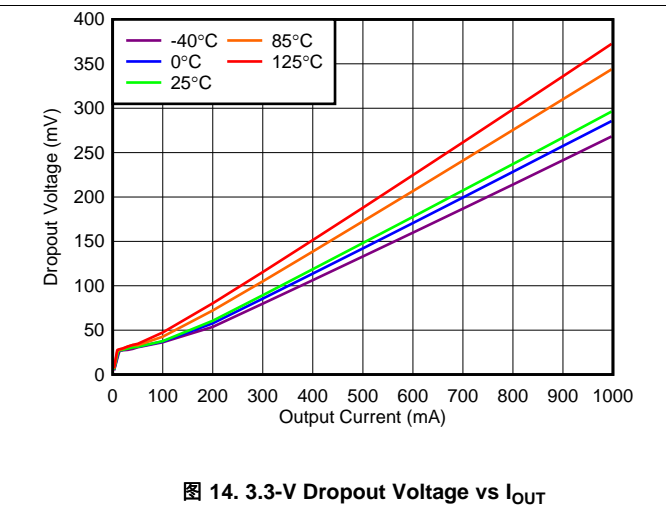

图 16. 3.3 V Regulation vs V_{IN} (Line Regulation)

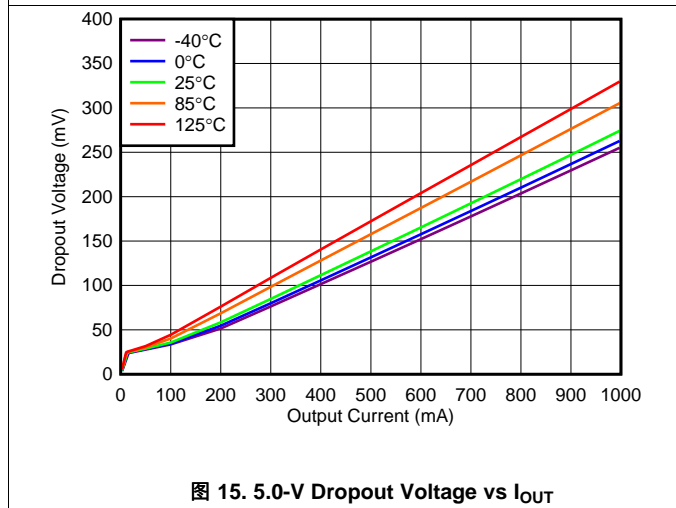

图 17. 5.0-V Accuracy vs V_{IN} (Line Regulation)

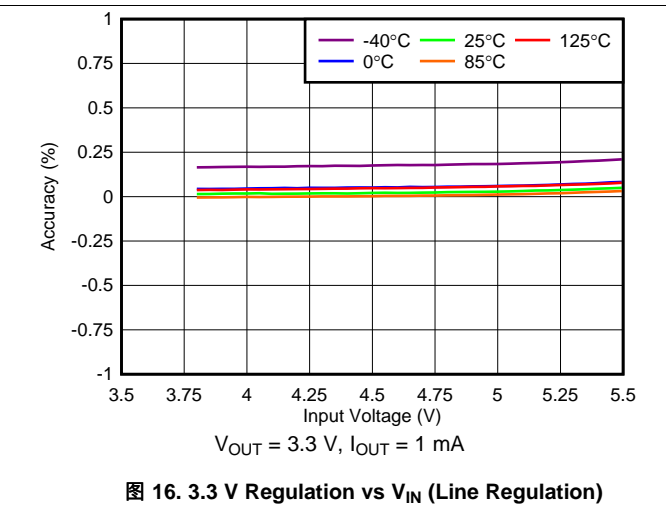

图 18. I_{GND} vs I_{OUT}

Typical Characteristics (接下页)

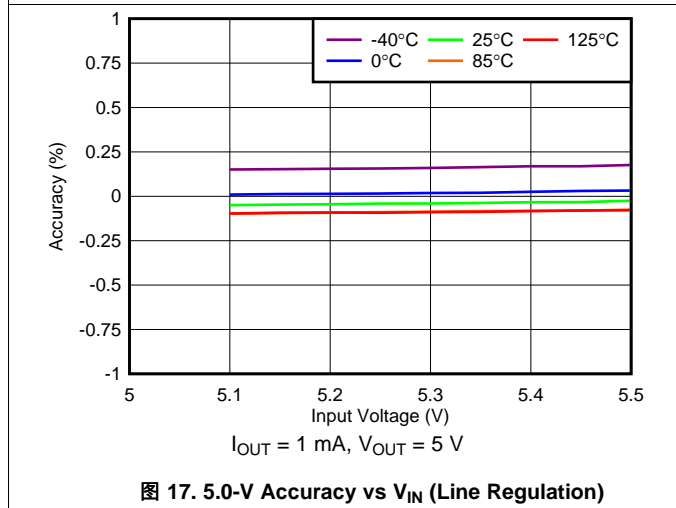
at operating temperature $T_J = 25^\circ\text{C}$, $V_{IN} = V_{OUT(NOM)} + 0.5\text{ V}$ or 1.45 V (whichever is greater), $I_{OUT} = 1\text{ mA}$, $V_{EN} = V_{IN}$, and $C_{IN} = C_{OUT} = 1\text{ }\mu\text{F}$ (unless otherwise noted)

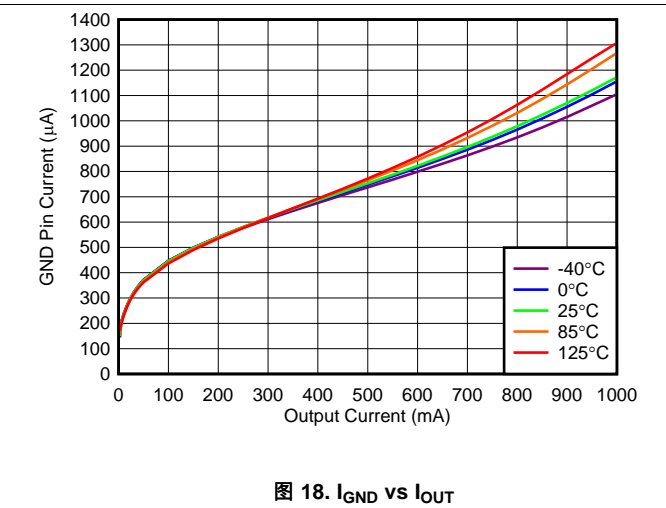

图 19. I_{GND} vs V_{IN}



图 20. I_{GND} vs V_{IN}

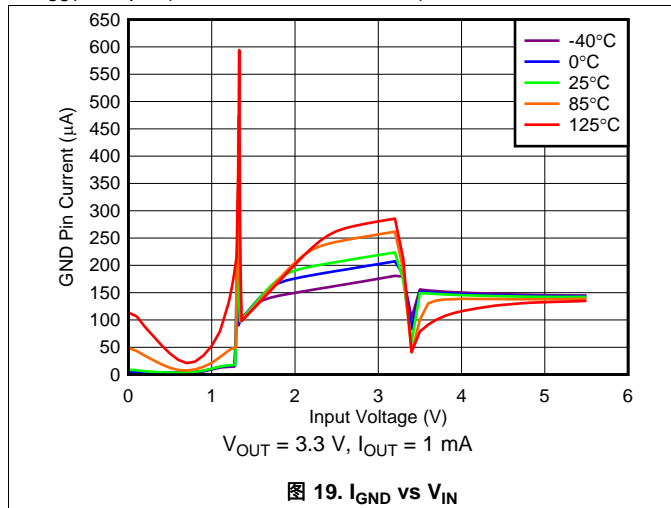

图 21. I_{SHDN} vs V_{IN}

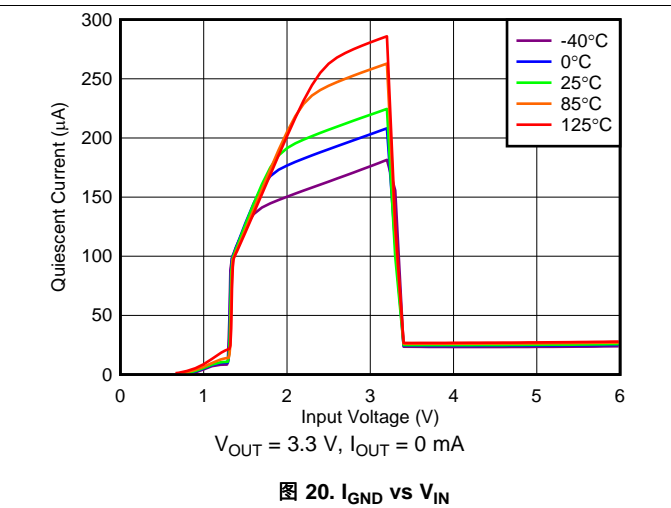

图 22. I_{SHDN} vs Temperature

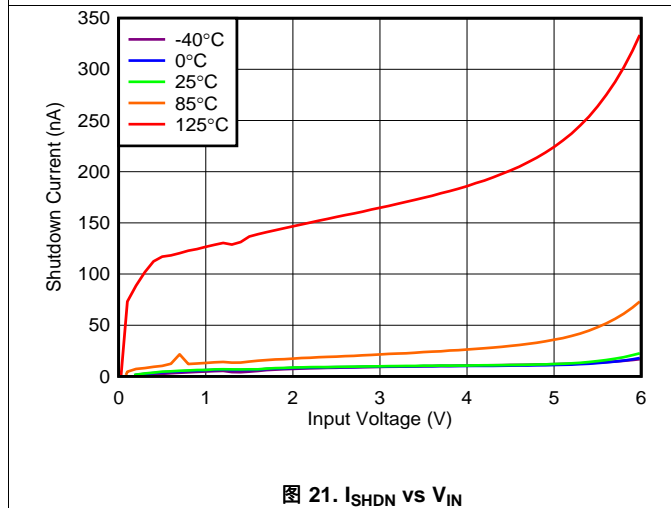

图 23. Enable Threshold vs Temperature

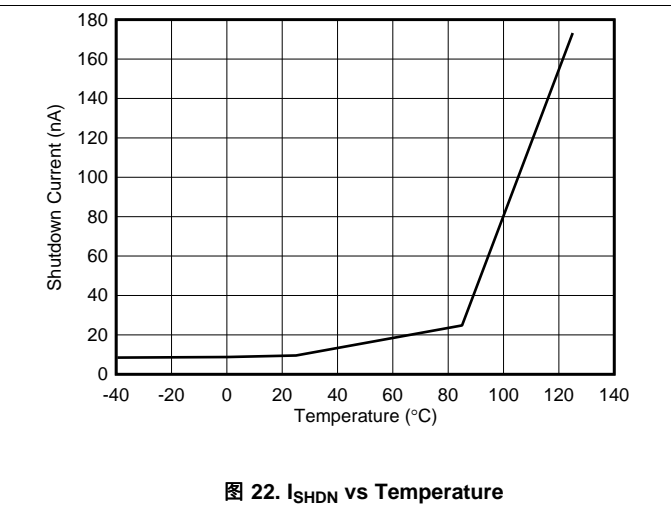

图 24. I_{EN} vs V_{IN}

Typical Characteristics (接下页)

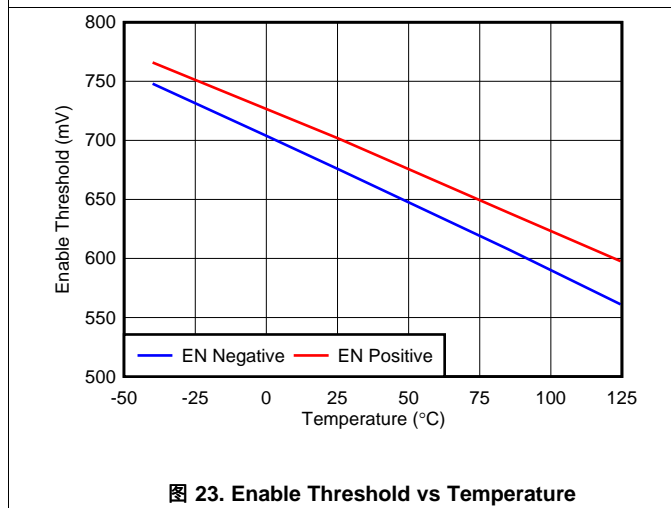
at operating temperature $T_J = 25^\circ\text{C}$, $V_{IN} = V_{OUT(NOM)} + 0.5\text{ V}$ or 1.45 V (whichever is greater), $I_{OUT} = 1\text{ mA}$, $V_{EN} = V_{IN}$, and $C_{IN} = C_{OUT} = 1\ \mu\text{F}$ (unless otherwise noted)

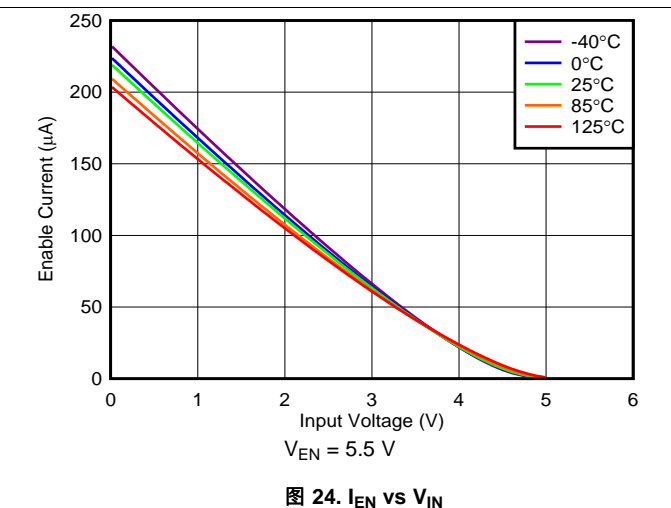

图 25. UVLO Threshold vs Temperature



图 26. IOUT vs VOUT Pulldown Resistor

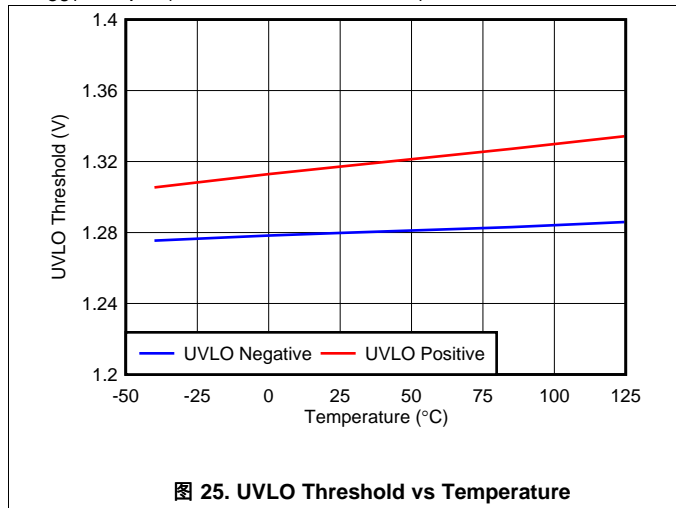

图 27. 3.3-V Foldback Current Limit vs IOUT

7 Detailed Description

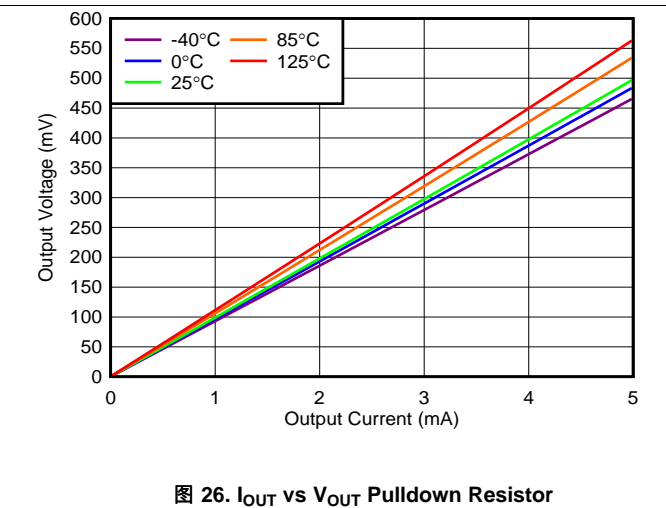
7.1 Overview

The TLV757P belongs to a family of next-generation, low-dropout regulators (LDOs). This device consumes low quiescent current and delivers excellent line and load transient performance. The TLV757P is optimized for wide variety of applications by supporting an input voltage range from 1.4 V to 5.5 V. To minimize cost and solution size, the device is offered in fixed output voltages ranging from 0.6 V to 5 V to support the lower core voltages of modern microcontrollers (MCUs).

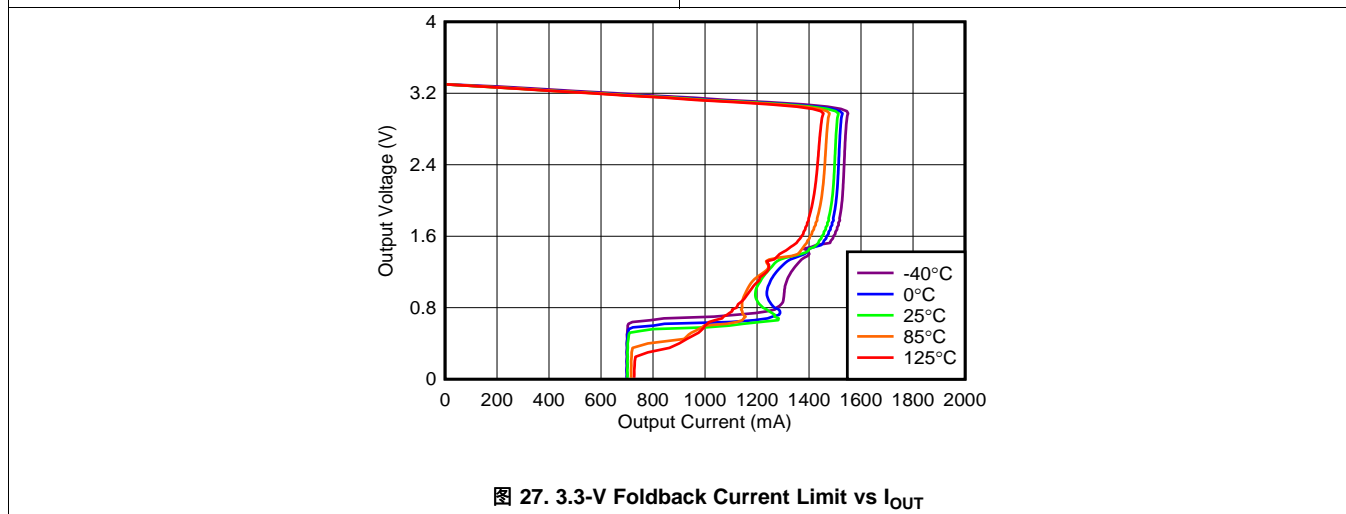
This regulator offers foldback current limit, shutdown, and thermal protection. The operating junction temperature is -40°C to $+125^{\circ}\text{C}$.

7.2 Functional Block Diagram

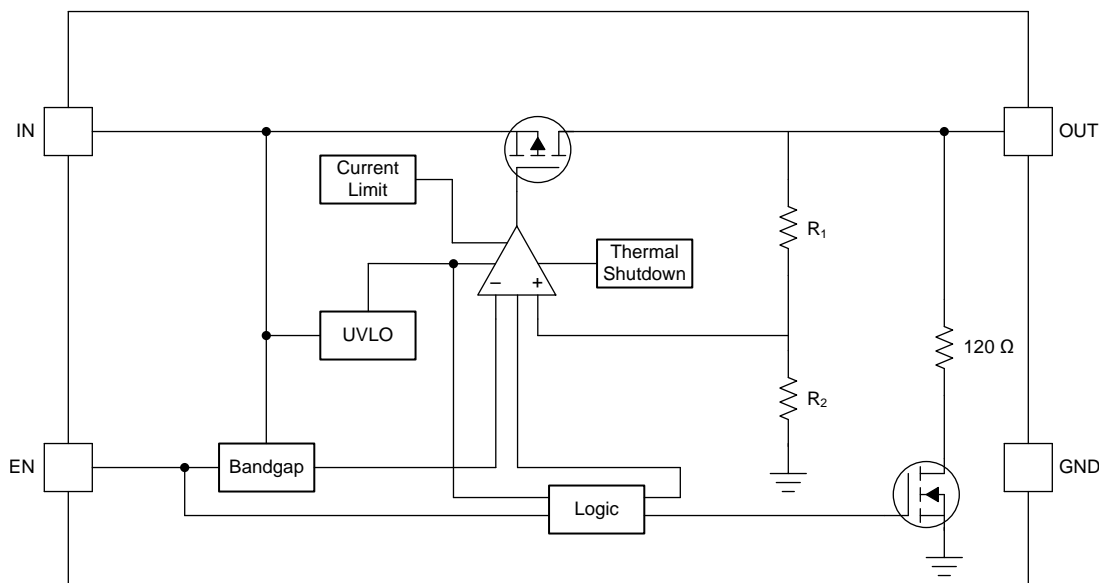

(1) $R_2 = 550\text{ k}\Omega$, $R_1 = \text{adjustable}$.

7.3 Feature Description

7.3.1 Undervoltage Lockout (UVLO)

An undervoltage lockout (UVLO) circuit disables the output until the input voltage is greater than the rising UVLO voltage (V_{UVLO}). This circuit ensures that the device does not exhibit any unpredictable behavior when the supply voltage is lower than the operational range of the internal circuitry. When V_{IN} is less than V_{UVLO} , the output is connected to ground with a $120\text{-}\Omega$ pulldown resistor.

7.3.2 Enable (EN)

The enable pin (EN) is active high. Enable the device by forcing the EN pin to exceed V_{HI} . Turn off the device by forcing the EN pin below V_{LO} . If shutdown capability is not required, connect EN to IN.

The device has an internal pull-down that connects a $120\text{-}\Omega$ resistor to ground when the device is disabled. The discharge time after disabling depends on the output capacitance (C_{OUT}) and the load resistance (R_L) in parallel with the $120\text{-}\Omega$ pulldown resistor. [公式 1](#) calculates the time constant τ :

$$\tau = \frac{120 \cdot R_L}{120 + R_L} \cdot C_{OUT} \quad (1)$$

Feature Description (接下页)

The EN pin is independent of the input pin, but if the EN pin is driven to a higher voltage than V_{IN} , the current into the EN pin increases. This effect is illustrated in 图 24. When the EN voltage is higher than the input voltage there is an increased current flow into the EN pin. If this increased flow causes problems in the application, sequence the EN pin after V_{IN} is high, or to tie EN to V_{IN} to prevent this flow increase from happening. If EN is driven to a higher voltage than V_{IN} , limit the frequency on EN to below 10 kHz.

7.3.3 Internal Foldback Current Limit

The TLV757P has an internal current limit that protects the regulator during fault conditions. The current limit is a hybrid scheme with brick wall until the output voltage is less than $0.4 \times V_{OUT(NOM)}$. When the voltage drops below $0.4 \times V_{OUT(NOM)}$, a foldback current limit is implemented which scales back the current as the output voltage approaches GND. When the output shorts, the LDO supplies a typical current of I_{SC} . The output voltage is not regulated when the device is in current limit. In this condition, the output voltage is the product of the regulated current and the load resistance. When the device output is shorts, the PMOS pass transistor dissipates power $[(V_{IN} - V_{OUT}) \times I_{SC}]$ until thermal shutdown is triggered and the device turns off. After the device cools down, the internal thermal shutdown circuit turns the device back on. If the fault condition continues, the device cycles between current limit and thermal shutdown.

The foldback current-limit circuit limits the current that is allowed through the device to current levels lower than the minimum current limit at nominal V_{OUT} current limit (I_{CL}) during start up. See 图 27 for typical current limit values. If the output is loaded by a constant-current load during start up, or if the output voltage is negative when the device is enabled, then the load current demanded by the load may exceed the foldback current limit and the device may not rise to the full output voltage. For constant-current loads, disable the output load until the output has risen to the nominal voltage.

Excess inductance can cause the current limit to oscillate. Minimize the inductance to keep the current limit from oscillating during a fault condition.

7.3.4 Thermal Shutdown

Thermal shutdown protection disables the output when the junction temperature rises to approximately 165°C. Disabling the device eliminates the power dissipated by the device, allowing the device to cool. When the junction temperature cools to approximately 155°C, the output circuitry is enabled again. Depending on power dissipation, thermal resistance, and ambient temperature, the thermal protection circuit may cycle on and off. This cycling limits regulator dissipation which protects the circuit from damage as a result of overheating.

Activating the thermal shutdown feature usually indicates excessive power dissipation as a result of the product of the $(V_{IN} - V_{OUT})$ voltage and the load current. For reliable operation, limit junction temperature to a maximum of 125°C. To estimate the margin of safety in a complete design, increase the ambient temperature until the thermal protection is triggered; use worst-case loads and signal conditions.

The internal protection circuitry protects against overload conditions but is not intended to be activated in normal operation. Continuously running the device into thermal shutdown degrades device reliability.

7.4 Device Functional Modes

表 1 lists a comparison between the normal, dropout, and disabled modes of operation.

表 1. Device Functional Modes Comparison

OPERATING MODE	PARAMETER			
	V_{IN}	EN	I_{OUT}	T_J
Normal ⁽¹⁾	$V_{IN} > V_{OUT(NOM)} + V_{DO}$	$V_{EN} > V_{HI}$	$I_{OUT} < I_{CL}$	$T_J < T_{SD}$
Dropout ⁽¹⁾	$V_{IN} < V_{OUT(NOM)} + V_{DO}$	$V_{EN} > V_{HI}$	—	$T_J < T_{SD}$
Disabled ⁽²⁾	$V_{IN} < V_{UVLO}$	$V_{EN} < V_{LO}$	—	$T_J > T_{SD}$

(1) All table conditions must be met.

(2) The device is disabled when any condition is met.

7.4.1 Normal Operation

The device regulates to the nominal output voltage when all of the following conditions are met.

- The input voltage is greater than the nominal output voltage plus the dropout voltage ($V_{OUT(NOM)} + V_{DO}$)
- The enable voltage has previously exceeded the enable rising threshold voltage and has not decreased below the enable falling threshold
- The output current is less than the current limit ($I_{OUT} < I_{CL}$)
- The device junction temperature is less than the thermal shutdown temperature ($T_J < T_{SD}$)

7.4.2 Dropout Operation

If the input voltage is lower than the nominal output voltage plus the specified dropout voltage, but all other conditions are met for normal operation, the device operates in dropout. In this mode, the output voltage tracks the input voltage. During this mode, the transient performance of the device degrades because the pass device is in a triode state and no longer controls the output voltage of the LDO. Line or load transients in dropout can result in large output-voltage deviations.

When the device is in a steady dropout state (defined as when the device is in dropout, $V_{IN} < V_{OUT(NOM)} + V_{DO}$, right after being in a normal regulation state, but not during startup), the pass-FET is driven as hard as possible when the control loop is out of balance. During the normal time required for the device to regain regulation, $V_{IN} \geq V_{OUT(NOM)} + V_{DO}$, V_{OUT} can overshoot $V_{OUT(NOM)}$ during fast transients.

7.4.3 Disabled

The output is shut down by forcing the enable pin below V_{LO} . When disabled, the pass device is turned off, internal circuits are shut down, and the output voltage is actively discharged to ground by an internal switch from the output to ground. The active pulldown is on when sufficient input voltage is provided.

8 Application and Implementation

注

Information in the following applications sections is not part of the TI component specification, and TI does not warrant its accuracy or completeness. TI's customers are responsible for determining suitability of components for their purposes. Customers should validate and test their design implementation to confirm system functionality.

8.1 Application Information

8.1.1 Input and Output Capacitor Selection

The TLV757P requires an output capacitance of 0.47 μF or larger for stability. Use X5R- and X7R-type ceramic capacitors because these capacitors have minimal variation in capacitance value and equivalent series resistance (ESR) over temperature. When selecting a capacitor for a specific application, consider the DC bias characteristics for the capacitor. Higher output voltages cause a significant derating of the capacitor. As a general rule, ceramic capacitors must be derated by 50%. For best performance, TI recommends a maximum output capacitance value of 200 μF .

Place a 1 μF or greater capacitor on the input pin of the LDO. Some input supplies have a high impedance. Placing a capacitor on the input supply reduces the input impedance. The input capacitor counteracts reactive input sources and improves transient response and PSRR. If the input supply has a high impedance over a large range of frequencies, several input capacitors are used in parallel to lower the impedance over frequency. Use a higher-value capacitor if large, fast, rise-time load transients are expected, or if the device is located several inches from the input power source.

8.1.2 Dropout Voltage

The TLV757P uses a PMOS pass transistor to achieve low dropout. When $(V_{\text{IN}} - V_{\text{OUT}})$ is less than the dropout voltage (V_{DO}), the PMOS pass device is in the linear region of operation and the input-to-output resistance is the $R_{\text{DS(ON)}}$ of the PMOS pass element. V_{DO} scales linearly with the output current because the PMOS device functions like a resistor in dropout mode. As with any linear regulator, PSRR and transient response degrade as $(V_{\text{IN}} - V_{\text{OUT}})$ approaches dropout operation. See [图 14](#) and [图 15](#) for typical dropout values.

8.1.3 Exiting Dropout

Some applications have transients that place the LDO into dropout, such as slower ramps on V_{IN} during start-up. As with other LDOs, the output may overshoot on recovery from these conditions. A ramping input supply causes an LDO to overshoot on start-up when the slew rate and voltage levels are in the correct range; see [图 28](#). Use an enable signal to avoid this condition.

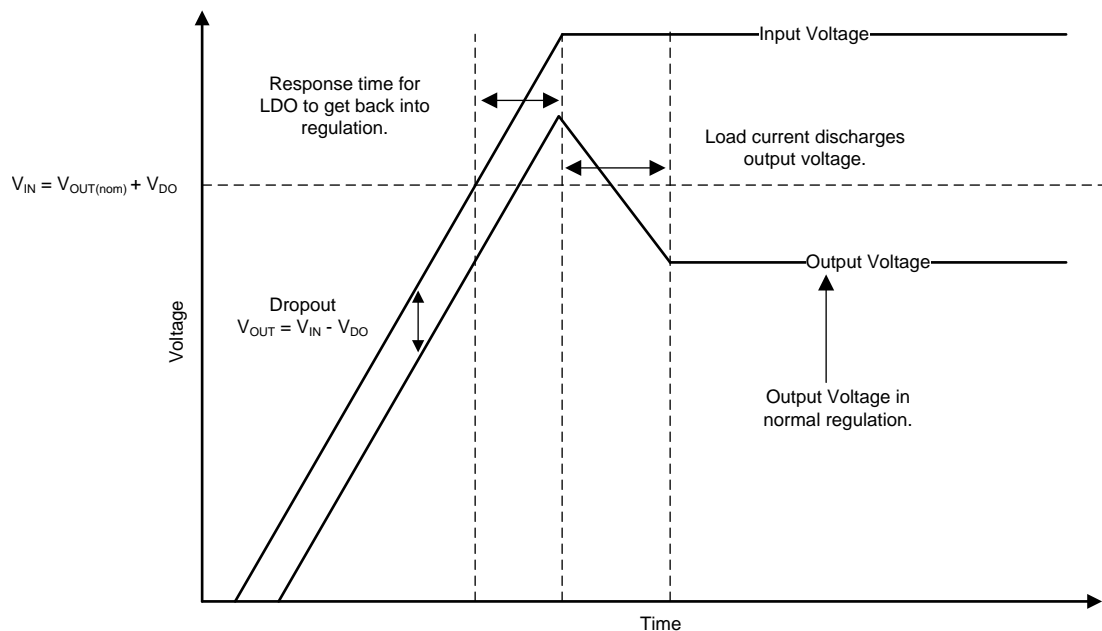
Application Information (接下页)

图 28. Startup into Dropout

Line transients out of dropout can also cause overshoot on the output of the regulator. These overshoots are caused by the error amplifier having to drive the gate capacitance of the pass element and bring the gate back to the correct voltage for proper regulation. 图 29 illustrates what is happening internally with the gate voltage and how overshoot can be caused during operation. When the LDO is placed in dropout, the gate voltage (VGS) is pulled all the way down to give the pass device the lowest on-resistance as possible. However, if a line transient occurs while the device is in dropout, the loop is not in regulation which can cause the output to overshoot until the loop responds and the output current pulls the output voltage back down into regulation. If these transients are not acceptable, then continue to add input capacitance in the system until the transient is slow enough to reduce the overshoot.

Application Information (接下页)



图 29. Line Transients From Dropout

8.1.4 Reverse Current

As with most LDOs, excessive reverse current can damage this device.

Reverse current flows through the body diode on the pass element instead of the normal conducting channel. At high magnitudes, this current flow degrades the long-term reliability of the device, as a result of one of the following conditions:

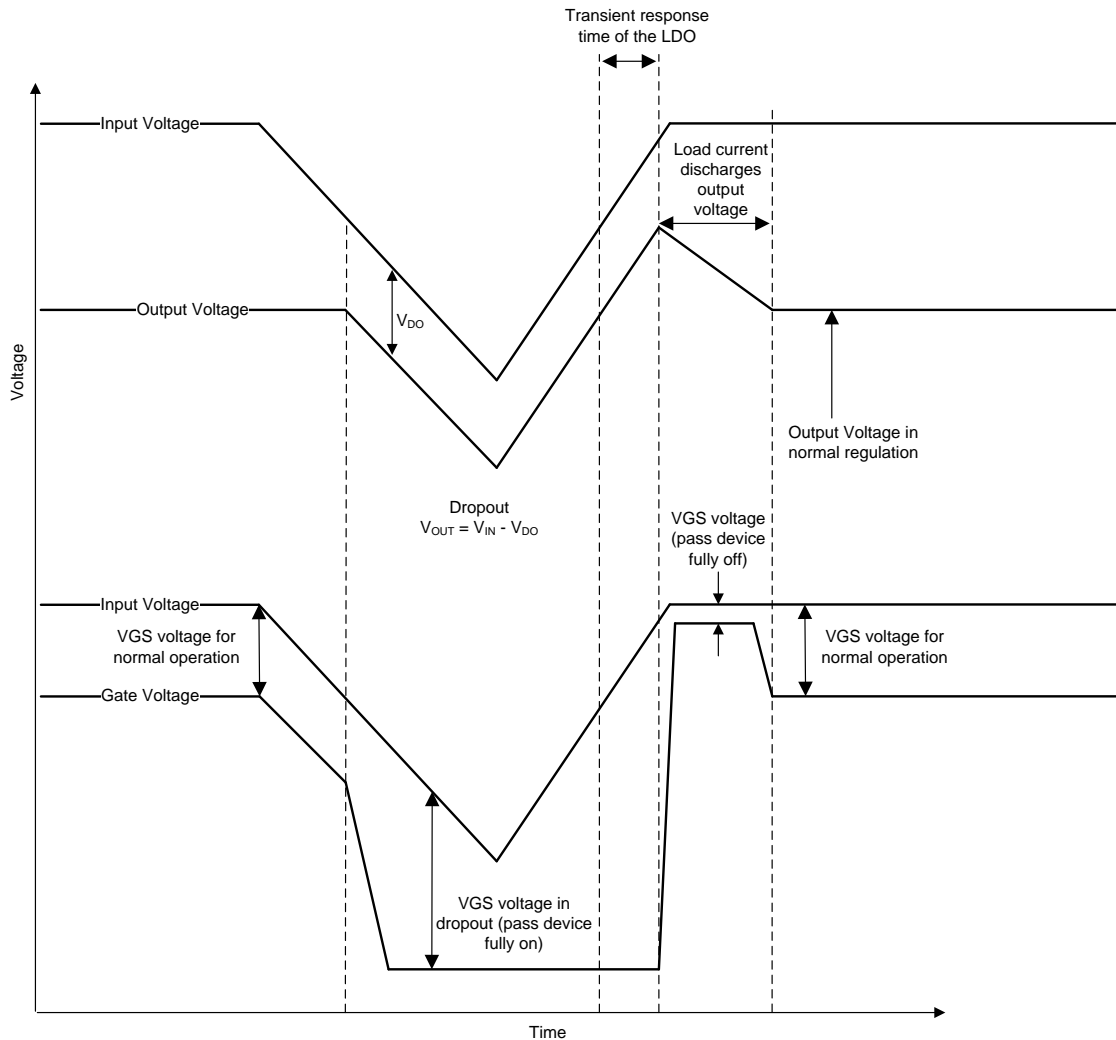
- Degradation caused by electromigration
- Excessive heat dissipation
- Potential for a latch-up condition

Conditions where reverse current can occur are outlined in this section, all of which can exceed the absolute maximum rating of $V_{OUT} > V_{IN} + 0.3\text{ V}$:

- If the device has a large C_{OUT} and the input supply collapses with little or no load current
- The output is biased when the input supply is not established
- The output is biased above the input supply

Application Information (接下页)

If reverse current flow is expected in the application, external protection must be used to protect the device. 图 30 shows one approach of protecting the device.



图 30. Example Circuit for Reverse Current Protection Using a Schottky Diode

8.1.5 Power Dissipation (P_D)

Circuit reliability demands that proper consideration is given to device power dissipation, location of the circuit on the printed circuit board (PCB), and correct sizing of the thermal plane. The PCB area around the regulator must be as free of other heat-generating devices as possible that cause added thermal stresses.

As a first-order approximation, power dissipation in the regulator depends on the input-to-output voltage difference and load conditions. Use 公式 2 to approximate P_D :

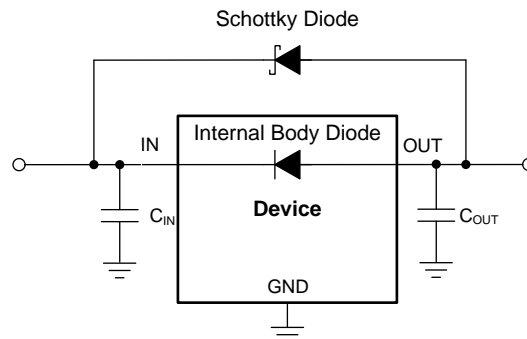
$$P_D = (V_{IN} - V_{OUT}) \times I_{OUT} \quad (2)$$

It is important to minimize power dissipation to achieve greater efficiency. This minimizing process is achieved by selecting the correct system voltage rails. Proper selection helps obtain the minimum input-to-output voltage differential. The low dropout of the device allows for maximum efficiency across a wide range of output voltages.

The main heat conduction path for the device is through the thermal pad on the package. As such, the thermal pad must be soldered to a copper pad area under the device. This pad area should contain an array of plated vias that conduct heat to inner plane areas or to a bottom-side copper plane.

The maximum allowable junction temperature (T_J) determines the maximum power dissipation for the device. Power dissipation and junction temperature are most often related by the junction-to-ambient thermal resistance (θ_{JA}) of the combined PCB, device package, and the temperature of the ambient air (T_A), according to 公式 3.

$$T_J = T_A + \theta_{JA} \times P_D \quad (3)$$

Unfortunately, this thermal resistance (θ_{JA}) is dependent on the heat-spreading capability built into the particular PCB design, and therefore varies according to the total copper area, copper weight, and location of the planes. The θ_{JA} value is only used as a relative measure of package thermal performance. θ_{JA} is the sum of the VQFN package junction-to-case (bottom) thermal resistance (θ_{JCBot}) plus the thermal resistance contribution by the PCB copper.

Application Information (接下页)

8.1.5.1 Estimating Junction Temperature

The JEDEC standard recommends the use of psi (Ψ) thermal metrics to estimate the junction temperatures of the LDO when in-circuit on a typical PCB board application. These metrics are not thermal resistances, but offer practical and relative means of estimating junction temperatures. These psi metrics are independent of the copper-spreading area. The key thermal metrics (Ψ_{JT} and Ψ_{JB}) are shown in the table and are used in accordance with [公式 4](#).

$$\Psi_{JT}: T_J = T_T + \Psi_{JT} \times P_D$$

$$\Psi_{JB}: T_J = T_B + \Psi_{JB} \times P_D$$

where:

- P_D is the power dissipated as shown in [公式 2](#)
- T_T is the temperature at the center-top of the device package, and
- T_B is the PCB surface temperature measured 1 mm from the device package and centered on the package edge

(4)

8.2 Typical Application



图 31. TLV757P Typical Application

8.2.1 Design Requirements

[表 2](#) lists the design requirements for this application.

表 2. Design Parameters

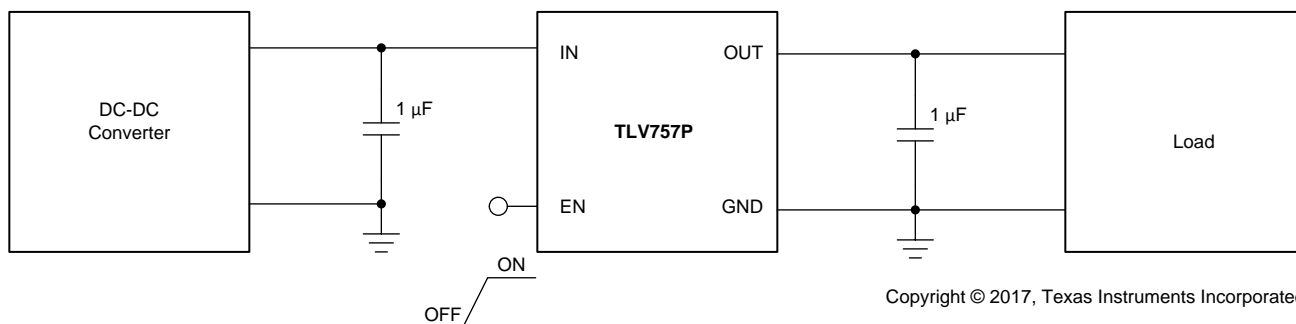
PARAMETER	DESIGN REQUIREMENT
Input voltage	2.5 V
Output voltage	1.8 V
Input current	700 mA (maximum)
Output load	600-mA DC
Maximum ambient temperature	70°C

8.2.2 Detailed Design Procedure

8.2.2.1 Input Current

During normal operation, the input current to the LDO is approximately equal to the output current of the LDO. During startup, the input current is higher as a result of the inrush current charging the output capacitor. Use 公式 5 to calculate the current through the input.

$$I_{OUT(t)} = \left(\frac{C_{OUT} \times dV_{OUT}(t)}{dt} \right) + \left(\frac{V_{OUT}(t)}{R_{LOAD}} \right)$$

where:

- $V_{OUT}(t)$ is the instantaneous output voltage of the turn-on ramp
 - $dV_{OUT}(t) / dt$ is the slope of the V_{OUT} ramp
 - R_{LOAD} is the resistive load impedance
- (5)

8.2.2.2 Thermal Dissipation

The junction temperature can be determined using the junction-to-ambient thermal resistance ($R_{\theta JA}$) and the total power dissipation (P_D). Use 公式 6 to calculate the power dissipation. Multiply P_D by $R_{\theta JA}$ and add the ambient temperature (T_A) to calculate the junction temperature (T_J) as 公式 7 shows.

$$P_D = (I_{GND} + I_{OUT}) \times (V_{IN} - V_{OUT}) \tag{6}$$

$$T_J = R_{\theta JA} \times P_D + T_A \tag{7}$$

If the ($T_{J(MAX)}$) value does not exceed 125°C calculate the maximum ambient temperature as 公式 8 shows. 公式 9 calculates the maximum ambient temperature with a value of 82.916°C .

$$T_{A(MAX)} = T_{J(MAX)} - R_{\theta JA} \times P_D \tag{8}$$

$$T_{A(MAX)} = 125^\circ\text{C} - 100.2 \times (2.5\text{ V} - 1.8\text{ V}) \times (0.6\text{ A}) = 82.916^\circ\text{C} \tag{9}$$

8.2.3 Application Curves

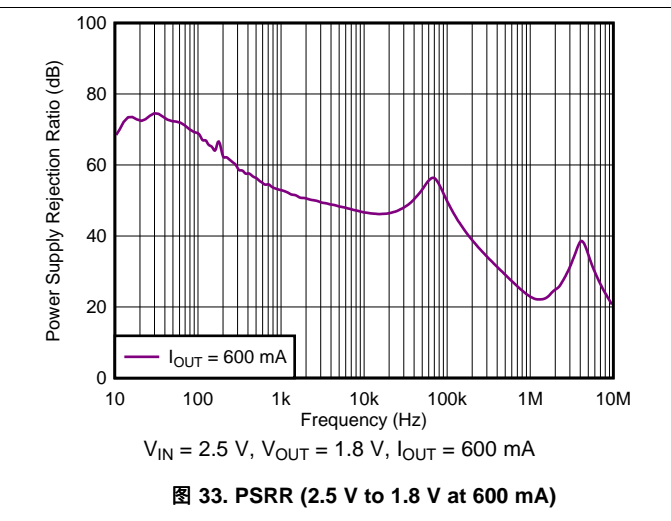
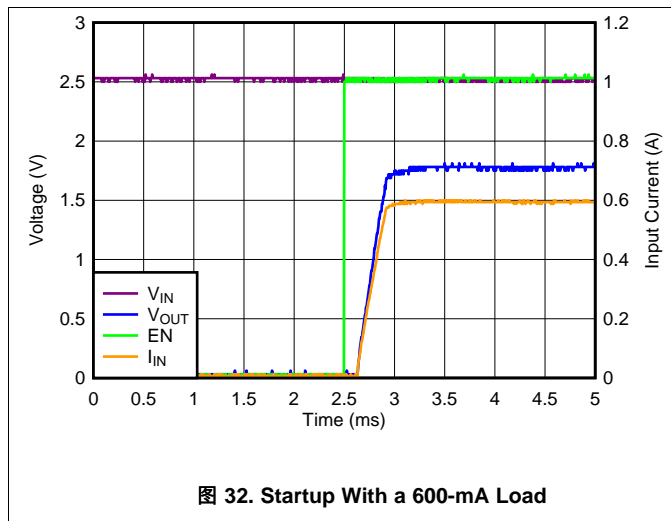

9 Power Supply Recommendations

Connect a low output impedance power supply directly to the IN pin of the TLV757P. If the input source is reactive, consider using multiple input capacitors in parallel with the 1- μF input capacitor to lower the input supply impedance over frequency.

10 Layout

10.1 Layout Guidelines

- Place input and output capacitors as close as possible to the device.
- Use copper planes for device connections to optimize thermal performance.
- Place thermal vias around the device to distribute the heat.

10.2 Layout Examples

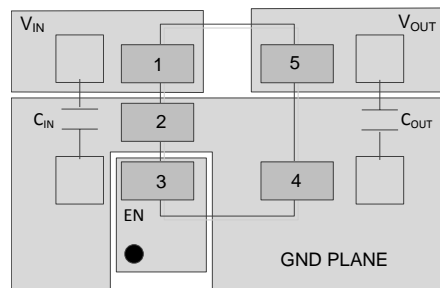

● Represents via used for application specific connections

图 34. Layout Example: DBV Package

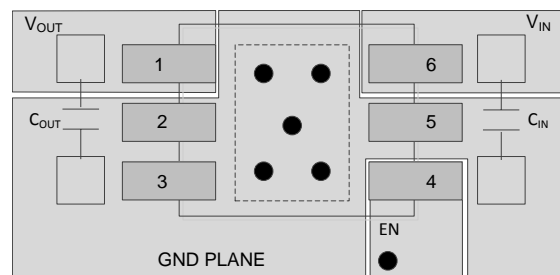

● Represents via used for application specific connections

图 35. Layout Example: DRV Package

11 器件和文档支持

11.1 器件支持

11.1.1 器件命名规则

表 3. 器件命名规则⁽¹⁾⁽²⁾

产品	V _{OUT}
TLV757xx(x)Pyyyz	<p>xx(x) 为标称输出电压。对于分辨率为 50mV 的输出电压，订货编号中使用两位数字；否则，使用三位数字（例如，28 = 2.8V；125 = 1.25 V）。</p> <p>P 表示有源输出放电功能。TLV757P 系列的所有产品在器件处于禁用状态时都可以对输出进行主动放电。</p> <p>yyy 为封装标识符。</p> <p>z 为封装数量。R 表示卷（3000 片），T 表示带（250 片）。</p>

- (1) 要获得最新的封装和订货信息，请参见本文档末尾的封装选项附录，或者访问器件产品文件夹（www.ti.com.cn）。
- (2) 可提供 0.6V 至 5V 范围内的输出电压（以 50mV 为单位增加）。有关器件的详细信息和供货情况，请联系制造商。

11.2 接收文档更新通知

要接收文档更新通知，请导航至 TI.com 上的器件产品文件夹。单击右上角的 **通知我** 进行注册，即可每周接收产品信息更改摘要。有关更改的详细信息，请查看任何已修订文档中包含的修订历史记录。

11.3 社区资源

下列链接提供到 TI 社区资源的连接。链接的内容由各个分销商“按照原样”提供。这些内容并不构成 TI 技术规范，并且不一定反映 TI 的观点；请参阅 TI 的《使用条款》。

TI E2E™ 在线社区 *TI 的工程师对工程师 (E2E) 社区*。此社区的创建目的在于促进工程师之间的协作。在 e2e.ti.com 中，您可以咨询问题、分享知识、拓展思路并与同行工程师一道帮助解决问题。

设计支持 *TI 参考设计支持* 可帮助您快速查找有帮助的 E2E 论坛、设计支持工具以及技术支持的联系信息。

11.4 商标

E2E is a trademark of Texas Instruments.
All other trademarks are the property of their respective owners.

11.5 静电放电警告



ESD 可能会损坏该集成电路。德州仪器 (TI) 建议通过适当的预防措施处理所有集成电路。如果不遵守正确的处理措施和安装程序，可能会损坏集成电路。

ESD 的损坏小至导致微小的性能降级，大至整个器件故障。精密的集成电路可能更容易受到损坏，这是因为非常细微的参数更改都可能会导致器件与其发布的规格不相符。

11.6 Glossary

SLYZ022 — *TI Glossary*.

This glossary lists and explains terms, acronyms, and definitions.

12 机械、封装和可订购信息

以下页面包含机械、封装和可订购信息。这些信息是指定器件的最新可用数据。数据如有变更，恕不另行通知和修订此文档。如欲获取此产品说明书的浏览器版本，请参阅左侧的导航。

PACKAGING INFORMATION

Orderable Device	Status (1)	Package Type	Package Drawing	Pins	Package Qty	Eco Plan (2)	Lead finish/ Ball material (6)	MSL Peak Temp (3)	Op Temp (°C)	Device Marking (4/5)	Samples
TLV75709PDBVR	ACTIVE	SOT-23	DBV	5	3000	RoHS & Green	NIPDAU SN	Level-1-260C-UNLIM	-40 to 125	1H8F	Samples
TLV75709PDRVR	ACTIVE	WSON	DRV	6	3000	RoHS & Green	NIPDAU	Level-1-260C-UNLIM	-40 to 125	1HGH	Samples
TLV75710PDBVR	ACTIVE	SOT-23	DBV	5	3000	RoHS & Green	NIPDAU SN	Level-1-260C-UNLIM	-40 to 125	1FEF	Samples
TLV75710PDRVR	ACTIVE	WSON	DRV	6	3000	RoHS & Green	NIPDAU	Level-1-260C-UNLIM	-40 to 125	1HHH	Samples
TLV75712PDBVR	ACTIVE	SOT-23	DBV	5	3000	RoHS & Green	NIPDAU SN	Level-1-260C-UNLIM	-40 to 125	1FFF	Samples
TLV75712PDRVR	ACTIVE	WSON	DRV	6	3000	RoHS & Green	NIPDAU	Level-1-260C-UNLIM	-40 to 125	1HIH	Samples
TLV75715PDBVR	ACTIVE	SOT-23	DBV	5	3000	RoHS & Green	NIPDAU SN	Level-1-260C-UNLIM	-40 to 125	1FGF	Samples
TLV75715PDRVR	ACTIVE	WSON	DRV	6	3000	RoHS & Green	NIPDAU	Level-1-260C-UNLIM	-40 to 125	1HJH	Samples
TLV75718PDBVR	ACTIVE	SOT-23	DBV	5	3000	RoHS & Green	NIPDAU SN	Level-1-260C-UNLIM	-40 to 125	1FHF	Samples
TLV75718PDRVR	ACTIVE	WSON	DRV	6	3000	RoHS & Green	NIPDAU	Level-1-260C-UNLIM	-40 to 125	1HKH	Samples
TLV75719PDBVR	ACTIVE	SOT-23	DBV	5	3000	RoHS & Green	NIPDAU SN	Level-1-260C-UNLIM	-40 to 125	1H7F	Samples
TLV75719PDRVR	ACTIVE	WSON	DRV	6	3000	RoHS & Green	NIPDAU	Level-1-260C-UNLIM	-40 to 125	1HLH	Samples
TLV75725PDBVR	ACTIVE	SOT-23	DBV	5	3000	RoHS & Green	NIPDAU SN	Level-1-260C-UNLIM	-40 to 125	1FIF	Samples
TLV75725PDRVR	ACTIVE	WSON	DRV	6	3000	RoHS & Green	NIPDAU	Level-1-260C-UNLIM	-40 to 125	1HMH	Samples
TLV75728PDBVR	ACTIVE	SOT-23	DBV	5	3000	RoHS & Green	NIPDAU SN	Level-1-260C-UNLIM	-40 to 125	1FJF	Samples
TLV75728PDRVR	ACTIVE	WSON	DRV	6	3000	RoHS & Green	NIPDAU	Level-1-260C-UNLIM	-40 to 125	1HNH	Samples
TLV75729PDBVR	ACTIVE	SOT-23	DBV	5	3000	RoHS & Green	NIPDAU SN	Level-1-260C-UNLIM	-40 to 125	1H9F	Samples
TLV75730PDBVR	ACTIVE	SOT-23	DBV	5	3000	RoHS & Green	NIPDAU SN	Level-1-260C-UNLIM	-40 to 125	1GHF	Samples
TLV75730PDRVR	ACTIVE	WSON	DRV	6	3000	RoHS & Green	NIPDAU	Level-1-260C-UNLIM	-40 to 125	1HOH	Samples
TLV75733PDBVR	ACTIVE	SOT-23	DBV	5	3000	RoHS & Green	NIPDAU SN	Level-1-260C-UNLIM	-40 to 125	1FKF	Samples

Orderable Device	Status (1)	Package Type	Package Drawing	Pins	Package Qty	Eco Plan (2)	Lead finish/ Ball material (6)	MSL Peak Temp (3)	Op Temp (°C)	Device Marking (4/5)	Samples
TLV75733PDRVR	ACTIVE	WSON	DRV	6	3000	RoHS & Green	NIPDAU	Level-1-260C-UNLIM	-40 to 125	1HPH	Samples
TLV75740PDRVR	ACTIVE	WSON	DRV	6	3000	RoHS & Green	NIPDAU	Level-1-260C-UNLIM	-40 to 125	1HQH	Samples

(1) The marketing status values are defined as follows:

ACTIVE: Product device recommended for new designs.

LIFEBUY: TI has announced that the device will be discontinued, and a lifetime-buy period is in effect.

NRND: Not recommended for new designs. Device is in production to support existing customers, but TI does not recommend using this part in a new design.

PREVIEW: Device has been announced but is not in production. Samples may or may not be available.

OBSOLETE: TI has discontinued the production of the device.

(2) **RoHS:** TI defines "RoHS" to mean semiconductor products that are compliant with the current EU RoHS requirements for all 10 RoHS substances, including the requirement that RoHS substance do not exceed 0.1% by weight in homogeneous materials. Where designed to be soldered at high temperatures, "RoHS" products are suitable for use in specified lead-free processes. TI may reference these types of products as "Pb-Free".

RoHS Exempt: TI defines "RoHS Exempt" to mean products that contain lead but are compliant with EU RoHS pursuant to a specific EU RoHS exemption.

Green: TI defines "Green" to mean the content of Chlorine (Cl) and Bromine (Br) based flame retardants meet JS709B low halogen requirements of <=1000ppm threshold. Antimony trioxide based flame retardants must also meet the <=1000ppm threshold requirement.

(3) MSL, Peak Temp. - The Moisture Sensitivity Level rating according to the JEDEC industry standard classifications, and peak solder temperature.

(4) There may be additional marking, which relates to the logo, the lot trace code information, or the environmental category on the device.

(5) Multiple Device Markings will be inside parentheses. Only one Device Marking contained in parentheses and separated by a "~" will appear on a device. If a line is indented then it is a continuation of the previous line and the two combined represent the entire Device Marking for that device.

(6) Lead finish/Ball material - Orderable Devices may have multiple material finish options. Finish options are separated by a vertical ruled line. Lead finish/Ball material values may wrap to two lines if the finish value exceeds the maximum column width.

Important Information and Disclaimer:The information provided on this page represents TI's knowledge and belief as of the date that it is provided. TI bases its knowledge and belief on information provided by third parties, and makes no representation or warranty as to the accuracy of such information. Efforts are underway to better integrate information from third parties. TI has taken and continues to take reasonable steps to provide representative and accurate information but may not have conducted destructive testing or chemical analysis on incoming materials and chemicals. TI and TI suppliers consider certain information to be proprietary, and thus CAS numbers and other limited information may not be available for release.

In no event shall TI's liability arising out of such information exceed the total purchase price of the TI part(s) at issue in this document sold by TI to Customer on an annual basis.

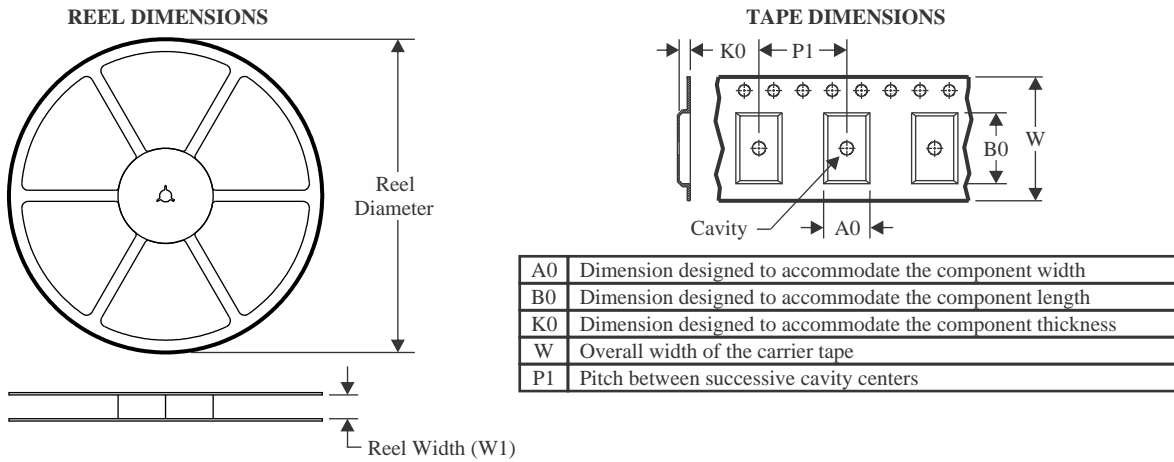
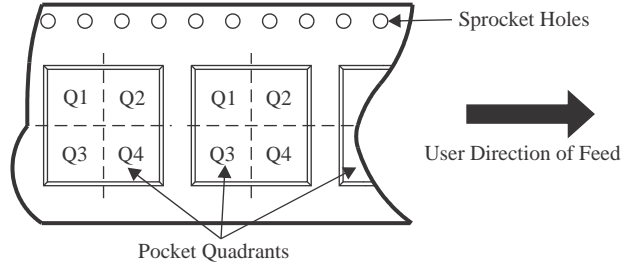
TAPE AND REEL INFORMATION

QUADRANT ASSIGNMENTS FOR PIN 1 ORIENTATION IN TAPE

*All dimensions are nominal

Device	Package Type	Package Drawing	Pins	SPQ	Reel Diameter (mm)	Reel Width W1 (mm)	A0 (mm)	B0 (mm)	K0 (mm)	P1 (mm)	W (mm)	Pin1 Quadrant
TLV75709PDBVR	SOT-23	DBV	5	3000	180.0	8.4	3.2	3.2	1.4	4.0	8.0	Q3
TLV75709PDBVR	SOT-23	DBV	5	3000	180.0	8.4	3.2	3.2	1.4	4.0	8.0	Q3
TLV75709PDRVR	WSO	DRV	6	3000	180.0	8.4	2.3	2.3	1.15	4.0	8.0	Q2
TLV75710PDBVR	SOT-23	DBV	5	3000	180.0	8.4	3.2	3.2	1.4	4.0	8.0	Q3
TLV75710PDBVR	SOT-23	DBV	5	3000	180.0	8.4	3.2	3.2	1.4	4.0	8.0	Q3
TLV75710PDRVR	WSO	DRV	6	3000	180.0	8.4	2.3	2.3	1.15	4.0	8.0	Q2
TLV75712PDBVR	SOT-23	DBV	5	3000	180.0	8.4	3.2	3.2	1.4	4.0	8.0	Q3
TLV75712PDBVR	SOT-23	DBV	5	3000	180.0	8.4	3.2	3.2	1.4	4.0	8.0	Q3
TLV75712PDRVR	WSO	DRV	6	3000	180.0	8.4	2.3	2.3	1.15	4.0	8.0	Q2
TLV75715PDBVR	SOT-23	DBV	5	3000	180.0	8.4	3.2	3.2	1.4	4.0	8.0	Q3
TLV75715PDBVR	SOT-23	DBV	5	3000	180.0	8.4	3.2	3.2	1.4	4.0	8.0	Q3
TLV75715PDRVR	WSO	DRV	6	3000	180.0	8.4	2.3	2.3	1.15	4.0	8.0	Q2
TLV75718PDBVR	SOT-23	DBV	5	3000	180.0	8.4	3.2	3.2	1.4	4.0	8.0	Q3
TLV75718PDBVR	SOT-23	DBV	5	3000	180.0	8.4	3.2	3.2	1.4	4.0	8.0	Q3
TLV75718PDRVR	WSO	DRV	6	3000	180.0	8.4	2.3	2.3	1.15	4.0	8.0	Q2
TLV75719PDBVR	SOT-23	DBV	5	3000	180.0	8.4	3.2	3.2	1.4	4.0	8.0	Q3

Device	Package Type	Package Drawing	Pins	SPQ	Reel Diameter (mm)	Reel Width W1 (mm)	A0 (mm)	B0 (mm)	K0 (mm)	P1 (mm)	W (mm)	Pin1 Quadrant
TLV75719PDBVR	SOT-23	DBV	5	3000	180.0	8.4	3.2	3.2	1.4	4.0	8.0	Q3
TLV75719PDRVR	WSON	DRV	6	3000	180.0	8.4	2.3	2.3	1.15	4.0	8.0	Q2
TLV75725PDBVR	SOT-23	DBV	5	3000	180.0	8.4	3.2	3.2	1.4	4.0	8.0	Q3
TLV75725PDBVR	SOT-23	DBV	5	3000	180.0	8.4	3.2	3.2	1.4	4.0	8.0	Q3
TLV75725PDRVR	WSON	DRV	6	3000	180.0	8.4	2.3	2.3	1.15	4.0	8.0	Q2
TLV75728PDBVR	SOT-23	DBV	5	3000	180.0	8.4	3.2	3.2	1.4	4.0	8.0	Q3
TLV75728PDBVR	SOT-23	DBV	5	3000	180.0	8.4	3.2	3.2	1.4	4.0	8.0	Q3
TLV75728PDRVR	WSON	DRV	6	3000	180.0	8.4	2.3	2.3	1.15	4.0	8.0	Q2
TLV75729PDBVR	SOT-23	DBV	5	3000	180.0	8.4	3.2	3.2	1.4	4.0	8.0	Q3
TLV75729PDBVR	SOT-23	DBV	5	3000	180.0	8.4	3.2	3.2	1.4	4.0	8.0	Q3
TLV75730PDBVR	SOT-23	DBV	5	3000	180.0	8.4	3.2	3.2	1.4	4.0	8.0	Q3
TLV75730PDBVR	SOT-23	DBV	5	3000	180.0	8.4	3.2	3.2	1.4	4.0	8.0	Q3
TLV75730PDRVR	WSON	DRV	6	3000	180.0	8.4	2.3	2.3	1.15	4.0	8.0	Q2
TLV75733PDBVR	SOT-23	DBV	5	3000	178.0	9.0	3.3	3.2	1.4	4.0	8.0	Q3
TLV75733PDBVR	SOT-23	DBV	5	3000	180.0	8.4	3.2	3.2	1.4	4.0	8.0	Q3
TLV75733PDRVR	WSON	DRV	6	3000	180.0	8.4	2.3	2.3	1.15	4.0	8.0	Q2
TLV75740PDRVR	WSON	DRV	6	3000	180.0	8.4	2.3	2.3	1.15	4.0	8.0	Q2

TAPE AND REEL BOX DIMENSIONS

*All dimensions are nominal

Device	Package Type	Package Drawing	Pins	SPQ	Length (mm)	Width (mm)	Height (mm)
TLV75709PDBVR	SOT-23	DBV	5	3000	210.0	185.0	35.0
TLV75709PDBVR	SOT-23	DBV	5	3000	210.0	185.0	35.0
TLV75709PDRVR	WSON	DRV	6	3000	210.0	185.0	35.0
TLV75710PDBVR	SOT-23	DBV	5	3000	210.0	185.0	35.0
TLV75710PDBVR	SOT-23	DBV	5	3000	210.0	185.0	35.0
TLV75710PDRVR	WSON	DRV	6	3000	210.0	185.0	35.0
TLV75712PDBVR	SOT-23	DBV	5	3000	210.0	185.0	35.0
TLV75712PDBVR	SOT-23	DBV	5	3000	210.0	185.0	35.0
TLV75712PDRVR	WSON	DRV	6	3000	210.0	185.0	35.0
TLV75715PDBVR	SOT-23	DBV	5	3000	210.0	185.0	35.0
TLV75715PDBVR	SOT-23	DBV	5	3000	210.0	185.0	35.0
TLV75715PDRVR	WSON	DRV	6	3000	210.0	185.0	35.0
TLV75718PDBVR	SOT-23	DBV	5	3000	210.0	185.0	35.0
TLV75718PDBVR	SOT-23	DBV	5	3000	210.0	185.0	35.0
TLV75718PDRVR	WSON	DRV	6	3000	210.0	185.0	35.0
TLV75719PDBVR	SOT-23	DBV	5	3000	210.0	185.0	35.0
TLV75719PDBVR	SOT-23	DBV	5	3000	210.0	185.0	35.0
TLV75719PDRVR	WSON	DRV	6	3000	210.0	185.0	35.0

Device	Package Type	Package Drawing	Pins	SPQ	Length (mm)	Width (mm)	Height (mm)
TLV75725PDBVR	SOT-23	DBV	5	3000	210.0	185.0	35.0
TLV75725PDBVR	SOT-23	DBV	5	3000	210.0	185.0	35.0
TLV75725PDRVR	WSON	DRV	6	3000	210.0	185.0	35.0
TLV75728PDBVR	SOT-23	DBV	5	3000	210.0	185.0	35.0
TLV75728PDBVR	SOT-23	DBV	5	3000	210.0	185.0	35.0
TLV75728PDRVR	WSON	DRV	6	3000	210.0	185.0	35.0
TLV75729PDBVR	SOT-23	DBV	5	3000	210.0	185.0	35.0
TLV75729PDBVR	SOT-23	DBV	5	3000	210.0	185.0	35.0
TLV75730PDBVR	SOT-23	DBV	5	3000	210.0	185.0	35.0
TLV75730PDBVR	SOT-23	DBV	5	3000	210.0	185.0	35.0
TLV75730PDRVR	WSON	DRV	6	3000	210.0	185.0	35.0
TLV75733PDBVR	SOT-23	DBV	5	3000	180.0	180.0	18.0
TLV75733PDBVR	SOT-23	DBV	5	3000	210.0	185.0	35.0
TLV75733PDRVR	WSON	DRV	6	3000	210.0	185.0	35.0
TLV75740PDRVR	WSON	DRV	6	3000	210.0	185.0	35.0

GENERIC PACKAGE VIEW

DRV 6

WSON - 0.8 mm max height

PLASTIC SMALL OUTLINE - NO LEAD



Images above are just a representation of the package family, actual package may vary.
Refer to the product data sheet for package details.

4206925/F



4222173/B 04/2018

NOTES:

1. All linear dimensions are in millimeters. Any dimensions in parenthesis are for reference only. Dimensioning and tolerancing per ASME Y14.5M.
2. This drawing is subject to change without notice.
3. The package thermal pad must be soldered to the printed circuit board for thermal and mechanical performance.

EXAMPLE STENCIL DESIGN

DRV0006A

WSON - 0.8 mm max height

PLASTIC SMALL OUTLINE - NO LEAD



SOLDER PASTE EXAMPLE
BASED ON 0.125 mm THICK STENCIL

EXPOSED PAD #7
88% PRINTED SOLDER COVERAGE BY AREA UNDER PACKAGE
SCALE:30X

4222173/B 04/2018

NOTES: (continued)

6. Laser cutting apertures with trapezoidal walls and rounded corners may offer better paste release. IPC-7525 may have alternate design recommendations.

EXAMPLE BOARD LAYOUT

DBV0005A

SOT-23 - 1.45 mm max height

SMALL OUTLINE TRANSISTOR



LAND PATTERN EXAMPLE
EXPOSED METAL SHOWN
SCALE:15X



SOLDER MASK DETAILS

4214839/F 06/2021

NOTES: (continued)

- 5. Publication IPC-7351 may have alternate designs.
- 6. Solder mask tolerances between and around signal pads can vary based on board fabrication site.

EXAMPLE STENCIL DESIGN

DBV0005A

SOT-23 - 1.45 mm max height

SMALL OUTLINE TRANSISTOR



SOLDER PASTE EXAMPLE
BASED ON 0.125 mm THICK STENCIL
SCALE:15X

4214839/F 06/2021

NOTES: (continued)

7. Laser cutting apertures with trapezoidal walls and rounded corners may offer better paste release. IPC-7525 may have alternate design recommendations.
8. Board assembly site may have different recommendations for stencil design.

重要声明和免责声明

TI“按原样”提供技术和可靠性数据（包括数据表）、设计资源（包括参考设计）、应用或其他设计建议、网络工具、安全信息和其他资源，不保证没有瑕疵且不做任何明示或暗示的担保，包括但不限于对适销性、某特定用途方面的适用性或不侵犯任何第三方知识产权的暗示担保。

这些资源可供使用 TI 产品进行设计的熟练开发人员使用。您将自行承担以下全部责任：(1) 针对您的应用选择合适的 TI 产品，(2) 设计、验证并测试您的应用，(3) 确保您的应用满足相应标准以及任何其他功能安全、信息安全、监管或其他要求。

这些资源如有变更，恕不另行通知。TI 授权您仅可将这些资源用于研发本资源所述的 TI 产品的应用。严禁对这些资源进行其他复制或展示。您无权使用任何其他 TI 知识产权或任何第三方知识产权。您应全额赔偿因在这些资源的使用中对 TI 及其代表造成的任何索赔、损害、成本、损失和债务，TI 对此概不负责。

TI 提供的产品受 [TI 的销售条款](#) 或 [ti.com](#) 上其他适用条款/TI 产品随附的其他适用条款的约束。TI 提供这些资源并不会扩展或以其他方式更改 TI 针对 TI 产品发布的适用的担保或担保免责声明。

TI 反对并拒绝您可能提出的任何其他或不同的条款。

邮寄地址：Texas Instruments, Post Office Box 655303, Dallas, Texas 75265

Copyright © 2023，德州仪器 (TI) 公司

X-ON Electronics

Largest Supplier of Electrical and Electronic Components

Click to view similar products for [LDO Voltage Regulators](#) category:

Click to view products by [Texas Instruments](#) manufacturer:

Other Similar products are found below :

[AP7363-SP-13](#) [NCV8664CST33T3G](#) [L79M05TL-E](#) [AP7362-HA-7](#) [PT7M8202B12TA5EX](#) [TCR3DF185,LM\(CT](#) [TLF4949EJ](#)
[NCP4687DH15T1G](#) [NCV8703MX30TCG](#) [LP2951CN](#) [NCV4269CPD50R2G](#) [AP7315-25W5-7](#) [NCV47411PAAJR2G](#) [AP2111H-1.2TRG1](#)
[ZLDO1117QK50TC](#) [AZ1117ID-ADJTRG1](#) [NCV4263-2CPD50R2G](#) [NCP114BMX075TCG](#) [MC33269T-3.5G](#) [TLE4471GXT](#) [AP7315-33SA-](#)
[7](#) [NCV4266-2CST33T3G](#) [NCP715SQ15T2G](#) [NCV8623MN-50R2G](#) [NCV563SQ18T1G](#) [NCV8664CDT33RKG](#) [NCV4299CD250R2G](#)
[NCP715MX30TBG](#) [NCV8702MX25TCG](#) [TLE7270-2E](#) [NCV562SQ25T1G](#) [AP2213D-3.3TRG1](#) [AP2202K-2.6TRE1](#)
[NCV8170BMX300TCG](#) [NCV8152MX300180TCG](#) [NCP700CMT45TBG](#) [AP7315-33W5-7](#) [NCP154MX180300TAG](#) [AP2113AMTR-G1](#)
[NJV4104U2-33A-TE1](#) [MP2013AGG-5-P](#) [NCV8775CDT50RKG](#) [NJM2878F3-45-TE1](#) [S-19214B00A-V5T2U7](#) [S-19214B50A-V5T2U7](#) [S-](#)
[19213B50A-V5T2U7](#) [S-19214BC0A-E8T1U7*1](#) [S-19213B00A-V5T2U7](#) [S-19213B33A-V5T2U7](#) [S-19213BC0A-V5T2U7](#)