

# TLV803E、TLV809E、TLV810E 低功耗 250nA I<sub>Q</sub> 和小尺寸电源电压监控器

## 1 特性

- 当 VDD = 0.7-6V 时，确保执行  $\overline{\text{RESET}}/\text{RESET}$
- 固定延时时间：40 $\mu\text{s}$ 、10ms、50ms、100ms、200ms、400ms
- 电源电流 (IDD)：250nA (典型值)
  - 1 $\mu\text{A}$  (VDD = 3.3V 时的最大值)
- 输出拓扑：
  - TLV809E：推挽，低电平有效
  - TLV803E：开漏，低电平有效
  - TLV810E：推挽，高电平有效
- 欠压检测：
  - 高准确度： $\pm 0.5\%$  (典型值)
  - (V<sub>IT-</sub>)：1.7V、1.8V、1.9V、2.25V、2.4V、2.64V、2.93V、3.08V、3.3V、4.2V、4.38V、4.55V、4.63V
- 封装：
  - SOT23-3 (DBZ) (引脚 1 = GND)
  - SOT23-3 (DBZ) (带引脚 1 =  $\overline{\text{RESET}}/\text{RESET}$ )
  - SOT23-3 (DBZ) (引脚 3 = GND)
  - SC-70 (DCK)
  - X2SON-5 (DPW)
- 温度范围：-40°C 至 +125°C
- 与 MAX803/809/810、APX803/809/810 引脚对引脚兼容

## 2 应用

- 电表
- 工厂自动化
- 便携式、电池供电类设备
- 机顶盒和电视
- 楼宇自动化
- 笔记本电脑/台式机、服务器

## 3 说明

TLV803E、TLV809E 和 TLV810E 是 TLV803、TLV853、TLV809、LM809、TPS3809 和 TLV810 的增强替代品。TLV80xE 和 TLV81xE 具有静态电流 I<sub>Q</sub> 低、精度高、温度范围宽和上电复位 (V<sub>POR</sub>) 低等优势，能够提高系统可靠性。

TLV80xE 和 TLV81xE 系列是具有低 I<sub>Q</sub> (250nA 典型值、1 $\mu\text{A}$  最大值) 的电压监控电路 (复位 IC)，可监控 VDD 电压电平。每当电源电压 VDD 下降到出厂编程下降阈值电压 V<sub>IT-</sub> 以下时，这些器件都会启动一个复位信号。VDD 电压升至上升电压阈值 (V<sub>IT+</sub>) (等于下降电压阈值 (V<sub>IT-</sub>) 与迟滞电压

(V<sub>HYS</sub>) 之和) 以上后，在固定复位延时时间 t<sub>D</sub> 内，复位输出都会保持低电平。

这些器件具有集成的毛刺抑制功能，可忽略 VDD 引脚上的快速瞬变。这些电压监控器的 I<sub>Q</sub> 低，且精度高 (典型值为  $\pm 0.5\%$ )，非常适合低功耗和便携式应用。对于低至 V<sub>POR</sub> = 0.7V 的电源电压，TLV80xE 和 TLV81xE 器件具有指定输出逻辑状态。TLV80xE 和 TLV81xE 器件可采用业界通用的 3 引脚 SOT23 (DBZ) 和 SC70 (DCK) 封装以及超紧凑 X2SON (DPW) 封装。

### 器件信息<sup>(1)</sup>

器件型号	封装	封装尺寸 (标称值)
TLV803E、 TLV809E、TLV810E	SOT-23 (3)	2.90mm × 1.30mm
	SC-70 (3)	2.00mm × 1.25mm
	X2SON (5)	0.8mm × 0.8mm

(1) 如需了解所有可用封装，请参阅数据表末尾的可订购产品附录。

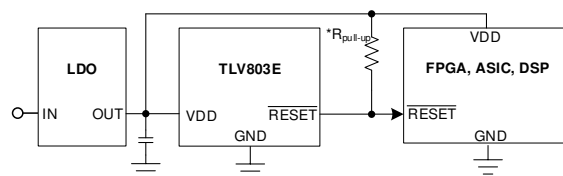

\*Pull-up resistor not required for TLV809E, TLV810E

## 典型应用



## Table of Contents

1 特性.....	1	8.4 Device Functional Modes.....	19
2 应用.....	1	<b>9 Application and Implementation</b> .....	20
3 说明.....	1	9.1 Application Information.....	20
<b>4 Revision History</b> .....	2	9.2 Typical Application - Voltage Rail Monitoring.....	20
<b>5 Device Comparison</b> .....	3	9.3 Typical Application - Overvoltage Monitoring.....	22
<b>6 Pin Configuration and Functions</b> .....	4	<b>10 Power Supply Recommendations</b> .....	23
<b>7 Specifications</b> .....	6	<b>11 Layout</b> .....	24
7.1 Absolute Maximum Ratings .....	6	11.1 Layout Guidelines.....	24
7.2 ESD Ratings .....	6	11.2 Layout Example.....	24
7.3 Recommended Operating Conditions .....	6	<b>12 Device and Documentation Support</b> .....	26
7.4 Thermal Information .....	7	12.1 Device Support.....	26
7.5 Electrical Characteristics .....	8	12.2 Documentation Support.....	27
7.6 Timing Requirements .....	9	12.3 接收文档更新通知.....	27
7.7 Timing Diagrams.....	10	12.4 支持资源.....	27
7.8 Typical Characteristics.....	11	12.5 Trademarks.....	27
<b>8 Detailed Description</b> .....	16	12.6 Electrostatic Discharge Caution.....	27
8.1 Overview.....	16	12.7 术语表.....	27
8.2 Functional Block Diagram.....	16	<b>13 Mechanical, Packaging, and Orderable Information</b> .....	27
8.3 Feature Description.....	16		

## 4 Revision History

注：以前版本的页码可能与当前版本的页码不同

Changes from Revision I (Feb 2021) to Revision J (May 2021)	Page
• Updated Device Naming Nomenclature figure by adding <i>Pinout Indicator (DBZ Package Only)</i> from <i>Pinout Indicator</i> .....	3
• Updated pin numbering of Figure 6-5 (X2SON) package and updated Pin Functions Table.....	4
• Updated X2SON (DPW) Layout Example.....	24
Changes from Revision H (December 2020) to Revision I (February 2021)	Page
• Remove duplicate package.....	27
Changes from Revision G (October 2020) to Revision H (December 2020)	Page
• Added Reset time delay variant F specification.....	9
Changes from Revision F (June 2020) to Revision G (October 2020)	Page
• 更新了整个文档中的表格、图和交叉参考的编号格式。.....	1
• 添加了附加阈值电压 ( $V_{IT-}$ ) 和新封装的信息.....	1
• Updated Device Naming Nomenclature figure to include (DBZ) V pinout option .....	3
• Added new (DBZ) package option (Pin 3 = GND, V pinout) and updated Pin Functions Table.....	4
• Added layout example for (DBZ) V pinout package.....	24
• Modified Device Naming Convention table to include additional threshold voltages ( $V_{IT-}$ ), reset time delay options and pinout indicator options.....	26
Changes from Revision E (April 2020) to Revision F (June 2020)	Page
• 将 DPW 封装从“预告信息”更改为“量产数据” .....	1
• Changed DPW package Information .....	4

**Changes from Revision D (February 2020) to Revision E (April 2020) Page**

- Added X2SON (DPW) package option ..... 3

**Changes from Revision C (November 2019) to Revision D (February 2020) Page**

- Added device nomenclature figure ..... 3
- Added timing diagram for TLV810E ..... 10
- Added Figure 6, Figure 23, Figure 24 ..... 11
- Added typical application for TLV810E ..... 22

**Changes from Revision B (July 2019) to Revision C (November 2019) Page**

- 将器件状态从“预告信息”更改为“量产数据” ..... 1

**5 Device Comparison**

图 5-1 shows the device naming nomenclature to compare the difference device variants. See 表 12-1 for a more detailed explanation.

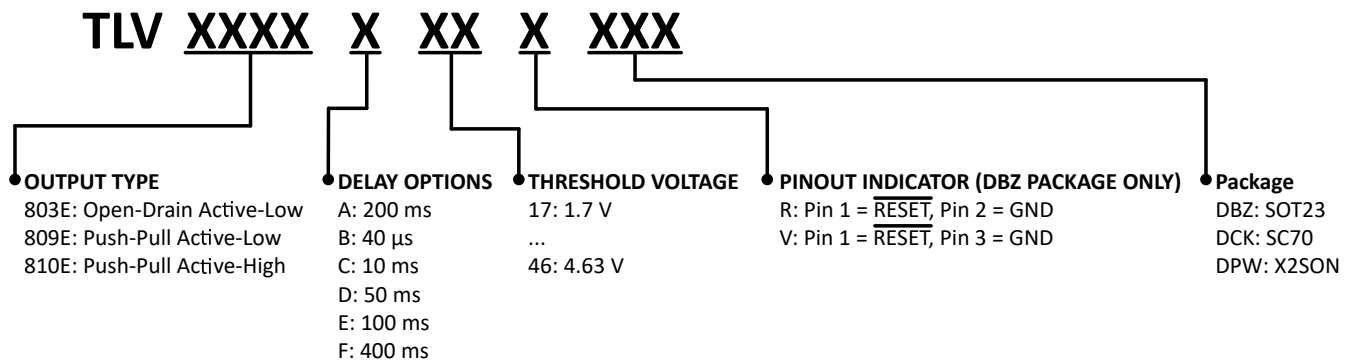

**图 5-1. Device Naming Nomenclature**

## 6 Pin Configuration and Functions

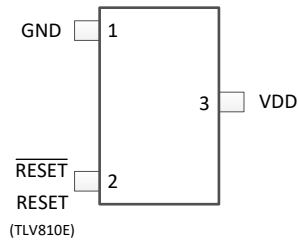

**图 6-1. DBZ Package  
(Pin 1 = GND)  
3-Pin SOT-23  
Top View**

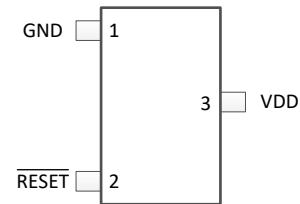

**图 6-2. DCK Package  
3-Pin SC-70  
Top View**

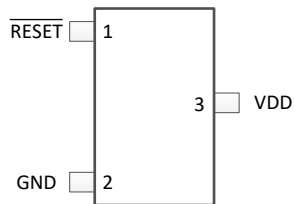

**图 6-3. DBZ Package  
(Pin 1 = RESET, R pinout)  
3-Pin SOT-23  
Top View**

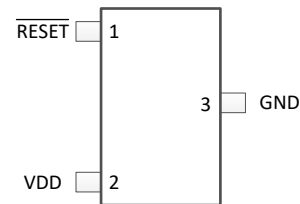

**图 6-4. DBZ Package  
(Pin 3 = GND, V pinout)  
3-Pin SOT-23  
Top View**

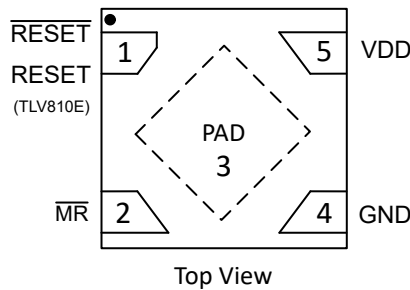

**图 6-5. DPW Package  
5-Pin X2SON  
See 表 6-1  
Top View**

表 6-1. Pin Functions

NAME	PIN				I/O	DESCRIPTION
	DCK, DBZ	DBZ (V PINOUT)	DBZ (R PINOUT)	DPW		
GND	1	3	2	4	—	<b>Ground</b>
RESET	2	1	1	1	O	<b>Active-low output reset signal:</b> This pin is driven low logic when VDD voltage falls below the negative voltage threshold ( $V_{IT-}$ ). RESET remains low (asserted) for the delay time period ( $t_D$ ) after VDD voltage rise above $V_{IT+}$ .
RESET	2	1	1	1	O	<b>Active-High output reset signal (TLV810E only):</b> This pin is driven high logic when VDD voltage falls below the negative voltage threshold ( $V_{IT-}$ ). RESET remains high (asserted) for the delay time period ( $t_D$ ) after VDD voltage rise above $V_{IT+}$ .
VDD	3	2	3	5	I	<b>Input supply voltage.</b> TLV803E, TLV809E, TLV810E monitor VDD voltage.
$\overline{MR}$	N/A	N/A	N/A	2	I	<b>Active-low manual reset input.</b> Pull this pin to a logic low ( $V_{MR_L}$ ) to assert a reset signal in the output pin. After the $\overline{MR}$ pin is left floating or pulled to $V_{MR_H}$ the output goes to the nominal state after the reset delay time ( $t_D$ ) expires. $\overline{MR}$ can be left floating when not in use.
PAD	N/A	N/A	N/A	3	—	<b>No Connection.</b> Thermal pad helps with thermal dissipation. PAD does not need to be soldered down. PAD can be connected to GND.

## 7 Specifications

### 7.1 Absolute Maximum Ratings

over operating free-air temperature range, unless otherwise noted<sup>(1)</sup>

		MIN	MAX	UNIT
Voltage	VDD pin	- 0.3	6.5	V
	RESET (TLV809E), RESET (TLV810E)	- 0.3	V <sub>DD</sub> + 0.3 <sup>(2)</sup>	V
	RESET (TLV803E)	- 0.3	6.5	V
Voltage	MR	- 0.3	V <sub>DD</sub> + 0.3 <sup>(2)</sup>	V
Current	Output sink and source current	-20	20	mA
Temperature <sup>(3)</sup>	Operating ambient, T <sub>A</sub>	- 40	125	°C
	Storage, T <sub>stg</sub>	- 65	150	

- (1) Stresses beyond those listed under *Absolute Maximum Rating* may cause permanent damage to the device. These are stress ratings only, which do not imply functional operation of the device at these or any other conditions beyond those indicated under *Recommended Operating Condition*. Exposure to absolute-maximum-rated conditions (above the Recommended Operating Conditions) for extended periods may affect device reliability.
- (2) The absolute maximum rating is (V<sub>DD</sub> + 0.3) V or 6.5 V, whichever is smaller.
- (3) As a result of the low dissipated power in this device, the junction temperature is assumed to be equal to the ambient temperature.

### 7.2 ESD Ratings

			VALUE	UNIT
V <sub>(ESD)</sub>	Electrostatic discharge	Human body model (HBM), per ANSI/ESDA/JEDEC JS-001 <sup>(1)</sup>	± 2000	V
		Charged device model (CDM), per JEDEC specification JESD22-C101 <sup>(2)</sup>	± 500	

- (1) JEDEC document JEP155 states that 500-V HBM allows safe manufacturing with a standard ESD control process.
- (2) JEDEC document JEP157 states that 250-V CDM allows safe manufacturing with a standard ESD control process.

### 7.3 Recommended Operating Conditions

over operating free-air temperature range (unless otherwise noted)

		MIN	NOM	MAX	UNIT
V <sub>DD</sub>	Input supply voltage	1.7		6	V
V <sub>RESET</sub> , V <sub>RESET</sub>	RESET pin and RESET pin voltage	0		6	V
I <sub>RESET</sub> , I <sub>RESET</sub>	RESET pin and RESET pin current	0		±5	mA
T <sub>J</sub>	Junction temperature (free air temperature)	- 40		125	°C
V <sub>MR</sub>	Manual reset pin voltage	0		V <sub>DD</sub>	V

## 7.4 Thermal Information

THERMAL METRIC <sup>(1)</sup>		TLV803E, TLV809E, TLV810E			UNIT
		DPW (X2SON)	DCK (SC70-3)	DBZ (SOT23-3)	
		5 PINS	3 PINS	3 PINS	
$R_{\theta JA}$	Junction-to-ambient thermal resistance	457.1	300.5	254.8	°C/W
$R_{\theta JC(top)}$	Junction-to-case (top) thermal resistance	201.6	178.2	150.5	°C/W
$R_{\theta JB}$	Junction-to-board thermal resistance	320.4	166.5	140.1	°C/W
$\psi_{JT}$	Junction-to-top characterization parameter	22.8	70	48.1	°C/W
$\psi_{JB}$	Junction-to-board characterization parameter	318.8	165.2	139.1	°C/W
$R_{\theta JC(bot)}$	Junction-to-case (bottom) thermal resistance	N/A	N/A	N/A	°C/W

(1) For more information about traditional and new thermal metrics, see the [Semiconductor and IC Package Thermal Metrics](#) application report.

## 7.5 Electrical Characteristics

over operating range ( $T_A = -40^\circ\text{C}$  to  $125^\circ\text{C}$ ),  $1.7\text{ V} \leq V_{DD} \leq 6\text{ V}$ ,  $R_{\text{pull-up}} = 10\text{ k}\Omega$  to  $6\text{ V}$ ,  $10\text{ pF}$  load at RESET pin, unless otherwise noted. Typical values are at  $25^\circ\text{C}$ ,  $V_{DD} = 3.3\text{ V}$  and  $V_{IT-} = 2.93\text{ V}$ .

PARAMETER		TEST CONDITIONS	MIN	TYP	MAX	UNIT
<b>COMMON PARAMETERS</b>						
$V_{DD}$	Input supply voltage		1.7		6	V
$V_{IT-}$	Input threshold voltage accuracy	$T_A = -40^\circ\text{C}$ to $125^\circ\text{C}$	-2	0.5	2	%
$V_{HYS}$	Hysteresis voltage	Hysteresis from $V_{IT-}$	0.9	1.2	1.5	%
$I_{DD}$	Supply current into VDD pin	$V_{DD} = 3.3\text{ V}$ ; $V_{DD} > V_{IT+}$ <sup>(1)</sup>		0.25	1	$\mu\text{A}$
		$V_{DD} = 6\text{ V}$		0.4	1.2	$\mu\text{A}$
$R_{MR}$	Manual reset pin internal pull-up resistance	X2SON (DPW) package only		100		$\text{k}\Omega$
$V_{MR\_L}$	Manual reset pin logic low input				0.4	V
$V_{MR\_H}$	Manual reset pin logic high input		$0.8V_{DD}$			V
<b>TLV809E (Push-Pull Active-Low)</b>						
$V_{POR}$	Power on reset voltage <sup>(2)</sup>	$V_{OL} \leq 300\text{ mV}$ , $I_{OUT(Sink)} = 15\text{ }\mu\text{A}$			700	mV
$V_{OL}$	Low level output voltage	$V_{DD} = 1.7\text{ V}$ , $V_{DD} < V_{IT-}$ , $I_{OUT(Sink)} = 500\text{ }\mu\text{A}$			300	mV
		$V_{DD} = 3.3\text{ V}$ , $V_{DD} < V_{IT-}$ , $I_{OUT(Sink)} = 2\text{ mA}$			300	mV
$V_{OH}$	High level output voltage	$V_{DD} = 6\text{ V}$ , $V_{DD} > V_{IT+}$ , $I_{OUT(Source)} = 4\text{ mA}$	$0.8V_{DD}$			V
		$V_{DD} = 3.3\text{ V}$ , $V_{DD} > V_{IT+}$ , $I_{OUT(Source)} = 2\text{ mA}$	$0.8V_{DD}$			V
<b>TLV803E (Open-Drain Active-Low)</b>						
$V_{POR}$	Power on reset voltage <sup>(2)</sup>	$V_{OL} \leq 300\text{ mV}$ , $I_{OUT(Sink)} = 15\text{ }\mu\text{A}$			700	mV
$V_{OL}$	Low level output voltage	$V_{DD} = 1.7\text{ V}$ , $V_{DD} < V_{IT-}$ , $I_{OUT(Sink)} = 500\text{ }\mu\text{A}$			300	mV
		$V_{DD} = 3.3\text{ V}$ , $V_{DD} < V_{IT-}$ , $I_{OUT(Sink)} = 2\text{ mA}$			300	mV
$I_{kg(OD)}$	Open drain output leakage current	$V_{DD} = V_{PULLUP} = 6\text{ V}$ , $V_{DD} > V_{IT+}$		100	350	nA
<b>TLV810E (Push-Pull Active-High)</b>						
$V_{OH}$	High level output voltage	$V_{DD} = 3.3\text{ V}$ , $V_{DD} < V_{IT-}$ , $I_{OUT(Source)} = 2\text{ mA}$	$0.8V_{DD}$			V
		$V_{DD} = 1.7\text{ V}$ , $V_{DD} < V_{IT-}$ , $I_{OUT(Source)} = 500\text{ }\mu\text{A}$	$0.8V_{DD}$			V
$V_{POR}$	Power on Reset Voltage	$V_{OH} \geq 720\text{ mV}$ , $I_{OUT(Source)} = 15\text{ }\mu\text{A}$			900	mV
$V_{OL}$	Low level output voltage	$V_{DD} = 6\text{ V}$ , $V_{DD} > V_{IT+}$ , $I_{OUT(Sink)} = 2\text{ mA}$			300	mV
		$V_{DD} = 3.3\text{ V}$ , $V_{DD} > V_{IT+}$ , $I_{OUT(Sink)} = 500\text{ }\mu\text{A}$			300	mV

(1)  $V_{IT+} = V_{IT-} + V_{HYS}$

(2) Minimum  $V_{DD}$  voltage for a controlled output state. Below  $V_{POR}$ , the output cannot be determined.



## 7.6 Timing Requirements

over operating range ( $T_A = -40^\circ\text{C}$  to  $125^\circ\text{C}$ ),  $1.7\text{ V} \leq V_{DD} \leq 6\text{ V}$ ,  $R_{\text{pull-up}} = 10\text{ k}\Omega$  to  $6\text{ V}$  (Open Drain only),  $10\text{ pF}$  load at RESET pin, Overdrive = 10%, unless otherwise noted. Typical values are at  $25^\circ\text{C}$ ,  $V_{DD} = 3.3\text{ V}$  and  $V_{IT-} = 2.93\text{ V}$ .

PARAMETER		TEST CONDITIONS	MIN	TYP	MAX	UNIT
$t_{GI}$	Glitch immunity	5 % Overdrive <sup>(1)</sup>		10		$\mu\text{s}$
$t_{PD\_HL}$	Propagation delay from VDD falling below $V_{IT-}$ to RESET	$V_{DD} = (V_{IT+} + 30\%)$ to $(V_{IT-} - 10\%)$		30	50	$\mu\text{s}$
$t_D$	Release time or reset timeout period	Reset time delay variant A <sup>(2)</sup>	130	200	270	ms
		Reset time delay variant B <sup>(2)</sup> ; $R_{UP} = 100\text{ k}\Omega$ , $C_L = 100\text{ pF}$ , 30% Overdrive <sup>(3)</sup>		45	90	$\mu\text{s}$
		Reset time delay variant B <sup>(2)</sup>		40	80	$\mu\text{s}$
		Reset time delay variant C <sup>(2)</sup>	6.5	10	13.5	ms
		Reset time delay variant D <sup>(2)</sup>	33	50	67	ms
		Reset time delay variant F <sup>(2)</sup>	260	400	540	ms
$t_{MR\_PW}$ <sup>(4)</sup>	$\overline{MR}$ pin pulse duration to initiate RESET, RESET			500		ns
$t_{MR\_RES}$ <sup>(4)</sup>	Propagation delay from $\overline{MR}$ low to RESET, RESET	$V_{DD} = 4.5\text{ V}$ , $V_{MR} : V_{MR\_H}$ to $V_{MR\_L}$		700		ns
$t_{MR\_TD}$ <sup>(4)</sup>	Delay from release $\overline{MR}$ to deassert RESET, RESET	$V_{DD} = 4.5\text{ V}$ , $V_{MR} : V_{MR\_L}$ to $V_{MR\_H}$	$t_{D\_MIN}$	$t_{D\_TYP}$	$t_{D\_MAX}$	ms

- (1) Overdrive =  $[(V_{DD}/V_{IT-}) - 1] \times 100\%$ . Refer to section on [VDD glitch immunity](#)  
(2) Refer to [Device nomenclature table](#). VDD:  $(V_{IT-}-10\%)$  to  $(V_{IT+} + 10\%)$   
(3) Specified by design  
(4) X2SON Package only

### 7.7 Timing Diagrams



图 7-1. TLV803E, TLV809E Timing Diagram



图 7-2. TLV810E Timing Diagram

## 7.8 Typical Characteristics

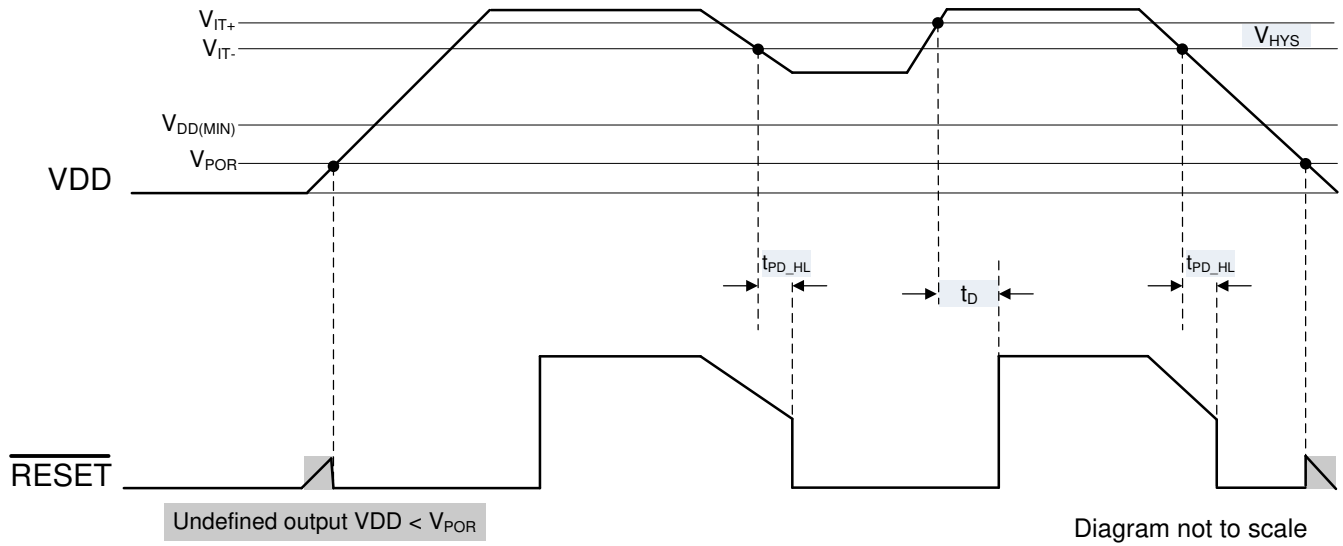
Typical characteristics show the typical performance of the TLV803E, TLV809E, and TLV810E devices. Test conditions are  $T_A = 25^\circ\text{C}$ ,  $V_{DD} = 3.3\text{ V}$ ,  $V_{IT-} = 2.93\text{ V}$ ,  $R_{\text{pull-up}} = 10\text{ k}\Omega$  to  $6\text{ V}$ ,  $C_{\text{Load}} = 50\text{ pF}$ , unless otherwise noted.

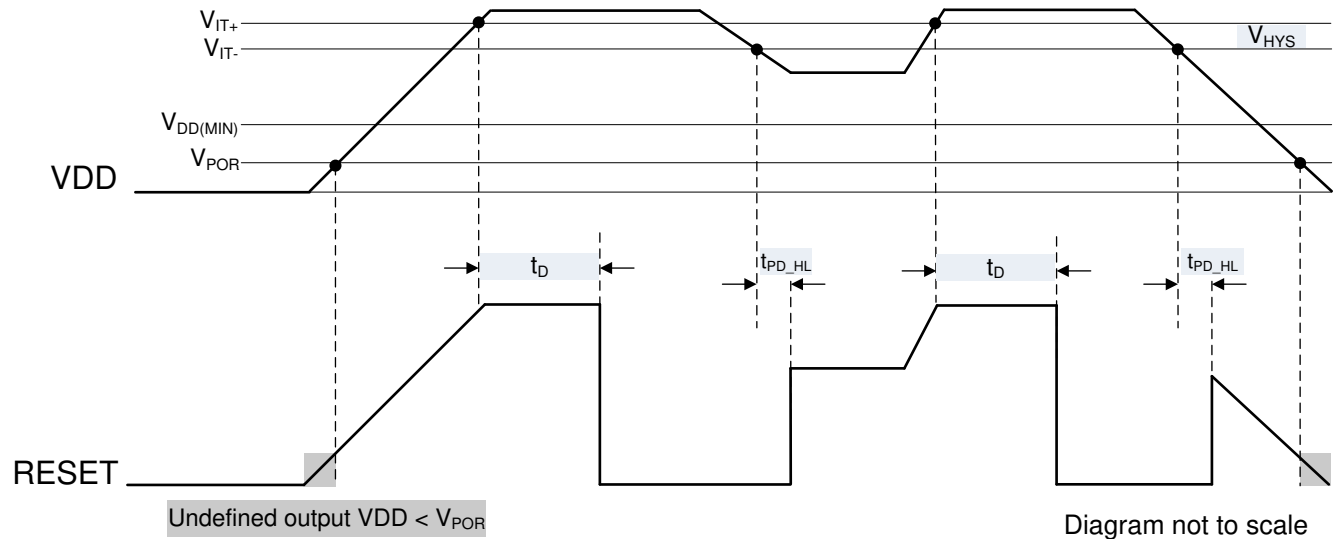

图 7-3. Supply Current Versus Supply Voltage for TLV803EA29



图 7-4. Supply Current Versus Supply Voltage for TLV809EA29

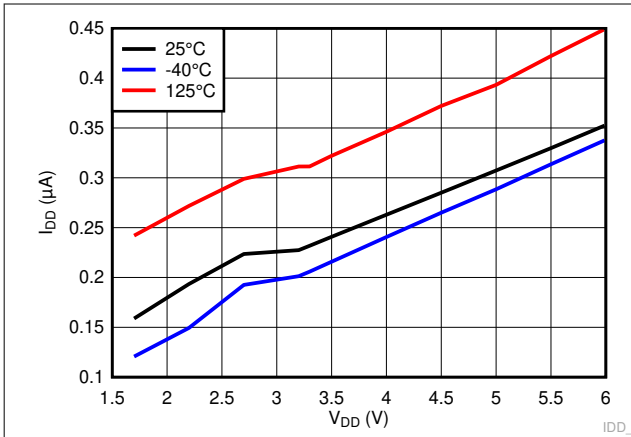

图 7-5. Supply Current Versus Supply Voltage for TLV810EA29

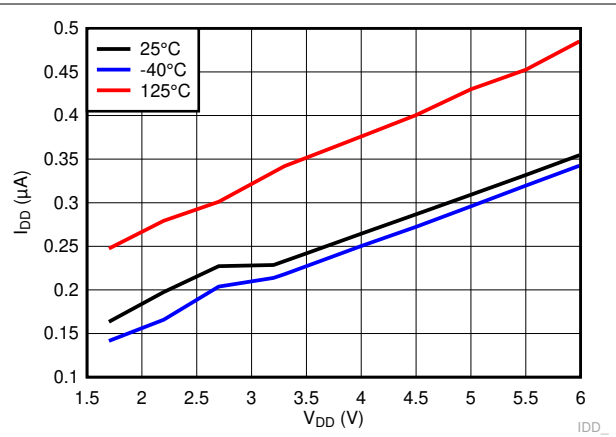

图 7-6. Supply Current Verses Temperature for TLV803EA29,  $V_{DD} = 3.3\text{ V}$

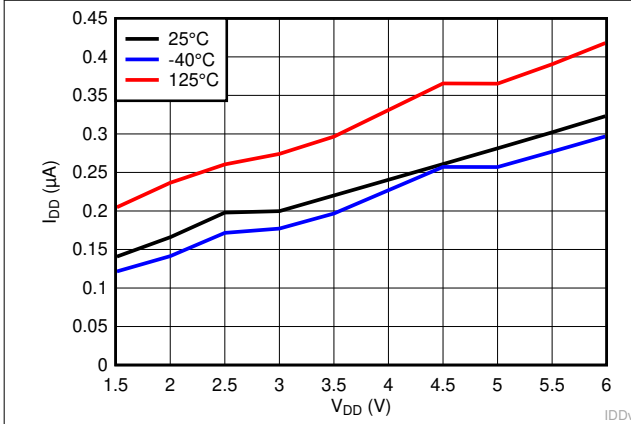

图 7-7. Supply Current Verses Temperature for TLV809EA29,  $V_{DD} = 3.3\text{ V}$

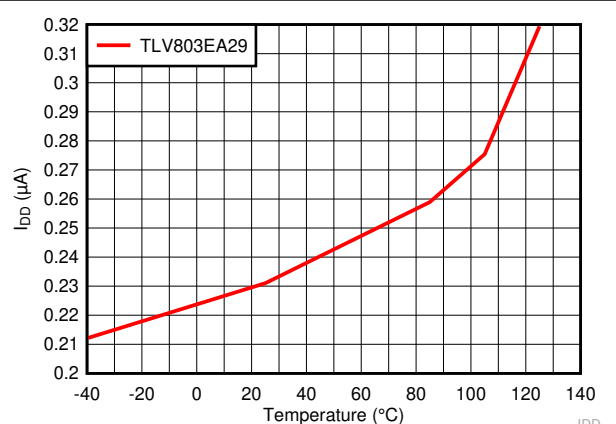

图 7-8. Leakage Current Verses Temperature for TLV803EA29

### 7.8 Typical Characteristics (continued)

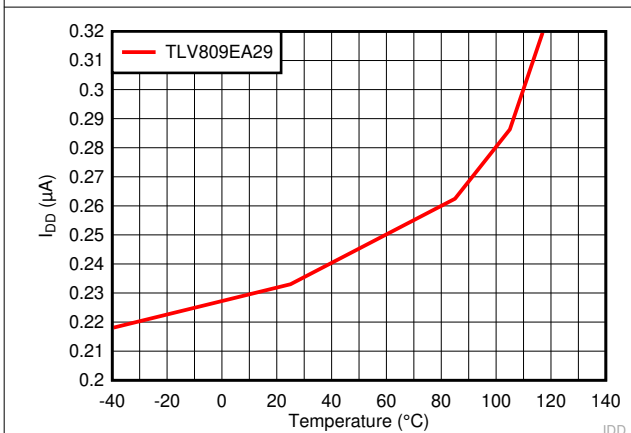
Typical characteristics show the typical performance of the TLV803E, TLV809E, and TLV810E devices. Test conditions are  $T_A = 25^\circ\text{C}$ ,  $V_{DD} = 3.3\text{ V}$ ,  $V_{IT-} = 2.93\text{ V}$ ,  $R_{\text{pull-up}} = 10\text{ k}\Omega$  to  $6\text{ V}$ ,  $C_{\text{Load}} = 50\text{ pF}$ , unless otherwise noted.

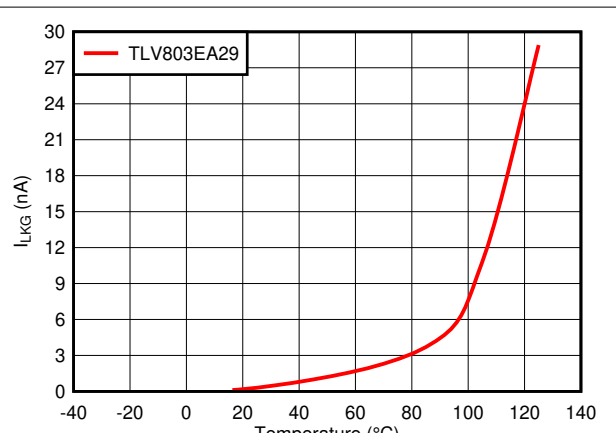

图 7-9. Voltage Threshold Accuracy Verses Temperature for TLV803EA29



图 7-10. Voltage Threshold Accuracy Verses Temperature for TLV809EA29

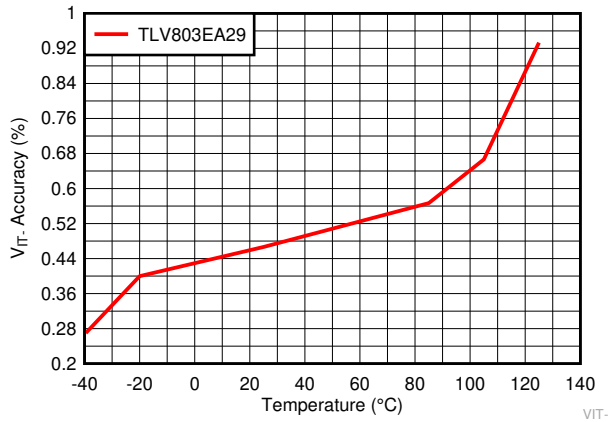

图 7-11. Low Voltage Output Versus Output Current for TLV803EA29,  $V_{DD} = 1.7\text{ V}$

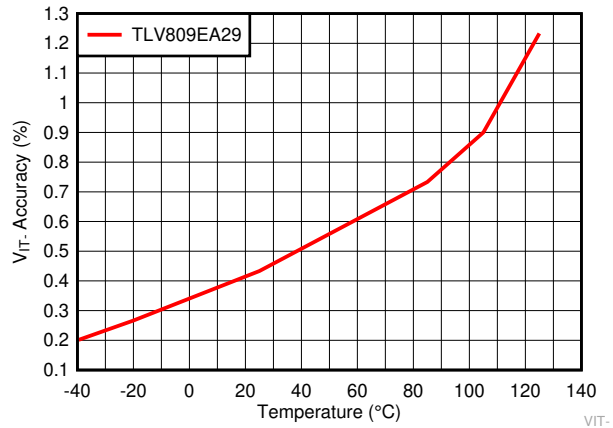

图 7-12. Low Voltage Output Versus Output Current for TLV809EA29,  $V_{DD} = 1.7\text{ V}$

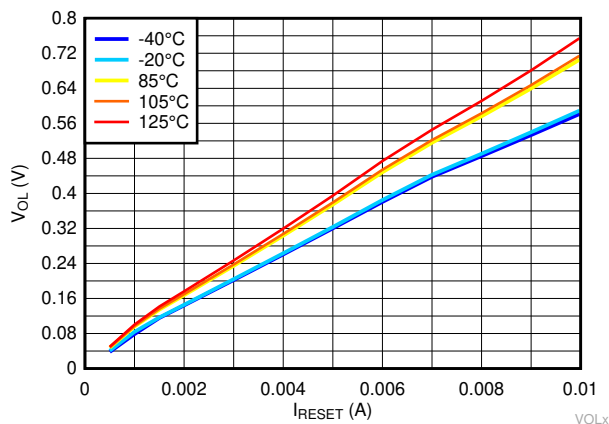

图 7-13. Low Voltage Output Verses Temperature for TLV803EA29,  $V_{DD} = 1.7\text{ V}$

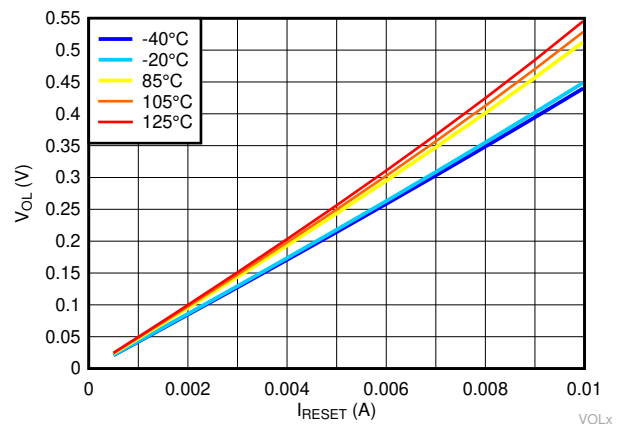

图 7-14. Low Voltage Output Verses Temperature for TLV809EA29,  $V_{DD} = 1.7\text{ V}$

## 7.8 Typical Characteristics (continued)

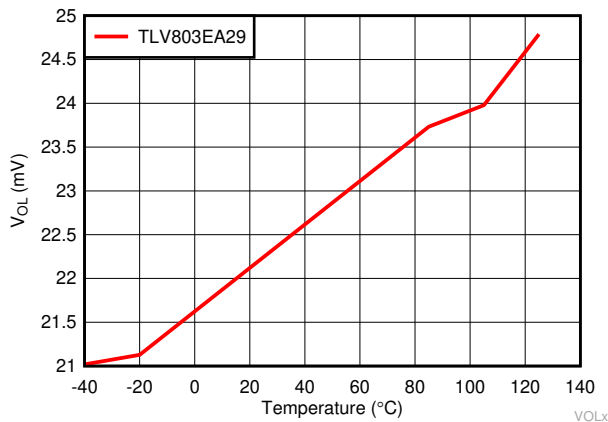
Typical characteristics show the typical performance of the TLV803E, TLV809E, and TLV810E devices. Test conditions are  $T_A = 25^\circ\text{C}$ ,  $V_{DD} = 3.3\text{ V}$ ,  $V_{IT-} = 2.93\text{ V}$ ,  $R_{\text{pull-up}} = 10\text{ k}\Omega$  to  $6\text{ V}$ ,  $C_{\text{Load}} = 50\text{ pF}$ , unless otherwise noted.

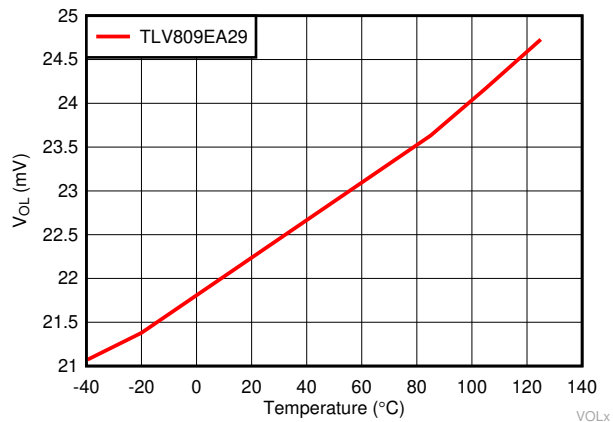

图 7-15. High Voltage Output Versus Output Current for TLV809EA29,  $V_{DD} = 6\text{ V}$



图 7-16. High Voltage Output Versus Temperature for TLV809EA29,  $V_{DD} = 3.3\text{ V}$

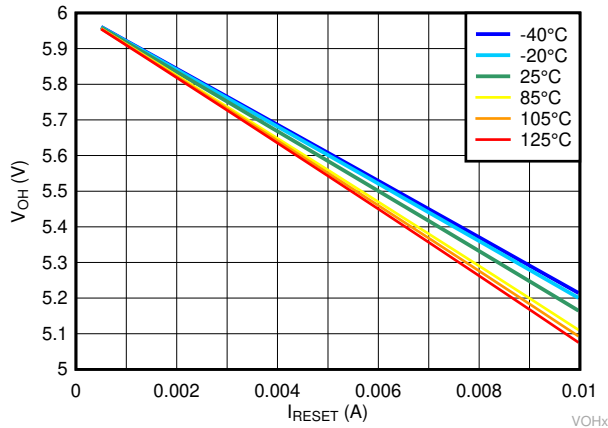

图 7-17. Reset Voltage Output Versus Voltage Input for TLV803EA29,  $V_{\text{pull-up}} = V_{DD}$ ,  $R_{\text{pull-up}} = 10\text{ k}\Omega$

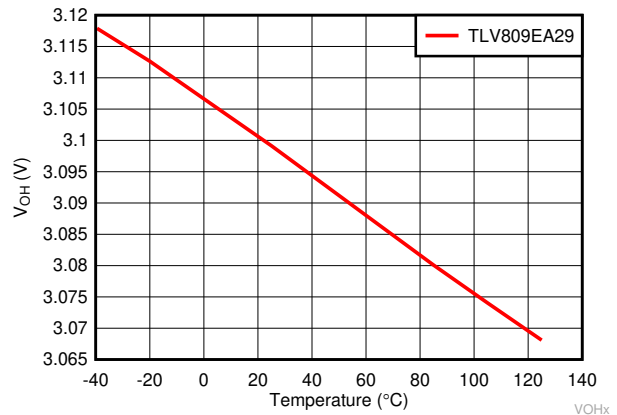

图 7-18. Reset Voltage Output Versus Voltage Input for TLV803EA29,  $R_{\text{pull-up}} = 10\text{ k}\Omega$

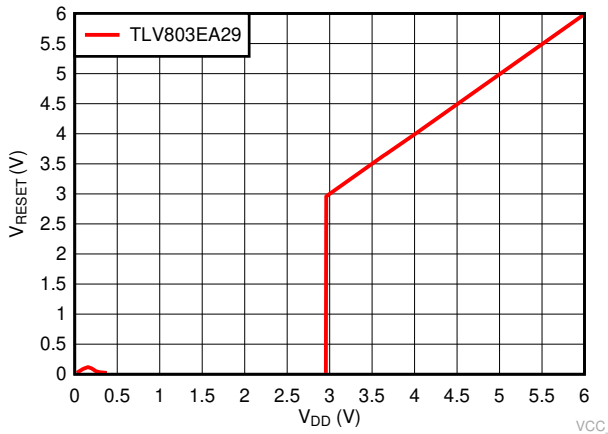

图 7-19. Transient Power-on-Reset Voltage for TLV809EA30,  $I_{\text{RESET}} = 15\text{ }\mu\text{A}$

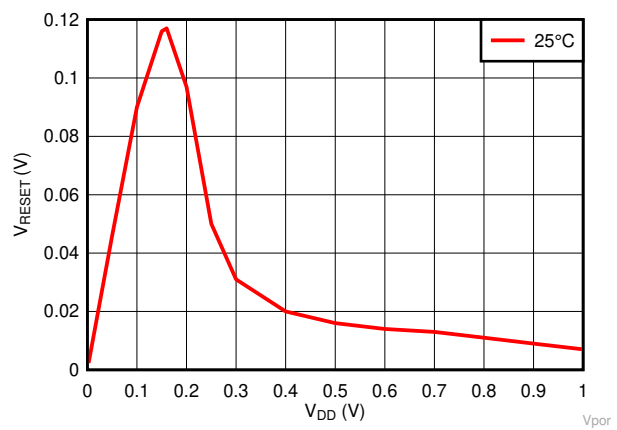

图 7-20. Reset Delay Time Versus Temperature for TLV803EA29

### 7.8 Typical Characteristics (continued)

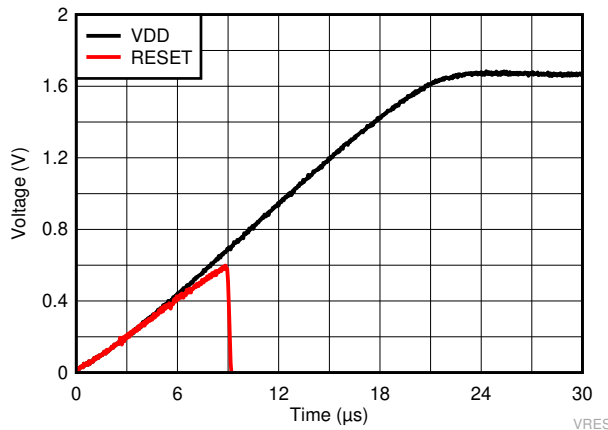
Typical characteristics show the typical performance of the TLV803E, TLV809E, and TLV810E devices. Test conditions are  $T_A = 25^\circ\text{C}$ ,  $V_{DD} = 3.3\text{ V}$ ,  $V_{IT-} = 2.93\text{ V}$ ,  $R_{\text{pull-up}} = 10\text{ k}\Omega$  to  $6\text{ V}$ ,  $C_{\text{Load}} = 50\text{ pF}$ , unless otherwise noted.

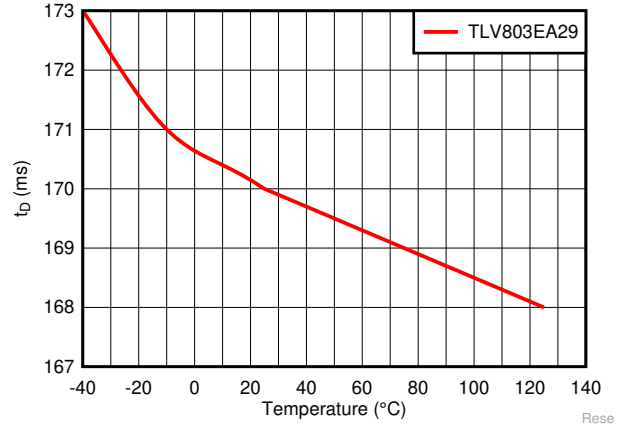

图 7-21. Reset Delay Time Versus Temperature for TLV809EA29



图 7-22. Reset Delay Time Versus Temperature for TLV803EB29

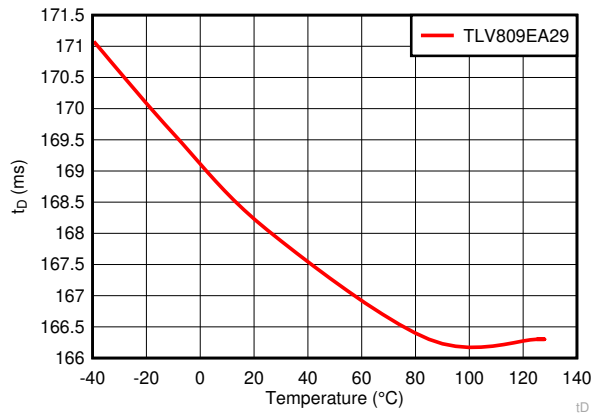

图 7-23. Reset Delay Time Versus Temperature for TLV803EC29

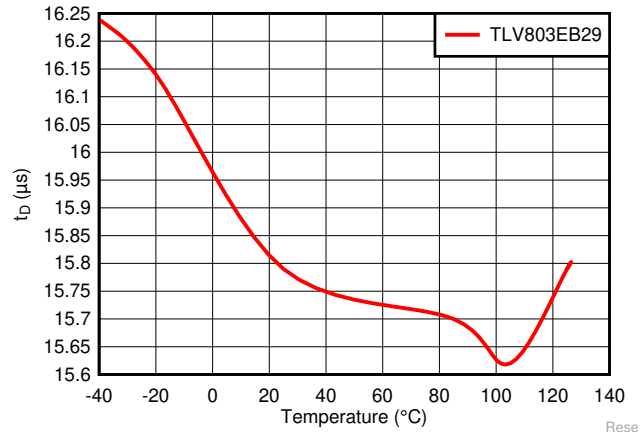

图 7-24. High-to-Low Propagation Delay Versus Temperature for TLV803EA29

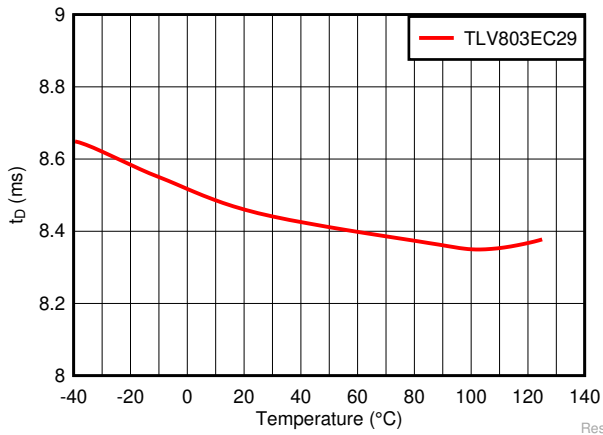

图 7-25. High-to-Low Propagation Delay Versus Temperature for TLV809EA29

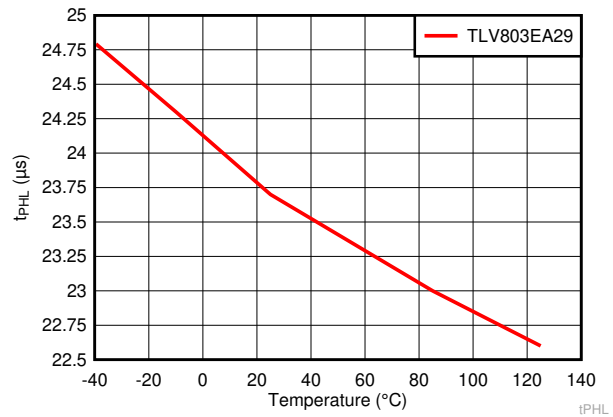

图 7-26. Glitch Immunity Versus Overdrive for TLV803EA29

### 7.8 Typical Characteristics (continued)

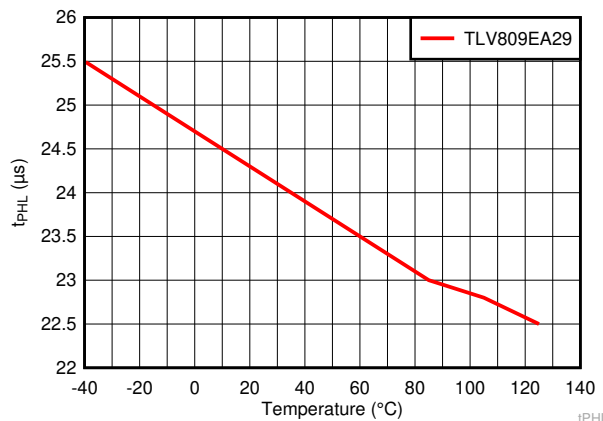
Typical characteristics show the typical performance of the TLV803E, TLV809E, and TLV810E devices. Test conditions are  $T_A = 25^\circ\text{C}$ ,  $V_{DD} = 3.3\text{ V}$ ,  $V_{IT-} = 2.93\text{ V}$ ,  $R_{\text{pull-up}} = 10\text{ k}\Omega$  to  $6\text{ V}$ ,  $C_{\text{Load}} = 50\text{ pF}$ , unless otherwise noted.

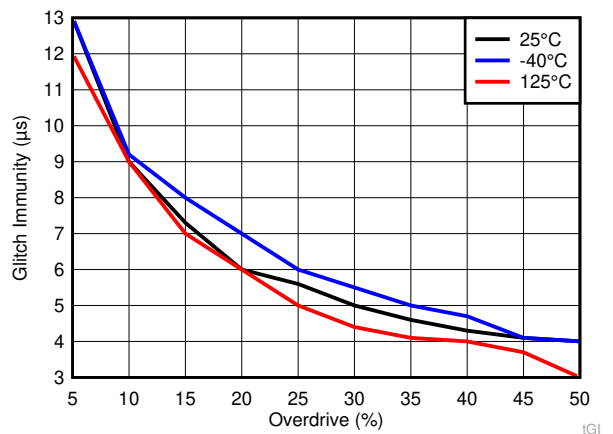

图 7-27. Glitch Immunity Versus Overdrive for TLV809EA29

## 8 Detailed Description

### 8.1 Overview

The TLV803E, TLV809E, TLV810E is a family of easy to implement low power, small size voltage supervisors (Reset ICs) with fixed threshold voltage and fixed reset delay. The TLV803E has open-drain active-low output topology which requires an external pull-up resistor, TLV809E has push-pull active-low output topology and TLV810E has push-pull active-high output topology. This family of devices features include integrated resistor divider threshold with hysteresis and a glitch immunity filter.

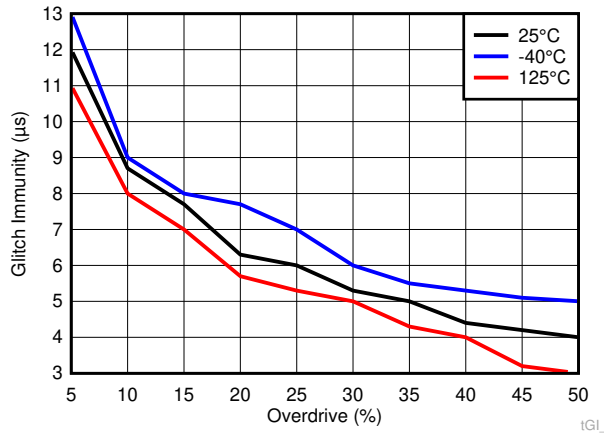
These devices are available in SOT-23 (3) and SC70 (3) industry standard package and pinout as well as a very small X2SON (5) package.

### 8.2 Functional Block Diagram

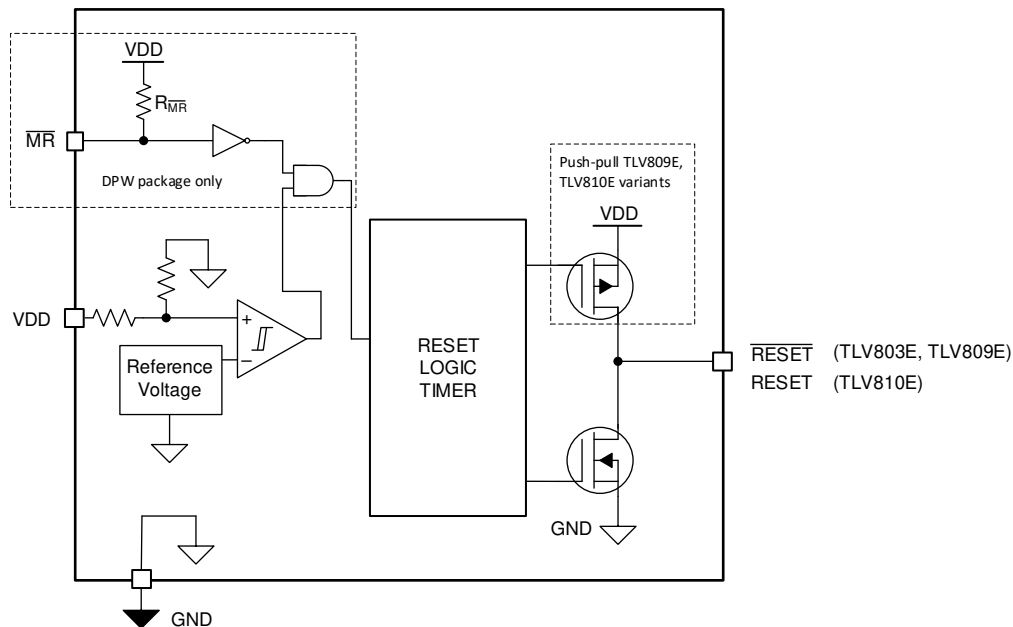

### 8.3 Feature Description

#### 8.3.1 Input Voltage (VDD)

VDD pin is monitored by the internal comparator with integrated reference to indicate when VDD falls below the fixed threshold voltage. VDD also functions as the supply for the following:

- Internal bandgap (reference voltage)
- Internal regulator
- State machine
- Buffers
- Other control logic blocks

Good design practice involves placing a 0.1- $\mu$ F to 1- $\mu$ F bypass capacitor at VDD input for noisy applications and to ensure enough charge is available for the device to power up correctly. The reset output is undefined when VDD is below  $V_{POR}$ .



### 8.3.2 VDD Hysteresis

The internal comparator has built-in hysteresis to avoid erroneous output reset release. If the voltage at the VDD pin falls below the falling voltage threshold  $V_{IT-}$ , the output reset is asserted. When the voltage at the VDD pin rises above the rising voltage threshold ( $V_{IT+}$ ) equivalent to  $V_{IT-}$  plus hysteresis ( $V_{HYS}$ ), the output reset is deasserted after  $t_D$  reset time delay.

### 8.3.3 VDD Glitch Immunity

These devices are immune to quick voltage transient or excursion on VDD. Sensitivity to transients depends on both pulse duration ( $t_{GI}$ ) found in § 7.6 and transient overdrive. Overdrive is defined by how much VDD exceeds the specified threshold. Threshold overdrive is calculated as a percent of the threshold in question, as shown in 方程式 1.

$$\text{Overdrive} = | (VDD / (V_{IT-} - 1)) \times 100\% | \quad (1)$$

where

- $V_{IT-}$  is the threshold voltage
- VDD is the input voltage crossing  $V_{IT-}$



图 8-1. Overdrive Versus Pulse Duration

TLV803E, TLV809E, and TLV810E devices have built-in glitch immunity ( $t_{GI}$ ) of 10  $\mu$ s typical as shown in § 7.6. 图 8-2 shows that VDD must fall below  $V_{IT-}$  for  $t_{GI}$ , otherwise the falling transition is ignored. When VDD falls below  $V_{IT-}$  for  $t_{GI}$ ,  $\overline{\text{RESET}}$  transitions low to indicate a fault condition after the propagation delay high-to-low ( $t_{PDHL}$ ). When VDD rises above  $V_{IT+}$ ,  $\overline{\text{RESET}}$  only deasserts to logic high indicating there is no more fault condition only if VDD remains above  $V_{IT+}$  for longer than the reset delay ( $t_D$ ).

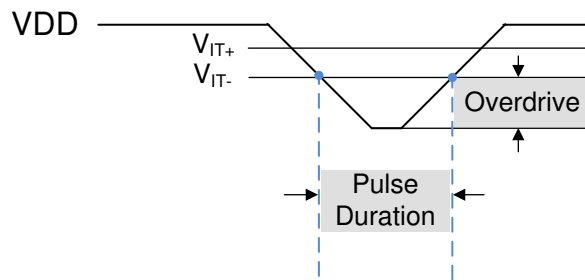

图 8-2. Glitch Immunity when VDD Rises Above  $V_{IT+}$  for Less than  $\overline{\text{RESET}}$  Delay (TLV803EA29)

### 8.3.4 Manual Reset ( $\overline{\text{MR}}$ ) Input for X2SON (DPW) Package Only

The manual reset ( $\overline{\text{MR}}$ ) input allows a processor GPIO or other logic circuits to initiate a reset. A logic low on  $\overline{\text{MR}}$  with pulse duration longer than  $t_{\text{MR\_RES}}$  will cause reset output to assert. After  $\overline{\text{MR}}$  returns to a logic high ( $V_{\text{MR\_H}}$ ) and VDD is above  $V_{\text{IT+}}$ , reset is deasserted after the user programmed reset time delay ( $t_{\text{D}}$ ) expires.

If  $\overline{\text{MR}}$  is not controlled externally, then  $\overline{\text{MR}}$  can be left disconnected.  $\overline{\text{MR}}$  is internally connected to VDD through a pull-up resistor  $R_{\text{MR}}$  shown in 节 8.2. If the logic signal controlling  $\overline{\text{MR}}$  is less than VDD, then additional current flows from VDD into  $\overline{\text{MR}}$  internally. For minimum current consumption, drive  $\overline{\text{MR}}$  to either VDD or GND.  $V_{\text{MR}}$  should not be higher than VDD voltage.

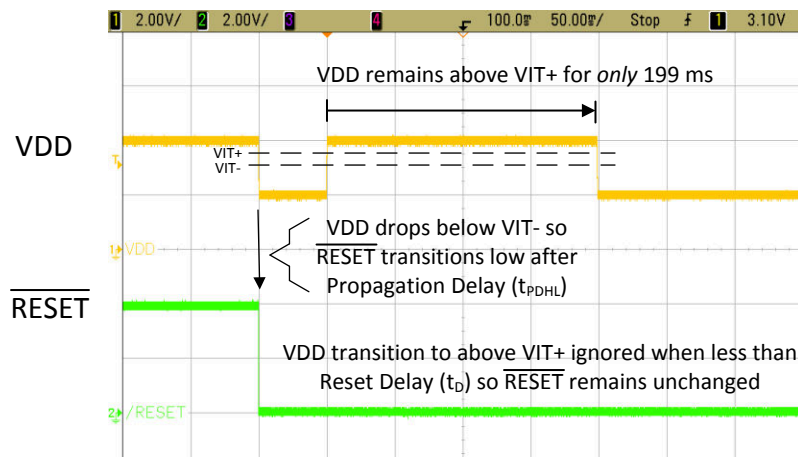

图 8-3. Timing Diagram  $\overline{\text{MR}}$  and  $\overline{\text{RESET}}$  for X2SON (DPW) Package

### 8.3.5 Output Logic

#### 8.3.5.1 $\overline{\text{RESET}}$ Output, Active-Low

$\overline{\text{RESET}}$  remains high (deasserted) as long as VDD is above the negative threshold ( $V_{\text{IT-}}$ ). If VDD falls below the negative threshold ( $V_{\text{IT-}}$ ), then reset is asserted and  $\overline{\text{RESET}}$  transitions to logic low ( $V_{\text{OL}}$ ).

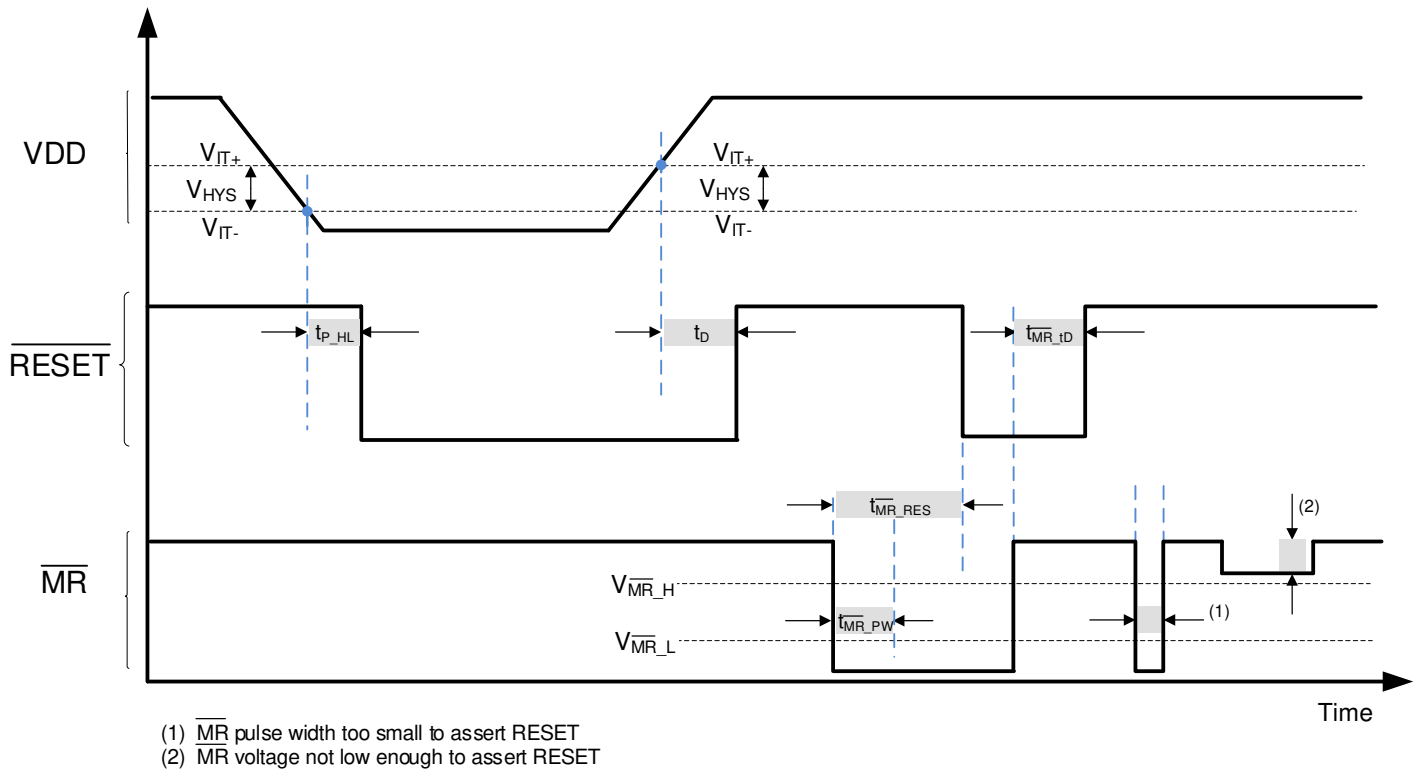
When VDD rises above  $V_{\text{IT+}}$ , the delay circuit holds  $\overline{\text{RESET}}$  active and logic low for the specified reset delay period ( $t_{\text{D}}$ ). When the reset delay has elapsed, the  $\overline{\text{RESET}}$  pin transitions to high voltage ( $V_{\text{OH}}$ ).

The open-drain version requires an external pull-up resistor to hold the  $\overline{\text{RESET}}$  pin high because the internal MOSFET turns off causing  $\overline{\text{RESET}}$  output to pull-up to the pull-up voltage. Connect the pull-up resistor to the desired interface voltage logic.  $\overline{\text{RESET}}$  can be pulled up to any voltage up to maximum voltage independent of the VDD voltage. To ensure proper voltage levels, take care when choosing the pull-up resistor values. The pull-up resistor value is determined by  $V_{\text{OL}}$ , the output capacitive loading, and the output leakage current ( $I_{\text{lk}}(\text{OD})$ ).

The push-pull variant does not require an external pull-up resistor.

### 8.3.5.2 RESET Output, Active-High

RESET remains logic low (deasserted) as long as VDD is above the positive threshold ( $V_{IT+}$ ). If VDD falls below the negative threshold ( $V_{IT-}$ ), then reset is asserted and RESET transitions to logic high ( $V_{OH}$ ).

When VDD rises above  $V_{IT+}$ , the delay circuit holds RESET active and logic high for the specified reset delay period ( $t_D$ ). When the reset delay has elapsed the RESET pin transitions to low voltage ( $V_{OL}$ ).

## 8.4 Device Functional Modes

表 8-1 summarizes the various functional modes of the device.

表 8-1. Truth Table

V <sub>DD</sub>	$\overline{MR}$ (X2SON package only)	RESET (Active-High)	RESET(Active-Low)
$V_{DD} < V_{POR}$	N/A	Undefined	Undefined
$V_{POR} < V_{DD} < V_{IT-}$ <sup>(1)</sup>	N/A	H	L
$V_{DD} \geq V_{IT-}$	L	H	L
$V_{DD} \geq V_{IT-}$	H	L	H

(1) When V<sub>DD</sub> falls below V<sub>DD(MIN)</sub>, output reset is held asserted until V<sub>DD</sub> falls below V<sub>POR</sub>.

### 8.4.1 Normal Operation (VDD > V<sub>DD(min)</sub>)

When VDD voltage is greater than V<sub>DD(min)</sub>, the reset signal is determined by the voltage on the VDD pin with respect to the trip point ( $V_{IT-}$ ) and the  $\overline{MR}$  pin voltage (X2SON package only).

### 8.4.2 VDD Between VPOR and V<sub>DD(min)</sub>

When the voltage on VDD is less than the V<sub>DD(min)</sub> voltage and greater than the power-on-reset voltage (V<sub>POR</sub>), the reset signal is asserted.

### 8.4.3 Below Power-On-Reset (VDD < V<sub>POR</sub>)

When the voltage on VDD is lower than V<sub>POR</sub>, the device does not have enough bias voltage to internally pull the asserted output low or high and reset voltage level is undefined.

## 9 Application and Implementation

### 备注

以下应用部分中的信息不属于 TI 器件规格的范围，TI 不承担其准确性和完整性。TI 的客户应负责确定器件是否适用于其应用。客户应验证并测试其设计，以确保系统功能。

### 9.1 Application Information

The TLV803E, TLV809E, and TLV810E devices are used for voltage monitoring. These devices have only three pins: VDD, GND, and RESET (or RESET for TLV810E). There are at the most two external components: a capacitor on the VDD pin and a pull-up resistor on the RESET/RESET to VDD or another pull-up voltage for the open-drain variants. The design involves choosing the device with the desired voltage threshold and output topology and adding these components, if needed, as explained in the following sections.

### 9.2 Typical Application - Voltage Rail Monitoring

A typical application for TLV803E, TLV809E, and TLV810E devices is voltage rail monitoring. This rail can be the input power supply or the output of an LDO or DC/DC converter. 图 9-1 shows the TLV803EA29 monitoring the supply rail for a DSP, FPGA, or ASIC. This rail is at 3.3 V and generated by an LDO with an input power supply of 5 V. The supervisor is needed to make sure that the supply to the MCU/ASIC/FPGA/DSP is above a certain voltage threshold. If the supply voltage drops below a certain threshold, supervisor generates a reset output to indicate to the MCU that the supply is going down so that the MCU can take actions to save register data before supply enters brown-out conditions.



图 9-1. The Output of LDO Powering the MCU is Monitored by the TLV803EA29

#### 9.2.1 Design Requirements

This design monitors a 3.3-V rail and flags an undervoltage fault at the RESET output when supply rail falls approximately 12% below the nominal rail voltage. The TLV803E device has an open-drain output topology so an external pull-up resistor is required and is calculated to ensure that  $V_{OL}$  does not exceed max limit given the  $I_{RESET/RESET}$  spec of  $\pm 5$  mA is not violated at the expected supply voltage. 表 7.5 provides 500  $\mu$ A Isink for 1.7 V VDD, which is the closest voltage to this design example. Using 500  $\mu$ A of Isink and 300 mV max  $V_{OL}$ , gives us 5.36k $\Omega$  for the external pull-up resistor. Any value greater than 5.36k $\Omega$  would ensure that  $V_{OL}$  will not exceed 300 mV max specification. If you are using the TLV809E device variant, no pull-up resistor is required because TLV809E has push-pull output topology.

### 9.2.2 Detailed Design Procedure

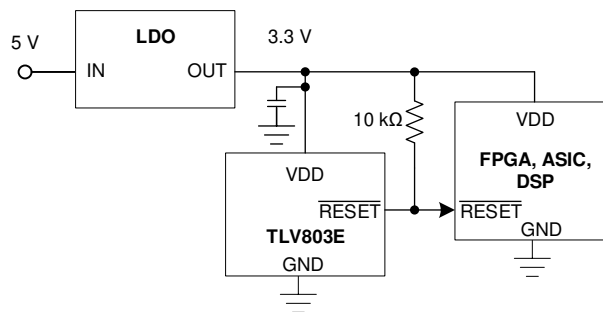
Select the TLV803EA29DBZR to satisfy the voltage threshold requirement for 3.3-V rail monitoring. As mentioned in 表 12-1, the TLV803EA29DBZR triggers an undervoltage fault at the  $\overline{\text{RESET}}$  output when VDD falls below  $V_{IT-}$ , which is 2.93 V for this device variant. Place a pull-up resistor on  $\overline{\text{RESET}}$  to VDD to satisfy the output logic requirement while not violating the  $I_{\text{RESET}}$  recommended limit.

### 9.2.3 Application Curves

图 9-2 and 图 9-3 show the TLV803EA29 functionality. In 图 9-2, the VDD supply voltage drops from 30% above  $V_{IT-} = 3.8$  V to 10% below  $V_{IT-} = 2.6$  V with a 0.1- $\mu\text{F}$  capacitor on VDD. The  $\overline{\text{RESET}}$  output is connected to VDD through the pull-up resistor so when the VDD supply voltage drops. The  $\overline{\text{RESET}}$  output discharges down to the VDD supply voltage through the pull-up resistor and  $\overline{\text{RESET}}$  pin capacitance. Once the high-to-low propagation delay  $t_{\text{PD\_HL}}$  expires, the internal MOSFET turns on and asserts  $\overline{\text{RESET}}$  to logic low. Note that  $t_{\text{PD\_HL}}$  varies with VDD specifically on how much VDD drops and how quickly in addition to the VDD and  $\overline{\text{RESET}}$  pin capacitances. In 图 9-3, VDD rises from 2 V to 4 V and the  $\overline{\text{RESET}}$  output deasserts to logic high after the reset delay time ( $t_D$ ) expires.

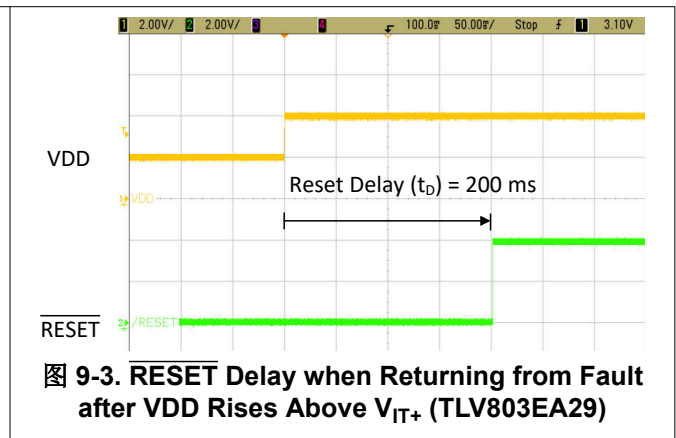
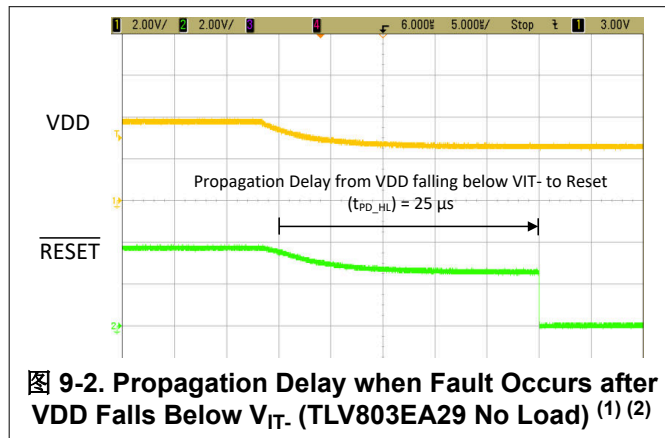

1. Typical  $t_{\text{PD\_HL}} = 30 \mu\text{s}$  for VDD falling from ( $V_{IT+} + 30\%$ ) to ( $V_{IT-} - 10\%$ ).
2. VDD does not fall all the way to 0 V so  $\overline{\text{RESET}}$  momentarily discharges to VDD until  $t_{\text{PD\_HL}}$  expires.

### 9.3 Typical Application - Overvoltage Monitoring

A typical use case for the push-pull active-high device variant TLV810E is overvoltage monitoring. The TLV810E can monitor a power supply, a MCU power rail, or a battery during charging for example. The VDD pin monitors the voltage rail and once VDD rises above  $V_{IT+}$ , the RESET output deactivates to logic low after the reset delay time  $t_D$ . If VDD falls below  $V_{IT-}$ , the RESET output activates to logic high after the propagation delay ( $t_{PD\_HL}$ ). The voltage thresholds and the reset delay time depends on the device variant. See [节 5](#) for device variant naming nomenclature.



图 9-4. TLV810E Overvoltage Monitor Circuit for Battery Charger

#### 9.3.1 Design Requirements

In this application design, the TLV810E device is monitoring a 3 V battery connected to a battery charger. The battery charger turns on when the battery voltage is below 2.93 V and turns off once the battery charges to 2.96 V and remains above 2.96 V for at least 200 ms. The design must be low power and not consume more than 500 nA typical.

#### 9.3.2 Detailed Design Procedure

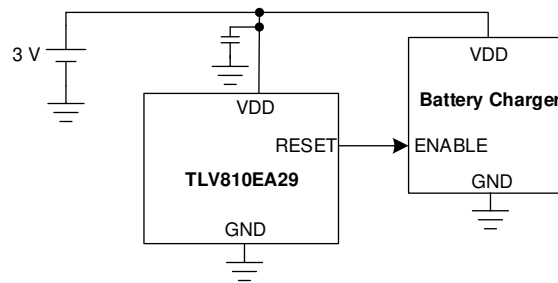
Select the TLV810EA29 to accomplish this design. The TLV810EA29 is a push-pull active-high device with a  $V_{IT-} = 2.9$  V and  $V_{IT+} = 2.9 + 1.2\% = 2.93$  V. Because the device is a push-pull output and the device threshold meets the design requirements, no external resistors are needed. The TLV810EA29 device variant comes with 200 ms reset delay time meaning VDD must be above  $V_{IT+}$  for at least 200 ms for the RESET output to transition to logic low to turn off the battery charger. This device meets the low power requirement because the TLV810E only consumes 250 nA typical.

## 10 Power Supply Recommendations

These devices are designed to operate from an input supply range of 1.7 V to 6 V. An input supply capacitor is recommended between the VDD pin and GND pin. If the voltage supply that provides power to VDD is susceptible to any large voltage transient that can exceed VDD maximum, the user must take additional precautions.

## 11 Layout

### 11.1 Layout Guidelines

Make sure that the connection to the VDD pin is low impedance. Good analog design practice recommends placing a minimum 0.1- $\mu$ F ceramic capacitor as close to the VDD pin as possible. A pull-up resistor is required for the open-drain output. Place the pull-up resistor on the  $\overline{\text{RESET}}$  pin as close to the pin as possible.

### 11.2 Layout Example



图 11-1. TLV803E, TLV809E, and TLV810E SOT23 (DBZ) Layout Example



Pull-up resistor required for Open-Drain output

图 11-2. TLV803E, TLV809E, and TLV810E SOT23 (DBZ) V pinout Layout Example

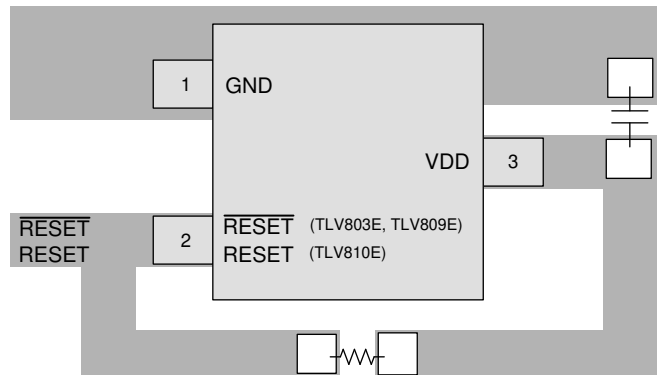
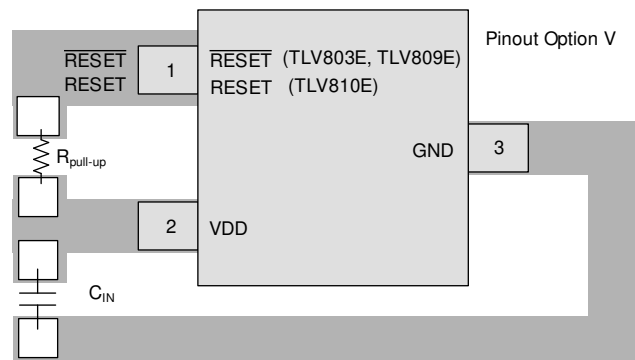



图 11-3. TLV803E, TLV809E, and TLV810E X2SON (DPW) Layout Example

## 12 Device and Documentation Support

### 12.1 Device Support

#### 12.1.1 Device Nomenclature

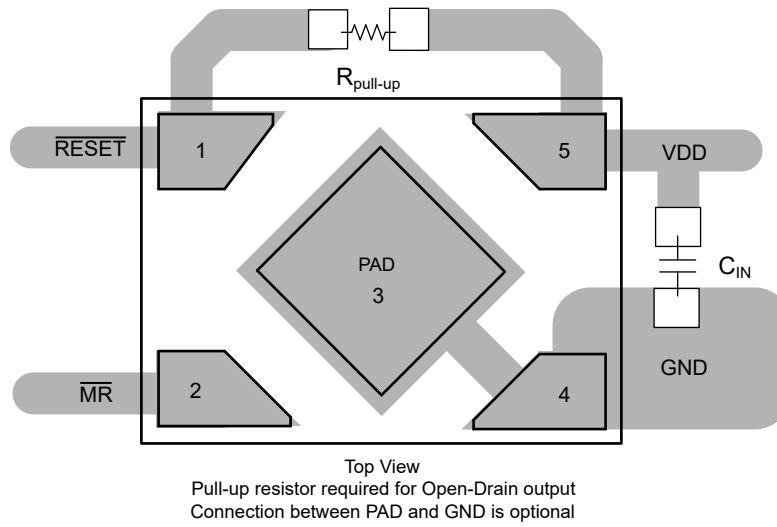
表 12-1 shows how to decode the function of the device based on its part number. For example: TLV803EA29DBZR is open-drain, active-low, 200 ms reset delay, 2.93 V threshold voltage, Pin 1 = GND, SOT23-3 pin package, and large reel option.

表 12-1 shows all the possible variants of the TLV80xE and TLV81xE. Refer to the orderable device information table for the options available to order. Contact Texas Instruments for the details and availability of devices not in the orderable device information table.

表 12-1. Device Naming Convention

DESCRIPTION	NOMENCLATURE	VALUE
Part Number	TLV803E	Open-Drain, Active-Low
	TLV809E	Push-Pull, Active-Low
	TLV810E	Push-Pull, Active-High
Reset Time Delay Option	A	200 ms
	B	40 $\mu$ s
	C	10 ms
	D	50 ms
	F	400 ms
Threshold Voltage Option	17	1.7 V
	18	1.8 V
	19	1.9 V
	22	2.25 V
	24	2.4 V
	26	2.64 V
	29	2.93 V
	30	3.08 V
	33	3.3 V
	42	4.2 V
	43	4.38 V
	45	4.55 V
Pinout Indicator (DBZ Package Only)	R	Pin 1 = RESET, Pin 2 = GND, Pin 3 = VDD
	V	Pin 1 = RESET, Pin 2 = VDD, Pin 3 = GND
Package Option	DBZ	SOT23-3 pin
	DCK	SC70-3 pin
	DPW	X2SON-5 pin
Reel	R	Large reel

## 12.2 Documentation Support

### 12.2.1 Related Documentation

For related documentation see the following:

- Texas Instruments, [TLV803EA29EVM User Guide](#)
- Texas Instruments, [Voltage Supervisors \(Reset ICs\): Frequently Asked Questions \(FAQs\)](#)

### 12.3 接收文档更新通知

要接收文档更新通知，请导航至 [ti.com](https://www.ti.com) 上的器件产品文件夹。点击 [订阅更新](#) 进行注册，即可每周接收产品信息更改摘要。有关更改的详细信息，请查看任何已修订文档中包含的修订历史记录。

### 12.4 支持资源

TI E2E™ 支持论坛是工程师的重要参考资料，可直接从专家获得快速、经过验证的解答和设计帮助。搜索现有解答或提出自己的问题可获得所需的快速设计帮助。

链接的内容由各个贡献者“按原样”提供。这些内容并不构成 TI 技术规范，并且不一定反映 TI 的观点；请参阅 TI 的《[使用条款](#)》。

### 12.5 Trademarks

TI E2E™ is a trademark of Texas Instruments.

所有商标均为其各自所有者的财产。

### 12.6 Electrostatic Discharge Caution



This integrated circuit can be damaged by ESD. Texas Instruments recommends that all integrated circuits be handled with appropriate precautions. Failure to observe proper handling and installation procedures can cause damage.

ESD damage can range from subtle performance degradation to complete device failure. Precision integrated circuits may be more susceptible to damage because very small parametric changes could cause the device not to meet its published specifications.

### 12.7 术语表

[TI 术语表](#) 本术语表列出并解释了术语、首字母缩略词和定义。

## 13 Mechanical, Packaging, and Orderable Information

The following pages include mechanical, packaging, and orderable information. This information is the most current data available for the designated devices. This data is subject to change without notice and revision of this document. For browser-based versions of this data sheet, refer to the left-hand navigation.

## 重要声明和免责声明

TI 提供技术和可靠性数据 (包括数据表)、设计资源 (包括参考设计)、应用或其他设计建议、网络工具、安全信息和其他资源, 不保证没有瑕疵且不做任何明示或暗示的担保, 包括但不限于对适销性、某特定用途方面的适用性或不侵犯任何第三方知识产权的暗示担保。

这些资源可供使用 TI 产品进行设计的熟练开发人员使用。您将自行承担以下全部责任: (1) 针对您的应用选择合适的 TI 产品, (2) 设计、验证并测试您的应用, (3) 确保您的应用满足相应标准以及任何其他安全、安保或其他要求。这些资源如有变更, 恕不另行通知。TI 授权您仅可将这些资源用于研发本资源所述的 TI 产品的应用。严禁对这些资源进行其他复制或展示。您无权使用任何其他 TI 知识产权或任何第三方知识产权。您应全额赔偿因在这些资源的使用中对 TI 及其代表造成的任何索赔、损害、成本、损失和债务, TI 对此概不负责。

TI 提供的产品受 TI 的销售条款 (<https://www.ti.com/legal/termsofsale.html>) 或 [ti.com](https://www.ti.com) 上其他适用条款/TI 产品随附的其他适用条款的约束。TI 提供这些资源并不会扩展或以其他方式更改 TI 针对 TI 产品发布的适用的担保或担保免责声明。

邮寄地址: Texas Instruments, Post Office Box 655303, Dallas, Texas 75265

Copyright © 2021, 德州仪器 (TI) 公司

**PACKAGING INFORMATION**

Orderable Device	Status (1)	Package Type	Package Drawing	Pins	Package Qty	Eco Plan (2)	Lead finish/ Ball material (6)	MSL Peak Temp (3)	Op Temp (°C)	Device Marking (4/5)	Samples
TLV803EA17DPWR	ACTIVE	X2SON	DPW	5	3000	RoHS & Green	NIPDAU	Level-2-260C-1 YEAR	-40 to 125	IT	<a href="#">Samples</a>
TLV803EA18DPWR	ACTIVE	X2SON	DPW	5	3000	RoHS & Green	NIPDAU	Level-2-260C-1 YEAR	-40 to 125	IV	<a href="#">Samples</a>
TLV803EA22DBZR	ACTIVE	SOT-23	DBZ	3	3000	RoHS & Green	NIPDAU   SN	Level-1-260C-UNLIM	-40 to 125	322A	<a href="#">Samples</a>
TLV803EA22DCKR	ACTIVE	SC70	DCK	3	3000	RoHS & Green	NIPDAU	Level-2-260C-1 YEAR	-40 to 125	3FA	<a href="#">Samples</a>
TLV803EA24DCKR	ACTIVE	SC70	DCK	3	3000	RoHS & Green	NIPDAU	Level-2-260C-1 YEAR	-40 to 125	34A	<a href="#">Samples</a>
TLV803EA26DBZR	ACTIVE	SOT-23	DBZ	3	3000	RoHS & Green	NIPDAU   SN	Level-1-260C-UNLIM	-40 to 125	326A	<a href="#">Samples</a>
TLV803EA26DCKR	ACTIVE	SC70	DCK	3	3000	RoHS & Green	NIPDAU	Level-2-260C-1 YEAR	-40 to 125	32A	<a href="#">Samples</a>
TLV803EA26DPWR	ACTIVE	X2SON	DPW	5	3000	RoHS & Green	NIPDAU	Level-2-260C-1 YEAR	-40 to 125	IW	<a href="#">Samples</a>
TLV803EA26RDBZR	ACTIVE	SOT-23	DBZ	3	3000	RoHS & Green	SN	Level-1-260C-UNLIM	-40 to 125	36AR	<a href="#">Samples</a>
TLV803EA29DBZR	ACTIVE	SOT-23	DBZ	3	3000	RoHS & Green	NIPDAU   SN	Level-1-260C-UNLIM	-40 to 125	329A	<a href="#">Samples</a>
TLV803EA29DCKR	ACTIVE	SC70	DCK	3	3000	RoHS & Green	NIPDAU	Level-1-260C-UNLIM	-40 to 125	39A	<a href="#">Samples</a>
TLV803EA29DPWR	ACTIVE	X2SON	DPW	5	3000	RoHS & Green	NIPDAU	Level-2-260C-1 YEAR	-40 to 125	IX	<a href="#">Samples</a>
TLV803EA29RDBZR	ACTIVE	SOT-23	DBZ	3	3000	RoHS & Green	NIPDAU   SN	Level-1-260C-UNLIM	-40 to 125	39AR	<a href="#">Samples</a>
TLV803EA29VDBZR	ACTIVE	SOT-23	DBZ	3	3000	RoHS & Green	SN	Level-1-260C-UNLIM	-40 to 125	39AV	<a href="#">Samples</a>
TLV803EA30DBZR	ACTIVE	SOT-23	DBZ	3	3000	RoHS & Green	SN	Level-1-260C-UNLIM	-40 to 125	330A	<a href="#">Samples</a>
TLV803EA30DCKR	ACTIVE	SC70	DCK	3	3000	RoHS & Green	NIPDAU	Level-2-260C-1 YEAR	-40 to 125	30A	<a href="#">Samples</a>
TLV803EA42RDBZR	ACTIVE	SOT-23	DBZ	3	3000	RoHS & Green	SN	Level-1-260C-UNLIM	-40 to 125	3DAR	<a href="#">Samples</a>
TLV803EA43DBZR	ACTIVE	SOT-23	DBZ	3	3000	RoHS & Green	SN	Level-1-260C-UNLIM	-40 to 125	343A	<a href="#">Samples</a>
TLV803EA43DCKR	ACTIVE	SC70	DCK	3	3000	RoHS & Green	NIPDAU	Level-2-260C-1 YEAR	-40 to 125	33A	<a href="#">Samples</a>
TLV803EA43RDBZR	ACTIVE	SOT-23	DBZ	3	3000	RoHS & Green	SN	Level-1-260C-UNLIM	-40 to 125	34AR	<a href="#">Samples</a>

Orderable Device	Status (1)	Package Type	Package Drawing	Pins	Package Qty	Eco Plan (2)	Lead finish/ Ball material (6)	MSL Peak Temp (3)	Op Temp (°C)	Device Marking (4/5)	Samples
TLV803EA43VDBZR	ACTIVE	SOT-23	DBZ	3	3000	RoHS & Green	SN	Level-1-260C-UNLIM	-40 to 125	34AV	<a href="#">Samples</a>
TLV803EB22DCKR	ACTIVE	SC70	DCK	3	3000	RoHS & Green	NIPDAU	Level-2-260C-1 YEAR	-40 to 125	32B	<a href="#">Samples</a>
TLV803EB26RDBZR	ACTIVE	SOT-23	DBZ	3	3000	RoHS & Green	SN	Level-1-260C-UNLIM	-40 to 125	36BR	<a href="#">Samples</a>
TLV803EB29DBZR	ACTIVE	SOT-23	DBZ	3	3000	RoHS & Green	NIPDAU   SN	Level-1-260C-UNLIM	-40 to 125	329B	<a href="#">Samples</a>
TLV803EB29RDBZR	ACTIVE	SOT-23	DBZ	3	3000	RoHS & Green	SN	Level-1-260C-UNLIM	-40 to 125	39BR	<a href="#">Samples</a>
TLV803EB33VDBZR	ACTIVE	SOT-23	DBZ	3	3000	RoHS & Green	NIPDAU   SN	Level-1-260C-UNLIM	-40 to 125	3CBV	<a href="#">Samples</a>
TLV803EB42VDBZR	ACTIVE	SOT-23	DBZ	3	3000	RoHS & Green	NIPDAU   SN	Level-1-260C-UNLIM	-40 to 125	3DBV	<a href="#">Samples</a>
TLV803EB46DCKR	ACTIVE	SC70	DCK	3	3000	RoHS & Green	NIPDAU	Level-2-260C-1 YEAR	-40 to 125	36B	<a href="#">Samples</a>
TLV803EC29DBZR	ACTIVE	SOT-23	DBZ	3	3000	RoHS & Green	SN	Level-1-260C-UNLIM	-40 to 125	329C	<a href="#">Samples</a>
TLV803EC29DCKR	ACTIVE	SC70	DCK	3	3000	RoHS & Green	NIPDAU	Level-2-260C-1 YEAR	-40 to 125	39C	<a href="#">Samples</a>
TLV803EC30DBZR	ACTIVE	SOT-23	DBZ	3	3000	RoHS & Green	SN	Level-1-260C-UNLIM	-40 to 125	330C	<a href="#">Samples</a>
TLV803EC43DBZR	ACTIVE	SOT-23	DBZ	3	3000	RoHS & Green	SN	Level-1-260C-UNLIM	-40 to 125	343C	<a href="#">Samples</a>
TLV803ED17DPWR	ACTIVE	X2SON	DPW	5	3000	RoHS & Green	NIPDAU	Level-2-260C-1 YEAR	-40 to 125	IS	<a href="#">Samples</a>
TLV803ED18DPWR	ACTIVE	X2SON	DPW	5	3000	RoHS & Green	NIPDAU	Level-2-260C-1 YEAR	-40 to 125	IU	<a href="#">Samples</a>
TLV803ED29DBZR	ACTIVE	SOT-23	DBZ	3	3000	RoHS & Green	SN	Level-1-260C-UNLIM	-40 to 125	329D	<a href="#">Samples</a>
TLV803EF26DBZR	ACTIVE	SOT-23	DBZ	3	3000	RoHS & Green	SN	Level-1-260C-UNLIM	-40 to 125	326F	<a href="#">Samples</a>
TLV803EF29DBZR	ACTIVE	SOT-23	DBZ	3	3000	RoHS & Green	SN	Level-1-260C-UNLIM	-40 to 125	329F	<a href="#">Samples</a>
TLV809EA17DBZR	ACTIVE	SOT-23	DBZ	3	3000	RoHS & Green	SN	Level-1-260C-UNLIM	-40 to 125	917A	<a href="#">Samples</a>
TLV809EA22DBZR	ACTIVE	SOT-23	DBZ	3	3000	RoHS & Green	SN	Level-1-260C-UNLIM	-40 to 125	922A	<a href="#">Samples</a>
TLV809EA26DBZR	ACTIVE	SOT-23	DBZ	3	3000	RoHS & Green	NIPDAU   SN	Level-1-260C-UNLIM	-40 to 125	926A	<a href="#">Samples</a>
TLV809EA26DCKR	ACTIVE	SC70	DCK	3	3000	RoHS & Green	NIPDAU	Level-2-260C-1 YEAR	-40 to 125	92A	<a href="#">Samples</a>

Orderable Device	Status (1)	Package Type	Package Drawing	Pins	Package Qty	Eco Plan (2)	Lead finish/ Ball material (6)	MSL Peak Temp (3)	Op Temp (°C)	Device Marking (4/5)	Samples
TLV809EA26DPWR	ACTIVE	X2SON	DPW	5	3000	RoHS & Green	NIPDAU	Level-2-260C-1 YEAR	-40 to 125	IZ	<a href="#">Samples</a>
TLV809EA29DBZR	ACTIVE	SOT-23	DBZ	3	3000	RoHS & Green	NIPDAU   SN	Level-1-260C-UNLIM	-40 to 125	929A	<a href="#">Samples</a>
TLV809EA29DCKR	ACTIVE	SC70	DCK	3	3000	RoHS & Green	NIPDAU	Level-2-260C-1 YEAR	-40 to 125	99A	<a href="#">Samples</a>
TLV809EA29DPWR	ACTIVE	X2SON	DPW	5	3000	RoHS & Green	NIPDAU	Level-2-260C-1 YEAR	-40 to 125	J1	<a href="#">Samples</a>
TLV809EA30DBZR	ACTIVE	SOT-23	DBZ	3	3000	RoHS & Green	SN	Level-1-260C-UNLIM	-40 to 125	930A	<a href="#">Samples</a>
TLV809EA30DCKR	ACTIVE	SC70	DCK	3	3000	RoHS & Green	NIPDAU	Level-2-260C-1 YEAR	-40 to 125	90A	<a href="#">Samples</a>
TLV809EA43DBZR	ACTIVE	SOT-23	DBZ	3	3000	RoHS & Green	SN	Level-1-260C-UNLIM	-40 to 125	943A	<a href="#">Samples</a>
TLV809EA45DBZR	ACTIVE	SOT-23	DBZ	3	3000	RoHS & Green	SN	Level-1-260C-UNLIM	-40 to 125	945A	<a href="#">Samples</a>
TLV809EA45DCKR	ACTIVE	SC70	DCK	3	3000	RoHS & Green	NIPDAU	Level-2-260C-1 YEAR	-40 to 125	95A	<a href="#">Samples</a>
TLV809EA46DBZR	ACTIVE	SOT-23	DBZ	3	3000	RoHS & Green	SN	Level-1-260C-UNLIM	-40 to 125	946A	<a href="#">Samples</a>
TLV809EA46DCKR	ACTIVE	SC70	DCK	3	3000	RoHS & Green	NIPDAU	Level-2-260C-1 YEAR	-40 to 125	96A	<a href="#">Samples</a>
TLV809EA46DPWR	ACTIVE	X2SON	DPW	5	3000	RoHS & Green	NIPDAU	Level-2-260C-1 YEAR	-40 to 125	J2	<a href="#">Samples</a>
TLV809EC26DBZR	ACTIVE	SOT-23	DBZ	3	3000	RoHS & Green	SN	Level-1-260C-UNLIM	-40 to 125	926C	<a href="#">Samples</a>
TLV809EC46DBZR	ACTIVE	SOT-23	DBZ	3	3000	RoHS & Green	SN	Level-1-260C-UNLIM	-40 to 125	946C	<a href="#">Samples</a>
TLV809ED29DBZR	ACTIVE	SOT-23	DBZ	3	3000	RoHS & Green	SN	Level-1-260C-UNLIM	-40 to 125	929D	<a href="#">Samples</a>
TLV809EF30DBZR	ACTIVE	SOT-23	DBZ	3	3000	RoHS & Green	SN	Level-1-260C-UNLIM	-40 to 125	930F	<a href="#">Samples</a>
TLV810EA29DBZR	ACTIVE	SOT-23	DBZ	3	3000	RoHS & Green	SN	Level-1-260C-UNLIM	-40 to 125	029A	<a href="#">Samples</a>
TLV810EA29DPWR	ACTIVE	X2SON	DPW	5	3000	RoHS & Green	NIPDAU	Level-2-260C-1 YEAR	-40 to 125	J3	<a href="#">Samples</a>

(1) The marketing status values are defined as follows:

**ACTIVE:** Product device recommended for new designs.

**LIFEBUY:** TI has announced that the device will be discontinued, and a lifetime-buy period is in effect.

**NRND:** Not recommended for new designs. Device is in production to support existing customers, but TI does not recommend using this part in a new design.

**PREVIEW:** Device has been announced but is not in production. Samples may or may not be available.

**OBSOLETE:** TI has discontinued the production of the device.

(2) **RoHS:** TI defines "RoHS" to mean semiconductor products that are compliant with the current EU RoHS requirements for all 10 RoHS substances, including the requirement that RoHS substance do not exceed 0.1% by weight in homogeneous materials. Where designed to be soldered at high temperatures, "RoHS" products are suitable for use in specified lead-free processes. TI may reference these types of products as "Pb-Free".

**RoHS Exempt:** TI defines "RoHS Exempt" to mean products that contain lead but are compliant with EU RoHS pursuant to a specific EU RoHS exemption.

**Green:** TI defines "Green" to mean the content of Chlorine (Cl) and Bromine (Br) based flame retardants meet JS709B low halogen requirements of  $\leq 1000$ ppm threshold. Antimony trioxide based flame retardants must also meet the  $\leq 1000$ ppm threshold requirement.

(3) MSL, Peak Temp. - The Moisture Sensitivity Level rating according to the JEDEC industry standard classifications, and peak solder temperature.

(4) There may be additional marking, which relates to the logo, the lot trace code information, or the environmental category on the device.

(5) Multiple Device Markings will be inside parentheses. Only one Device Marking contained in parentheses and separated by a "~" will appear on a device. If a line is indented then it is a continuation of the previous line and the two combined represent the entire Device Marking for that device.

(6) Lead finish/Ball material - Orderable Devices may have multiple material finish options. Finish options are separated by a vertical ruled line. Lead finish/Ball material values may wrap to two lines if the finish value exceeds the maximum column width.

**Important Information and Disclaimer:** The information provided on this page represents TI's knowledge and belief as of the date that it is provided. TI bases its knowledge and belief on information provided by third parties, and makes no representation or warranty as to the accuracy of such information. Efforts are underway to better integrate information from third parties. TI has taken and continues to take reasonable steps to provide representative and accurate information but may not have conducted destructive testing or chemical analysis on incoming materials and chemicals. TI and TI suppliers consider certain information to be proprietary, and thus CAS numbers and other limited information may not be available for release.

In no event shall TI's liability arising out of such information exceed the total purchase price of the TI part(s) at issue in this document sold by TI to Customer on an annual basis.

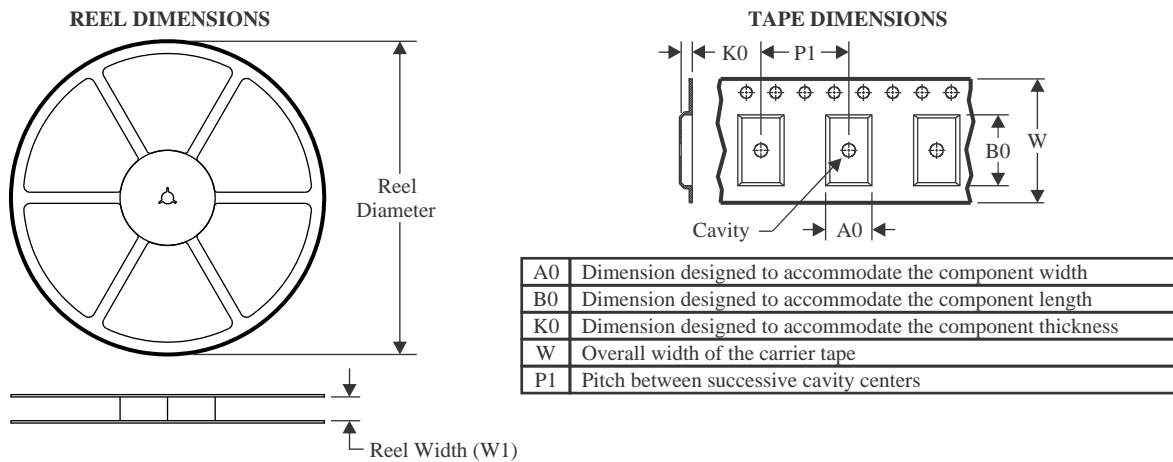
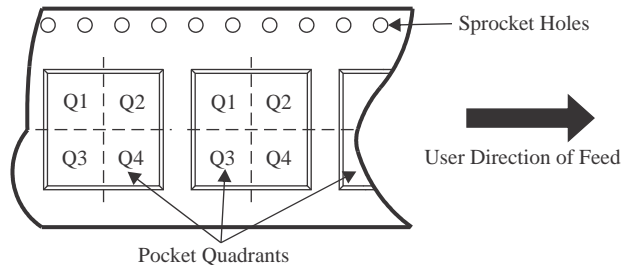

**TAPE AND REEL INFORMATION**

**QUADRANT ASSIGNMENTS FOR PIN 1 ORIENTATION IN TAPE**

\*All dimensions are nominal

Device	Package Type	Package Drawing	Pins	SPQ	Reel Diameter (mm)	Reel Width W1 (mm)	A0 (mm)	B0 (mm)	K0 (mm)	P1 (mm)	W (mm)	Pin1 Quadrant
TLV803EA17DPWR	X2SON	DPW	5	3000	178.0	8.4	0.91	0.91	0.5	2.0	8.0	Q2
TLV803EA18DPWR	X2SON	DPW	5	3000	178.0	8.4	0.91	0.91	0.5	2.0	8.0	Q2
TLV803EA22DBZR	SOT-23	DBZ	3	3000	178.0	9.0	3.15	2.77	1.22	4.0	8.0	Q3
TLV803EA22DCKR	SC70	DCK	3	3000	178.0	9.0	2.4	2.5	1.2	4.0	8.0	Q3
TLV803EA24DCKR	SC70	DCK	3	3000	178.0	9.0	2.4	2.5	1.2	4.0	8.0	Q3
TLV803EA26DBZR	SOT-23	DBZ	3	3000	178.0	9.0	3.15	2.77	1.22	4.0	8.0	Q3
TLV803EA26DBZR	SOT-23	DBZ	3	3000	180.0	8.4	2.9	3.35	1.35	4.0	8.0	Q3
TLV803EA26DCKR	SC70	DCK	3	3000	178.0	9.0	2.4	2.5	1.2	4.0	8.0	Q3
TLV803EA26DPWR	X2SON	DPW	5	3000	178.0	8.4	0.91	0.91	0.5	2.0	8.0	Q2
TLV803EA26RDBZR	SOT-23	DBZ	3	3000	178.0	9.0	3.15	2.77	1.22	4.0	8.0	Q3
TLV803EA29DBZR	SOT-23	DBZ	3	3000	178.0	9.0	3.15	2.77	1.22	4.0	8.0	Q3
TLV803EA29DBZR	SOT-23	DBZ	3	3000	180.0	8.4	2.9	3.35	1.35	4.0	8.0	Q3
TLV803EA29DCKR	SC70	DCK	3	3000	178.0	9.0	2.4	2.5	1.2	4.0	8.0	Q3
TLV803EA29DPWR	X2SON	DPW	5	3000	178.0	8.4	0.91	0.91	0.5	2.0	8.0	Q2
TLV803EA29RDBZR	SOT-23	DBZ	3	3000	180.0	8.4	2.9	3.35	1.35	4.0	8.0	Q3
TLV803EA29VDBZR	SOT-23	DBZ	3	3000	178.0	9.0	3.15	2.77	1.22	4.0	8.0	Q3

Device	Package Type	Package Drawing	Pins	SPQ	Reel Diameter (mm)	Reel Width W1 (mm)	A0 (mm)	B0 (mm)	K0 (mm)	P1 (mm)	W (mm)	Pin1 Quadrant
TLV803EA30DBZR	SOT-23	DBZ	3	3000	178.0	9.0	3.15	2.77	1.22	4.0	8.0	Q3
TLV803EA30DCKR	SC70	DCK	3	3000	178.0	9.0	2.4	2.5	1.2	4.0	8.0	Q3
TLV803EA42RDBZR	SOT-23	DBZ	3	3000	178.0	9.0	3.15	2.77	1.22	4.0	8.0	Q3
TLV803EA43DBZR	SOT-23	DBZ	3	3000	178.0	9.0	3.15	2.77	1.22	4.0	8.0	Q3
TLV803EA43DCKR	SC70	DCK	3	3000	178.0	9.0	2.4	2.5	1.2	4.0	8.0	Q3
TLV803EA43RDBZR	SOT-23	DBZ	3	3000	178.0	9.0	3.15	2.77	1.22	4.0	8.0	Q3
TLV803EA43VDBZR	SOT-23	DBZ	3	3000	178.0	9.0	3.15	2.77	1.22	4.0	8.0	Q3
TLV803EB22DCKR	SC70	DCK	3	3000	178.0	9.0	2.4	2.5	1.2	4.0	8.0	Q3
TLV803EB26RDBZR	SOT-23	DBZ	3	3000	178.0	9.0	3.15	2.77	1.22	4.0	8.0	Q3
TLV803EB29DBZR	SOT-23	DBZ	3	3000	178.0	9.0	3.15	2.77	1.22	4.0	8.0	Q3
TLV803EB29DBZR	SOT-23	DBZ	3	3000	180.0	8.4	2.9	3.35	1.35	4.0	8.0	Q3
TLV803EB29RDBZR	SOT-23	DBZ	3	3000	178.0	9.0	3.15	2.77	1.22	4.0	8.0	Q3
TLV803EB33VDBZR	SOT-23	DBZ	3	3000	178.0	9.0	3.15	2.77	1.22	4.0	8.0	Q3
TLV803EB33VDBZR	SOT-23	DBZ	3	3000	180.0	8.4	2.9	3.35	1.35	4.0	8.0	Q3
TLV803EB42VDBZR	SOT-23	DBZ	3	3000	178.0	9.0	3.15	2.77	1.22	4.0	8.0	Q3
TLV803EB42VDBZR	SOT-23	DBZ	3	3000	180.0	8.4	2.9	3.35	1.35	4.0	8.0	Q3
TLV803EB46DCKR	SC70	DCK	3	3000	178.0	9.0	2.4	2.5	1.2	4.0	8.0	Q3
TLV803EC29DBZR	SOT-23	DBZ	3	3000	178.0	9.0	3.15	2.77	1.22	4.0	8.0	Q3
TLV803EC29DCKR	SC70	DCK	3	3000	178.0	9.0	2.4	2.5	1.2	4.0	8.0	Q3
TLV803EC30DBZR	SOT-23	DBZ	3	3000	178.0	9.0	3.15	2.77	1.22	4.0	8.0	Q3
TLV803EC43DBZR	SOT-23	DBZ	3	3000	178.0	9.0	3.15	2.77	1.22	4.0	8.0	Q3
TLV803ED17DPWR	X2SON	DPW	5	3000	178.0	8.4	0.91	0.91	0.5	2.0	8.0	Q2
TLV803ED18DPWR	X2SON	DPW	5	3000	178.0	8.4	0.91	0.91	0.5	2.0	8.0	Q2
TLV803ED29DBZR	SOT-23	DBZ	3	3000	178.0	9.0	3.15	2.77	1.22	4.0	8.0	Q3
TLV803EF26DBZR	SOT-23	DBZ	3	3000	178.0	9.0	3.15	2.77	1.22	4.0	8.0	Q3
TLV803EF29DBZR	SOT-23	DBZ	3	3000	178.0	9.0	3.15	2.77	1.22	4.0	8.0	Q3
TLV809EA17DBZR	SOT-23	DBZ	3	3000	178.0	9.0	3.15	2.77	1.22	4.0	8.0	Q3
TLV809EA22DBZR	SOT-23	DBZ	3	3000	178.0	9.0	3.15	2.77	1.22	4.0	8.0	Q3
TLV809EA26DBZR	SOT-23	DBZ	3	3000	180.0	8.4	2.9	3.35	1.35	4.0	8.0	Q3
TLV809EA26DCKR	SC70	DCK	3	3000	178.0	9.0	2.4	2.5	1.2	4.0	8.0	Q3
TLV809EA26DPWR	X2SON	DPW	5	3000	178.0	8.4	0.91	0.91	0.5	2.0	8.0	Q2
TLV809EA29DBZR	SOT-23	DBZ	3	3000	178.0	9.0	3.15	2.77	1.22	4.0	8.0	Q3
TLV809EA29DBZR	SOT-23	DBZ	3	3000	180.0	8.4	2.9	3.35	1.35	4.0	8.0	Q3
TLV809EA29DCKR	SC70	DCK	3	3000	178.0	9.0	2.4	2.5	1.2	4.0	8.0	Q3
TLV809EA29DPWR	X2SON	DPW	5	3000	178.0	8.4	0.91	0.91	0.5	2.0	8.0	Q2
TLV809EA30DBZR	SOT-23	DBZ	3	3000	178.0	9.0	3.15	2.77	1.22	4.0	8.0	Q3
TLV809EA30DCKR	SC70	DCK	3	3000	178.0	9.0	2.4	2.5	1.2	4.0	8.0	Q3
TLV809EA43DBZR	SOT-23	DBZ	3	3000	178.0	9.0	3.15	2.77	1.22	4.0	8.0	Q3
TLV809EA45DBZR	SOT-23	DBZ	3	3000	178.0	9.0	3.15	2.77	1.22	4.0	8.0	Q3
TLV809EA45DCKR	SC70	DCK	3	3000	178.0	9.0	2.4	2.5	1.2	4.0	8.0	Q3
TLV809EA46DBZR	SOT-23	DBZ	3	3000	178.0	9.0	3.15	2.77	1.22	4.0	8.0	Q3

Device	Package Type	Package Drawing	Pins	SPQ	Reel Diameter (mm)	Reel Width W1 (mm)	A0 (mm)	B0 (mm)	K0 (mm)	P1 (mm)	W (mm)	Pin1 Quadrant
TLV809EA46DCKR	SC70	DCK	3	3000	178.0	9.0	2.4	2.5	1.2	4.0	8.0	Q3
TLV809EA46DPWR	X2SON	DPW	5	3000	178.0	8.4	0.91	0.91	0.5	2.0	8.0	Q2
TLV809EC26DBZR	SOT-23	DBZ	3	3000	178.0	9.0	3.15	2.77	1.22	4.0	8.0	Q3
TLV809EC46DBZR	SOT-23	DBZ	3	3000	178.0	9.0	3.15	2.77	1.22	4.0	8.0	Q3
TLV809ED29DBZR	SOT-23	DBZ	3	3000	178.0	9.0	3.15	2.77	1.22	4.0	8.0	Q3
TLV809EF30DBZR	SOT-23	DBZ	3	3000	178.0	9.0	3.15	2.77	1.22	4.0	8.0	Q3
TLV810EA29DBZR	SOT-23	DBZ	3	3000	178.0	9.0	3.15	2.77	1.22	4.0	8.0	Q3
TLV810EA29DPWR	X2SON	DPW	5	3000	178.0	8.4	0.91	0.91	0.5	2.0	8.0	Q2

**TAPE AND REEL BOX DIMENSIONS**

\*All dimensions are nominal

Device	Package Type	Package Drawing	Pins	SPQ	Length (mm)	Width (mm)	Height (mm)
TLV803EA17DPWR	X2SON	DPW	5	3000	205.0	200.0	33.0
TLV803EA18DPWR	X2SON	DPW	5	3000	205.0	200.0	33.0
TLV803EA22DBZR	SOT-23	DBZ	3	3000	180.0	180.0	18.0
TLV803EA22DCKR	SC70	DCK	3	3000	180.0	180.0	18.0
TLV803EA24DCKR	SC70	DCK	3	3000	180.0	180.0	18.0
TLV803EA26DBZR	SOT-23	DBZ	3	3000	180.0	180.0	18.0
TLV803EA26DBZR	SOT-23	DBZ	3	3000	210.0	185.0	35.0
TLV803EA26DCKR	SC70	DCK	3	3000	180.0	180.0	18.0
TLV803EA26DPWR	X2SON	DPW	5	3000	205.0	200.0	33.0
TLV803EA26RDBZR	SOT-23	DBZ	3	3000	180.0	180.0	18.0
TLV803EA29DBZR	SOT-23	DBZ	3	3000	180.0	180.0	18.0
TLV803EA29DBZR	SOT-23	DBZ	3	3000	210.0	185.0	35.0
TLV803EA29DCKR	SC70	DCK	3	3000	180.0	180.0	18.0
TLV803EA29DPWR	X2SON	DPW	5	3000	205.0	200.0	33.0
TLV803EA29RDBZR	SOT-23	DBZ	3	3000	210.0	185.0	35.0
TLV803EA29VDBZR	SOT-23	DBZ	3	3000	180.0	180.0	18.0
TLV803EA30DBZR	SOT-23	DBZ	3	3000	180.0	180.0	18.0
TLV803EA30DCKR	SC70	DCK	3	3000	180.0	180.0	18.0

Device	Package Type	Package Drawing	Pins	SPQ	Length (mm)	Width (mm)	Height (mm)
TLV803EA42RDBZR	SOT-23	DBZ	3	3000	180.0	180.0	18.0
TLV803EA43DBZR	SOT-23	DBZ	3	3000	180.0	180.0	18.0
TLV803EA43DCKR	SC70	DCK	3	3000	180.0	180.0	18.0
TLV803EA43RDBZR	SOT-23	DBZ	3	3000	180.0	180.0	18.0
TLV803EA43VDBZR	SOT-23	DBZ	3	3000	180.0	180.0	18.0
TLV803EB22DCKR	SC70	DCK	3	3000	180.0	180.0	18.0
TLV803EB26RDBZR	SOT-23	DBZ	3	3000	180.0	180.0	18.0
TLV803EB29DBZR	SOT-23	DBZ	3	3000	180.0	180.0	18.0
TLV803EB29DBZR	SOT-23	DBZ	3	3000	210.0	185.0	35.0
TLV803EB29RDBZR	SOT-23	DBZ	3	3000	180.0	180.0	18.0
TLV803EB33VDBZR	SOT-23	DBZ	3	3000	180.0	180.0	18.0
TLV803EB33VDBZR	SOT-23	DBZ	3	3000	210.0	185.0	35.0
TLV803EB42VDBZR	SOT-23	DBZ	3	3000	180.0	180.0	18.0
TLV803EB42VDBZR	SOT-23	DBZ	3	3000	210.0	185.0	35.0
TLV803EB46DCKR	SC70	DCK	3	3000	180.0	180.0	18.0
TLV803EC29DBZR	SOT-23	DBZ	3	3000	180.0	180.0	18.0
TLV803EC29DCKR	SC70	DCK	3	3000	180.0	180.0	18.0
TLV803EC30DBZR	SOT-23	DBZ	3	3000	180.0	180.0	18.0
TLV803EC43DBZR	SOT-23	DBZ	3	3000	180.0	180.0	18.0
TLV803ED17DPWR	X2SON	DPW	5	3000	205.0	200.0	33.0
TLV803ED18DPWR	X2SON	DPW	5	3000	205.0	200.0	33.0
TLV803ED29DBZR	SOT-23	DBZ	3	3000	180.0	180.0	18.0
TLV803EF26DBZR	SOT-23	DBZ	3	3000	180.0	180.0	18.0
TLV803EF29DBZR	SOT-23	DBZ	3	3000	180.0	180.0	18.0
TLV809EA17DBZR	SOT-23	DBZ	3	3000	180.0	180.0	18.0
TLV809EA22DBZR	SOT-23	DBZ	3	3000	180.0	180.0	18.0
TLV809EA26DBZR	SOT-23	DBZ	3	3000	210.0	185.0	35.0
TLV809EA26DCKR	SC70	DCK	3	3000	180.0	180.0	18.0
TLV809EA26DPWR	X2SON	DPW	5	3000	205.0	200.0	33.0
TLV809EA29DBZR	SOT-23	DBZ	3	3000	180.0	180.0	18.0
TLV809EA29DBZR	SOT-23	DBZ	3	3000	210.0	185.0	35.0
TLV809EA29DCKR	SC70	DCK	3	3000	180.0	180.0	18.0
TLV809EA29DPWR	X2SON	DPW	5	3000	205.0	200.0	33.0
TLV809EA30DBZR	SOT-23	DBZ	3	3000	180.0	180.0	18.0
TLV809EA30DCKR	SC70	DCK	3	3000	180.0	180.0	18.0
TLV809EA43DBZR	SOT-23	DBZ	3	3000	180.0	180.0	18.0
TLV809EA45DBZR	SOT-23	DBZ	3	3000	180.0	180.0	18.0
TLV809EA45DCKR	SC70	DCK	3	3000	180.0	180.0	18.0
TLV809EA46DBZR	SOT-23	DBZ	3	3000	180.0	180.0	18.0
TLV809EA46DCKR	SC70	DCK	3	3000	180.0	180.0	18.0
TLV809EA46DPWR	X2SON	DPW	5	3000	205.0	200.0	33.0
TLV809EC26DBZR	SOT-23	DBZ	3	3000	180.0	180.0	18.0
TLV809EC46DBZR	SOT-23	DBZ	3	3000	180.0	180.0	18.0

---

<b>Device</b>	<b>Package Type</b>	<b>Package Drawing</b>	<b>Pins</b>	<b>SPQ</b>	<b>Length (mm)</b>	<b>Width (mm)</b>	<b>Height (mm)</b>
TLV809ED29DBZR	SOT-23	DBZ	3	3000	180.0	180.0	18.0
TLV809EF30DBZR	SOT-23	DBZ	3	3000	180.0	180.0	18.0
TLV810EA29DBZR	SOT-23	DBZ	3	3000	180.0	180.0	18.0
TLV810EA29DPWR	X2SON	DPW	5	3000	205.0	200.0	33.0

**GENERIC PACKAGE VIEW**

**DBZ 3**

**SOT-23 - 1.12 mm max height**

SMALL OUTLINE TRANSISTOR



Images above are just a representation of the package family, actual package may vary.  
Refer to the product data sheet for package details.

4203227/C

DBZ0003A



# PACKAGE OUTLINE

SOT-23 - 1.12 mm max height

SMALL OUTLINE TRANSISTOR



4214838/C 04/2017

NOTES:

1. All linear dimensions are in millimeters. Any dimensions in parenthesis are for reference only. Dimensioning and tolerancing per ASME Y14.5M.
2. This drawing is subject to change without notice.
3. Reference JEDEC registration TO-236, except minimum foot length.



# EXAMPLE BOARD LAYOUT

DBZ0003A

SOT-23 - 1.12 mm max height

SMALL OUTLINE TRANSISTOR

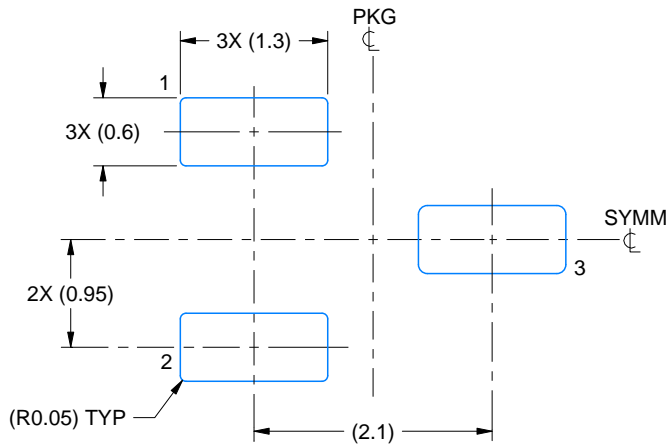

LAND PATTERN EXAMPLE  
SCALE:15X

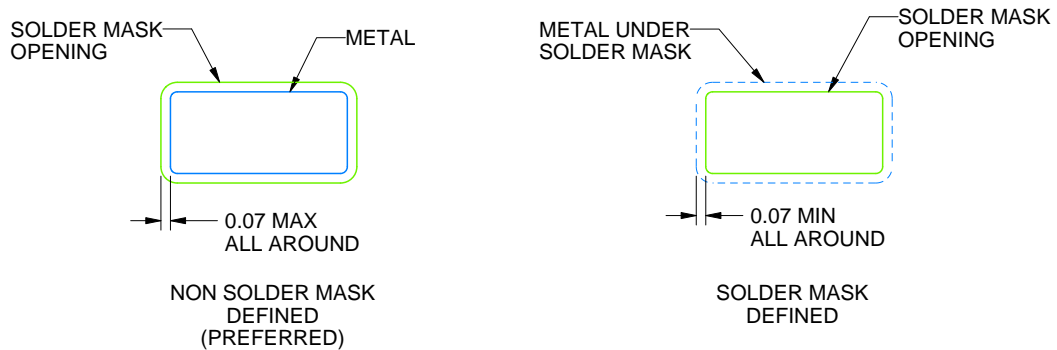

SOLDER MASK DETAILS

4214838/C 04/2017

NOTES: (continued)

- 4. Publication IPC-7351 may have alternate designs.
- 5. Solder mask tolerances between and around signal pads can vary based on board fabrication site.

# EXAMPLE STENCIL DESIGN

DBZ0003A

SOT-23 - 1.12 mm max height

SMALL OUTLINE TRANSISTOR



SOLDER PASTE EXAMPLE  
BASED ON 0.125 THICK STENCIL  
SCALE:15X

4214838/C 04/2017

NOTES: (continued)

6. Laser cutting apertures with trapezoidal walls and rounded corners may offer better paste release. IPC-7525 may have alternate design recommendations.
7. Board assembly site may have different recommendations for stencil design.

DCK0003A

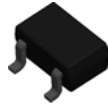

# PACKAGE OUTLINE

SOT-SC70 - 1.1 max height

SMALL OUTLINE TRANSISTOR SC70

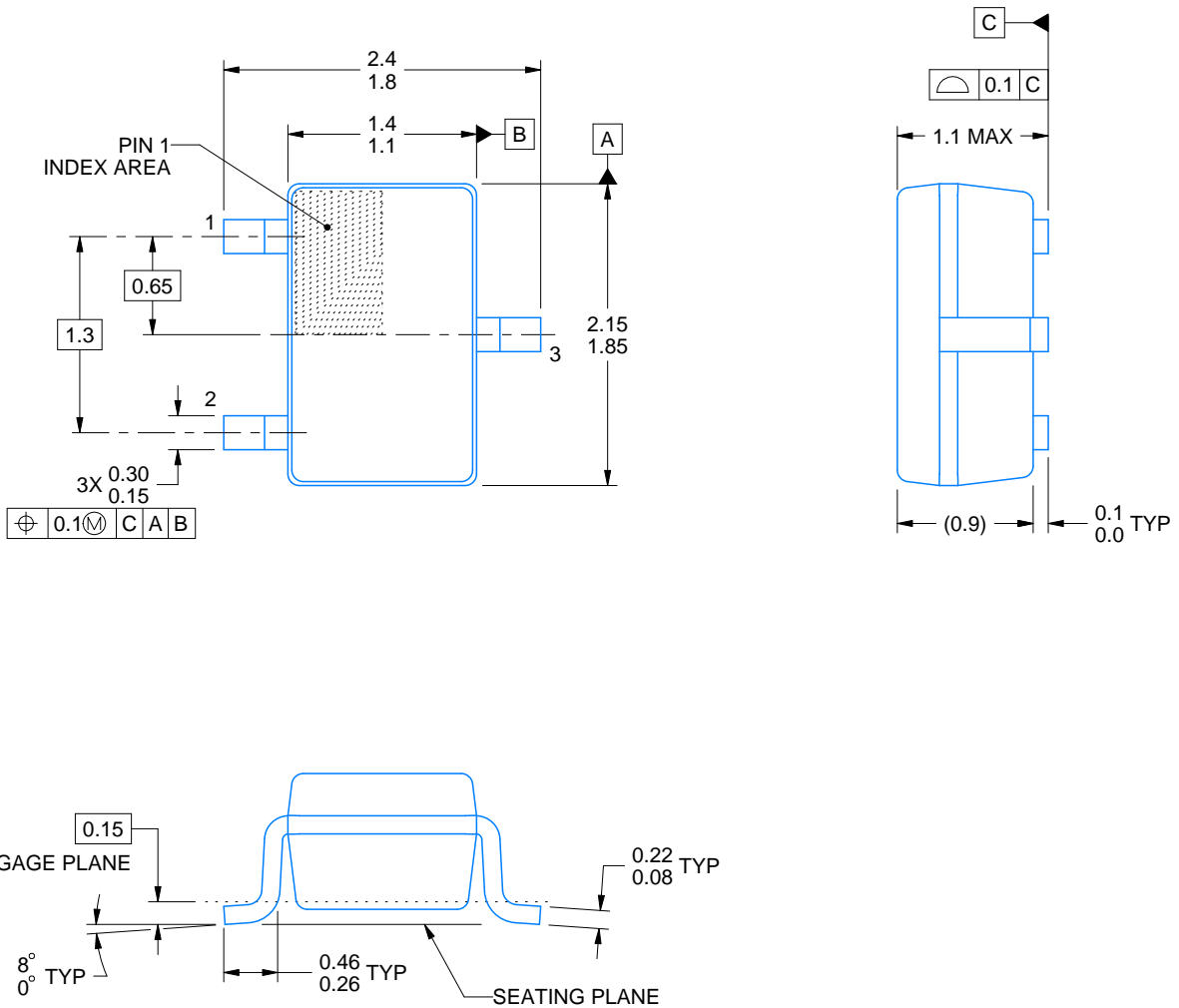

4220745/C 06/2021

NOTES:

1. All linear dimensions are in millimeters. Any dimensions in parenthesis are for reference only. Dimensioning and tolerancing per ASME Y14.5M.
2. This drawing is subject to change without notice.

# EXAMPLE BOARD LAYOUT

DCK0003A

SOT-SC70 - 1.1 max height

SMALL OUTLINE TRANSISTOR SC70

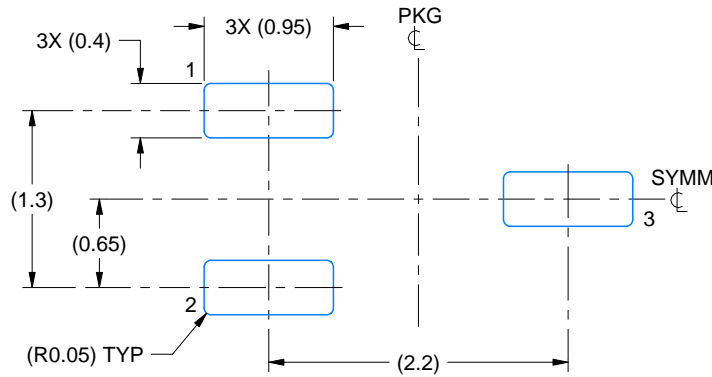

LAND PATTERN EXAMPLE  
EXPOSED METAL SHOWN  
SCALE:18X

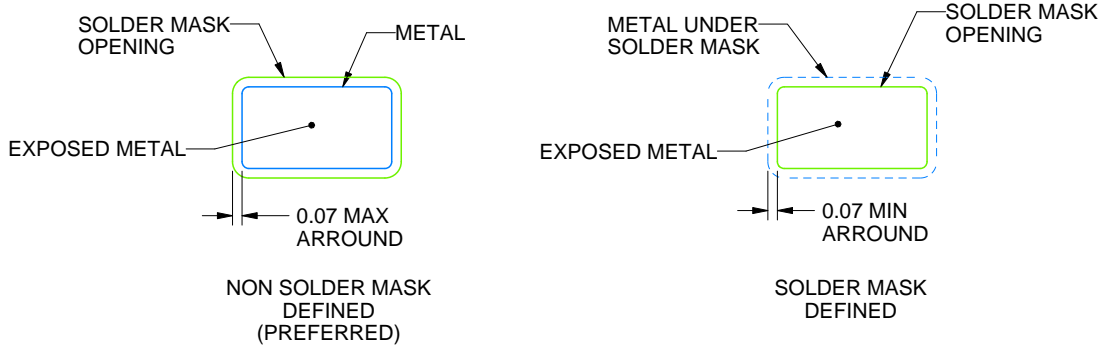

SOLDER MASK DETAILS

4220745/C 06/2021

NOTES: (continued)

- 3. Publication IPC-7351 may have alternate designs.
- 4. Solder mask tolerances between and around signal pads can vary based on board fabrication site.

# EXAMPLE STENCIL DESIGN

DCK0003A

SOT-SC70 - 1.1 max height

SMALL OUTLINE TRANSISTOR SC70

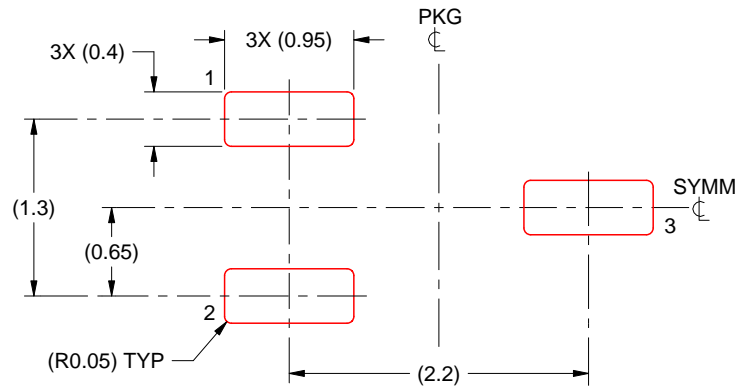

SOLDER PASTE EXAMPLE  
BASED ON 0.125 THICK STENCIL  
SCALE:18X

4220745/C 06/2021

NOTES: (continued)

5. Laser cutting apertures with trapezoidal walls and rounded corners may offer better paste release. IPC-7525 may have alternate design recommendations.
6. Board assembly site may have different recommendations for stencil design.

## GENERIC PACKAGE VIEW

DPW 5

X2SON - 0.4 mm max height

PLASTIC SMALL OUTLINE - NO LEAD



Images above are just a representation of the package family, actual package may vary.  
Refer to the product data sheet for package details.

4211218-3/D

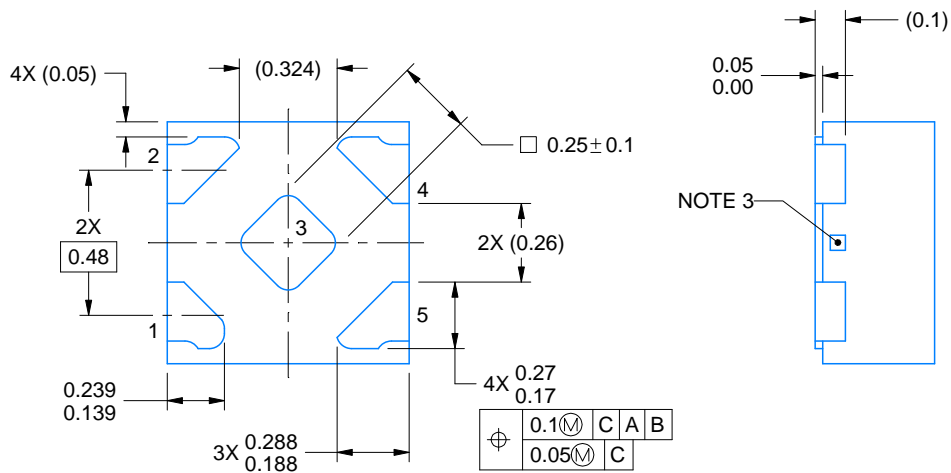

4223102/D 03/2022

NOTES:

1. All linear dimensions are in millimeters. Any dimensions in parenthesis are for reference only. Dimensioning and tolerancing per ASME Y14.5M.
2. This drawing is subject to change without notice.
3. The size and shape of this feature may vary.

# EXAMPLE BOARD LAYOUT

DPW0005A

X2SON - 0.4 mm max height

PLASTIC SMALL OUTLINE - NO LEAD

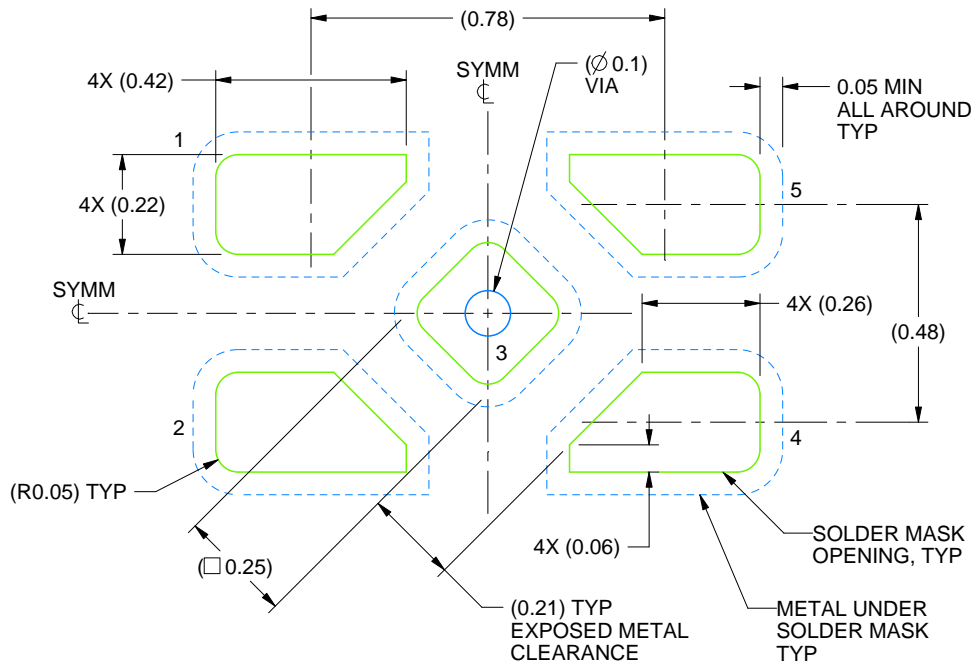

LAND PATTERN EXAMPLE  
SOLDER MASK DEFINED  
SCALE:60X

4223102/D 03/2022

NOTES: (continued)

4. This package is designed to be soldered to a thermal pad on the board. For more information, refer to QFN/SON PCB application note in literature No. SLUA271 ([www.ti.com/lit/slua271](http://www.ti.com/lit/slua271)).



# EXAMPLE STENCIL DESIGN

DPW0005A

X2SON - 0.4 mm max height

PLASTIC SMALL OUTLINE - NO LEAD



SOLDER PASTE EXAMPLE  
BASED ON 0.1 mm THICK STENCIL

EXPOSED PAD 3  
92% PRINTED SOLDER COVERAGE BY AREA UNDER PACKAGE  
SCALE:100X

4223102/D 03/2022

NOTES: (continued)

5. Laser cutting apertures with trapezoidal walls and rounded corners may offer better paste release. IPC-7525 may have alternate design recommendations.

## 重要声明和免责声明

TI“按原样”提供技术和可靠性数据（包括数据表）、设计资源（包括参考设计）、应用或其他设计建议、网络工具、安全信息和其他资源，不保证没有瑕疵且不做任何明示或暗示的担保，包括但不限于对适销性、某特定用途方面的适用性或不侵犯任何第三方知识产权的暗示担保。

这些资源可供使用 TI 产品进行设计的熟练开发人员使用。您将自行承担以下全部责任：(1) 针对您的应用选择合适的 TI 产品，(2) 设计、验证并测试您的应用，(3) 确保您的应用满足相应标准以及任何其他功能安全、信息安全、监管或其他要求。

这些资源如有变更，恕不另行通知。TI 授权您仅可将这些资源用于研发本资源所述的 TI 产品的应用。严禁对这些资源进行其他复制或展示。您无权使用任何其他 TI 知识产权或任何第三方知识产权。您应全额赔偿因在这些资源的使用中对 TI 及其代表造成的任何索赔、损害、成本、损失和债务，TI 对此概不负责。

TI 提供的产品受 [TI 的销售条款](#) 或 [ti.com](#) 上其他适用条款/TI 产品随附的其他适用条款的约束。TI 提供这些资源并不会扩展或以其他方式更改 TI 针对 TI 产品发布的适用的担保或担保免责声明。

TI 反对并拒绝您可能提出的任何其他或不同的条款。

邮寄地址：Texas Instruments, Post Office Box 655303, Dallas, Texas 75265

Copyright © 2023，德州仪器 (TI) 公司

## X-ON Electronics

Largest Supplier of Electrical and Electronic Components

*Click to view similar products for [Supervisory Circuits](#) category:*

*Click to view products by [Texas Instruments](#) manufacturer:*

Other Similar products are found below :

[CAT853STBI-T3](#) [RT9818C-27GU3](#) [DS1232L](#) [NCV302HSN45T1G](#) [STM6710FWB7F](#) [PT7M6127NLTA3EX](#) [XC6118C25AGR-G](#)  
[ISL88011IH526Z-TK](#) [ISL88013IH529Z-TK](#) [ISL88705IP846Z](#) [ISL88706IP831Z](#) [ISL88708IB844Z](#) [ISL88708IP831Z](#) [TCM811MERCTR](#)  
[X40420S14-A](#) [X40421S14-C](#) [X40430S14-A](#) [X40430S14I-A](#) [X40430S14I-B](#) [X40431S14-A](#) [X40431S14-B](#) [X40431S14-C](#) [X40431S14I-A](#)  
[X40431S14I-B](#) [X40431S14I-C](#) [X4043P-2.7](#) [X4043PI-2.7](#) [X4043S8-2.7T1](#) [X4043S8IZ-2.7](#) [X4043S8IZT1](#) [X4043S8T1](#) [X4045P](#) [X4045PI](#)  
[X4045PI-2.7](#) [X4045S8-2.7T1](#) [X4045S8IZ](#) [X4045S8T1](#) [X4163P](#) [X4163P-2.7](#) [X4163PI](#) [X4163PI-2.7](#) [X4163S8](#) [X4165P](#) [X4165P-2.7](#)  
[X4165PI](#) [X4165PI-2.7](#) [X4165S8I-2.7](#) [X4283S8I](#) [X4323S8-2.7](#) [X4323S8I-2.7](#)