

TPS22950x 5.5V、2.7A、34mΩ 可调限流负载开关

1 特性

- 输入电压范围 (V_{IN}) : 1.8 V 至 5.5V
- 输出电流限制 (I_{LIMIT}) : 0.05A - 3.5A (典型值)
- TPS22950 : 自动重试电流限制响应
- TPS22950L : 闭锁电流限制响应
- 热关断 (TSD)
- 导通电阻 (R_{ON}) :
 - $V_{IN} = 5V$ 时, $R_{ON} : 34m\Omega$ (典型值)
 - $V_{IN} = 3.3V$ 时, $R_{ON} : 41m\Omega$ (典型值)
- 慢速开通时序可限制浪涌电流 (典型值) :
 - $V_{IN} = 5V$ 时, $t_{ON} : 800\mu s$
 - $V_{IN} = 3.3V$ 时, $t_{ON} : 550\mu s$
- 常开的反向电流阻断 (TPS22950)
- 故障指示 (FLT)
- 快速输出放电 (QOD) : 150 Ω
- ON 引脚智能下拉电阻 ($R_{PD,ON}$) :
 - $ON \geq V_{IH}$ (I_{ON}) : 50nA (最大值)
 - $ON \leq V_{IL}$ ($R_{PD,ON}$) : 500k Ω (典型值)
- 低功耗 :
 - 导通状态 (I_Q) : 40 μA (典型值)
 - 关闭状态 (I_{SD}) : 0.2 μA (典型值)
- UL 2367 认证 - 文件号 E169910
 - 已通过 $I_{LIM} = 66mA$ 至 2.46A 认证

2 应用

- 个人电子产品
- 平板电脑
- 笔记本电脑
- 游戏机
- 附件

3 说明

TPS22950x 器件是一款小型单通道负载开关, 能够通过可调输出电流限制、反向电流阻断和热关断提供强大的故障保护功能。

开关导通状态由数字输入控制, 此输入可与低压控制信号直接连接。首次加电时, 此器件使用智能下拉电阻来保持 ON 引脚不悬空, 直到系统时序控制完成。引脚故意驱动为高电平 ($>V_{IH}$) 后, 便会断开智能下拉电阻, 从而防止不必要的功率损耗。

TPS22950 通过自动重试行为响应过流事件, 而 TPS22950L 使用去抖时间和闭锁行为。

TPS22950x 采用标准 WCSP 封装, 工作环境温度范围为 $-40^{\circ}C$ 至 $125^{\circ}C$ 。

器件信息

器件型号	封装	封装尺寸 (标称值)
TPS22950、 TPS22950L	WCSP (6)	1.106mm × 0.706mm

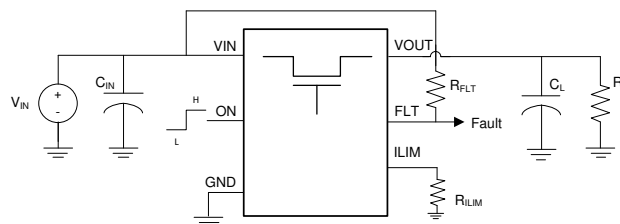

典型应用



Table of Contents

1 特性	1	9.3 Feature Description.....	12
2 应用	1	9.4 Device Functional Modes.....	15
3 说明	1	10 Application and Implementation	17
4 Revision History	2	10.1 Application Information.....	17
5 Device Comparison Table	3	10.2 Typical Application.....	17
6 Pin Configuration and Functions	4	11 Power Supply Recommendations	19
7 Specifications	5	12 Layout	20
7.1 Absolute Maximum Ratings.....	5	12.1 Layout Guidelines.....	20
7.2 ESD Ratings.....	5	12.2 Layout Example.....	20
7.3 Recommended Operating Conditions.....	5	13 Device and Documentation Support	21
7.4 Thermal Information.....	5	13.1 接收文档更新通知.....	21
7.5 Electrical Characteristics.....	6	13.2 支持资源.....	21
7.6 Switching Characteristics.....	6	13.3 Trademarks.....	21
7.7 Typical Characteristics.....	9	13.4 Electrostatic Discharge Caution.....	21
8 Parameter Measurement Information	11	13.5 术语表.....	21
9 Detailed Description	12	14 Mechanical, Packaging, and Orderable Information	22
9.1 Overview.....	12		
9.2 Functional Block Diagram.....	12		

4 Revision History

注：以前版本的页码可能与当前版本的页码不同

Changes from Revision * (December 2020) to Revision A (June 2022)	Page
• 向数据表添加了 TPS22950L 可订购信息.....	1
• Updated ESD ratings table to the latest standard.....	5
• Added line items in Electrical Characteristics to reflect TPS22950L parameters.....	5
• Updated the Overview section in Detailed Description to include device functionality	12
• Added a Current Limiting section to describe the latch off functionality of TPS22950L	14

5 Device Comparison Table

DEVICE NAME	ILIM Range	ILIM Response	Debounce Time	RCB
TPS22950	0.05 A to 3.5 A	Auto-Retry	No	Yes
TPS22950L	0.5 A to 3.5 A	Latch Off	Yes	No

6 Pin Configuration and Functions



图 6-1. TPS22950x WCSP - 6 Top View

表 6-1. Pin Functions

PIN		I/O	DESCRIPTION
NAME	NO.		
ON	A1	I	Active high switch control input. Do not leave floating.
FLT	A2	O	Open-drain output, pulled low during thermal shutdown or reverse current-conditions.
VIN	B1	I	Switch input
VOUT	B2	O	Switch output
GND	C1	—	Device ground
ILIM	C2	O	Adjusts device current limit through a resistor to ground.

7 Specifications

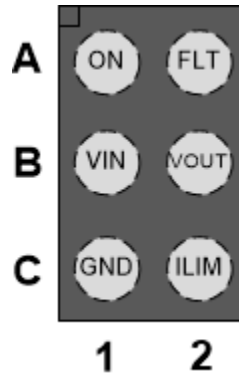
7.1 Absolute Maximum Ratings

over operating free-air temperature range (unless otherwise noted)⁽¹⁾

		MIN	MAX	UNIT
V _{IN}	Maximum Input Voltage Range	- 0.3	6	V
V _{OUT}	Maximum Output Voltage Range	- 0.3	6	V
V _{ON}	Maximum ON Pin Voltage Range	- 0.3	6	V
V _{FLT}	Maximum FLT Pin Voltage	- 0.3	6	V
I _{MAX}	Maximum Continuous Output Current		2.7	A
I _{MAX,PLS}	Maximum Pulsed Output Current (T _J = 85°C, duty cycle = 2%)		4.1	A
T _{STG}	Storage temperature	- 65	150	°C
T _{LEAD}	Maximum Lead Temperature (10 s soldering time)		300	°C

- (1) Stresses beyond those listed under *Absolute Maximum Rating* may cause permanent damage to the device. These are stress ratings only, which do not imply functional operation of the device at these or any other conditions beyond those indicated under *Recommended Operating Condition*. Exposure to absolute-maximum-rated conditions for extended periods may affect device reliability.

7.2 ESD Ratings

			VALUE	UNIT
V _(ESD)	Electrostatic discharge	Human body model (HBM), per ANSI/ESDA/ JEDEC JS-001 ⁽¹⁾	±2000	V
		Charged device model (CDM), per ANSI/ESDA/ JEDEC JS-002 ⁽²⁾	±500	

- (1) JEDEC document JEP155 states that 500-V HBM allows safe manufacturing with a standard ESD control process.
 (2) JEDEC document JEP157 states that 250-V CDM allows safe manufacturing with a standard ESD control process.

7.3 Recommended Operating Conditions

over operating free-air temperature range (unless otherwise noted)

		MIN	TYP	MAX	UNIT
V _{IN}	Input Voltage Range	1.8		5.5	V
V _{OUT}	Output Voltage Range	0		5.5	V
V _{IH}	ON Pin High Voltage Range	1		5.5	V
V _{IL}	ON Pin Low Voltage Range	0		0.35	V
I _{LIM}	Output Current Limit (TPS22950)	0.05		3.5	A
I _{LIM}	Output Current Limit (TPS22950L)	0.5		3.5	A
T _A	Ambient temperature	- 40		125	°C
T _J	Junction temperature	- 40		150	°C

7.4 Thermal Information

	THERMAL METRIC ⁽¹⁾	TPS22950	UNIT
		YBH (WCSP)	
		6 PINS	
R _{θJA}	Junction-to-ambient thermal resistance	135.8	°C/W
R _{θJC(top)}	Junction-to-case (top) thermal resistance	1.4	°C/W
R _{θJB}	Junction-to-board thermal resistance	39.5	°C/W
Ψ _{JT}	Junction-to-top characterization parameter	0.9	°C/W

7.4 Thermal Information (continued)

THERMAL METRIC ⁽¹⁾		TPS22950	UNIT
		YBH (WCSP)	
		6 PINS	
Ψ_{JB}	Junction-to-board characterization parameter	39.5	°C/W

(1) For more information about traditional and new thermal metrics, see the [Semiconductor and IC Package Thermal Metrics](#) application report.

7.5 Electrical Characteristics

Unless otherwise noted, the characteristics in the following table apply across the recommended operating input voltage range with a load of $C_L = 0.1 \mu\text{F}$, $R_L = 100 \Omega$. Typical Values are at 5 V and $T_A = 25^\circ\text{C}$.

PARAMETER		TEST CONDITIONS	MIN	TYP	MAX	UNIT	
Input Supply (VIN)							
$I_{Q, VIN}$	VIN Quiescent Current	$V_{ON} \geq V_{IH}$, $V_{OUT} = \text{Open}$	-40°C to 85°C	44	60	μA	
			-40°C to 125°C		60	μA	
$I_{SD, VIN}$	VIN Shutdown Current	$V_{ON} \leq V_{IL}$, $V_{OUT} = \text{GND}$	25°C	0.2	0.4	μA	
			-40°C to 85°C		9	μA	
			-40°C to 125°C		46	μA	
ON-Resistance (RON)							
R_{ON}	ON-State Resistance	$V_{IN} = 5 \text{ V}$, $I_{OUT} = -200 \text{ mA}$	25°C	34	41	$\text{m}\Omega$	
			-40°C to 85°C		49	$\text{m}\Omega$	
			-40°C to 125°C		54	$\text{m}\Omega$	
		$V_{IN} = 3.3 \text{ V}$, $I_{OUT} = -200 \text{ mA}$	25°C	41	51	$\text{m}\Omega$	
			-40°C to 85°C		62	$\text{m}\Omega$	
			-40°C to 125°C		68	$\text{m}\Omega$	
		$V_{IN} = 1.8 \text{ V}$, $I_{OUT} = -200 \text{ mA}$	25°C	67	90	$\text{m}\Omega$	
			-40°C to 85°C		105	$\text{m}\Omega$	
			-40°C to 125°C		116	$\text{m}\Omega$	
Output Current Limit (ILIM)							
I_{LIM}	Output Current Limit	$R_{ILIM} = 610 \Omega$ $V_{IN} - V_{OUT} = 0.5 \text{ V}$	-40°C to 125°C	1.54	2	2.46	A
		$R_{ILIM} = 1.15 \text{ k}\Omega$ $V_{IN} - V_{OUT} = 0.5 \text{ V}$	-40°C to 125°C	0.75	1	1.25	A
		$R_{ILIM} = 2.21 \text{ k}\Omega$ $V_{IN} - V_{OUT} = 0.5 \text{ V}$	-40°C to 125°C	0.38	0.5	0.62	A
		$R_{ILIM} = 19.2 \text{ k}\Omega$ $V_{IN} - V_{OUT} = 0.5 \text{ V}$	-40°C to 125°C	0.034	0.05	0.066	A
$I_{LIM, PEAK}$	Output Current Limit Peak (TPS22950L)	$R_{ILIM} = 624 \Omega$ $V_{IN} - V_{OUT} = 1 \text{ V}$	-40°C to 125°C	2.1		A	
		$R_{ILIM} = 1.24 \text{ k}\Omega$ $V_{IN} - V_{OUT} = 1 \text{ V}$	-40°C to 125°C	1		A	
		$R_{ILIM} = 2.49 \text{ k}\Omega$ $V_{IN} - V_{OUT} = 1 \text{ V}$	-40°C to 125°C	0.52		A	
t_{LIM}	Current Limit Response Time	Output hard short ($I_{OUT} > I_{LIM}$)	-40°C to 125°C	5		μs	
$t_{DEBOUNCE}$	Latch Off Debounce Time (TPS22950L)	$V_{IN} - V_{OUT} = 0.5 \text{ V}$	-40°C to 125°C	120	188	μs	

7.5 Electrical Characteristics (continued)

Unless otherwise noted, the characteristics in the following table apply across the recommended operating input voltage range with a load of $C_L = 0.1 \mu\text{F}$, $R_L = 100 \Omega$. Typical Values are at 5 V and $T_A = 25^\circ\text{C}$.

PARAMETER		TEST CONDITIONS		MIN	TYP	MAX	UNIT
I_{HCD}	High current detection threshold (TPS22950L)	$R_{\text{ILIM}} = 624 \Omega$	-40°C to 125°C	1.2	1.6	1.9	A
		$R_{\text{ILIM}} = 1.25 \text{ k}\Omega$	-40°C to 125°C	0.6	0.85	1.1	A
		$R_{\text{ILIM}} = 2.5 \text{ k}\Omega$	-40°C to 125°C	0.3	0.47	0.65	A
Reverse Current Blocking (TPS22950)							
V_{RCB}	Activation Threshold	V_{OUT} Rising; $V_{\text{OUT}} > V_{\text{IN}}$	-40°C to 125°C	44			mV
	Release Threshold	V_{OUT} Falling; $V_{\text{OUT}} > V_{\text{IN}}$	-40°C to 125°C	16			mV
t_{RCB}	Response Time	$V_{\text{OUT}} = V_{\text{IN}} + 1 \text{ V}$	-40°C to 125°C	3			μs
$I_{\text{OUT,RCB}}$	Reverse Leakage Current into VOUT	$V_{\text{ON}} \leq V_{\text{IL}}$ $V_{\text{IN}} = 0 \text{ V}$, $V_{\text{OUT}} = 5 \text{ V}$	-40°C to 125°C	38			μA
Fault Indication (FLT)							
$V_{\text{OL,FLT}}$	Output Low Voltage	$I_{\text{FLT}} = 1 \text{ mA}$	-40°C to 125°C	0.1			V
$t_{\text{D,FLT}}$	Fault Delay Time	$V_{\text{ON}} \geq V_{\text{IH}}$	-40°C to 125°C	10			μs
I_{FLT}	Off State Leakage	$V_{\text{ON}} \leq V_{\text{IL}}$	-40°C to 125°C	50			nA
Enable Pin (ON)							
$R_{\text{PD,ON}}$	Smart Pull Down Resistance	$V_{\text{ON}} \leq V_{\text{IL}}$	-40°C to 125°C	500	650		$\text{k}\Omega$
I_{ON}	ON Pin Leakage	$V_{\text{ON}} \geq V_{\text{IH}}$	-40°C to 125°C	50			nA
R_{QOD}	Quick Output Discharge Resistance	$V_{\text{IN}} = 5 \text{ V}$ $V_{\text{ON}} \leq V_{\text{IL}}$	-40°C to 125°C	100	160		Ω
		$V_{\text{IN}} = 3.3 \text{ V}$ $V_{\text{ON}} \leq V_{\text{IL}}$	-40°C to 125°C	150	185		Ω
		$V_{\text{IN}} = 1.8 \text{ V}$ $V_{\text{ON}} \leq V_{\text{IL}}$	-40°C to 125°C	200	355		Ω
Thermal Shutdown (TSD)							
TSD	Thermal Shutdown	Rising	N/A	170			$^\circ\text{C}$
		Falling (Hysteresis)	N/A	150			$^\circ\text{C}$

7.6 Switching Characteristics

Unless otherwise noted, the typical characteristics in the following table applies at 25°C with a load of $C_L = 1 \mu\text{F}$, $R_L = 100 \Omega$

PARAMETER		TEST CONDITIONS		MIN	TYP	MAX	UNIT
t_{ON}	Turn ON Time	$V_{\text{IN}} = 5 \text{ V}$		800			μs
		$V_{\text{IN}} = 3.3 \text{ V}$		550			μs
		$V_{\text{IN}} = 1.8 \text{ V}$		400			μs
t_{R}	Output Rise Time	$V_{\text{IN}} = 5 \text{ V}$		600			μs
		$V_{\text{IN}} = 3.3 \text{ V}$		320			μs
		$V_{\text{IN}} = 1.8 \text{ V}$		200			μs
t_{D}	Output Delay Time	$V_{\text{IN}} = 5 \text{ V}$		260			μs
		$V_{\text{IN}} = 3.3 \text{ V}$		250			μs
		$V_{\text{IN}} = 1.8 \text{ V}$		260			μs
t_{OFF}	Turn OFF Time	$V_{\text{IN}} = 5 \text{ V}$		20			μs
		$V_{\text{IN}} = 3.3 \text{ V}$		15			μs
		$V_{\text{IN}} = 1.8 \text{ V}$		17			μs

Unless otherwise noted, the typical characteristics in the following table applies at 25°C with a load of $C_L = 1 \mu\text{F}$, $R_L = 100 \Omega$

PARAMETER		TEST CONDITIONS	MIN	TYP	MAX	UNIT
t_{FALL}	Output Fall Time	$V_{\text{IN}} = 5 \text{ V}$		118		μs
		$V_{\text{IN}} = 3.3 \text{ V}$		120		μs
		$V_{\text{IN}} = 1.8 \text{ V}$		130		μs

7.7 Typical Characteristics

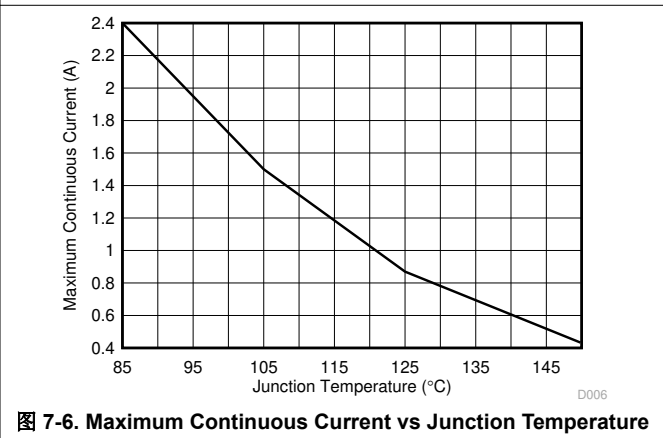
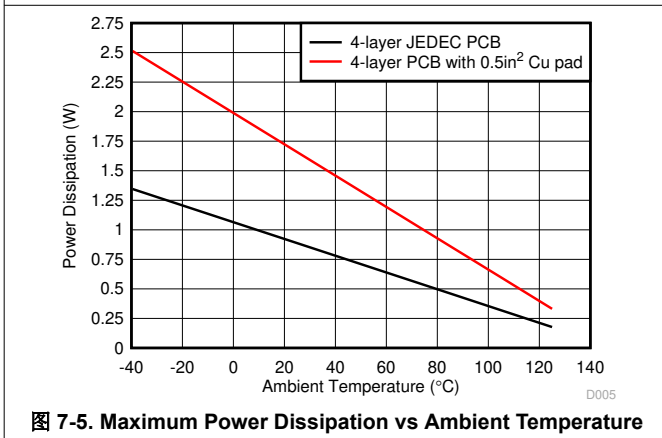
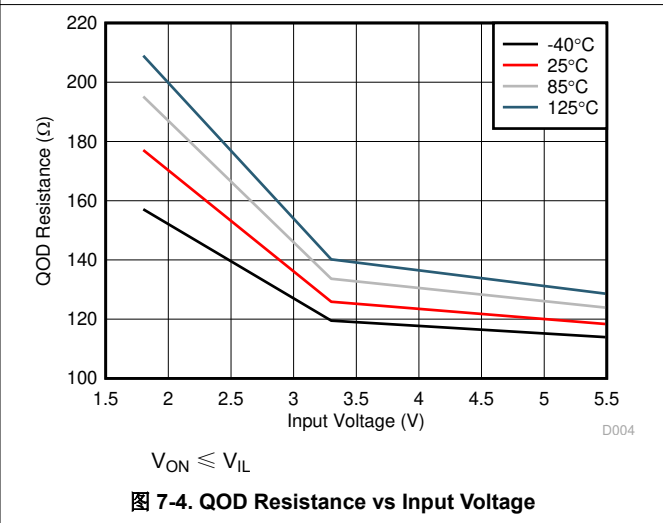
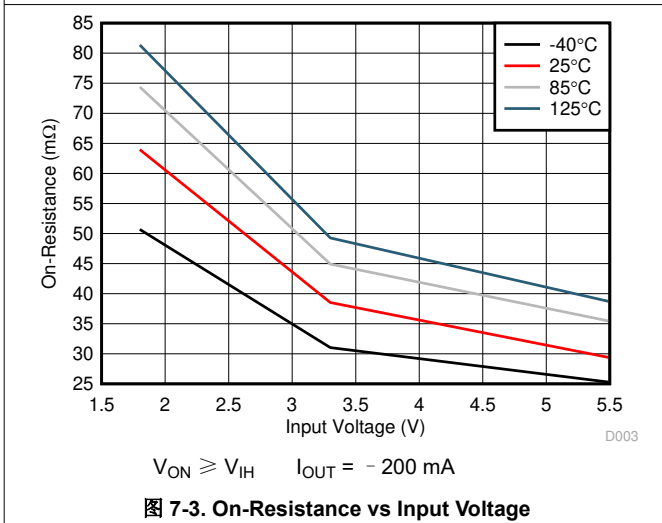
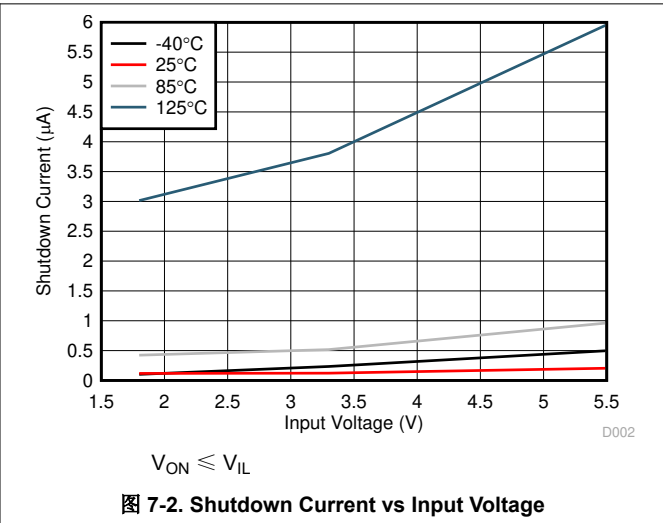
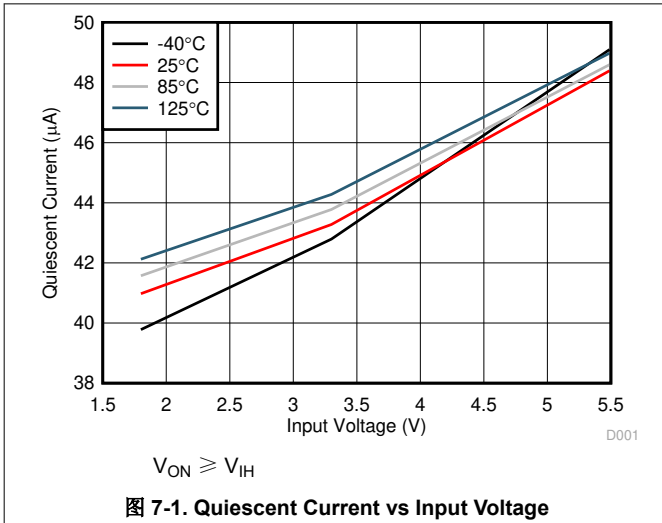

7.7 Typical Characteristics (continued)

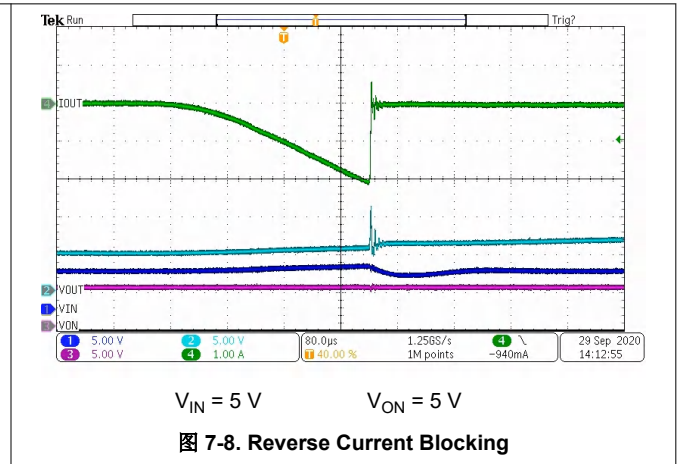
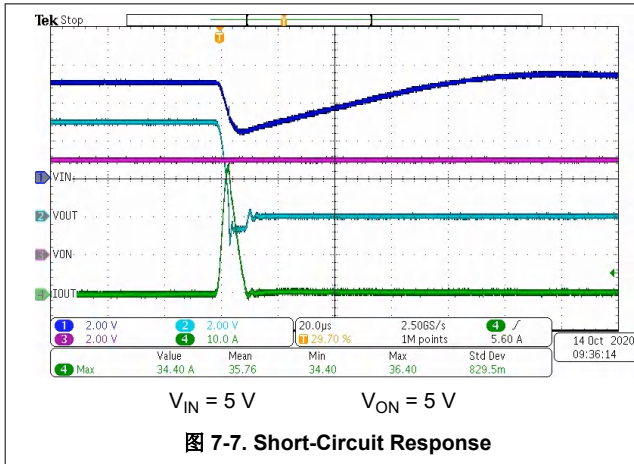

8 Parameter Measurement Information



图 8-1. Timing Waveform

9 Detailed Description

9.1 Overview

The TPS22950x is a single channel load switch with a 34-mΩ power MOSFET capable of driving loads up to 2.7 A. While on, the device provides protection against fault cases through its adjustable output current limiting and thermal shutdown. The TPS22950 responds to overcurrent events with auto-retry behavior, while the TPS22950L uses a debounce time and latch off behavior. The TPS22950 also provides reverse current blocking for when V_{OUT} exceeds V_{IN} .

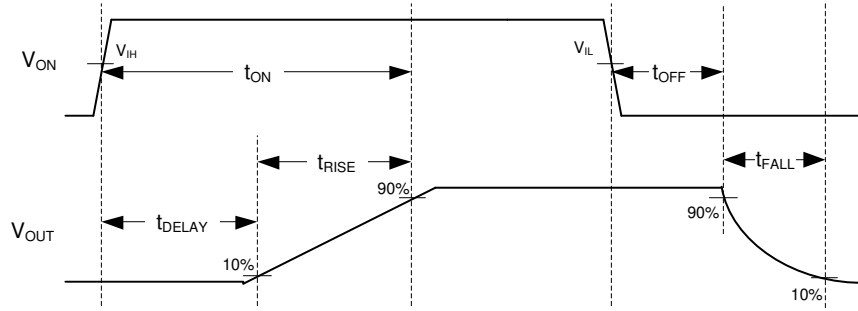
The switch ON state is controlled by a digital input that is capable of interfacing directly with low-voltage control signals, and a Smart Pulldown is used to keep the ON pin from floating until system sequencing is complete. When the device is turned off, quick output discharge is enabled, pulling the output voltage down to 0 V through a resistive path to GND.

9.2 Functional Block Diagram

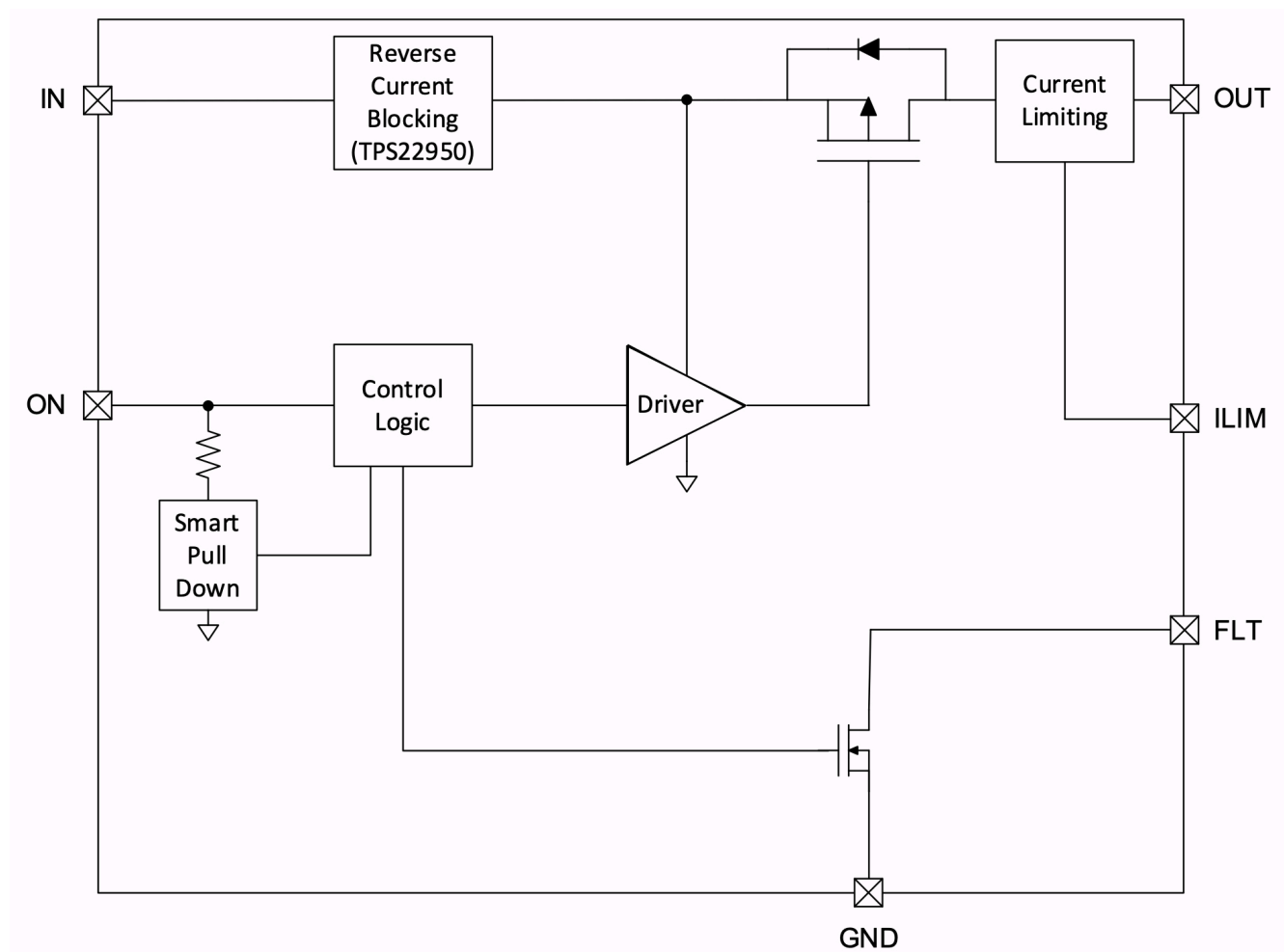

9.3 Feature Description

9.3.1 Current Limiting (TPS22950)

The TPS22950 responds to overcurrent conditions by limiting its output current to the I_{LIM} level shown in the figure below.



图 9-1. Output Current Limit for Short-Circuit Protection (t_{LIM})

When an overcurrent condition is detected, the device maintains a constant output current and reduces the output voltage accordingly. Two possible overload conditions can occur.

The first condition is when a short circuit or partial short circuit is present on the output and the ON pin is toggled high, turning the device on. The output voltage is held near zero potential with respect to ground and the TPS22950 ramps the output current to I_{LIM} . The TPS22950 device limits the current to I_{LIM} until the overload condition is removed or the internal junction temperature of the device reaches thermal shutdown and the device turns itself off. The device remains off until the junction temperature has lowered to TSD_{HYS} , and the device turns itself back on. This action cycles until the overload condition is removed.

The second condition is when a short circuit, partial short circuit, or transient overload occurs after the device has been fully powered on. The device responds to the overcurrent condition within time t_{LIM} (see figure below), and before this time the current is able to exceed I_{LIM} . In the case of a fast transient, the current-sense amplifier is over-driven and momentarily disables the internal power FET. The current-sense amplifier recovers and limits the output current to I_{LIM} . Similar to the previous case, the TPS22950 limits the current to I_{LIM} until the overload condition is removed or the internal junction temperature of the device reaches thermal shutdown and begins thermally cycling on and off.

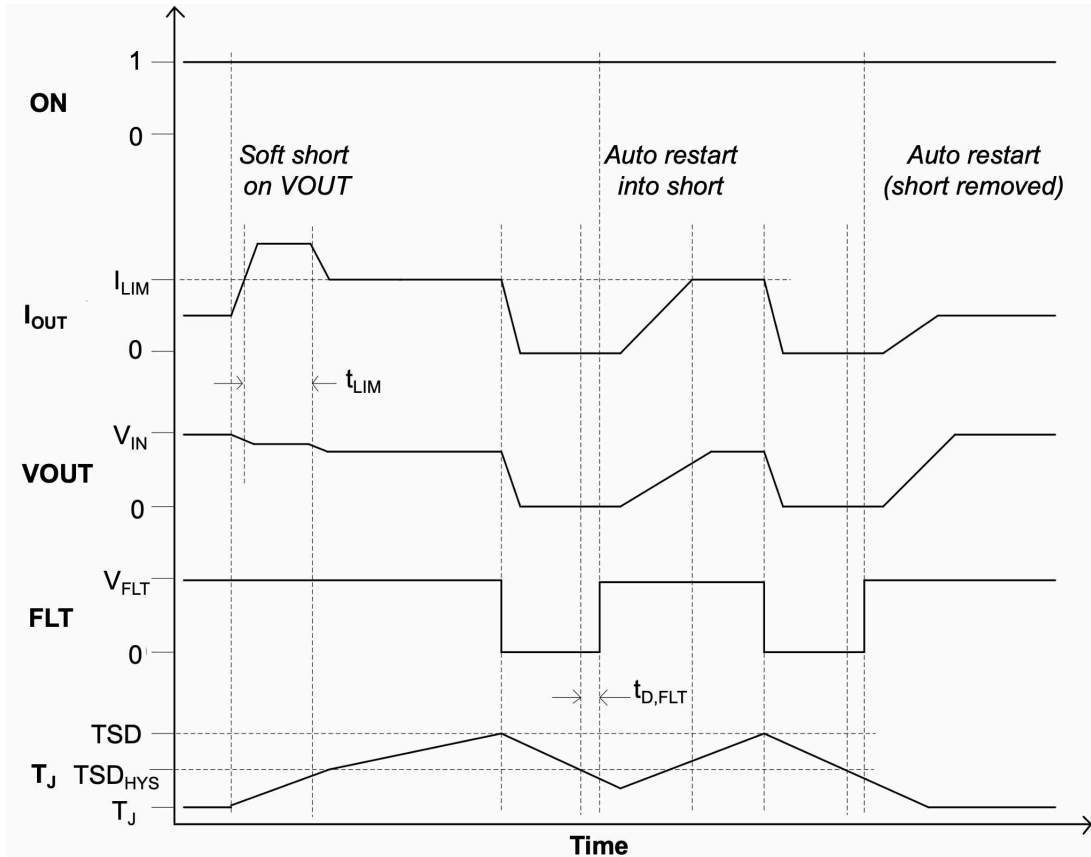

图 9-2. Transient Current Limit Waveform

9.3.2 Current Limiting (TPS22950L)

The TPS22950L responds to overcurrent conditions by limiting its output current to the current limit (I_{LIM}) level after initially peaking its current at $I_{LIM,PEAK}$. The behavior of the device is shown in the figure below.

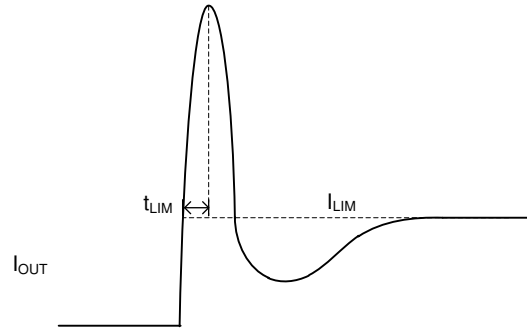

图 9-3. Output Current Limit Behavior

When an overcurrent condition is detected, the device maintains a constant output current and reduces the output voltage accordingly. Two possible overload conditions can occur.

The first condition is when a short circuit or partial short circuit is present on the output and the ON pin is toggled high, turning the device on. The output voltage is held near zero potential with respect to ground and the TPS22950L ramps the output current to I_{LIM} . The TPS22950L device limits the current to I_{LIM} until the overload condition is removed. If the internal junction temperature of the device reaches thermal shutdown, the device turns itself off. The device remains off until the junction temperature has lowered to TSD_{HYS} , and the device turns itself back on. If thermal shutdown is not reached, the device waits for the load current to exceed the high

current detection level (I_{HCD}) for the $t_{DEBOUNCE}$ time and latch itself off. The FLT pin is pulled low, and the device is only able to turn on again by toggling the VIN or ON pins.

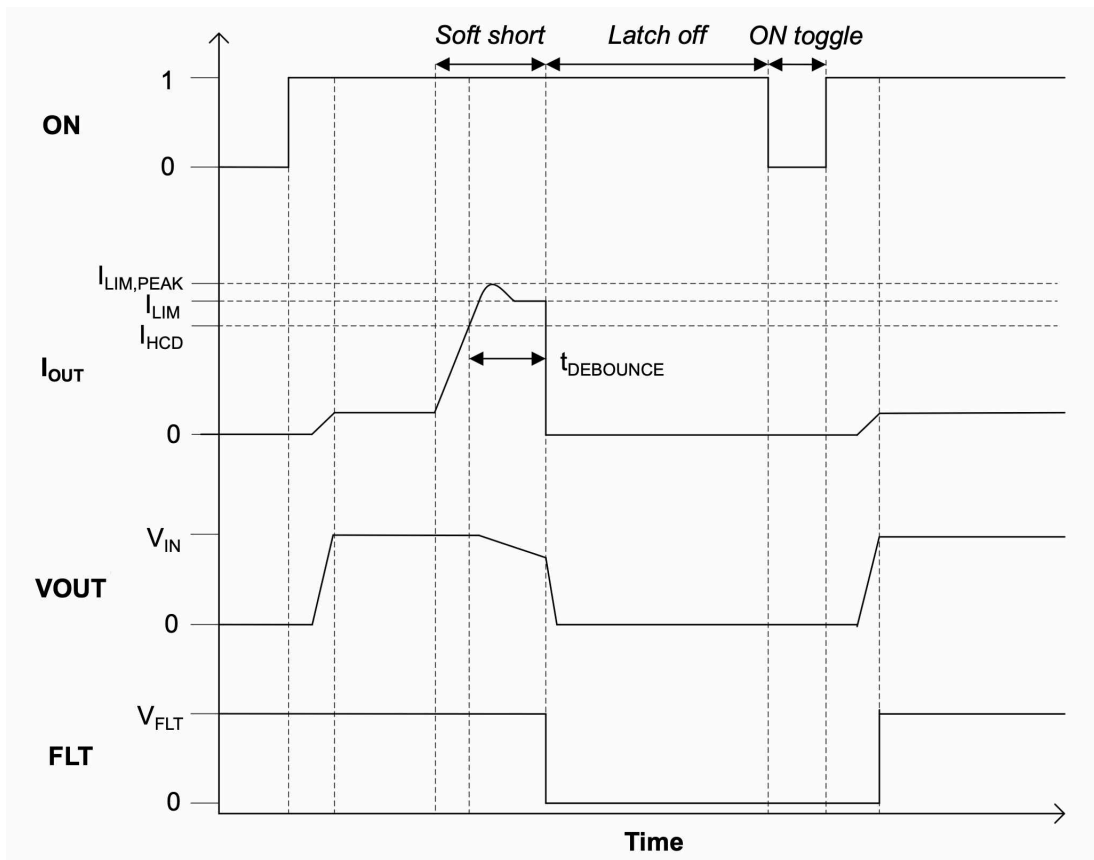
The second condition is when a short circuit, partial short circuit, or transient overload occurs after the device has been fully powered on. The device responds to the overcurrent condition within time t_{LIM} (see figure below), and before this time the current is able to exceed I_{LIM} . In the case of a fast transient, the current-sense amplifier is over-driven and momentarily disables the internal power FET. The current-sense amplifier recovers and limits the output current to I_{LIM} . Similar to the previous case, the TPS22950L limits the current to I_{LIM} until the overload condition is removed, the debounce time of 120 μ s is reached, or the internal junction temperature of the device reaches thermal shutdown and begins thermally cycling on and off.



图 9-4. Transient Current Limit Waveform

9.3.3 Adjusting the Current Limit

The current limit is adjusted by connecting an external resistor from the ILIM pin to GND. The current limit resistor can be chosen using the equation:

$$I_{LIM} = 1.18 \times (R_{ILIM})^{-1.072} \quad (1)$$

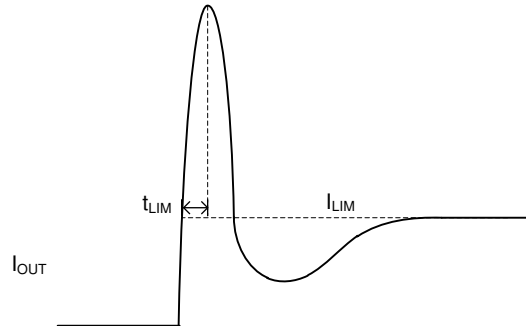
The units for the equation are amps for I_{LIM} and kilohms for R_{ILIM} . For the TPS22950L, the device is only limiting current during a short period of time. Therefore, the peak value of the current ($I_{LIM,PEAK}$) may be more applicable for system considerations. The equation for this parameter is below:

$$I_{LIM,PEAK} = 1.31 \times (R_{ILIM})^{-1.042} \quad (2)$$

The R_{ILIM} resistor is also used to set the high current detection threshold for the TPS22950L, and that equation is shown below.

$$I_{HCD} = (0.988 / R_{ILIM}) + 0.06 \quad (3)$$

The units for the equation are amps for I_{HCD} and kilohms for R_{ILIM} .

9.3.4 Reverse Current Blocking (TPS22950)

In a scenario where the device is enabled and V_{OUT} is greater than V_{IN} , there is potential for reverse current to flow through the pass FET or the body diode. When the reverse current threshold is exceeded (about 900 mA), there is a delay time (t_{RCB}) before the switch turns off to stop the current flow. The switch remains off and block reverse current as long as the reverse voltage condition exists. After V_{OUT} has dropped below the release voltage threshold (V_{RCB}) the device turns back on. When the ON pin is pulled low, the device constantly blocks reverse current.

9.4 Device Functional Modes

The tables below summarize the Device Functional Modes.

表 9-1. Output Connection Table

ON	Fault Condition	VOUT State	FLT State
L	N/A	Hi-Z	Hi-Z

表 9-1. Output Connection Table (continued)

ON	Fault Condition	VOUT State	FLT State
H	None	VIN (via R _{ON})	Hi-Z
H	Output short	Current Limited	Hi-Z
H	Thermal shutdown	Hi-Z	L
H	Reverse current	Hi-Z	L

表 9-2. Smart-ON Functional Modes (R_{PD,ON})

ON	ON Pin
$\leq V_{IL}$	Pulldown active
$\geq V_{IH}$	No pulldown

10 Application and Implementation

备注

以下应用部分中的信息不属于 TI 器件规格的范围，TI 不担保其准确性和完整性。TI 的客户应负责确定器件是否适用于其应用。客户应验证并测试其设计，以确保系统功能。

10.1 Application Information

This section highlights some of the design considerations when implementing this device in various applications.

10.2 Typical Application

This typical application demonstrates how the TPS22950x device can be used to set an adjustable current limit.



图 10-1. Typical Application

10.2.1 Design Requirements

For this example, the values below are used as the design parameters.

表 10-1. Design Parameters

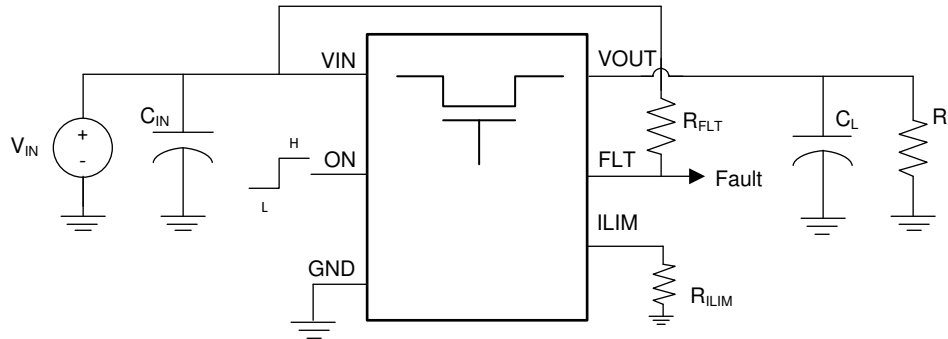
PARAMETER	VALUE
Input Voltage (V_{IN})	5 V
Load Current (mA)	100 mA
Typical Current Limit (mA)	500 mA

10.2.2 Detailed Design Procedure

In this example the nominal load current is 100 mA, so the current limit can be set to 500 mA without disrupting normal operation. Use 方程式 4 to calculate the resistor needed on the ILIM pin.

$$I_{LIM} = 1.18 \times (R_{ILIM})^{-1.072} \quad (4)$$

where

- I_{LIM} = Typical current limit setting
- R_{ILIM} = Resistor on the ILIM pin

Based on 方程式 4, a 2.21-k Ω resistor must be used on the ILIM pin to set a typical current limit of 500 mA.

10.2.3 Application Curves

The below scope shot shows the device turning on into a fault condition and limiting the current to the specified amount of 500 mA.

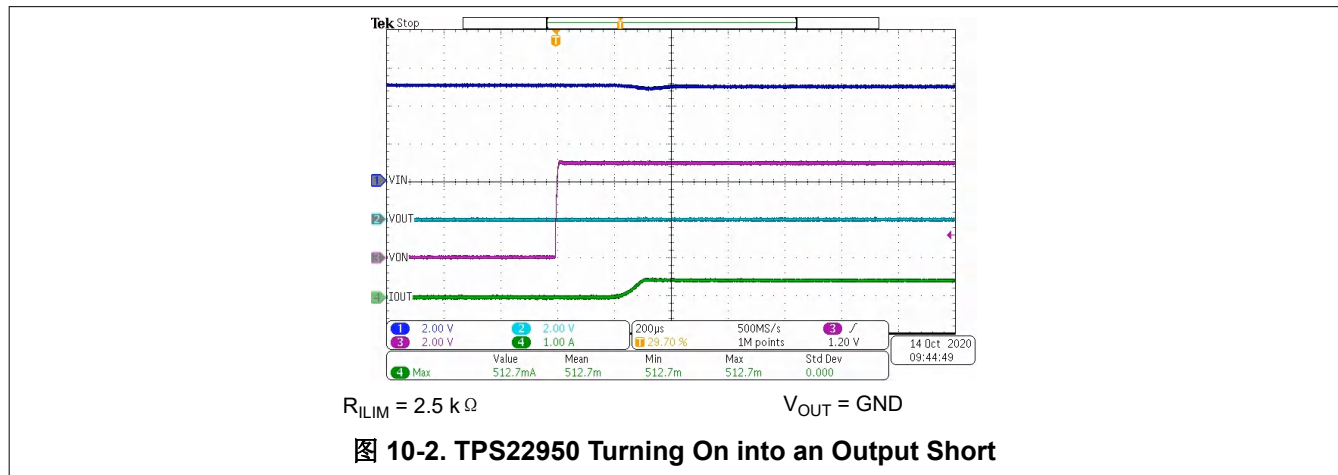

11 Power Supply Recommendations

The device is designed to operate with a VIN range of 1.8 V to 5.5 V. The VIN power supply must be well regulated and placed as close to the device terminal as possible. The power supply must be able to withstand all transient load current steps. In most situations, using an input capacitance (CIN) of 1 μ F is sufficient to prevent the supply voltage from dipping when the switch is turned on. In cases where the power supply is slow to respond to a large transient current or large load current step, additional bulk capacitance may be required on the input.

12 Layout

12.1 Layout Guidelines

For best performance, all traces must be as short as possible. To be most effective, the input and output capacitors must be placed close to the device to minimize the effects that parasitic trace inductances may have on normal operation. Using wide traces for VIN, VOUT, and GND helps minimize the parasitic electrical effects.

12.2 Layout Example



图 12-1. TPS22950x Layout Example

13 Device and Documentation Support

TI offers an extensive line of development tools. Tools and software to evaluate the performance of the device, generate code, and develop solutions are listed below.

13.1 接收文档更新通知

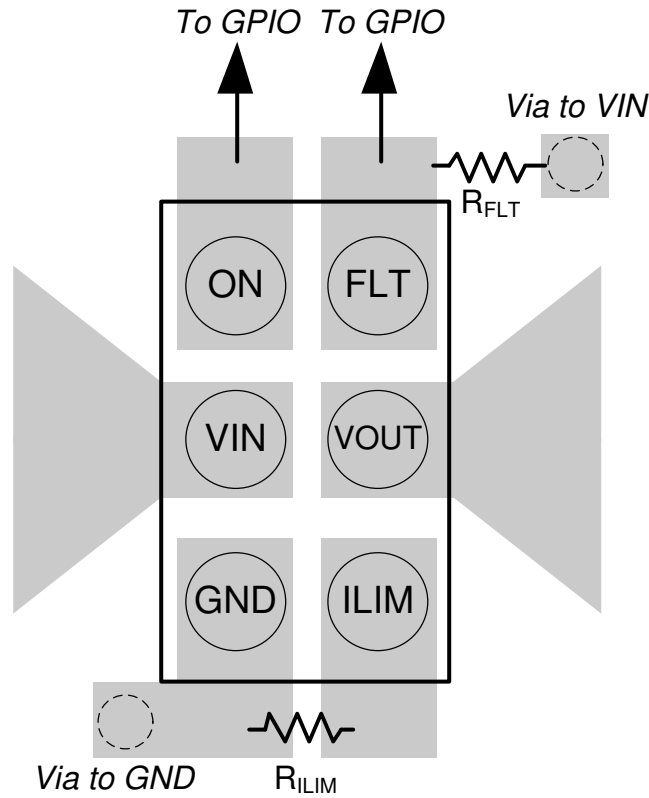
要接收文档更新通知，请导航至 ti.com 上的器件产品文件夹。点击 [订阅更新](#) 进行注册，即可每周接收产品信息更改摘要。有关更改的详细信息，请查看任何已修订文档中包含的修订历史记录。

13.2 支持资源

[TI E2E™ 支持论坛](#) 是工程师的重要参考资料，可直接从专家获得快速、经过验证的解答和设计帮助。搜索现有解答或提出自己的问题可获得所需的快速设计帮助。

链接的内容由各个贡献者“按原样”提供。这些内容并不构成 TI 技术规范，并且不一定反映 TI 的观点；请参阅 TI 的 [《使用条款》](#)。

13.3 Trademarks

TI E2E™ is a trademark of Texas Instruments.

所有商标均为其各自所有者的财产。

13.4 Electrostatic Discharge Caution



This integrated circuit can be damaged by ESD. Texas Instruments recommends that all integrated circuits be handled with appropriate precautions. Failure to observe proper handling and installation procedures can cause damage.

ESD damage can range from subtle performance degradation to complete device failure. Precision integrated circuits may be more susceptible to damage because very small parametric changes could cause the device not to meet its published specifications.

13.5 术语表

[TI 术语表](#) 本术语表列出并解释了术语、首字母缩略词和定义。

14 Mechanical, Packaging, and Orderable Information

The following pages include mechanical, packaging, and orderable information. This information is the most current data available for the designated devices. This data is subject to change without notice and revision of this document. For browser-based versions of this data sheet, refer to the left-hand navigation.

PACKAGE OUTLINE

YBH0006-C02

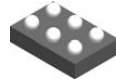

DSBGA - 0.4 mm max height

DIE SIZE BALL GRID ARRAY

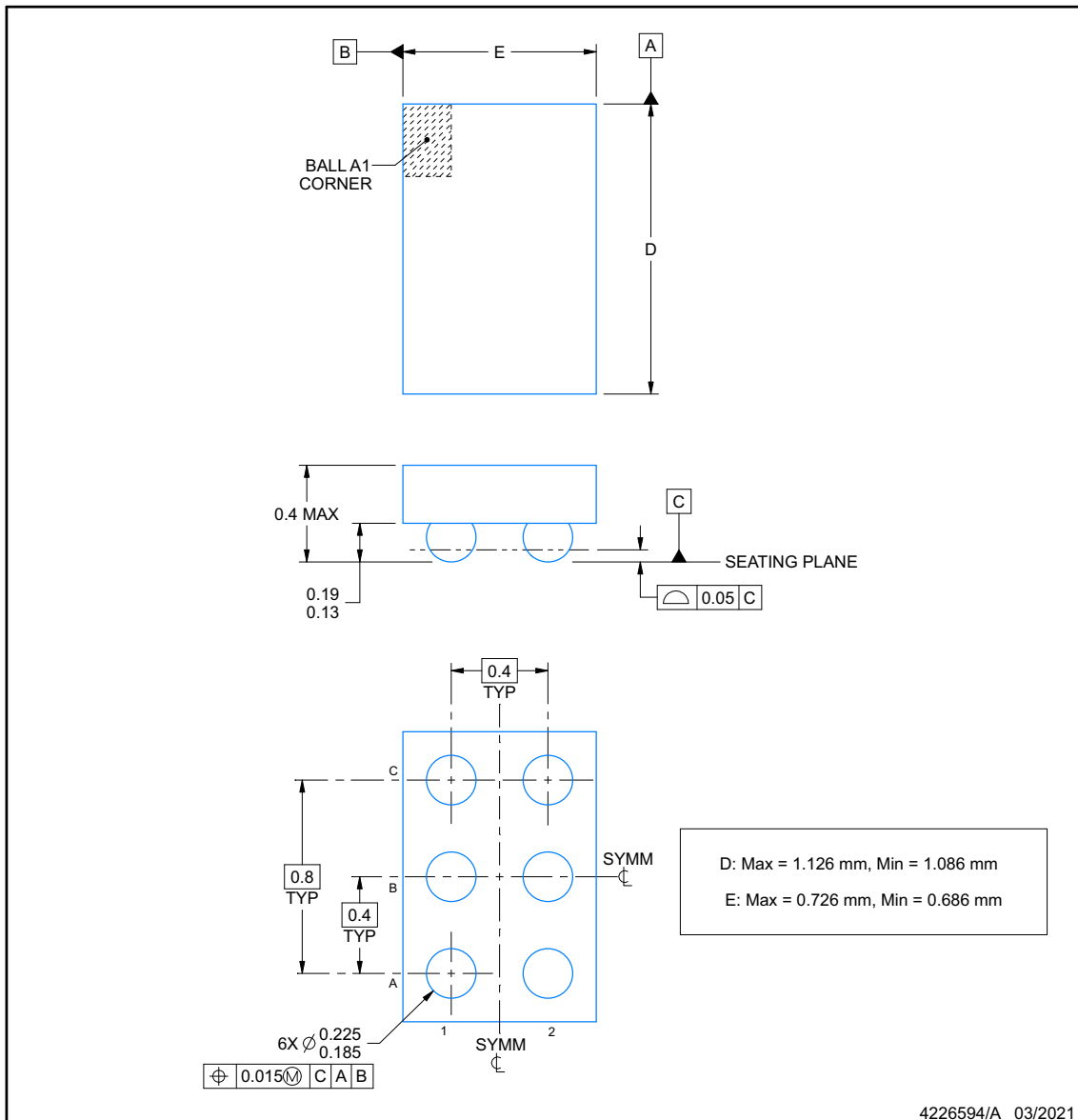

NOTES:

1. All linear dimensions are in millimeters. Any dimensions in parenthesis are for reference only. Dimensioning and tolerancing per ASME Y14.5M.
2. This drawing is subject to change without notice.

EXAMPLE BOARD LAYOUT

YBH0006-C02

DSBGA - 0.4 mm max height

DIE SIZE BALL GRID ARRAY

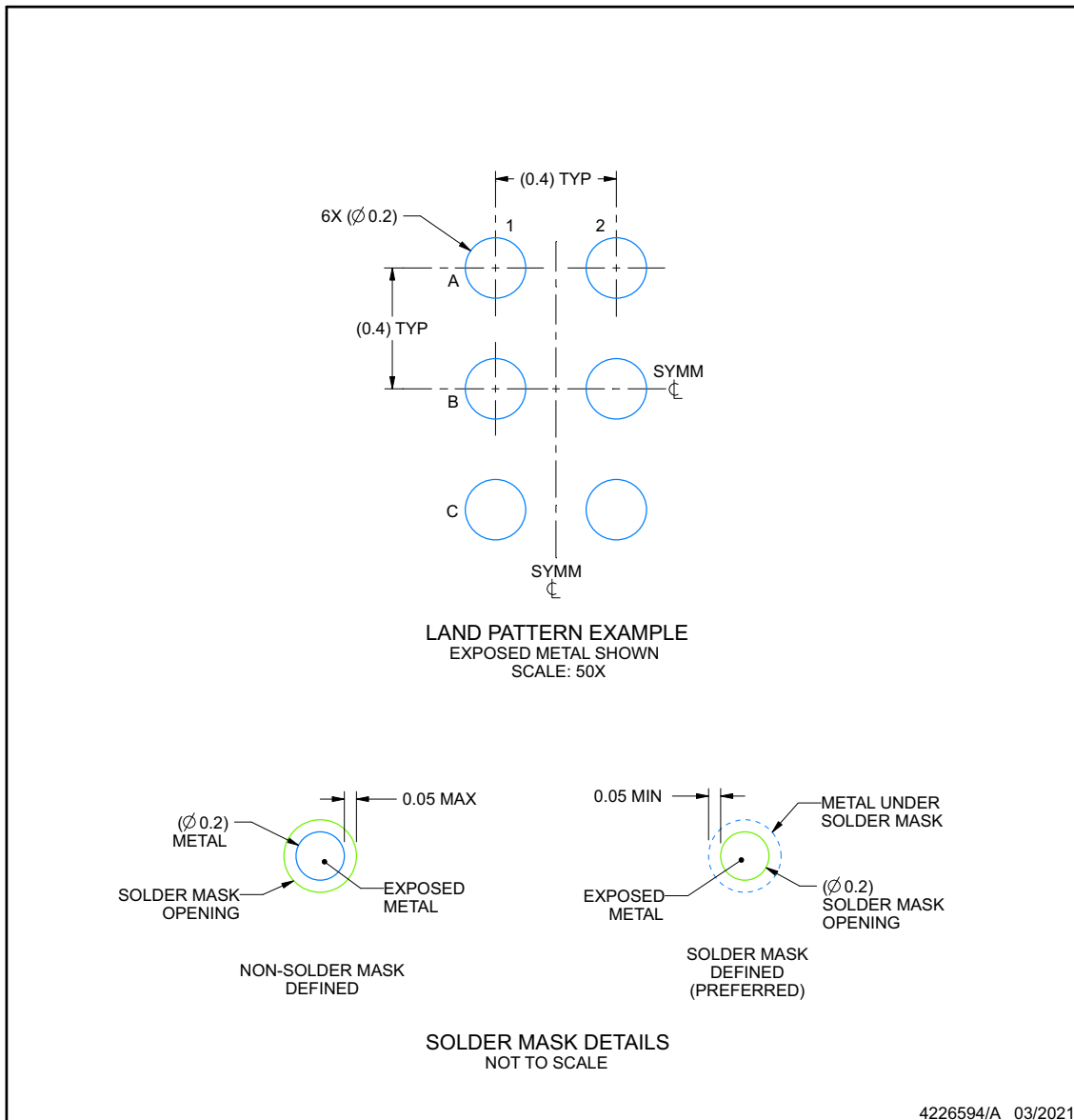

NOTES: (continued)

- Final dimensions may vary due to manufacturing tolerance considerations and also routing constraints. See Texas Instruments Literature No. SNVA009 (www.ti.com/lit/snva009).

EXAMPLE STENCIL DESIGN

YBH0006-C02

DSBGA - 0.4 mm max height

DIE SIZE BALL GRID ARRAY

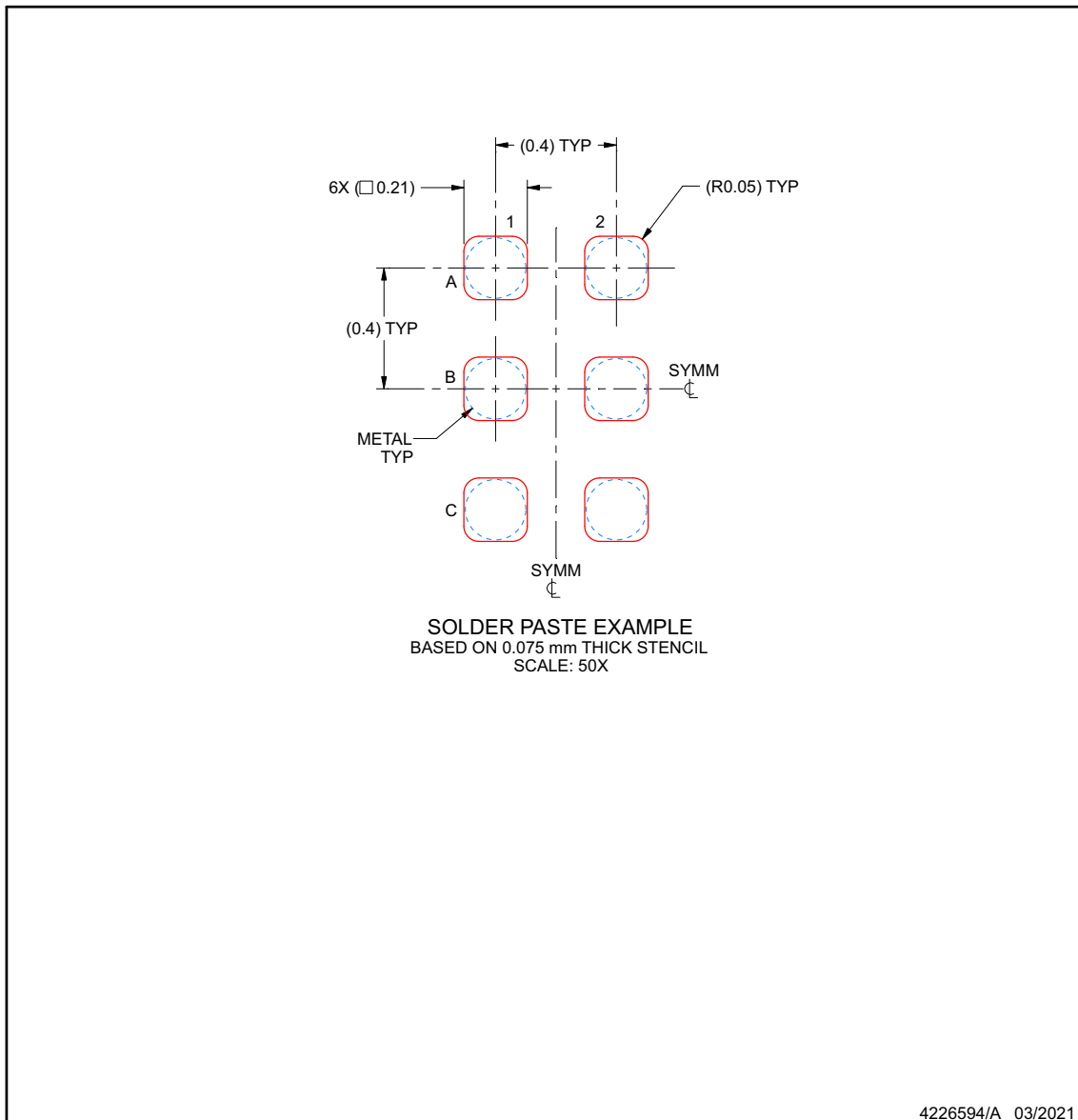

NOTES: (continued)

4. Laser cutting apertures with trapezoidal walls and rounded corners may offer better paste release.

PACKAGING INFORMATION

Orderable Device	Status (1)	Package Type	Package Drawing	Pins	Package Qty	Eco Plan (2)	Lead finish/ Ball material (6)	MSL Peak Temp (3)	Op Temp (°C)	Device Marking (4/5)	Samples
PTPS22950LYBHR	ACTIVE	DSBGA	YBH	6	3000	TBD	Call TI	Call TI	-40 to 125		Samples
TPS22950LYBHR	ACTIVE	DSBGA	YBH	6	3000	RoHS & Green	SNAGCU	Level-1-260C-UNLIM	-40 to 125	4	Samples
TPS22950YBHR	ACTIVE	DSBGA	YBH	6	3000	RoHS & Green	SNAGCU	Level-1-260C-UNLIM	-40 to 125		Samples

(1) The marketing status values are defined as follows:

ACTIVE: Product device recommended for new designs.

LIFEBUY: TI has announced that the device will be discontinued, and a lifetime-buy period is in effect.

NRND: Not recommended for new designs. Device is in production to support existing customers, but TI does not recommend using this part in a new design.

PREVIEW: Device has been announced but is not in production. Samples may or may not be available.

OBSOLETE: TI has discontinued the production of the device.

(2) **RoHS:** TI defines "RoHS" to mean semiconductor products that are compliant with the current EU RoHS requirements for all 10 RoHS substances, including the requirement that RoHS substance do not exceed 0.1% by weight in homogeneous materials. Where designed to be soldered at high temperatures, "RoHS" products are suitable for use in specified lead-free processes. TI may reference these types of products as "Pb-Free".

RoHS Exempt: TI defines "RoHS Exempt" to mean products that contain lead but are compliant with EU RoHS pursuant to a specific EU RoHS exemption.

Green: TI defines "Green" to mean the content of Chlorine (Cl) and Bromine (Br) based flame retardants meet JS709B low halogen requirements of <=1000ppm threshold. Antimony trioxide based flame retardants must also meet the <=1000ppm threshold requirement.

(3) MSL, Peak Temp. - The Moisture Sensitivity Level rating according to the JEDEC industry standard classifications, and peak solder temperature.

(4) There may be additional marking, which relates to the logo, the lot trace code information, or the environmental category on the device.

(5) Multiple Device Markings will be inside parentheses. Only one Device Marking contained in parentheses and separated by a "~" will appear on a device. If a line is indented then it is a continuation of the previous line and the two combined represent the entire Device Marking for that device.

(6) Lead finish/Ball material - Orderable Devices may have multiple material finish options. Finish options are separated by a vertical ruled line. Lead finish/Ball material values may wrap to two lines if the finish value exceeds the maximum column width.

Important Information and Disclaimer:The information provided on this page represents TI's knowledge and belief as of the date that it is provided. TI bases its knowledge and belief on information provided by third parties, and makes no representation or warranty as to the accuracy of such information. Efforts are underway to better integrate information from third parties. TI has taken and continues to take reasonable steps to provide representative and accurate information but may not have conducted destructive testing or chemical analysis on incoming materials and chemicals. TI and TI suppliers consider certain information to be proprietary, and thus CAS numbers and other limited information may not be available for release.

In no event shall TI's liability arising out of such information exceed the total purchase price of the TI part(s) at issue in this document sold by TI to Customer on an annual basis.

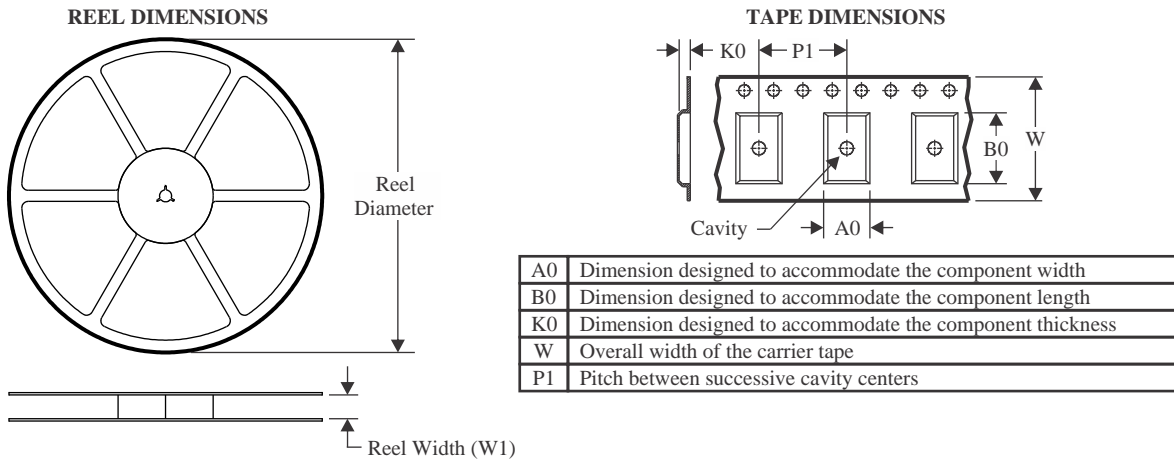
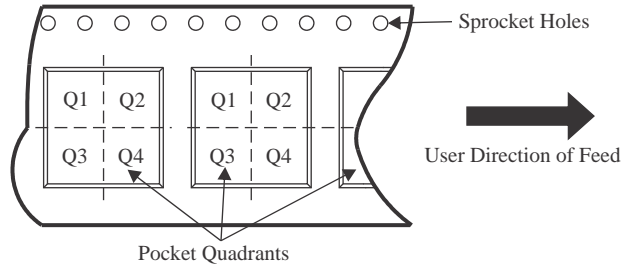
TAPE AND REEL INFORMATION

QUADRANT ASSIGNMENTS FOR PIN 1 ORIENTATION IN TAPE

*All dimensions are nominal

Device	Package Type	Package Drawing	Pins	SPQ	Reel Diameter (mm)	Reel Width W1 (mm)	A0 (mm)	B0 (mm)	K0 (mm)	P1 (mm)	W (mm)	Pin1 Quadrant
TPS22950LYBHR	DSBGA	YBH	6	3000	180.0	8.4	0.8	1.21	0.43	2.0	8.0	Q1
TPS22950YBHR	DSBGA	YBH	6	3000	180.0	8.4	0.8	1.21	0.43	2.0	8.0	Q1

TAPE AND REEL BOX DIMENSIONS

*All dimensions are nominal

Device	Package Type	Package Drawing	Pins	SPQ	Length (mm)	Width (mm)	Height (mm)
TPS22950LYBHR	DSBGA	YBH	6	3000	182.0	182.0	20.0
TPS22950YBHR	DSBGA	YBH	6	3000	182.0	182.0	20.0

重要声明和免责声明

TI“按原样”提供技术和可靠性数据（包括数据表）、设计资源（包括参考设计）、应用或其他设计建议、网络工具、安全信息和其他资源，不保证没有瑕疵且不做任何明示或暗示的担保，包括但不限于对适销性、某特定用途方面的适用性或不侵犯任何第三方知识产权的暗示担保。

这些资源可供使用 TI 产品进行设计的熟练开发人员使用。您将自行承担以下全部责任：(1) 针对您的应用选择合适的 TI 产品，(2) 设计、验证并测试您的应用，(3) 确保您的应用满足相应标准以及任何其他功能安全、信息安全、监管或其他要求。

这些资源如有变更，恕不另行通知。TI 授权您仅可将这些资源用于研发本资源所述的 TI 产品的应用。严禁对这些资源进行其他复制或展示。您无权使用任何其他 TI 知识产权或任何第三方知识产权。您应全额赔偿因在这些资源的使用中对 TI 及其代表造成的任何索赔、损害、成本、损失和债务，TI 对此概不负责。

TI 提供的产品受 [TI 的销售条款](#) 或 [ti.com](#) 上其他适用条款/TI 产品随附的其他适用条款的约束。TI 提供这些资源并不会扩展或以其他方式更改 TI 针对 TI 产品发布的适用的担保或担保免责声明。

TI 反对并拒绝您可能提出的任何其他或不同的条款。

邮寄地址：Texas Instruments, Post Office Box 655303, Dallas, Texas 75265

Copyright © 2022，德州仪器 (TI) 公司

X-ON Electronics

Largest Supplier of Electrical and Electronic Components

Click to view similar products for [Power Switch ICs - Power Distribution](#) *category:*

Click to view products by [Texas Instruments](#) *manufacturer:*

Other Similar products are found below :

[TLE6232GP](#) [NCP45520IMNTWG-L](#) [VND5E004ATR-E](#) [FPF1018](#) [DS1222](#) [NCV380HMUAJAATBG](#) [SZNCP3712ASNT3G](#)

[NCP45520IMNTWG-H](#) [VND5004ATR-E](#) [AP22811BW5-7](#) [SLG5NT1437VTR](#) [SZNCP3712ASNT1G](#) [DML1008LDS-7](#) [TS13011-QFNR](#)

[NCV459MNWTBG](#) [NCP4545IMNTWG-L](#) [NCV8412ASTT1G](#) [NCV8412ASTT3G](#) [FPF2260ATMX](#) [SLG5NT1765V](#) [SLG5NT1757V](#)

[NCP45780IMN24RTWG](#) [AP2151AMP-13](#) [NCP45540IMNTWG-L](#) [TPS2022P](#) [FPF2495BUCX](#) [NCP45650IMNTWG](#) [NCV8412ADDR2G](#)

[DK5V100R20S](#) [BTS7020-2EPA](#) [BTT6100-2ERA](#) [BTS71220-4ESA](#) [DK5V100R15M](#) [WS3220C9-9/TR](#) [AW32405CSR](#) [BTT6030-2ERA](#)

[TLE75602-ESH](#) [BTS5200-4EKA](#) [DK5V150R25M](#) [DK5V45R25](#) [DK5V100R25S](#) [AW35206FOR](#) [BTS7120-2EPA](#) [TLE75008-ESD](#)

[BTS7040-1EPA](#) [BTT6030-1ERA](#) [DK5V60R10S](#) [DK5V45R25S](#) [DK5V60R10](#) [DK5V45R15S](#)