

# TPS562242 采用 SOT-563 封装的 3V 至 17V 输入、2A 同步降压转换器

## 1 特性

- 专用于多种应用
  - 3V 至 17V 输入电压范围
  - 0.8V 至 10V 输出电压范围
  - 0.8V 基准电压
  - 25°C 时，基准精度为  $\pm 1\%$
  - 在 -40°C 至 125°C 温度范围内，基准精度为  $\pm 1.5\%$
  - 集成 55.0m $\Omega$  和 24.3m $\Omega$  MOSFET
  - 100  $\mu$ A 低静态电流
  - 1.4MHz 开关频率
  - 以最大 94% 的高占空比运行
  - 精密 EN 阈值电压
  - 1.6 ms 固定软启动时间 (典型值)
- 解决方案尺寸小巧且易于使用
  - 轻负载下采用 Eco-mode
  - 与 TPS562202 引脚对引脚兼容
  - D-CAP3™ 控制模式
  - 支持带预偏置输出的启动
  - 非锁存 OV、OT 和 UVLO 保护
  - UV 保护的断续模式
  - 逐周期 OC 保护
  - 1.6mm  $\times$  1.6mm SOT-563 封装
- 使用 TPS562242 并借助 WEBENCH® Power Designer 创建定制设计方案

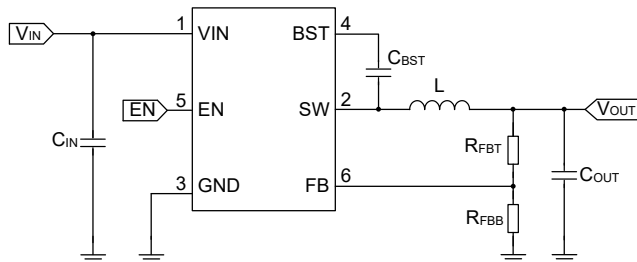

简化版应用

## 2 应用

- 电器、录像机
- WLAN、Wi-Fi 接入点、调制解调器 ( 电缆、DSL、GFAST )、小型企业路由器
- 电视、STB 和 DVR

## 3 说明

TPS562242 是一款简单、易用、高效率、高功率密度的同步降压转换器，输入电压范围为 3V 至 17V，在 0.8V 至 10V 的输出电压范围内，支持高达 2A 的持续输出电流。

TPS562242 采用 D-CAP3 控制模式提供快速瞬态响应并支持低 ESR 输出电容器，无需外部补偿。该器件支持高达 94% 的占空比运行。

TPS562242 在 Eco-mode 下运行，可在轻负载时保持高效率。该器件集成了全面的断续模式 OVP、OCP、UVLO、OTP 和 UVP 保护。

该器件采用 1.6mm  $\times$  1.6mm SOT-563 封装。额定结温范围为 -40°C 至 125°C。

### 封装信息

器件型号	封装 <sup>(1)</sup>	封装尺寸 (标称值)
TPS562242	DRL ( SOT-563 , 6 )	1.60mm $\times$ 1.60mm

(1) 如需了解所有可用封装，请参阅数据表末尾的可订购产品附录。

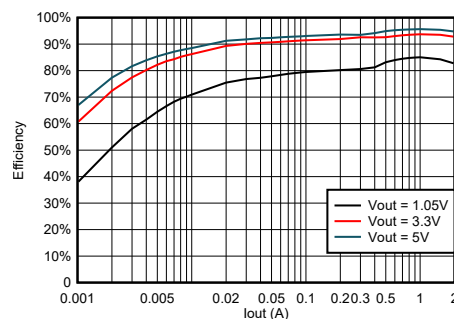

TPS562242 在  $V_{IN} = 12V$  时的效率



## Table of Contents

<b>1 特性</b> .....	<b>1</b>	7.4 Device Functional Modes.....	<b>11</b>
<b>2 应用</b> .....	<b>1</b>	<b>8 Application and Implementation</b> .....	<b>12</b>
<b>3 说明</b> .....	<b>1</b>	8.1 Application Information.....	<b>12</b>
<b>4 Revision History</b> .....	<b>2</b>	8.2 Typical Application.....	<b>12</b>
<b>5 Pin Configuration and Functions</b> .....	<b>3</b>	8.3 Power Supply Recommendations.....	<b>17</b>
<b>6 Specifications</b> .....	<b>4</b>	8.4 Layout.....	<b>17</b>
6.1 Absolute Maximum Ratings.....	<b>4</b>	<b>9 Device and Documentation Support</b> .....	<b>18</b>
6.2 ESD Ratings.....	<b>4</b>	9.1 Device Support.....	<b>18</b>
6.3 Recommended Operating Conditions.....	<b>4</b>	9.2 接收文档更新通知.....	<b>18</b>
6.4 Thermal Information.....	<b>5</b>	9.3 支持资源.....	<b>18</b>
6.5 Electrical Characteristics.....	<b>5</b>	9.4 Trademarks.....	<b>18</b>
6.6 Typical Characteristics.....	<b>7</b>	9.5 静电放电警告.....	<b>18</b>
<b>7 Detailed Description</b> .....	<b>9</b>	9.6 术语表.....	<b>18</b>
7.1 Overview.....	<b>9</b>	<b>10 Mechanical, Packaging, and Orderable</b>	<b>18</b>
7.2 Functional Block Diagram.....	<b>9</b>	<b>Information</b> .....	<b>18</b>
7.3 Feature Description.....	<b>10</b>		

## 4 Revision History

注：以前版本的页码可能与当前版本的页码不同

<b>Changes from Revision * (December 2022) to Revision A (May 2023)</b>	<b>Page</b>
• 将状态从“预告信息”更改为“量产数据” .....	<b>1</b>

## 5 Pin Configuration and Functions



图 5-1. 6-Pin SOT563 DRL Package (Top View)

表 5-1. Pin Functions

Pin		Type <sup>(1)</sup>	Description
Name	NO.		
VIN	1	P	Input voltage supply pin. Connect the input decoupling capacitors between VIN and GND.
SW	2	P	Switch node pin. Connect the output inductor to this pin.
GND	3	G	GND pin for the controller circuit and the internal circuitry.
BST	4	P	Connect a 100-nF ceramic capacitor from this pin to the SW pin or leave it floating.
EN	5	A	Enable control input. Driving EN high or leaving this pin floating enables the converter.
FB	6	A	Converter feedback input. Connect to output voltage with a feedback resistor divider.

(1) A = Analog, P = Power, G = Ground

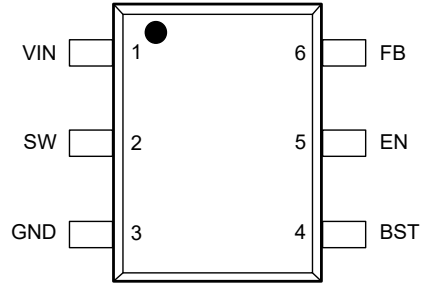
## 6 Specifications

### 6.1 Absolute Maximum Ratings

over operating free-air temperature range (unless otherwise noted)<sup>(1)</sup>

		MIN	MAX	UNIT
Pin voltage <sup>(2)</sup>	VIN	- 0.3	18	V
	FB, EN	- 0.3	6	V
	GND	- 0.3	0.3	V
	SW	- 2	18	V
	SW (transient < 20 ns)	- 5.5	20	V
	BST	- 2	18	V
	BST (transient < 20 ns)	- 5.5	20	V
Operating junction temperature, T <sub>J</sub>		- 40	150	°C
Storage temperature, T <sub>stg</sub>		- 55	150	°C

- (1) Operation outside the *Absolute Maximum Ratings* may cause permanent device damage. *Absolute Maximum Ratings* do not imply functional operation of the device at these or any other conditions beyond those listed under *Recommended Operating Conditions*. If used outside the *Recommended Operating Conditions* but within the *Absolute Maximum Ratings*, the device may not be fully functional, and this may affect device reliability, functionality, performance, and shorten the device lifetime.
- (2) All voltage values are with respect to the network ground pin.

### 6.2 ESD Ratings

		VALUE	UNIT
V <sub>(ESD)</sub> Electrostatic discharge	Human-body model (HBM), per ANSI/ESDA/JEDEC JS-001 <sup>(1)</sup> , all pins	±2000	V
	Charged-device model (CDM), per ANSI/ESDA/JEDEC JS-002 <sup>(2)</sup>	±500	

- (1) JEDEC document JEP155 states that 500-V HBM allows safe manufacturing with a standard ESD control process.
- (2) JEDEC document JEP157 states that 250-V CDM allows safe manufacturing with a standard ESD control process.

### 6.3 Recommended Operating Conditions

Over operating free-air temperature range (unless otherwise noted)

		MIN	NOM	MAX	UNIT
Pin voltage	VIN	3		17	V
	FB, EN	- 0.1		5.5	
	GND	- 0.1		0.1	
	SW	- 1		17	
	SW (transient < 20 ns)	- 5		18	
	BST	- 1		17	
	BST (transient < 20 ns)	- 5		18	
Output current	I <sub>OUT</sub>	0		2	A
Temperature	Operating junction temperature, T <sub>J</sub>	- 40		125	°C
	Storage temperature, T <sub>stg</sub>	- 40		150	

## 6.4 Thermal Information

THERMAL METRIC <sup>(1)</sup>		DRL (SOT-563)	UNIT
		6 PINS	
$R_{\theta JA}$ <sup>(2)</sup>	Junction-to-ambient thermal resistance	137.4	°C/W
$R_{\theta JA\_effective}$ <sup>(3)</sup>	Junction-to-ambient thermal resistance on EVM board	74	°C/W
$R_{\theta JC(top)}$	Junction-to-case (top) thermal resistance	58.8	°C/W
$R_{\theta JB}$	Junction-to-board thermal resistance	29.8	°C/W
$\psi_{JT}$	Junction-to-top characterization parameter	1.3	°C/W
$\psi_{JB}$	Junction-to-board characterization parameter	29.4	°C/W

- (1) For more information about traditional and new thermal metrics, see the [Semiconductor and IC Package Thermal Metrics](#) application report.
- (2) The value of  $R_{\theta JA}$  given in this table is only valid for comparison with other packages and can not be used for design purposes. These values were simulated on a standard JEDEC board. These values do not represent the performance obtained in an actual application.
- (3) This  $R_{\theta JA\_effective}$  is tested on TPS562242EVM board (2 layer, copper thickness is 2-oz) at  $V_{IN} = 12\text{ V}$ ,  $V_{OUT} = 5\text{ V}$ ,  $I_{OUT} = 2\text{ A}$ ,  $T_A = 25^\circ\text{C}$ .

## 6.5 Electrical Characteristics

$T_J = -40^\circ\text{C}$  to  $125^\circ\text{C}$ ,  $V_{IN} = 12\text{ V}$  (unless otherwise noted)

PARAMETER		TEST CONDITIONS	MIN	TYP	MAX	UNIT
<b>INPUT SUPPLY VOLTAGE</b>						
$V_{IN}$	Input voltage range	$V_{IN}$	3		17	V
$I_{VIN}$	VIN supply current	No load, $V_{EN} = 5\text{ V}$ , $V_{FB} = 0.85\text{ V}$ , non-switching, ECO version		100		$\mu\text{A}$
$I_{INSDN}$	VIN shutdown current	No load, $V_{EN} = 0\text{ V}$		5		$\mu\text{A}$
<b>UVLO</b>						
$V_{IN\_UVLO}$	Input undervoltage lockout threshold	Rising threshold	2.80	2.92	3.00	V
		Falling threshold	2.60	2.72	2.85	V
		Hysteresis		200		mV
<b>FEEDBACK VOLTAGE</b>						
$V_{REF}$	FB voltage	$T_J = 25^\circ\text{C}$	792	800	808	mV
		$T_J = -40^\circ\text{C}$ to $125^\circ\text{C}$	788	800	812	mV
<b>INTEGRATED POWER MOSFETS</b>						
$R_{DSON\_HS}$	High-side MOSFET on-resistance	$T_J = 25^\circ\text{C}$ , $V_{IN} \geq 5\text{ V}$		55.0		$\text{m}\Omega$
		$T_J = 25^\circ\text{C}$ , $V_{IN} = 3\text{ V}$ <sup>(1)</sup>		67.5		$\text{m}\Omega$
$R_{DSON\_LS}$	Low-side MOSFET on-resistance	$T_J = 25^\circ\text{C}$ , $V_{IN} \geq 5\text{ V}$		24.3		$\text{m}\Omega$
		$T_J = 25^\circ\text{C}$ , $V_{IN} = 3\text{ V}$		30.2		$\text{m}\Omega$
<b>SWITCHING FREQUENCY</b>						
$F_{sw}$	Switching frequency	$T_J = 25^\circ\text{C}$ , $V_{OUT} = 3.3\text{ V}$		1.4		MHz
$T_{ON(MIN)}$ <sup>(1)</sup>	Minimum on time			60		ns
$T_{OFF(MIN)}$ <sup>(1)</sup>	Minimum off time	$V_{FB} = 0.6\text{ V}$		110		ns
<b>LOGIC THRESHOLD</b>						
$V_{ENH}$	EN threshold high level	Rising enable threshold	1.14	1.17	1.22	V
$V_{ENL}$	EN threshold low level	Falling disable threshold	0.91	1.00	1.09	V
$V_{ENHYS}$	EN hysteresis	Hysteresis		170		mV
$I_{EN}$	EN pull up current	$V_{EN} = 1.0\text{ V}$		1.6		$\mu\text{A}$
<b>CURRENT LIMIT</b>						
$I_{OCL\_LS}$	Overcurrent threshold	Valley current set point	2.3	3.0	3.6	A

## 6.5 Electrical Characteristics (continued)

$T_J = -40^{\circ}\text{C}$  to  $125^{\circ}\text{C}$ ,  $V_{IN} = 12\text{ V}$  (unless otherwise noted)

PARAMETER		TEST CONDITIONS	MIN	TYP	MAX	UNIT
<b>SOFT START</b>						
$t_{SS}$	Internal soft start time			1.6		ms
<b>OUTPUT OVERVOLTAGE AND UNDERVOLTAGE PROTECTION</b>						
$V_{OVP}$	OVP trip threshold	$V_{FB}$ rising	110	115	120	%
$t_{OVPDLY}$	OVP prop deglitch			24		us
$V_{UVP}$	UVP trip threshold	$V_{FB}$ falling	55	60	65	%
$t_{UVPDLY}$	UVP prop deglitch			220		us
$t_{UVPEN}$	Hiccup enable delay time			14		ms
<b>THERMAL SHUTDOWN</b>						
$T_{SDN}^{(1)}$	Thermal shutdown threshold	Shutdown temperature		155		$^{\circ}\text{C}$
$T_{OTPHSY}^{(1)}$		Hysteresis		20		

(1) Specified by design

## 6.6 Typical Characteristics

$T_J = -40^{\circ}\text{C}$  to  $125^{\circ}\text{C}$ ,  $V_{IN} = 12\text{ V}$  (unless otherwise noted)



图 6-1. Quiescent Current



图 6-2. Enable On Threshold Voltage

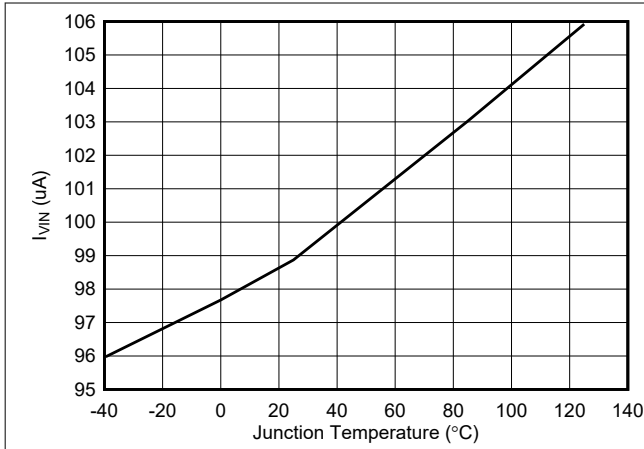

图 6-3. Enable Off Threshold Voltage

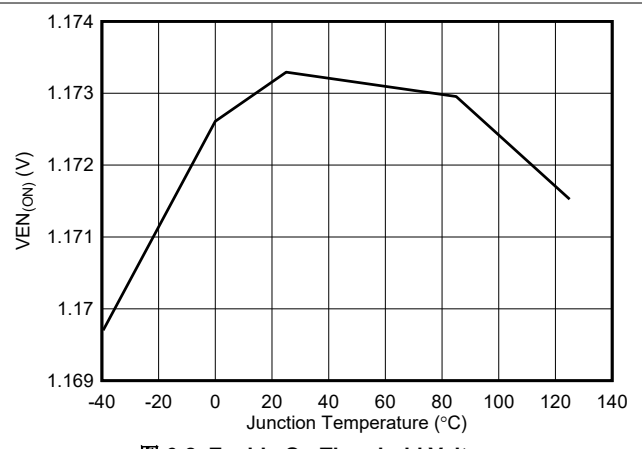

图 6-4. Low-Side  $R_{DS(ON)}$

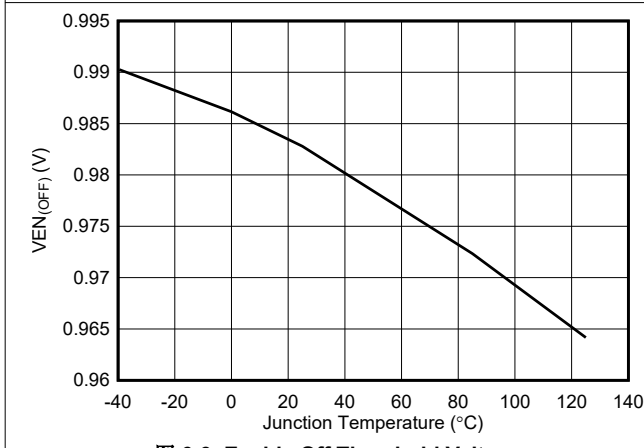

图 6-5. High-Side  $R_{DS(ON)}$

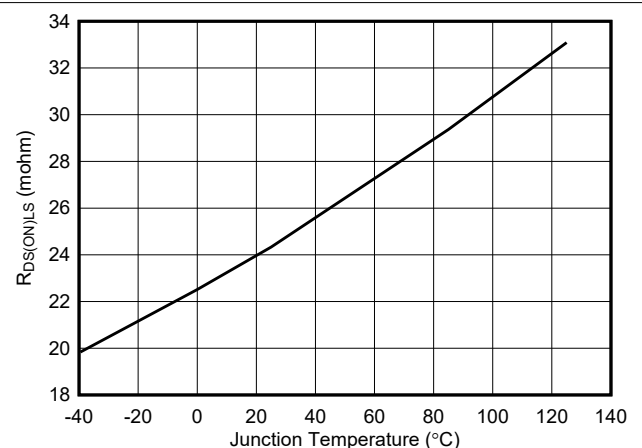

图 6-6.  $V_{REF}$  Voltage

## 6.6 Typical Characteristics (continued)

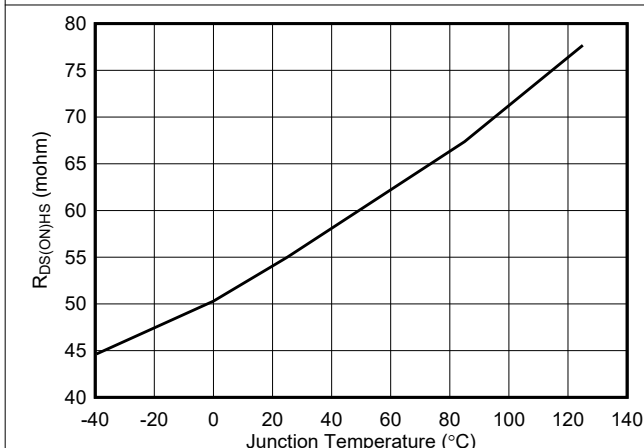
$T_J = -40^{\circ}\text{C}$  to  $125^{\circ}\text{C}$ ,  $V_{IN} = 12\text{ V}$  (unless otherwise noted)

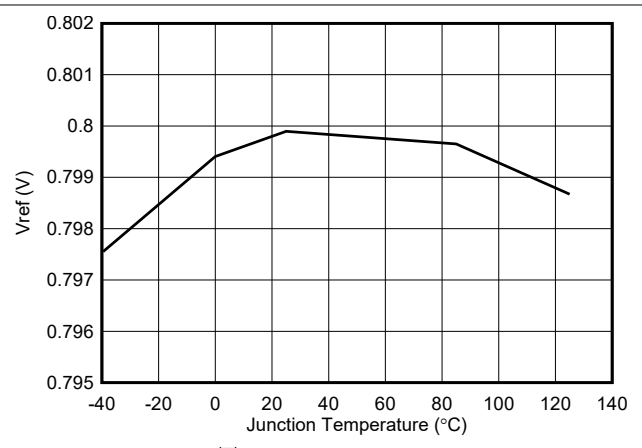

图 6-7. Efficiency at 0.8 V<sub>OUT</sub> with a 1-µH Inductor



图 6-8. Efficiency at 1.05 V<sub>OUT</sub> with a 1.2-µH Inductor

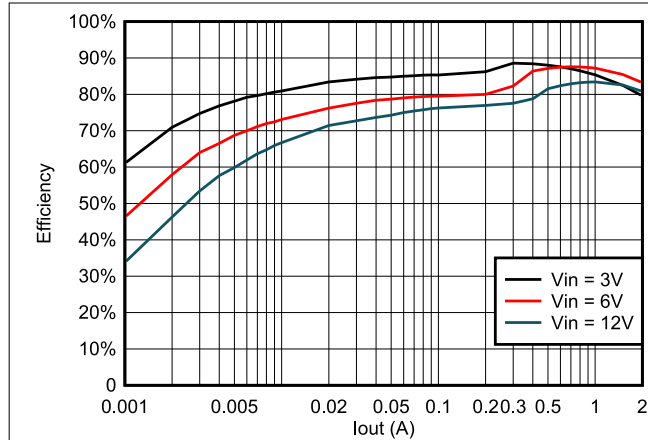

图 6-9. Efficiency at 3.3 V<sub>OUT</sub> with a 2.2-µH Inductor

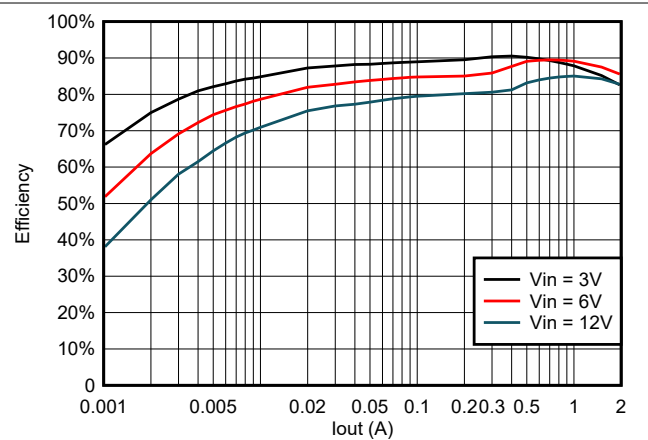

图 6-10. Efficiency at 5 V<sub>OUT</sub> with a 3.3-µH Inductor

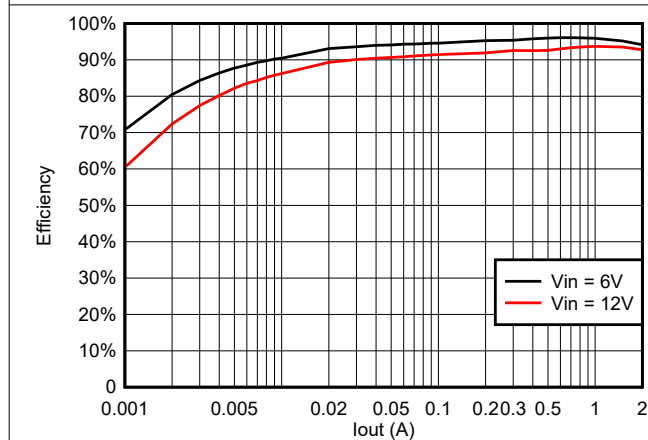

图 6-11. Frequency vs Input Voltage, I<sub>OUT</sub> = 2 A

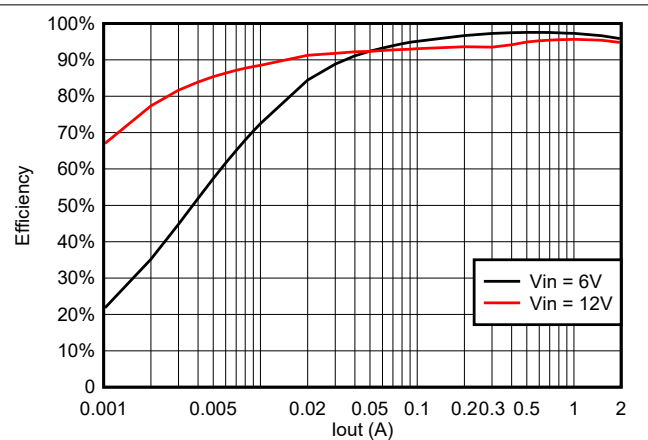

图 6-12. Frequency vs Loading, V<sub>IN</sub> = 12 V

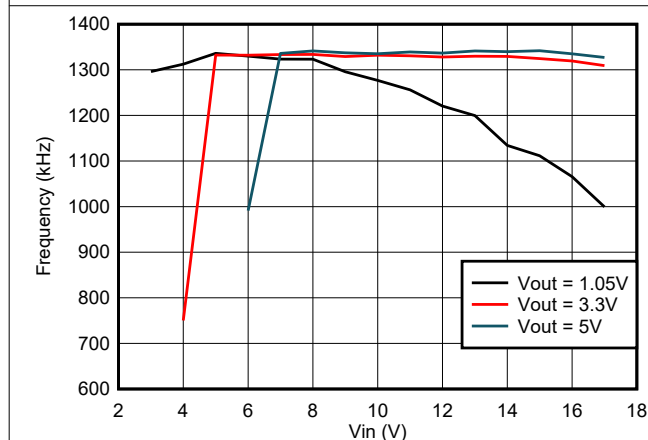

## 7 Detailed Description

### 7.1 Overview

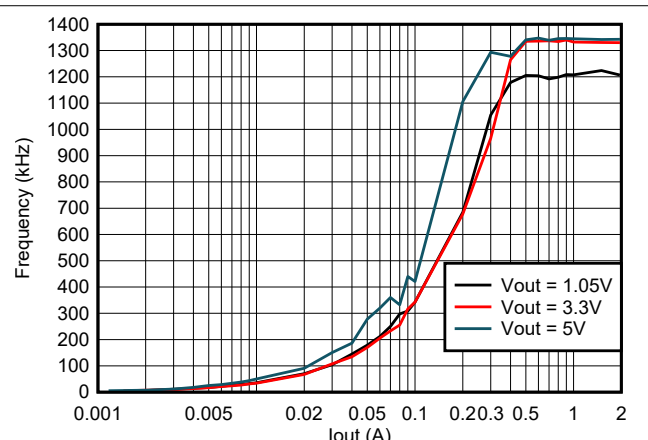
The TPS562242 is a 2-A integrated FET synchronous buck converter that operates from 3-V to 17-V input voltage and 0.8-V to 10-V output voltage. The device employs a D-CAP3 control mode that provides fast transient response with no external compensation components and an accurate feedback voltage. The proprietary D-CAP3 control mode enables low external component count, ease of design, and optimization of the power design for cost, size, and efficiency. The topology provides a seamless transition between CCM operating mode at higher load condition and DCM operation mode at lighter load condition.

The Eco-mode version allows the TPS562242 to maintain high efficiency at light load. The TPS562242 is able to adapt to both low equivalent series resistance (ESR) output capacitors such as POSCAP or SP-CAP, and ultra-low ESR ceramic capacitors.

### 7.2 Functional Block Diagram

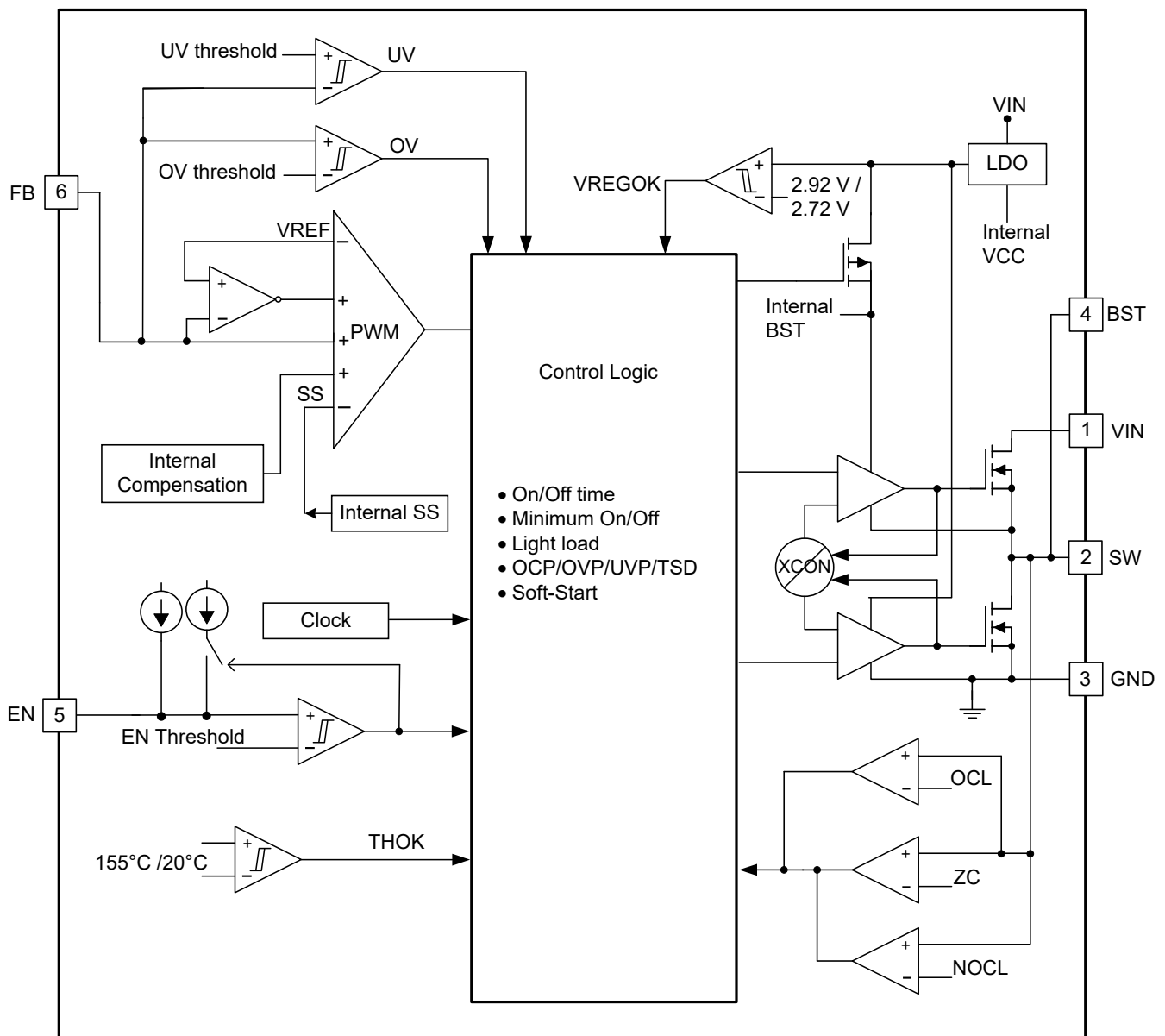

## 7.3 Feature Description

### 7.3.1 PWM Operation and D-CAP3™ Control Mode

The main control loop of the buck is an adaptive on-time pulse width modulation (PWM) controller that supports a proprietary D-CAP3 control mode. The D-CAP3 control mode combines adaptive on-time control with an internal compensation circuit for pseudo-fixed frequency and low external component count configuration with both low-ESR and ceramic output capacitors. The device is stable even with virtually no ripple at the output. The TPS562242 also includes an error amplifier that makes the output voltage very accurate.

At the beginning of each cycle, the high-side MOSFET is turned on. This MOSFET is turned off after an internal one-shot timer expires. This one-shot duration is set proportional to the output voltage,  $V_{OUT}$ , and is inversely proportional to the converter input voltage,  $V_{IN}$ , to maintain a pseudo-fixed frequency over the input voltage range, hence, it is called adaptive on-time control. The one-shot timer is reset and the high-side MOSFET is turned on again when the feedback voltage falls below the reference voltage. An internal ripple generation circuit is added to reference voltage to emulate the output ripple, enabling the use of very low-ESR output capacitors such as multi-layered ceramic caps (MLCC). No external current sense network or loop compensation is required for D-CAP3 control mode.

### 7.3.2 Eco-mode Control

The TPS562242 is designed with advanced Eco-mode to maintain high light-load efficiency. As the output current decreases from heavy load condition, the inductor current is also reduced and eventually comes to point that its ripple valley touches zero level, which is the boundary between continuous conduction and discontinuous conduction mode. The rectifying MOSFET is turned off when the zero inductor current is detected. As the load current further decreases, the converter runs into discontinuous conduction mode. The on time is kept almost the same as it was in continuous conduction mode so that it takes longer time to discharge the output capacitor with smaller load current to the level of the reference voltage. This makes the switching frequency lower, proportional to the load current, and keeps the light load efficiency high. Use the below equation to calculate the transition point to the light load operation  $I_{OUT(LL)}$  current.

$$I_{OUT(LL)} = \frac{1}{2 \times L \times f_{SW}} \times \frac{(V_{IN} - V_{OUT}) \times V_{OUT}}{V_{IN}} \quad (1)$$

### 7.3.3 Soft Start and Prebiased Soft Start

The TPS562242 has an internal fixed 1.6-ms soft-start time. The internal soft-start function begins ramping up the reference voltage to the PWM comparator during start-up period.

If the output capacitor is prebiased at start-up, the devices initiate switching and start ramping up only after the internal reference voltage becomes higher than the feedback voltage,  $V_{FB}$ . This scheme makes sure that the converter ramps up smoothly into the regulation point.

### 7.3.4 Overvoltage Protection

The TPS562242 has the overvoltage protection feature. When the output voltage becomes higher than the OVP threshold, the OVP is triggered with a 24- $\mu$ s deglitch time. Both the high-side MOSFET and the low-side MOSFET drivers are turned off. When the overvoltage condition is removed, the device returns to switching.

### 7.3.5 Large Duty Operation

The TPS562242 can support large duty operations up to 94% by smoothly dropping down the switching frequency. When  $V_{IN} / V_{OUT} < 1.6$  and  $V_{FB}$  is lower than internal  $V_{REF}$ , the switching frequency is allowed to smoothly drop to make  $t_{ON}$  extended to implement the large duty operation and improve the performance of the load transient. Please refer frequency test waveform in [Figure 6-11](#). The minimum switching frequency is limited to approximately 700 kHz.

### 7.3.6 Current Protection and Undervoltage Protection

The output overcurrent limit (OCL) is implemented using a cycle-by-cycle valley detect control circuit. The switch current is monitored during the off state by measuring the low-side FET drain-to-source voltage. This voltage is proportional to the switch current. To improve accuracy, the voltage sensing is temperature compensated.

During the on time of the high-side FET switch, the switch current increases at a linear rate determined by the following:

- $V_{IN}$
- $V_{OUT}$
- On-time
- Output inductor value

During the on time of the low-side FET switch, this current decreases linearly. The average value of the switch current is the load current,  $I_{OUT}$ . If the monitored valley current is above the OCL level, the converter maintains a low-side FET on and delays the creation of a new set pulse, even the voltage feedback loop requires one, until the current level becomes OCL level or lower. In subsequent switching cycles, the on time is set to a fixed value and the current is monitored in the same manner.

There are some important considerations for this type of overcurrent protection. The load current is higher than the overcurrent threshold by one half of the peak-to-peak inductor ripple current. Also, when the current is being limited, the output voltage tends to fall as the demanded load current can be higher than the current available from the converter, which can cause the output voltage to fall. When the FB voltage falls below the UVP threshold voltage, the UVP comparator detects it and the device shuts down after the UVP delay time (typically 220  $\mu$ s) and restarts after the hiccup wait time (typically 14 ms). After the device enters the hiccup cycling, the hiccup on time is typically 2.2 ms.

When the overcurrent condition is removed, the output voltage returns to the regulated value.

### 7.3.7 Undervoltage Lockout (UVLO) Protection

UVLO protection monitors the internal regulator voltage. When the voltage is lower than UVLO threshold voltage, the device is shut off. This protection is a non-latch protection.

### 7.3.8 Thermal Shutdown

The device monitors the temperature of itself. If the temperature exceeds the threshold value, the device is shut off. This protection is a non-latch protection.

## 7.4 Device Functional Modes

### 7.4.1 Eco-mode Operation

The TPS562242 operates in Eco-mode, which maintains high efficiency at light loading. As the output current decreases from heavy load conditions, the inductor current is also reduced and eventually comes to a point where the rippled valley touches zero level, which is the boundary between continuous conduction and discontinuous conduction mode. The rectifying MOSFET is turned off when the zero inductor current is detected. As the load current further decreases, the converter runs into discontinuous conduction mode. The on time is kept almost the same as it was in continuous conduction mode so that it takes longer time to discharge the output capacitor with smaller load current to the level of the reference voltage. This action makes the switching frequency lower, proportional to the load current, and keeps the light load efficiency high.

## 8 Application and Implementation

### 备注

Information in the following applications sections is not part of the TI component specification, and TI does not warrant its accuracy or completeness. TI's customers are responsible for determining suitability of components for their purposes, as well as validating and testing their design implementation to confirm system functionality.

### 8.1 Application Information

The device is a typical buck DC/DC converter that is typically used to convert a higher DC voltage to a lower DC voltage with a maximum available output current of 2 A. The following design procedure can be used to select component values for TPS562242. Alternately, the WEBENCH Power Designer software can be used to generate a complete design. The WEBENCH Power Designer software uses an iterative design procedure and accesses a comprehensive database of components when generating a design. This section presents a simplified discussion of the design process.

### 8.2 Typical Application

The application schematic in 图 8-1 was developed to meet the requirements in 表 8-1. This circuit is available as the evaluation module (EVM). The sections provide the design procedure.

图 8-1 shows the TPS562242 5-V to 17-V input, 1.05-V output converter schematic.



图 8-1. Schematic

#### 8.2.1 Design Requirements

表 8-1 shows the design parameters for this application.

表 8-1. Design Parameters

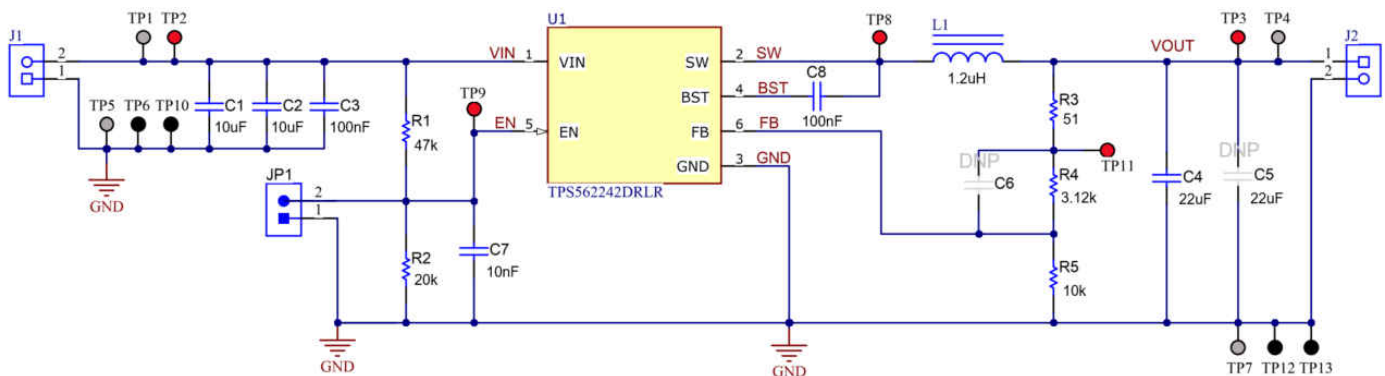
Parameter	Conditions	MIN	TYP	MAX	Unit
$V_{OUT}$	Output voltage		1.05		V
$I_{OUT}$	Output current		2		A
$\Delta V_{OUT}$	Transient response	0.2-A - 1.8-A load step, 0.8-A/μs slew rate		$\pm 2\% \times V_{OUT}$	V
$V_{IN}$	Input voltage	5	12	17	V
$V_{OUT(ripple)}$	Output voltage ripple	CCM condition		6	mV
$F_{SW}$	Switching frequency			1.4	MHz
$T_A$	Ambient temperature			25	°C

## 8.2.2 Detailed Design Procedure

### 8.2.2.1 Custom Design with WEBENCH® Tools

[Click here](#) to create a custom design using the TPS562242 device with the WEBENCH® Power Designer.

1. Start by entering the input voltage ( $V_{IN}$ ), output voltage ( $V_{OUT}$ ), and output current ( $I_{OUT}$ ) requirements.
2. Optimize the design for key parameters such as efficiency, footprint, and cost using the optimizer dial.
3. Compare the generated design with other possible solutions from Texas Instruments.

The WEBENCH Power Designer provides a customized schematic along with a list of materials with real-time pricing and component availability.

In most cases, these actions are available:

- Run electrical simulations to see important waveforms and circuit performance
- Run thermal simulations to understand board thermal performance
- Export customized schematic and layout into popular CAD formats
- Print PDF reports for the design, and share the design with colleagues

Get more information about WEBENCH tools at [www.ti.com/WEBENCH](http://www.ti.com/WEBENCH).

### 8.2.2.2 Output Voltage Resistors Selection

The output voltage is set with a resistor divider from the output node to the FB pin. TI recommends using 1% tolerance or better divider resistors. Start by using [方程式 2](#) to calculate  $V_{OUT}$ .

To improve efficiency at very light loads, consider using larger value resistors. If the values are too high, the regulator is more susceptible to noise and voltage errors from the FB input current are noticeable. Use a 10-k $\Omega$  resistor for  $R_5$  to start the design.

$$V_{OUT} = 0.8 \times \left( 1 + \frac{R_4}{R_5} \right) \quad (2)$$

### 8.2.2.3 Output Filter Selection

The LC filter used as the output filter has a double pole at [方程式 3](#). In this equation,  $C_{OUT}$  uses its effective value after derating, not its nominal value.

$$f_P = \frac{1}{2\pi\sqrt{L_{OUT} \times C_{OUT}}} \quad (3)$$

For any control topology that is compensated internally, there is a range of the output filter it can support. At low frequency, the overall loop gain is set by the output set-point resistor divider network and the internal gain of the device. The low frequency phase is 180°. At the output filter pole frequency, the gain rolls off at a -40 dB per decade rate and the phase drops has a 180 degree drop. The internal ripple generation network introduces a high-frequency zero that reduces the gain roll off from -40 dB to -20 dB per decade and leads the 90 degree phase boost. The internal ripple injection high-frequency zero is about 156 kHz. TI recommends the inductor and capacitor selected for the output filter such that the double pole is located approximately 40 kHz, so that the phase boost provided by this high-frequency zero provides adequate phase margin for the stability requirement. The crossover frequency of the overall system is usually targeted to be less than one-third of the switching frequency ( $f_{SW}$ ). For high output voltage condition, TI recommends to use 10-100pF feedforward capacitor for enough phase margin.

表 8-2. Recommended Component Values

Output Voltage (V)	R4 (kΩ)	R5 (kΩ)	Typical L1 (μH)	Typical C <sub>OUT</sub> (μF)	Typical C <sub>OUT</sub> (μF) Nominal Value Range	Typical C <sub>OUT</sub> Category	Typical C6 (pF)
0.8	0	10.0	1	44	22-88	MLCC, 0805, 10V	—
1.05	3.12	10.0	1.2	22	22-66	MLCC, 0805, 10V	—
3.3	94.2	30.0	2.2	22	22-88	MLCC, 0805, 10V	33
5	158.0	30.0	3.3	22	22-88	MLCC, 0805, 10V	33
10	345.0	30.0	4.7	44	44-88	MLCC, 0805, 16V	47

The inductor peak-to-peak ripple current, peak current, and RMS current are calculated using 方程式 4, 方程式 5, and 方程式 6. Generally, TI recommends the peak-to-peak ripple current to be 20% - 50% of output average current for a comprehensive benefit of efficiency and inductor volume. The inductor saturation current rating must be greater than the calculated peak current and the RMS or heating current rating must be greater than the calculated RMS current.

$$I_{P-P} = \frac{V_{OUT}}{V_{IN(MAX)}} \times \frac{V_{IN(MAX)} - V_{OUT}}{L_O \times f_{SW}} \quad (4)$$

$$I_{PEAK} = I_O + \frac{I_{P-P}}{2} \quad (5)$$

$$I_{LO(RMS)} = \sqrt{I_O^2 + \frac{1}{12} I_{P-P}^2} \quad (6)$$

For this design example, the calculated peak current is 2.3 A and the calculated RMS current is 2.00 A. The inductor used is 74438357012 with 7-A rated current and 8.8-A saturation current.

The capacitor value and ESR determines the amount of output voltage ripple. The TPS562242 are intended for use with ceramic or other low-ESR capacitors. Use 方程式 7 to determine the required RMS current rating for the output capacitor.

$$I_{CO(RMS)} = \frac{V_{OUT} \times (V_{IN} - V_{OUT})}{\sqrt{12} \times V_{IN} \times L_O \times f_{SW}} \quad (7)$$

For this design, one MuRata GRM21BR61A226ME44L 22-μF output capacitors are used. The typical ESR is 2 mΩ each. The calculated RMS current is 0.17 A and each output capacitor is rated for 4 A.

#### 8.2.2.4 Input Capacitor Selection

The TPS562242 requires an input decoupling capacitor and a bulk capacitor is needed depending on the application. TI recommends a ceramic capacitor over 10 μF for the decoupling capacitor. TI recommends an additional 0.1-μF capacitor from the VIN pin to ground to provide high frequency filtering. The capacitor voltage rating must be greater than the maximum input voltage.

#### 8.2.2.5 Bootstrap Capacitor Selection

The real BST is integrated inside by using a special charging high side FET circuit. A typical 0.1-μF ceramic capacitor can be connected between the BST to SW pin or leave floating.

### 8.2.3 Application Curves

The following data is tested with  $V_{IN} = 12\text{ V}$ ,  $V_{OUT} = 1.05\text{ V}$ ,  $T_A = 25^\circ\text{C}$ , unless otherwise specified.



图 8-2. Efficiency vs Loading



图 8-3. Frequency vs Loading

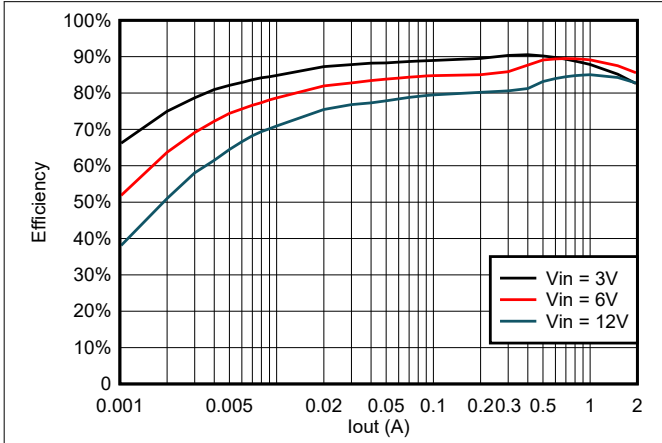

图 8-4. Load Regulation vs Loading

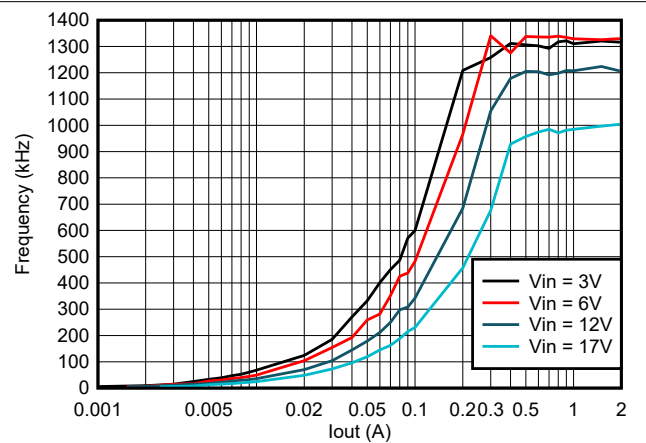

图 8-5. Line Regulation vs  $V_{IN}$

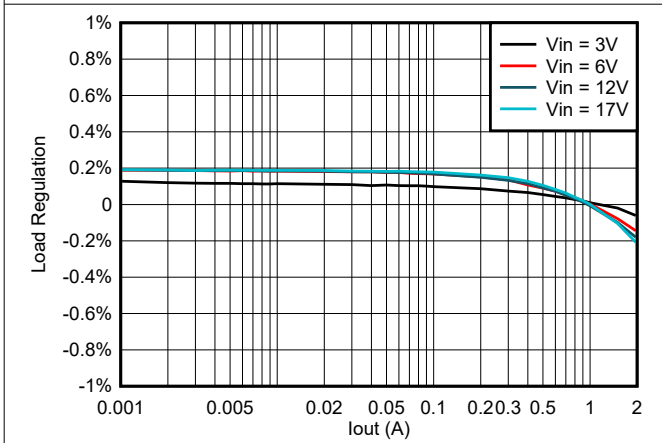

图 8-6. Output Voltage Ripple with 0.01-A Loading

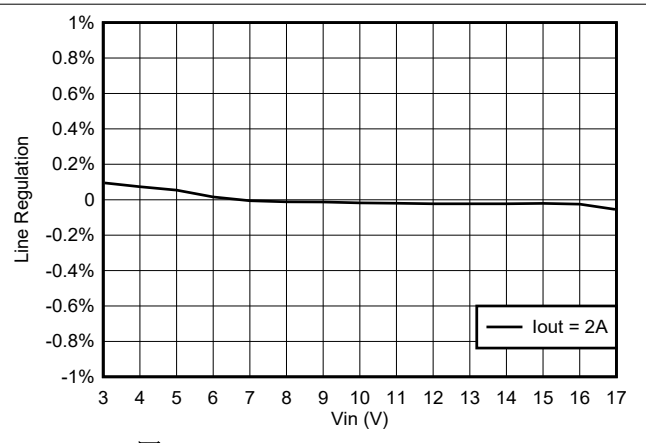

图 8-7. Output Voltage Ripple with 2-A Loading

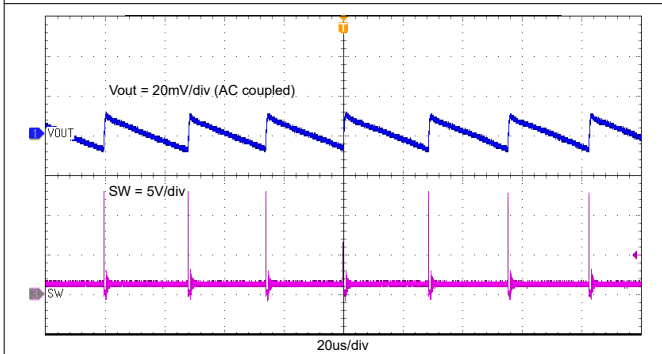

图 8-8. Start-up Through EN,  $I_{OUT} = 2\text{ A}$

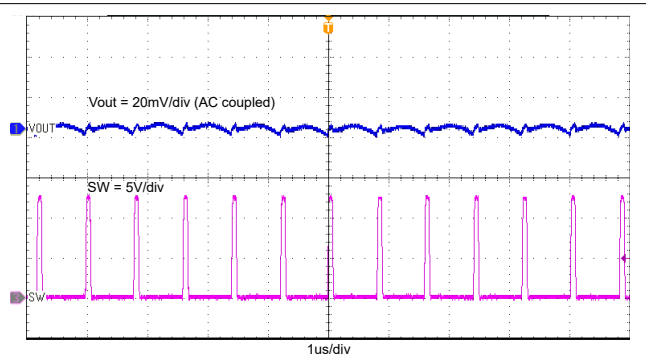

图 8-9. Shutdown Through EN,  $I_{OUT} = 2\text{ A}$

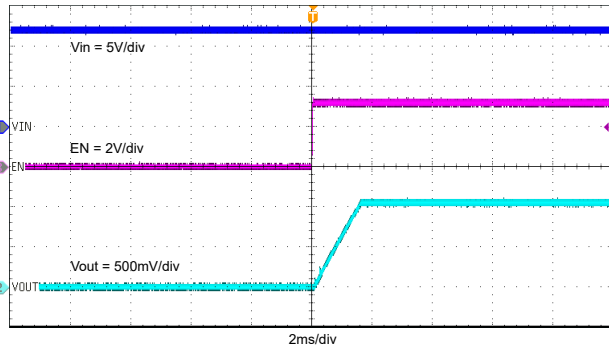

图 8-10. Start-up with  $V_{IN}$  Rising,  $I_{OUT} = 2\text{ A}$

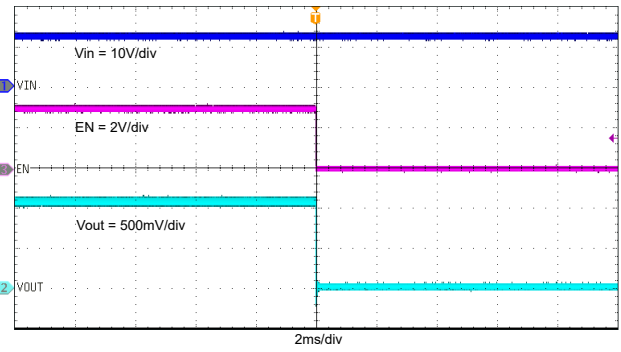

图 8-11. Shutdown with  $V_{IN}$  Falling,  $I_{OUT} = 2\text{ A}$

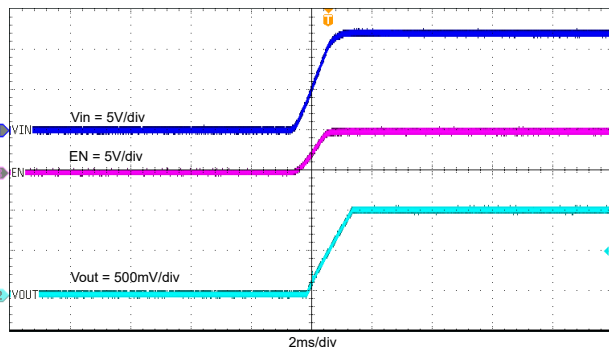

图 8-12. Transient Response with 0.2 A to 1.8 A

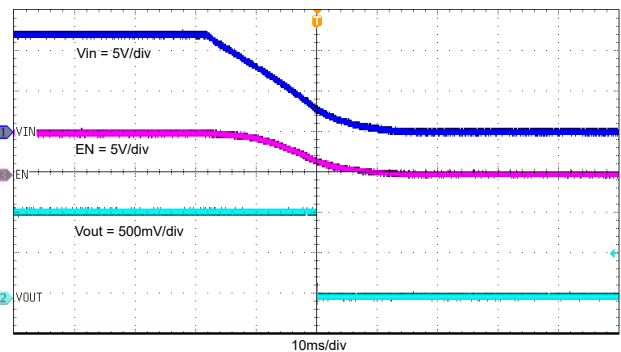

图 8-13. Transient Response with 0.01 A to 2 A

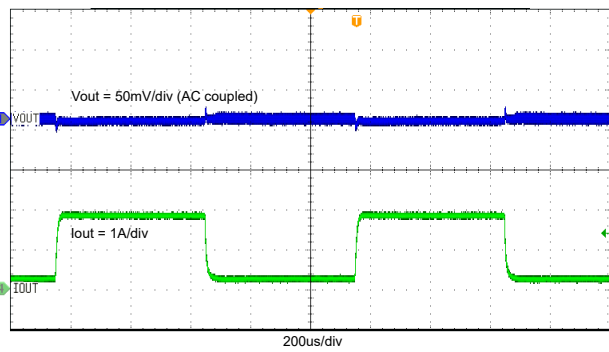

图 8-14. Normal Operation to Output Hard Short

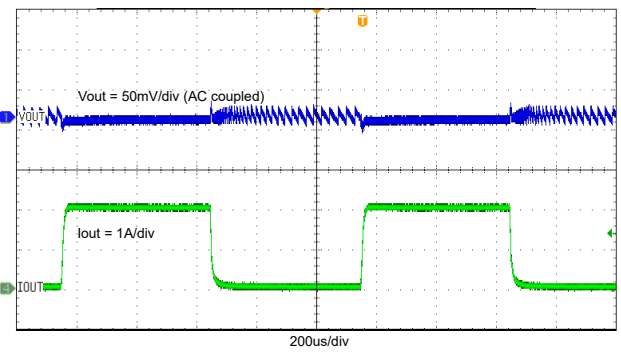

图 8-15. Output Hard Short Hiccup

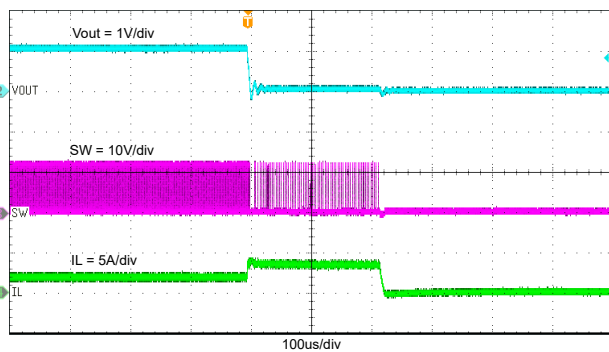

### 8.3 Power Supply Recommendations

The TPS562242 are designed to operate from input supply voltages in the range of 3 V to 17 V. Buck converters require the input voltage to be higher than the output voltage for proper operation.

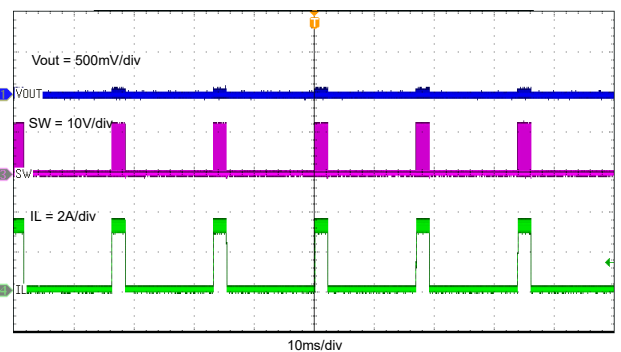
### 8.4 Layout

#### 8.4.1 Layout Guidelines

- Keep VIN and GND traces as wide as possible to reduce trace impedance. The wide areas are also an advantage from the view point of heat dissipation.
- Place the input capacitor and output capacitor as close to the device as possible to minimize trace impedance.
- Provide sufficient vias for the input capacitor and output capacitor.
- Keep the SW trace as physically short and wide as practical to minimize radiated emissions.
- Do not allow switching current to flow under the device.
- Connect a separate VOUT path to the upper feedback resistor.
- Make a Kelvin connection to the GND pin for the feedback path.
- Place a voltage feedback loop away from the high-voltage switching trace, and preferably has ground shield.
- Make the trace of the FB node as small as possible to avoid noise coupling.
- Make the GND trace between the output capacitor and the GND pin as wide as possible to minimize its trace impedance.

#### 8.4.2 Layout Example

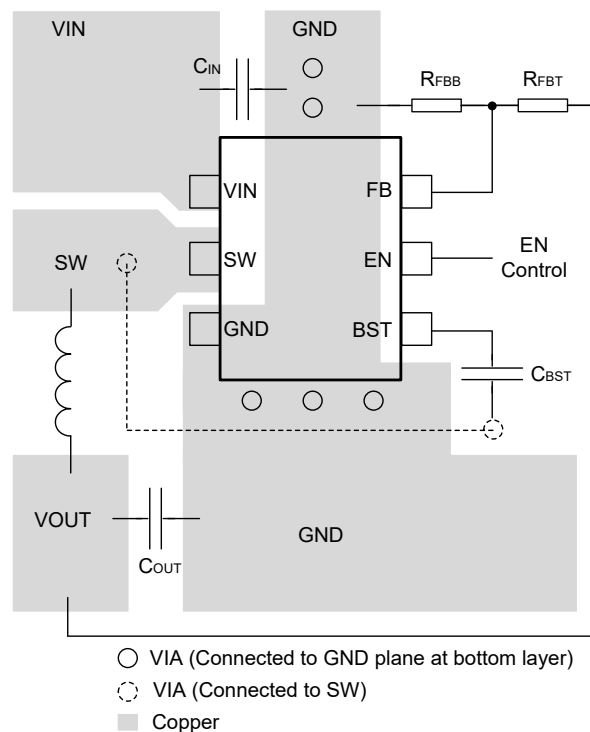

**图 8-16. Suggested Layout**

## 9 Device and Documentation Support

### 9.1 Device Support

#### 9.1.1 Development Support

##### 9.1.1.1 Custom Design with WEBENCH® Tools

Click [here](#) to create a custom design using the TPS562242 device with the WEBENCH® Power Designer.

1. Start by entering the input voltage ( $V_{IN}$ ), output voltage ( $V_{OUT}$ ), and output current ( $I_{OUT}$ ) requirements.
2. Optimize the design for key parameters such as efficiency, footprint, and cost using the optimizer dial.
3. Compare the generated design with other possible solutions from Texas Instruments.

The WEBENCH Power Designer provides a customized schematic along with a list of materials with real-time pricing and component availability.

In most cases, these actions are available:

- Run electrical simulations to see important waveforms and circuit performance
- Run thermal simulations to understand board thermal performance
- Export customized schematic and layout into popular CAD formats
- Print PDF reports for the design, and share the design with colleagues

Get more information about WEBENCH tools at [www.ti.com/WEBENCH](http://www.ti.com/WEBENCH).

### 9.2 接收文档更新通知

要接收文档更新通知，请导航至 [ti.com](http://ti.com) 上的器件产品文件夹。点击 [订阅更新](#) 进行注册，即可每周接收产品信息更改摘要。有关更改的详细信息，请查看任何已修订文档中包含的修订历史记录。

### 9.3 支持资源

TI E2E™ 支持论坛是工程师的重要参考资料，可直接从专家获得快速、经过验证的解答和设计帮助。搜索现有解答或提出自己的问题可获得所需的快速设计帮助。

链接的内容由各个贡献者“按原样”提供。这些内容并不构成 TI 技术规范，并且不一定反映 TI 的观点；请参阅 TI 的《使用条款》。

### 9.4 Trademarks

D-CAP3™ and TI E2E™ are trademarks of Texas Instruments.

WEBENCH® is a registered trademark of Texas Instruments.

所有商标均为其各自所有者的财产。

### 9.5 静电放电警告



静电放电 (ESD) 会损坏这个集成电路。德州仪器 (TI) 建议通过适当的预防措施处理所有集成电路。如果不遵守正确的处理和安装程序，可能会损坏集成电路。

ESD 的损坏小至导致微小的性能降级，大至整个器件故障。精密的集成电路可能更容易受到损坏，这是因为非常细微的参数更改都可能会导致器件与其发布的规格不相符。

### 9.6 术语表

**TI 术语表** 本术语表列出并解释了术语、首字母缩略词和定义。

## 10 Mechanical, Packaging, and Orderable Information

The following pages include mechanical, packaging, and orderable information. This information is the most current data available for the designated devices. This data is subject to change without notice and revision of this document. For browser-based versions of this data sheet, refer to the left-hand navigation.

**PACKAGING INFORMATION**

Orderable Device	Status (1)	Package Type	Package Drawing	Pins	Package Qty	Eco Plan (2)	Lead finish/ Ball material (6)	MSL Peak Temp (3)	Op Temp (°C)	Device Marking (4/5)	Samples
TPS562242DRLR	ACTIVE	SOT-5X3	DRL	6	4000	RoHS & Green	Call TI   SN	Level-1-260C-UNLIM	-40 to 125	2242	Samples

(1) The marketing status values are defined as follows:

**ACTIVE:** Product device recommended for new designs.

**LIFEBUY:** TI has announced that the device will be discontinued, and a lifetime-buy period is in effect.

**NRND:** Not recommended for new designs. Device is in production to support existing customers, but TI does not recommend using this part in a new design.

**PREVIEW:** Device has been announced but is not in production. Samples may or may not be available.

**OBSELETE:** TI has discontinued the production of the device.

(2) **RoHS:** TI defines "RoHS" to mean semiconductor products that are compliant with the current EU RoHS requirements for all 10 RoHS substances, including the requirement that RoHS substance do not exceed 0.1% by weight in homogeneous materials. Where designed to be soldered at high temperatures, "RoHS" products are suitable for use in specified lead-free processes. TI may reference these types of products as "Pb-Free".

**RoHS Exempt:** TI defines "RoHS Exempt" to mean products that contain lead but are compliant with EU RoHS pursuant to a specific EU RoHS exemption.

**Green:** TI defines "Green" to mean the content of Chlorine (Cl) and Bromine (Br) based flame retardants meet JS709B low halogen requirements of <=1000ppm threshold. Antimony trioxide based flame retardants must also meet the <=1000ppm threshold requirement.

(3) MSL, Peak Temp. - The Moisture Sensitivity Level rating according to the JEDEC industry standard classifications, and peak solder temperature.

(4) There may be additional marking, which relates to the logo, the lot trace code information, or the environmental category on the device.

(5) Multiple Device Markings will be inside parentheses. Only one Device Marking contained in parentheses and separated by a "~" will appear on a device. If a line is indented then it is a continuation of the previous line and the two combined represent the entire Device Marking for that device.

(6) Lead finish/Ball material - Orderable Devices may have multiple material finish options. Finish options are separated by a vertical ruled line. Lead finish/Ball material values may wrap to two lines if the finish value exceeds the maximum column width.

**Important Information and Disclaimer:**The information provided on this page represents TI's knowledge and belief as of the date that it is provided. TI bases its knowledge and belief on information provided by third parties, and makes no representation or warranty as to the accuracy of such information. Efforts are underway to better integrate information from third parties. TI has taken and continues to take reasonable steps to provide representative and accurate information but may not have conducted destructive testing or chemical analysis on incoming materials and chemicals. TI and TI suppliers consider certain information to be proprietary, and thus CAS numbers and other limited information may not be available for release.

In no event shall TI's liability arising out of such information exceed the total purchase price of the TI part(s) at issue in this document sold by TI to Customer on an annual basis.

# DRL0006A



# PACKAGE OUTLINE

## SOT - 0.6 mm max height

PLASTIC SMALL OUTLINE

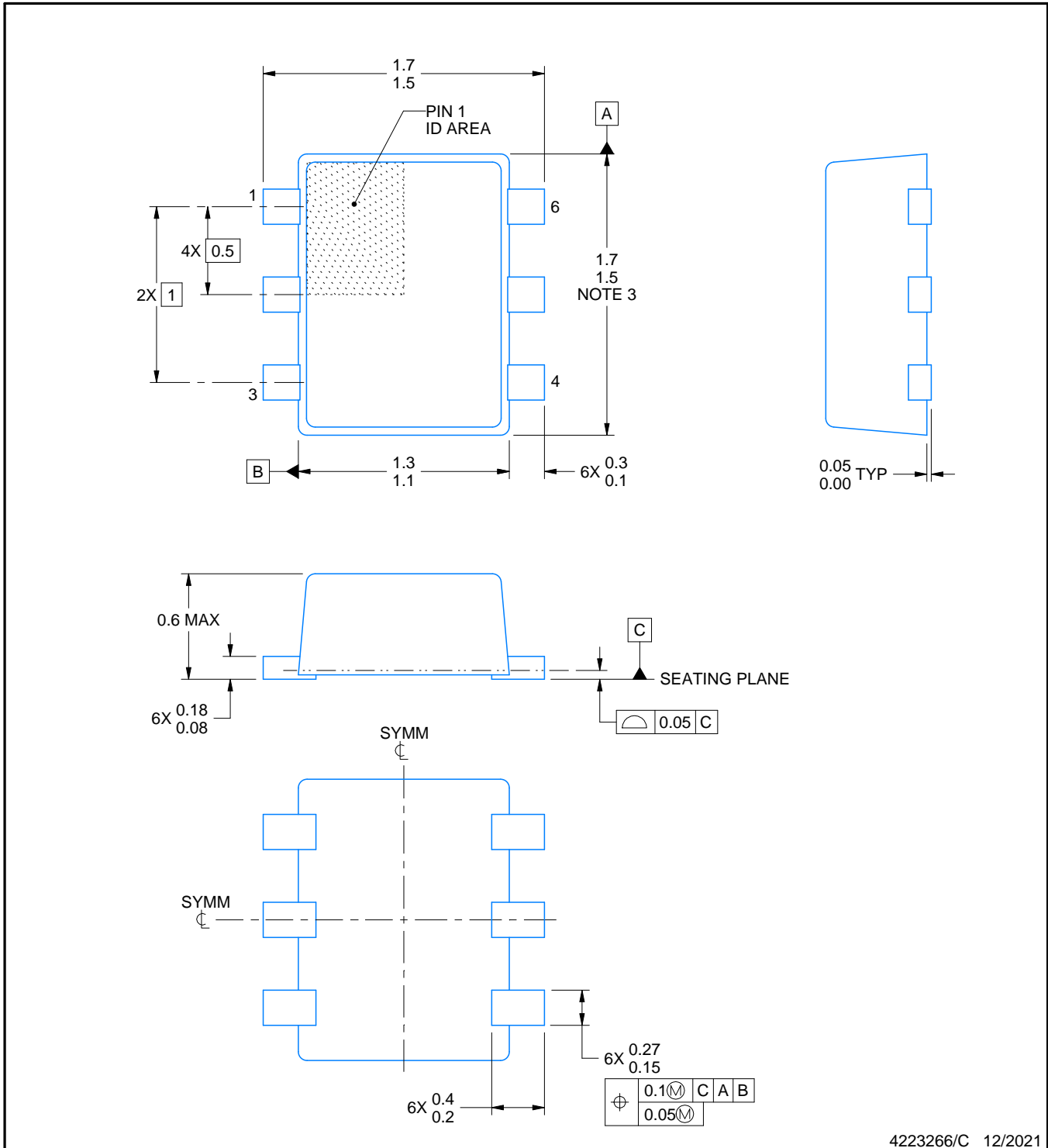

4223266/C 12/2021

### NOTES:

1. All linear dimensions are in millimeters. Any dimensions in parenthesis are for reference only. Dimensioning and tolerancing per ASME Y14.5M.
2. This drawing is subject to change without notice.
3. This dimension does not include mold flash, protrusions, or gate burrs. Mold flash, protrusions, or gate burrs shall not exceed 0.15 mm per side.
4. Reference JEDEC registration MO-293 Variation UAAD

# EXAMPLE BOARD LAYOUT

DRL0006A

SOT - 0.6 mm max height

PLASTIC SMALL OUTLINE



LAND PATTERN EXAMPLE  
SCALE:30X



SOLDERMASK DETAILS

4223266/C 12/2021

NOTES: (continued)

5. Publication IPC-7351 may have alternate designs.
6. Solder mask tolerances between and around signal pads can vary based on board fabrication site.
7. Land pattern design aligns to IPC-610, Bottom Termination Component (BTC) solder joint inspection criteria.

# EXAMPLE STENCIL DESIGN

DRL0006A

SOT - 0.6 mm max height

PLASTIC SMALL OUTLINE



SOLDER PASTE EXAMPLE  
BASED ON 0.1 mm THICK STENCIL  
SCALE:30X

4223266/C 12/2021

NOTES: (continued)

8. Laser cutting apertures with trapezoidal walls and rounded corners may offer better paste release. IPC-7525 may have alternate design recommendations.
9. Board assembly site may have different recommendations for stencil design.

## 重要声明和免责声明

TI“按原样”提供技术和可靠性数据（包括数据表）、设计资源（包括参考设计）、应用或其他设计建议、网络工具、安全信息和其他资源，不保证没有瑕疵且不做任何明示或暗示的担保，包括但不限于对适销性、某特定用途方面的适用性或不侵犯任何第三方知识产权的暗示担保。

这些资源可供使用 TI 产品进行设计的熟练开发人员使用。您将自行承担以下全部责任：(1) 针对您的应用选择合适的 TI 产品，(2) 设计、验证并测试您的应用，(3) 确保您的应用满足相应标准以及任何其他功能安全、信息安全、监管或其他要求。

这些资源如有变更，恕不另行通知。TI 授权您仅可将这些资源用于研发本资源所述的 TI 产品的应用。严禁对这些资源进行其他复制或展示。您无权使用任何其他 TI 知识产权或任何第三方知识产权。您应全额赔偿因在这些资源的使用中对 TI 及其代表造成的任何索赔、损害、成本、损失和债务，TI 对此概不负责。

TI 提供的产品受 [TI 的销售条款](#) 或 [ti.com](#) 上其他适用条款/TI 产品随附的其他适用条款的约束。TI 提供这些资源并不会扩展或以其他方式更改 TI 针对 TI 产品发布的适用的担保或担保免责声明。

TI 反对并拒绝您可能提出的任何其他或不同的条款。

邮寄地址：Texas Instruments, Post Office Box 655303, Dallas, Texas 75265

Copyright © 2023，德州仪器 (TI) 公司

## X-ON Electronics

Largest Supplier of Electrical and Electronic Components

*Click to view similar products for [Switching Voltage Regulators](#) category:*

*Click to view products by [Texas Instruments](#) manufacturer:*

Other Similar products are found below :

[FAN53610AUC33X](#) [FAN53611AUC123X](#) [EN6310QA](#) [160215](#) [R3](#) [KE177614](#) [FAN53611AUC12X](#) [MAX809TTR](#) [NCV891234MW50R2G](#)  
[AST1S31PUR](#) [NCP81203PMNTXG](#) [NCP81208MNTXG](#) [PCA9412AUKZ](#) [NCP81109GMNTXG](#) [NCP3235MNTXG](#) [NCP81109JMNTXG](#)  
[NCP81241MNTXG](#) [NTE7223](#) [NTE7222](#) [NTE7224](#) [L6986FTR](#) [MPQ4481GU-AEC1-P](#) [MP8756GD-P](#) [MPQ2171GJ-P](#) [MPQ2171GJ-AEC1-P](#)  
[N JW4153U2-A-TE2](#) [MP2171GJ-P](#) [MP28160GC-Z](#) [MPM3509GQVE-AEC1-P](#) [XDPE132G5CG000XUMA1](#) [LM60440AQRPKRQ1](#)  
[MP5461GC-P](#) [NCV896530MWATXG](#) [MPQ4409GQBE-AEC1-P](#) [S-19903DA-A8T1U7](#) [S-19903CA-A6T8U7](#) [S-19903CA-S8T1U7](#) [S-](#)  
[19902BA-A6T8U7](#) [S-19902CA-A6T8U7](#) [S-19902AA-A6T8U7](#) [S-19903AA-A6T8U7](#) [S-19902AA-S8T1U7](#) [S-19902BA-A8T1U7](#) [AU8310](#)  
[LMR23615QDRRRQ1](#) [LMR33630APAQRN XRQ1](#) [LMR36503R5RPER](#) [LMR36503RFRPER](#) [LMR36503RS3QRPERQ1](#)  
[LMR36506R5RPER](#)