

TPS6280x 采用 6 引脚 0.35mm 间距 WCSP 封装的 1.75V 至 5.5V、0.6A/1A、2.3 μ A I_Q 降压转换器

1 特性

- 1.75V 至 5.5V 输入电压范围
- 2.3 μ A 工作静态电流
- 开关频率高达 4MHz
- 0.6A 或 1A 输出电流
- 1% 的输出电压精度
- 可选择省电和强制 PWM 模式
- R2D 转换器，可实现灵活的输出电压测试
- 16 种可选输出电压和 1 种固定输出电压
 - TPS62800 (4MHz) : 0.4V 至 0.775V
 - TPS62801 (4MHz) : 0.8V 至 1.55V
 - TPS62802 (4MHz) : 1.8V 至 3.3V
 - TPS62806 (1.5MHz) : 0.4V 至 0.775V
 - TPS62807 (1.5MHz) : 0.8V 至 1.55V
 - TPS62808 (1.5MHz) : 1.8V 至 3.3V
- 智能使能引脚
- 经过优化的引脚排列，可支持 0201 元件
- DCS-Control 拓扑
- 输出放电
- 以 100% 的占空比运行
- 微型 6 引脚 0.35mm 间距 WCSP 封装
- 支持小于 0.6mm 的解决方案高度
- 支持小于 5mm² 的解决方案尺寸
- 借助以下工具创建定制设计方案：
 - TPS62800 [WEBENCH® Power Designer](#)
 - TPS62801 [WEBENCH® Power Designer](#)
 - TPS62802 [WEBENCH® Power Designer](#)
 - TPS62806 [WEBENCH® Power Designer](#)
 - TPS62807 [WEBENCH® Power Designer](#)
 - TPS62808 [WEBENCH® Power Designer](#)

2 应用

- 可穿戴电子产品、物联网应用
- 2 节 AA 电池供电型应用
- 智能手机

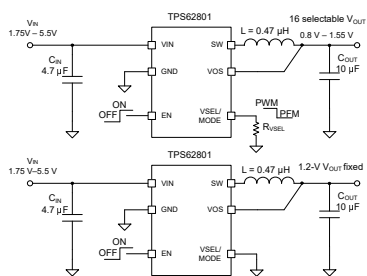

典型应用

3 说明

TPS6280x 器件系列是一款降压转换器，具有 2.3 μ A 的典型静态电流以及出色的效率和超小的解决方案尺寸。该器件利用 TI 的 DCS-Control™ 拓扑，能够与微型电感器和电容器配合使用，并且具有高达 4MHz 的开关频率。在轻负载条件下，该器件会无缝进入节能模式，从而减少开关周期数并保持高效率。

将 VSEL/MODE 引脚连接到 GND 可以选择固定输出电压。只需将一个外部电阻器连接到 VSEL/MODE 引脚，就可以选择 16 种内部设置的输出电压。使用集成 R2D (电阻器到数字) 转换器，可读取外部电阻器并设置输出电压。仅需通过更换单个电阻，相同的器件型号即可用于不同的应用和电压轨。此外，与传统的外部电阻分压器网络相比，内部设置的输出电压可提供更高的精度。该器件启动之后，直流/直流转换器将进入强制 PWM 模式 (通过在 VSEL/MODE 引脚上施加高电平)。在该工作模式下，此器件通常以 4MHz 或 1.5MHz 的开关频率运行，从而能够实现最低的输出电压纹波和最高的效率。TPS6280x 器件系列采用具有 0.35mm 间距的微型 6 引脚 WCSP 封装。

器件信息

器件型号	封装 ⁽¹⁾	封装尺寸 (标称值)
TPS62800	DSBGA (6)	1.05 mm × 0.70 mm × 0.4 mm
TPS62801		
TPS62802		
TPS62806		
TPS62807		
TPS62808		

(1) 如需了解所有可用封装，请参阅数据表末尾的可订购产品附录。

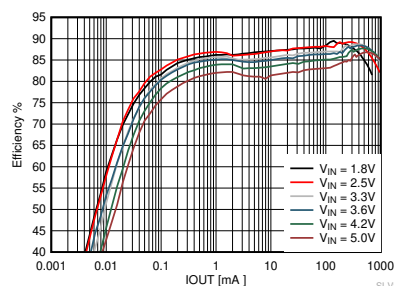

V_{OUT} 为 1.2V 时，效率与 I_{OUT} 间的关系



Table of Contents

1 特性	1	9 Application and Implementation	15
2 应用	1	9.1 Application Information.....	15
3 说明	1	9.2 Typical Application.....	15
4 Revision History	2	9.3 System Examples.....	28
5 器件比较表	3	10 Power Supply Recommendations	30
6 Pin Configuration and Functions	3	11 Layout	30
7 Specifications	5	11.1 Layout Guidelines.....	30
7.1 Absolute Maximum Ratings.....	5	11.2 Layout Example.....	30
7.2 ESD Ratings.....	5	12 Device and Documentation Support	31
7.3 Recommended Operating Conditions.....	5	12.1 Device Support.....	31
7.4 Thermal Information.....	6	12.2 接收文档更新通知.....	31
7.5 Electrical Characteristics.....	6	12.3 支持资源.....	31
7.6 Typical Characteristics.....	8	12.4 Trademarks.....	31
8 Detailed Description	10	12.5 Electrostatic Discharge Caution.....	31
8.1 Overview.....	10	12.6 术语表.....	32
8.2 Functional Block Diagram.....	10	13 Mechanical, Packaging, and Orderable	
8.3 Feature Description.....	10	Information	32
8.4 器件功能模式.....	13		

4 Revision History

注：以前版本的页码可能与当前版本的页码不同

Changes from Revision E (July 2018) to Revision F (June 2022)	Page
• 更新了整个文档中的表格、图和交叉参考的编号格式.....	1
• 将最小输入电压更新为 1.75V.....	1
• Updated max rising UVLO spec.....	6

Changes from Revision D (July 2018) to Revision E (January 2019)	Page
• 在整个数据表中添加了 TPS62807 和 TPS62808 器件.....	1

5 器件比较表

器件	功能 VSEL/MODE	固定输出电压	借助 R_{VSEL} 实现的可选的 输出电压	f_{sw} [MHz]	I_{OUT} [A]	软 启动, t_{ss}	输出 放电
TPS62800	VSEL + MODE	0.7V (VSEL/MODE = GND)	0.4V 至 0.775V (阶跃为 25mV)	4	1	125 μ s	是
TPS62801	VSEL + MODE	1.20V (VSEL/MODE = GND)	0.8V 至 1.55V (阶跃为 50mV)	4	1	125 μ s	是
TPS62802	VSEL + MODE	1.8V (VSEL/MODE = GND)	1.8V 至 3.3V (阶跃为 100mV)	4	1	400 μ s	是
TPS62806	VSEL + MODE	0.7V (VSEL/MODE = GND)	0.4V 至 0.775V (阶跃为 25mV)	1.5	0.6	125 μ s	是
TPS62807	VSEL + MODE	1.20V (VSEL/MODE = GND)	0.8V 至 1.55V (阶跃为 50mV)	1.5	0.6	125 μ s	是
TPS62808	VSEL + MODE	1.8V (VSEL/MODE = GND)	1.8V 至 3.3V (阶跃为 100mV)	1.5	0.6	125 μ s	是

6 Pin Configuration and Functions



图 6-1. 6-Pin DSBGA YKA Package (Top View)

表 6-1. Pin Functions

Pin		I/O	Description
Name	NO.		
GND	A1	PWR	GND supply pin. Connect this pin close to the GND terminal of the input and output capacitor.
VIN	B1	PWR	V_{IN} power supply pin. Connect the input capacitor close to this pin for best noise and voltage spike suppression. A ceramic capacitor is required.
VSEL/MODE	C1	IN	Connecting a resistor to GND selects a pre-defined output voltage. Once the device has started up, the R2D converter is disabled and the pin operates as an input. Applying a high level selects forced PWM mode operation and a low level power save mode operation.
VOS	A2	IN	Output voltage sense pin for the internal feedback divider network and regulation loop. This pin also discharges V_{OUT} by an internal MOSFET when the converter is disabled. Connect this pin directly to the output capacitor with a short trace.
SW	B2	OUT	The switch pin is connected to the internal MOSFET switches. Connect the inductor to this terminal.

表 6-1. Pin Functions (continued)

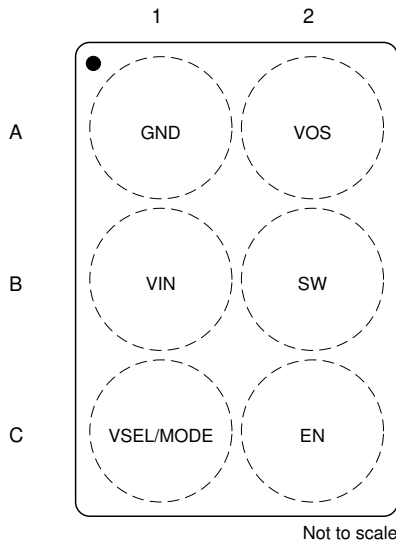
Pin		I/O	Description
Name	NO.		
EN	C2	IN	A high level enables the devices, and a low level turns the device off. The pin features an internal pulldown resistor, which is disabled once the device has started up.

表 6-2. Output Voltage Setting (VSEL/MODE Pin)

VSEL	Output Voltage Setting V_{OUT} [V]			R_{VSEL} Resistance [k Ω], E96 Resistor Series, 1% Accuracy, Temperature Coefficient Better or Equal than ± 200 ppm/ $^{\circ}$ C
	TPS62800 TPS62806	TPS62801 TPS62807	TPS62802 TPS62808	
0	0.700	1.2	1.8	Connected to GND (no resistor needed)
1	0.400	0.8	1.8	10.0
2	0.425	0.85	1.9	12.1
3	0.450	0.9	2.0	15.4
4	0.475	0.95	2.1	18.7
5	0.500	1.0	2.2	23.7
6	0.525	1.05	2.3	28.7
7	0.550	1.1	2.4	36.5
8	0.575	1.15	2.5	44.2
9	0.600	1.2	2.6	56.2
10	0.625	1.25	2.7	68.1
11	0.650	1.3	2.8	86.6
12	0.675	1.35	2.9	105.0
13	0.700	1.4	3.0	133.0
14	0.725	1.45	3.1	162.0
15	0.750	1.5	3.2	205.0
16	0.775	1.55	3.3	249.0 or larger

7 Specifications

7.1 Absolute Maximum Ratings

		MIN ⁽¹⁾	MAX ⁽¹⁾	UNIT
Pin voltage ⁽²⁾	V _{IN}	- 0.3	6	V
	SW	- 0.3	V _{IN} + 0.3 V	V
	SW (AC), less than 10 ns while switching	- 2.5	9	V
	EN, VSEL/MODE	- 0.3	6	V
	VOS	- 0.3	5	V
Operating junction temperature, T _J		- 40	150	°C
Storage temperature, T _{stg}		- 65	150	°C

- (1) Stresses beyond those listed under *absolute maximum ratings* may cause permanent damage to the device. These are stress ratings only and functional operation of the device at these or any other conditions beyond those indicated under *recommended operating conditions* is not implied. Exposure to absolute - maximum - rated conditions for extended periods may affect device reliability.
- (2) All voltage values are with respect to network ground terminal GND.

7.2 ESD Ratings

			VALUE	UNIT
V _(ESD)	Electrostatic discharge	Human body model (HBM), per ANSI/ESDA/JEDEC JS-001, all pins ⁽¹⁾	±2000	V
		Charged device model (CDM), per JEDEC specification JESD22-C101, all pins ⁽²⁾	±500	

- (1) JEDEC document JEP155 states that 500-V HBM allows safe manufacturing with a standard ESD control process. The human body model is a 100-pF capacitor discharged through a 1.5-kΩ resistor into each pin.
- (2) JEDEC document JEP157 states that 250-V CDM allows safe manufacturing with a standard ESD control process.

7.3 Recommended Operating Conditions

		MIN	NOM	MAX	UNIT
V _{IN}	Supply voltage, V _{IN}	1.75		5.5	V
I _{OUT}	Output current, V _{IN} ≥ 2.3 V, TPS62800, TPS62801, TPS62802			1	A
I _{OUT}	Output current, V _{IN} < 2.3 V, TPS62800, TPS62801, TPS62802			0.7	A
I _{OUT}	Output current, TPS62806, TPS62807, TPS62808			0.6	A
L	Effective inductance, TPS62800, TPS62801, TPS62802	0.33	0.47	0.82	μH
C _{OUT}	Effective output capacitance, TPS62800, TPS62801, TPS62802	2		26	μF
L	Effective inductance, TPS62806, TPS62807, TPS62808	0.7	1.0	1.2	μH
C _{OUT}	Effective output capacitance, TPS62806, TPS62807, TPS62808	3		26	μF
C _{IN}	Effective input capacitance	0.5	4.7		μF
C _{VSEL/MODE}	External parasitic capacitance at the VSEL/MODE pin			30	pF
R _{VSEL}	Resistance range for external resistor at VSEL/MODE pin (E96 1% resistor values)	10		249	kΩ
	External resistor tolerance E96 series at VSEL/MODE pin			1%	
	E96 resistor series temperature coefficient (TCR)	- 200		+200	ppm/°C
T _J	Operating junction temperature range	- 40		125	°C

7.4 Thermal Information

THERMAL METRIC ⁽¹⁾		YKA (DSBGA)	UNIT
		6 PINS	
$R_{\theta JA}$	Junction-to-ambient thermal resistance	147.7	°C/W
$R_{\theta JC(top)}$	Junction-to-case (top) thermal resistance	1.7	°C/W
$R_{\theta JB}$	Junction-to-board thermal resistance	47.5	°C/W
ψ_{JT}	Junction-to-top characterization parameter	0.5	°C/W
ψ_{JB}	Junction-to-board characterization parameter	47.6	°C/W
$R_{\theta JC(bot)}$	Junction-to-case (bottom) thermal resistance	—	°C/W

(1) For more information about traditional and new thermal metrics, see the [Semiconductor and IC Package Thermal Metrics](#) application report.

7.5 Electrical Characteristics

$V_{IN} = 3.6\text{ V}$, $T_J = -40^\circ\text{C}$ to 125°C typical values are at $T_J = 25^\circ\text{C}$ (unless otherwise noted)

PARAMETER		TEST CONDITIONS	MIN	TYP	MAX	UNIT
SUPPLY						
I_Q	Operating quiescent current (power save mode)	EN = V_{IN} , $I_{OUT} = 0\ \mu\text{A}$, $V_{OUT} = 1.2\text{ V}$, device not switching, $T_J = -40^\circ\text{C}$ to $+85^\circ\text{C}$		2.3	4	μA
		EN = V_{IN} , $I_{OUT} = 0\ \mu\text{A}$, $V_{OUT} = 1.2\text{ V}$, device switching		2.5		μA
	Operating quiescent current (PWM mode)	EN = V_{IN} , VSEL/MODE = V_{IN} (after power up), device switching, $I_{OUT} = 0\ \text{mA}$, $V_{OUT} = 1.2\text{ V}$		8		mA
I_{SD}	Shutdown current	EN = GND, shutdown current into V_{IN} , VSEL/MODE = GND, $T_J = -40^\circ\text{C}$ to $+85^\circ\text{C}$		120	250	nA
V_{TH_UVLO+}	Undervoltage lockout threshold	Rising V_{IN}		1.65	1.75	V
V_{TH_UVLO-}		Falling V_{IN}		1.56	1.7	V
INPUT EN						
$V_{IH\ TH}$	High level input voltage		0.8			V
$V_{IL\ TH}$	Low level input voltage				0.4	V
I_{IN}	Input bias current	$T_J = -40^\circ\text{C}$ to $+85^\circ\text{C}$, EN = high		10	25	nA
R_{PD}	Internal pulldown resistance	EN = low		500		k Ω
INPUT VSEL/MODE						
$V_{IH\ TH}$	High level input voltage (digital input)		0.8			V
$V_{IL\ TH}$	Low level input voltage (digital input)				0.4	V
I_{IN}	Input bias current	EN = high		10	25	nA
POWER SWITCHES						
I_{LKG_SW}	Leakage current into the SW pin	$V_{SW} = 1.2\text{ V}$, $T_J = -40^\circ\text{C}$ to $+85^\circ\text{C}$		10	25	nA
$R_{DS(ON)}$	High side MOSFET on-resistance	$I_{OUT} = 500\ \text{mA}$		120	170	m Ω
	Low side MOSFET on-resistance	$I_{OUT} = 500\ \text{mA}$		80	115	m Ω
I_{LIMF}	High-side MOSFET switch current limit	TPS62806, TPS62807, TPS62808	0.95	1.1	1.2	A
I_{LIMF}	Low-side MOSFET switch current limit	TPS62806, TPS62807, TPS62808	0.85	1	1.1	A
I_{LIMF}	High-side MOSFET switch current limit	TPS62800, TPS62801	1.3	1.45	1.55	A
		TPS62802	1.4	1.55	1.65	A
I_{LIMF}	Low-side MOSFET switch current limit	TPS62800, TPS62801	1.2	1.35	1.45	A
		TPS62802	1.3	1.45	1.55	A
OUTPUT VOLTAGE DISCHARGE						

$V_{IN} = 3.6\text{ V}$, $T_J = -40^\circ\text{C}$ to 125°C typical values are at $T_J = 25^\circ\text{C}$ (unless otherwise noted)

PARAMETER		TEST CONDITIONS	MIN	TYP	MAX	UNIT
R_{DSCH_VOS}	MOSFET on-resistance	EN = GND, $I_{VOS} = -10\text{ mA}$ into the VOS pin $T_J = -40^\circ\text{C}$ to $+85^\circ\text{C}$		7	11	Ω
I_{IN_VOS}	Bias current into the VOS pin	EN = V_{IN} , $V_{OUT} = 1.2\text{ V}$ (internal 12-M Ω resistor divider), $T_J = -40^\circ\text{C}$ to $+85^\circ\text{C}$		100	400	nA
THERMAL PROTECTION						
T_{SD}	Thermal shutdown temperature	Rising junction temperature, PWM mode		160		$^\circ\text{C}$
	Thermal shutdown hysteresis			20		$^\circ\text{C}$
OUTPUT						
V_{OUT}	Output voltage range	TPS62800, TPS62806, 25-mV steps	0.4		0.775	V
V_{OUT}	Output voltage range	TPS62801, TPS62807, 50-mV steps	0.8		1.55	V
V_{OUT}	Output voltage range	TPS62802, TPS62808, 100-mV steps	1.8		3.3	V
V_{OUT}	Output voltage accuracy	Power save mode		0%		
V_{OUT}	Output voltage accuracy	PWM mode, $I_{OUT} = 0\text{ mA}$, $T_J = 25^\circ\text{C}$ to $+85^\circ\text{C}$	- 1%	0%	1%	
V_{OUT}	Output voltage accuracy	PWM mode, $I_{OUT} = 0\text{ mA}$, $T_J = -40^\circ\text{C}$ to $+125^\circ\text{C}$	- 2%	0%	1.7%	
f_{SW}	Switching frequency	$V_{IN} = 3.6\text{ V}$, $V_{OUT} = 1.2\text{ V}$, PWM operation		4		MHz
f_{SW}	Switching frequency	TPS62806 $V_{IN} = 3.6\text{ V}$, $V_{OUT} = 0.7\text{ V}$, PWM operation		1.5		MHz
f_{SW}	Switching frequency	TPS62807 $V_{IN} = 3.6\text{ V}$, $V_{OUT} = 1.2\text{ V}$, PWM operation		1.5		MHz
f_{SW}	Switching frequency	TPS62808 $V_{IN} = 3.6\text{ V}$, $V_{OUT} = 1.8\text{ V}$, PWM operation		1.5		MHz
$t_{Startup_delay}$	Regulator start-up delay time	From transition EN = low to high until device starts switching, VSEL = 16		500	1100	μs
t_{SS}	Soft-start time	TPS62801, from $V_{OUT} = 0\text{ V}$ to 0.95% of V_{OUT} nominal		125	170	μs
t_{SS}	Soft-start time	TPS62800, TPS62806, TPS62807, TPS62808 from $V_{OUT} = 0\text{ V}$ to 0.95% of V_{OUT} nominal		125	210	μs
t_{SS}	Soft-start time	TPS62802, from $V_{OUT} = 0\text{ V}$ to 0.95% of V_{OUT} nominal		400	500	μs

7.6 Typical Characteristics



图 7-1. Shutdown Current, I_{SD}



图 7-2. Quiescent Current, I_Q

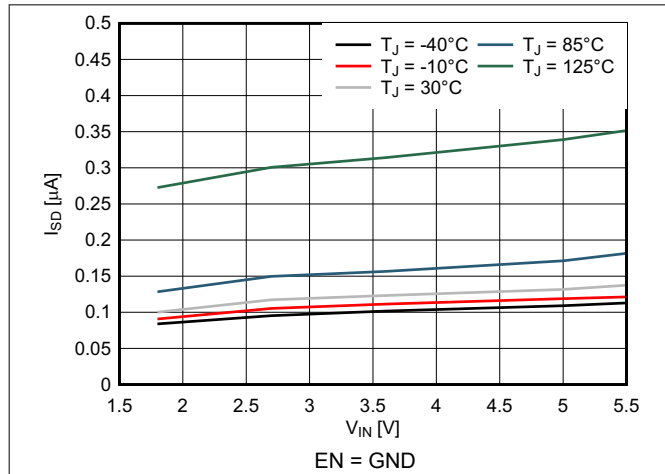

图 7-3. Operating Quiescent Current, I_Q

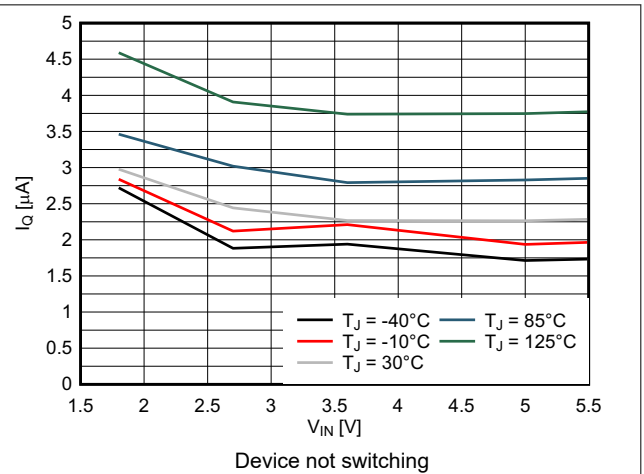

图 7-4. Operating Quiescent Current, I_Q

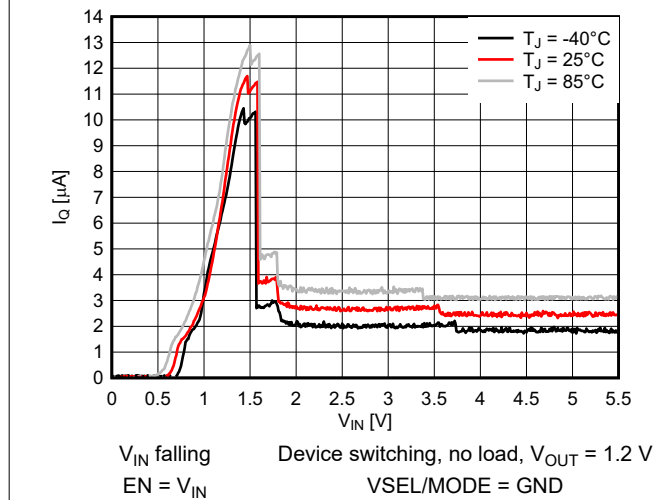

图 7-5. High-Side Switch Drain Source Resistance, $R_{DS(ON)}$

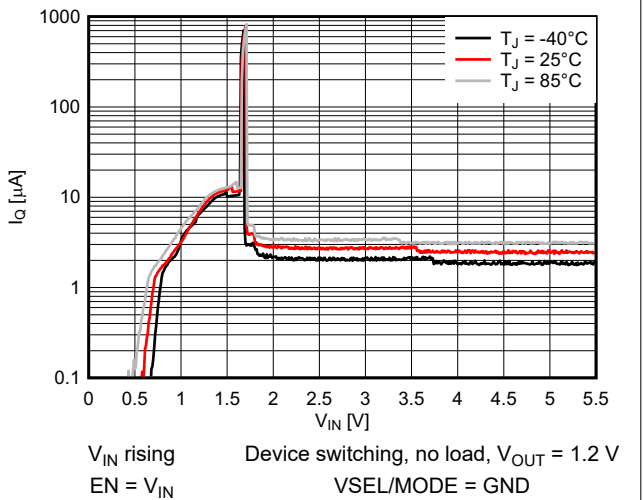

图 7-6. Low-Side Switch Drain Source Resistance, $R_{DS(ON)}$

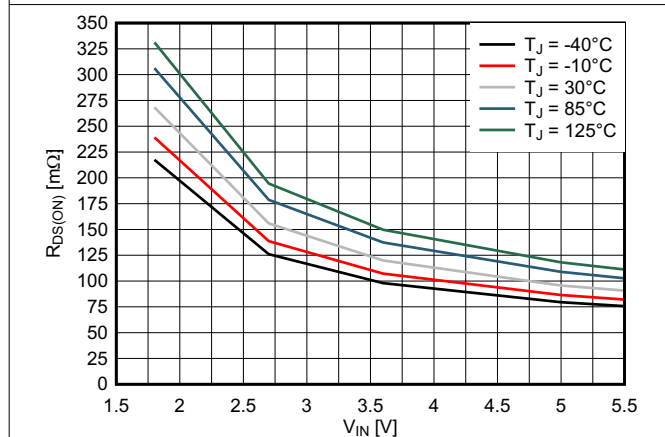

图 7-7. VOS Discharge Switch Drain Source Resistance, R_{DSCH_VOS}

8 Detailed Description

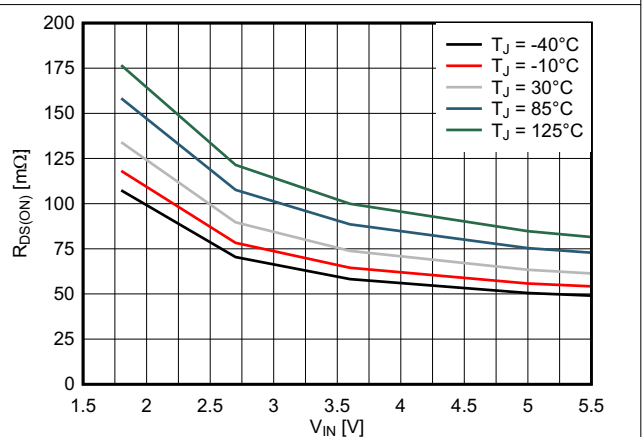
8.1 Overview

The TPS6280x is a high frequency synchronous step-down converter with ultra-low quiescent current consumption. Using TI's DCS-Control topology, the device extends the high efficiency operation area down to microamperes of load current during power save mode operation. TI's DCS-Control (Direct Control with Seamless Transition into power save mode) is an advanced regulation topology, which combines the advantages of hysteretic and voltage mode control. Characteristics of DCS-Control are excellent AC load regulation and transient response, low output ripple voltage, and a seamless transition between PFM and PWM mode operation. DCS-Control includes an AC loop, which senses the output voltage (VOS pin) and directly feeds the information to a fast comparator stage. This comparator sets the switching frequency, which is constant for steady state operating conditions, and provides immediate response to dynamic load changes. In order to achieve accurate DC load regulation, a voltage feedback loop is used. The internally compensated regulation network achieves fast and stable operation with small external components and low-ESR capacitors.

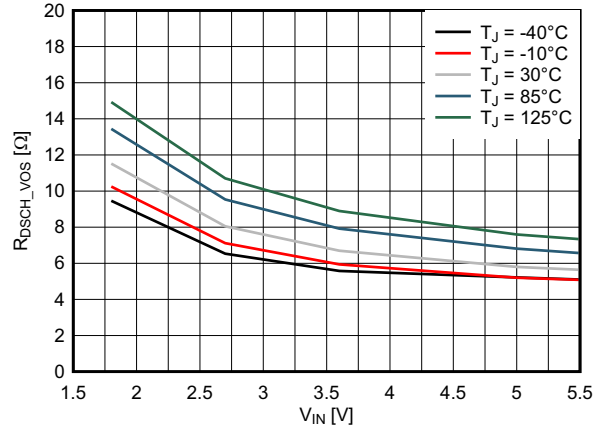
8.2 Functional Block Diagram



图 8-1. Functional Block Diagram

8.3 Feature Description

8.3.1 Smart Enable and Shutdown (EN)

An internal 500-kΩ resistor pulls the EN pin to GND and avoids the pin to be floating, which prevents an uncontrolled start-up of the device in case the EN pin cannot be driven to low level safely. With EN low, the device is in shutdown mode. The device is turned on with EN set to a high level. The pulldown control circuit disconnects the pulldown resistor on the EN pin once the internal control logic and the reference have been powered up. With EN set to a low level, the device enters shutdown mode and the pulldown resistor is activated again.

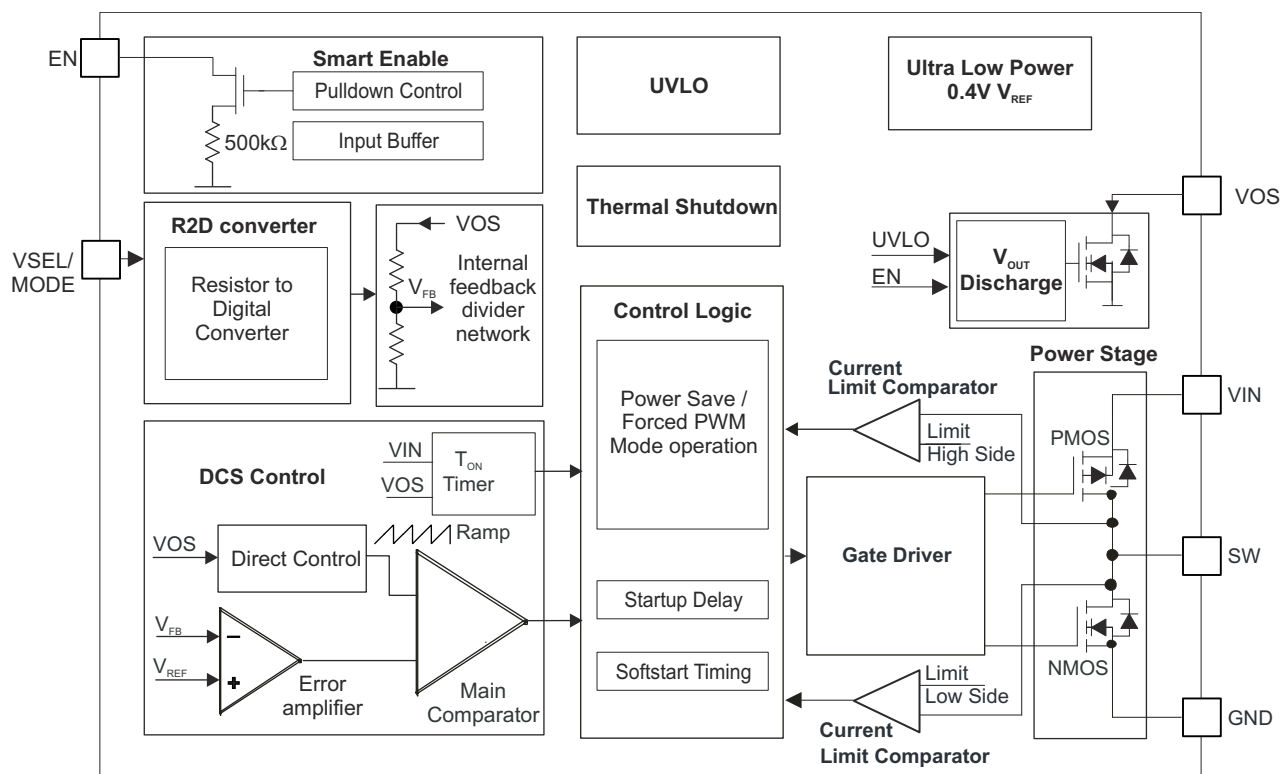
8.3.2 Soft Start

Once the device has been enabled with EN high, it initializes and powers up its internal circuits, which occurs during the regulator start-up delay time, $t_{\text{Startup_delay}}$. Once $t_{\text{Startup_delay}}$ expires, the internal soft-start circuitry ramps up the output voltage within the soft-start time, t_{SS} . See [图 8-2](#).

The start-up delay time, $t_{\text{Startup_delay}}$, varies depending on the selected VSEL value. $t_{\text{Startup_delay}}$ is shortest with VSEL = 0 and longest with VSEL = 16. See [图 9-42](#) to [图 9-46](#).



图 8-2. Device Start-Up

8.3.3 VSEL/MODE Pin

This pin has two functions: output voltage selection during start-up of the converter and operating mode selection. See [节 5](#).

8.3.3.1 Output Voltage Selection (R2D Converter)

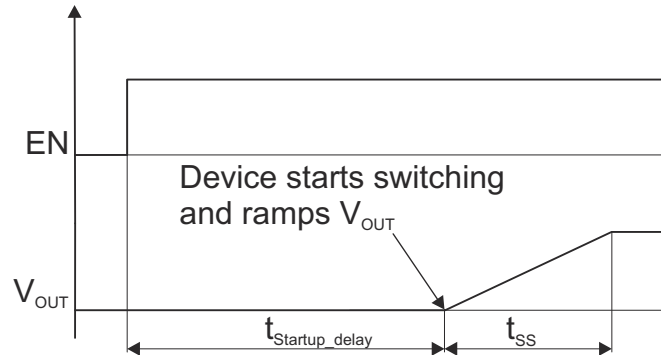
The output voltage is set with a single external resistor connected between the VSEL/MODE pin and GND. Once the device has been enabled and the control logic as well as the internal reference have been powered up, a R2D (resistor-to-digital) conversion is started to detect the external resistor R_{VSEL} within the regulator start-up delay time, $t_{\text{Startup_delay}}$. An internal current source applies current through the external resistor and an internal ADC reads back the resulting voltage level. Depending on the level, an internal feedback divider network is selected to set the correct output voltage. Once this R2D conversion is finished, the current source is turned off to avoid current flow through the external resistor.

After power up, the pin is configured as an input for mode selection. Therefore, the output voltage is set only once. If the mode selection function is used in combination with the VSEL function, ensure that there is no additional current path or capacitance greater than 30 pF total to GND during R2D conversion. Otherwise, the additional current to GND is interpreted as a lower resistor value and a false output voltage is set. [表 6-2](#) lists the correct resistor values for R_{VSEL} to set the appropriate output voltages. The R2D converter is designed to operate with resistor values out of the E96 table and requires 1% resistor value accuracy. The external resistor, R_{VSEL} , is not a part of the regulator feedback loop and has therefore no impact on the output voltage accuracy. Ensure that there is no other leakage path than the R_{VSEL} resistor at the VSEL/MODE pin during an undervoltage lockout event. Otherwise, a false output voltage will be set.

Connecting VSEL/MODE to GND selects a pre-defined output voltage.

- TPS62800 = 0.7 V
- TPS62801 = 1.2 V
- TPS62802 = 1.8 V
- TPS62806 = 0.7 V
- TPS62807 = 1.2 V
- TPS62808 = 1.8 V

In this case, no external resistor is needed, which enables a smaller solution size.

8.3.3.2 Mode Selection — Power Save Mode and Forced PWM Operation

A low level at this pin selects power save mode operation, and a high level selects forced PWM operation. The mode can be changed during operation after the device has been powered up. The mode selection function is only available after the R2D converter has read out the external resistor.

8.3.4 Undervoltage Lockout (UVLO)

To avoid misoperation of the device at low input voltages, an undervoltage lockout (UVLO) comparator monitors the supply voltage. The UVLO comparator shuts down the device at an input voltage of 1.7 V (maximum) with falling V_{IN} . The device starts at an input voltage of 1.75 V (maximum) rising V_{IN} . Once the device re-enters operation out of an undervoltage lockout condition, it behaves like being enabled. The internal control logic is powered up and the external resistor at the VSEL/MODE pin is read out.

8.3.5 Switch Current Limit and Short Circuit Protection

The TPS6280x integrates a current limit on the high-side and low-side MOSFETs to protect the device against overload or short circuit conditions. The current in the switches is monitored cycle by cycle. If the high-side MOSFET current limit, I_{LIMF} , trips, the high-side MOSFET is turned off and the low-side MOSFET is turned on to ramp down the inductor current. Once the inductor current through the low-side switch decreases below the low-side MOSFET current limit, I_{LIMF} , the low-side MOSFET is turned off and the high-side MOSFET turns on again.

8.3.6 Thermal Shutdown

The junction temperature (T_J) of the device is monitored by an internal temperature sensor. If T_J exceeds the thermal shutdown temperature, T_{SD} , of 160°C (typical), the device enters thermal shutdown. Both the high-side and low-side power FETs are turned off. When T_J decreases below the hysteresis amount of typically 20°C, the converter resumes operation, beginning with a soft start to the originally set V_{OUT} (there is no R2D conversion of R_{VSEL}). The thermal shutdown is not active in power save mode.

8.3.7 Output Voltage Discharge

The purpose of the output discharge function is to ensure a defined down-ramp of the output voltage when the device is disabled and to keep the output voltage close to 0 V. The output discharge feature is only active once the device has been enabled at least once since the supply voltage was applied. The output discharge function is not active if the device is disabled and the supply voltage is applied the first time.

The internal discharge resistor is connected to the VOS pin. The discharge function is enabled as soon as the device is disabled. The minimum supply voltage required to keep the discharge function active is $V_{IN} > V_{TH_UVLO}$.

8.4 器件功能模式

8.4.1 Power Save Mode Operation

The DCS-Control topology supports power save mode operation. At light loads, the device operates in PFM (pulse frequency modulation) mode that generates a single switching pulse to ramp up the inductor current and recharge the output capacitor, followed by a sleep period where most of the internal circuits are shut down to achieve lowest operating quiescent current. During this time, the load current is supported by the output capacitor. The duration of the sleep period depends on the load current and the inductor peak current. During the sleep periods, the current consumption is reduced to typically 2.3 μA . This low quiescent current consumption is achieved by an ultra-low power voltage reference, an integrated high impedance feedback divider network, and an optimized power save mode operation.

In PFM mode, the switching frequency varies linearly with the load current. At medium and high load conditions, the device automatically enters PWM (pulse width modulation) mode and operates in continuous conduction mode with a nominal switch frequency, f_{sw} , of typically 4 MHz or 1.5 MHz. The switching frequency in PWM mode is controlled and depends on V_{IN} and V_{OUT} . The boundary between PWM and PFM mode is when the inductor current becomes discontinuous.

If the load current decreases, the converter seamlessly enters PFM mode to maintain high efficiency down to very light loads. Since DCS-Control supports both operation modes within one single building block, the transition from PWM to PFM mode is seamless with minimum output voltage ripple.

8.4.2 Forced PWM Mode Operation

After the device has powered up and ramped up V_{OUT} , the VSEL/MODE pin acts as an input. With a high level on VSEL/MODE pin, the device enters forced PWM mode and operates with a constant switching frequency over the entire load range, even at very light loads. This action reduces or eliminates interference with RF and noise sensitive circuits, but lowers efficiency at light loads.

8.4.3 100% Mode Operation

The duty cycle of the buck converter operating in PWM mode is given as $D = V_{\text{OUT}} / V_{\text{IN}}$. The duty cycle increases as the input voltage comes close to the output voltage. In 100% duty cycle mode, the device keeps the high-side switch on continuously. The high-side switch stays turned on as long as the output voltage is below the internal set point, which allows the conversion of small input to output voltage differences.

8.4.4 Optimized Transient Performance from PWM-to-PFM Mode Operation

For most converters, the load transient response in PWM mode is improved compared to PFM mode, since the converter reacts faster on the load step and actively sinks energy on the load release. Compare [图 9-33](#) to [图 9-32](#). As an additional feature, the TPS6280x automatically enters PWM mode for 16 cycles after a heavy load release to bring the output voltage back to the regulation level faster. After 16 cycles of PWM mode, the device automatically returns to PFM mode (if VSEL/MODE is driven low). See [图 8-3](#). Without this optimization, the output voltage overshoot would be higher and would look like the V_{OUT} ' trace. This feature is only active once the load is high enough and the converter operates in PWM mode.



图 8-3. Optimized Transient Performance from PWM-to-PFM Mode

9 Application and Implementation

备注

以下应用部分中的信息不属于 TI 器件规格的范围，TI 不担保其准确性和完整性。TI 的客户应负责确定器件是否适用于其应用。客户应验证并测试其设计，以确保系统功能。

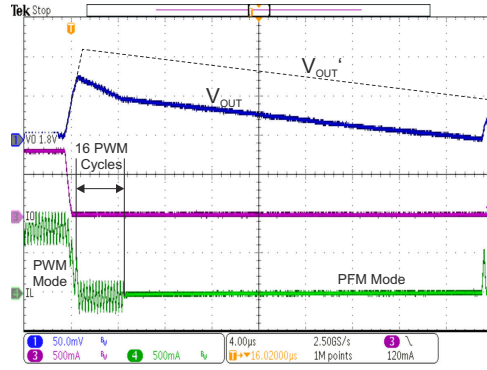
9.1 Application Information

The following section discusses the design of the external components to complete the power supply design for several input and output voltage options by using typical applications as a reference.

9.2 Typical Application



图 9-1. TPS62801 Adjustable V_{OUT} Application Circuit

Additional circuits are shown in 节 9.3.

9.2.1 Design Requirements

表 9-1 shows the list of components for the application circuit and the characteristic application curves

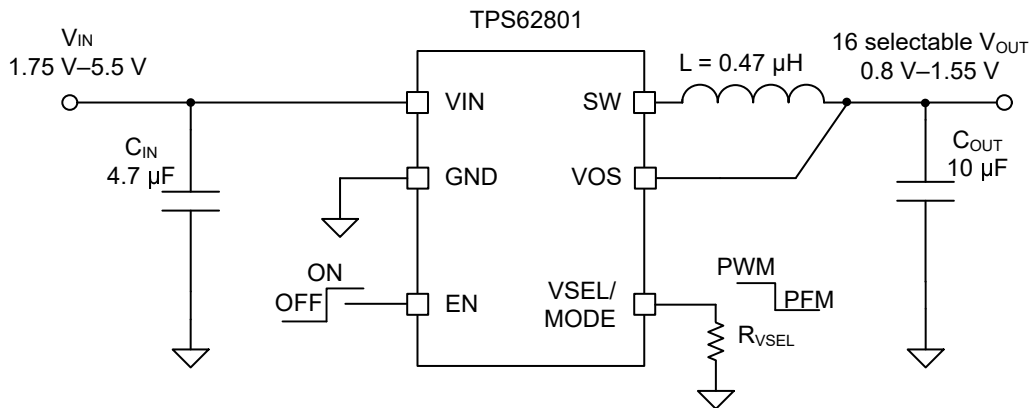
表 9-1. Components for Application Characteristic Curves

Reference	Description	Value	Size [L × W × T]	Manufacturer ⁽¹⁾
TPS62801 / 2	Step down converter		1.05 mm × 0.70 mm × 0.4 mm maximum	Texas Instruments
C _{IN}	Ceramic capacitor, GRM155R60J475ME47D	4.7 µF	0402 (1 mm × 0.5 mm × 0.6 mm maximum)	Murata
C _{OUT}	Ceramic capacitor, GRM155R60J106ME15D	10 µF	0402 (1 mm × 0.5 mm × 0.65 mm maximum)	Murata
L	Inductor DFE18SANR47MG0L	0.47 µH	0603 (1.6 mm × 0.8 mm × 1.0 mm maximum)	Murata

(1) See the [Third-party Products Disclaimer](#).

9.2.2 Detailed Design Procedure

9.2.2.1 Custom Design With WEBENCH® Tools

[Click here](#) to create a custom design using the TPS62800 device with the WEBENCH® Power Designer.

[Click here](#) to create a custom design using the TPS62801 device with the WEBENCH® Power Designer.

[Click here](#) to create a custom design using the TPS62802 device with the WEBENCH® Power Designer.

[Click here](#) to create a custom design using the TPS62806 device with the WEBENCH® Power Designer.

[Click here](#) to create a custom design using the TPS62807 device with the WEBENCH® Power Designer.

[Click here](#) to create a custom design using the TPS62808 device with the WEBENCH® Power Designer.

1. Start by entering the input voltage (V_{IN}), output voltage (V_{OUT}), and output current (I_{OUT}) requirements.
2. Optimize the design for key parameters such as efficiency, footprint, and cost using the optimizer dial.
3. Compare the generated design with other possible solutions from Texas Instruments.

The WEBENCH Power Designer provides a customized schematic along with a list of materials with real-time pricing and component availability.

In most cases, these actions are available:

- Run electrical simulations to see important waveforms and circuit performance
- Run thermal simulations to understand board thermal performance
- Export customized schematic and layout into popular CAD formats
- Print PDF reports for the design, and share the design with colleagues

Get more information about WEBENCH tools at www.ti.com/WEBENCH.

9.2.2.2 Inductor Selection

The inductor value affects the peak-to-peak ripple current, the PWM-to-PFM transition point, the output voltage ripple, and the efficiency. The selected inductor has to be rated for its DC resistance and saturation current. The inductor ripple current (ΔI_L) decreases with higher inductance and increases with higher V_{IN} or V_{OUT} and can be estimated according to [方程式 1](#).

[方程式 2](#) calculates the maximum inductor current under static load conditions. The saturation current of the inductor must be rated higher than the maximum inductor current, as calculated with [方程式 2](#), which is recommended because during a heavy load transient the inductor current rises above the calculated value. A more conservative way is to select the inductor saturation current according to the high-side MOSFET switch current limit, I_{LIMF} .

$$\Delta I_L = V_{out} \times \frac{1 - \frac{V_{out}}{V_{in}}}{L \times f} \quad (1)$$

$$I_{Lmax} = I_{outmax} + \frac{\Delta I_L}{2} \quad (2)$$

where

- f = switching frequency
- L = inductor value
- ΔI_L = peak-to-peak inductor ripple current
- I_{Lmax} = maximum inductor current

表 9-2 shows a list of possible inductors.

表 9-2. List of Possible Inductors

Inductance [μH]	Inductor Series	Size Imperial (Metric)	Dimensions L × W × T	Supplier ⁽¹⁾
0.47	DFE18SAN_G0	0603 (1608)	1.6 mm × 0.8 mm × 1.0 mm maximum	Murata
0.47	HTEB16080F	0603 (1608)	1.6 mm × 0.8 mm × 0.6 mm maximum	Cyntec
0.47	HTET1005FE	0402 (1005)	1.0 mm × 0.5 mm × 0.65 mm maximum	Cyntec
0.47	TFM160808ALC	0603 (1608)	1.6 mm × 0.8 mm × 0.8 mm maximum	TDK
1.0	DFE201610E	0806 (201610)	2.0 mm × 1.6 mm × 1.0 mm maximum	Murata

(1) See the [Third-party Products Disclaimer](#).

9.2.2.3 Output Capacitor Selection

The DCS-Control scheme of the TPS6280x allows the use of tiny ceramic capacitors. Ceramic capacitors with low-ESR values have the lowest output voltage ripple and are recommended. The output capacitor requires either an X7R or X5R dielectric. At light load currents, the converter operates in power save mode and the output voltage ripple is dependent on the output capacitor value. A larger output capacitors can be used reducing the output voltage ripple.

The inductor and output capacitor together provide a low-pass filter. To simplify this process, 表 9-3 outlines possible inductor and capacitor value combinations.

表 9-3. Recommended LC Output Filter Combinations

Device	Nominal Inductor Value [μH]	Nominal Output Capacitor Value [μF]			
		4.7 μF	10 μF	2 × 10 μF	22 μF
TPS62800, TPS62801	0.47 ⁽¹⁾	✓	✓ ⁽³⁾	✓	✓
TPS62802	0.47 ⁽¹⁾		✓ ⁽³⁾	✓	✓
TPS62806, TPS62807, TPS62808	1.0 ⁽²⁾	✓	✓ ⁽³⁾	✓	✓

(1) An effective inductance range of 0.33 μH to 0.82 μH is recommended. An effective capacitance range of 2 μF to 26 μF is recommended.

(2) An effective inductance range of 0.7 μH to 1.2 μH is recommended. An effective capacitance range of 3 μF to 26 μF is recommended.

(3) Typical application configuration. Other check marks indicate alternative filter combinations.

9.2.2.4 Input Capacitor Selection

Because the buck converter has a pulsating input current, a low-ESR ceramic input capacitor is required for best input voltage filtering to minimize input voltage spikes. For most applications, a 4.7- μF input capacitor is sufficient. When operating from a high impedance source, like a coin cell, a larger input buffer capacitor $\geq 10 \mu\text{F}$ is recommended to avoid voltage drops during start-up and load transients. The input capacitor can be increased without any limit for better input voltage filtering. The leakage current of the input capacitor adds to the overall current consumption.

表 9-4 shows a selection of input and output capacitors.

表 9-4. List of Possible Capacitors

Capacitance [μF]	Capacitor Part Number	Size Imperial (Metric)	Dimensions L × W × T	Supplier ⁽¹⁾
4.7	GRM155R60J475ME47D	0402 (1005)	1.0 mm × 0.5 mm × 0.6 mm maximum	Murata
4.7	GRM035R60J475ME15	0201 (0603)	0.6 mm × 0.3 mm × 0.55 mm maximum	Murata

表 9-4. List of Possible Capacitors (continued)

Capacitance [μ F]	Capacitor Part Number	Size Imperial (Metric)	Dimensions L \times W \times T	Supplier ⁽¹⁾
10	GRM155R60J106ME15D	0402 (1005)	1.0 mm \times 0.5 mm \times 0.65 mm maximum	Murata

(1) See the [Third-party Products Disclaimer](#).

9.2.3 Application Curves

The conditions for the below application curves are $V_{IN} = 3.6\text{ V}$, $V_{OUT} = 1.2\text{ V}$, and the components listed in 表 9-1, unless otherwise noted.



图 9-2. Efficiency Power Save Mode
 $V_{OUT} = 0.4\text{ V}$



图 9-3. Efficiency Power Save Mode
 $V_{OUT} = 0.7\text{ V}$

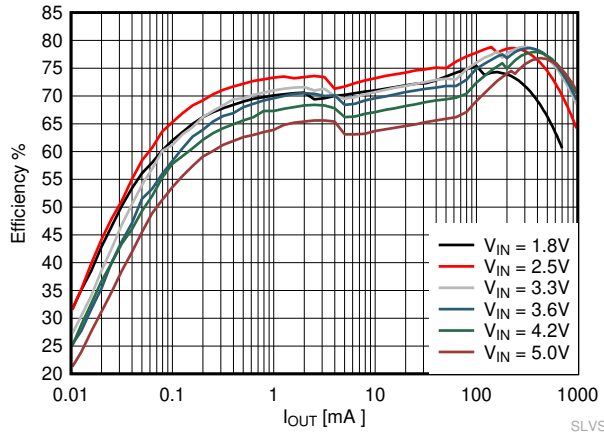

图 9-4. Efficiency Power Save Mode
 $V_{OUT} = 0.8\text{ V}$

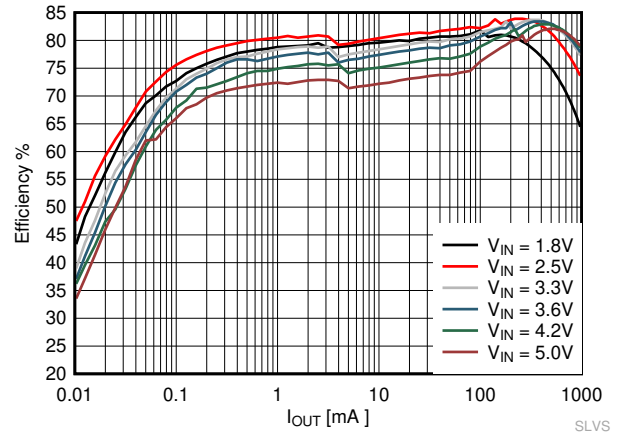

图 9-5. Efficiency Power Save Mode
 $V_{OUT} = 0.9\text{ V}$

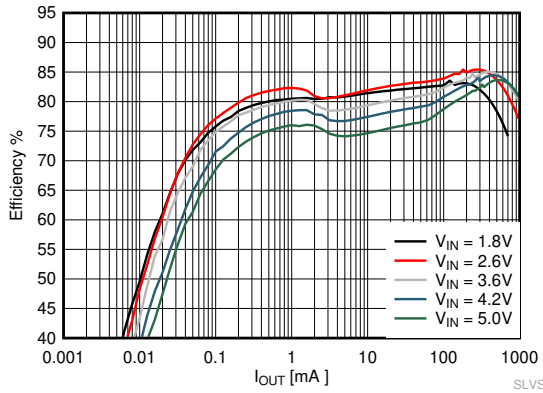

TPS62801 $R_{VSEL} = 56.2 \text{ k}\Omega$
 VSEL/MODE pin = high after start-up

图 9-6. Efficiency Forced PWM Mode
 $V_{OUT} = 1.2 \text{ V}$

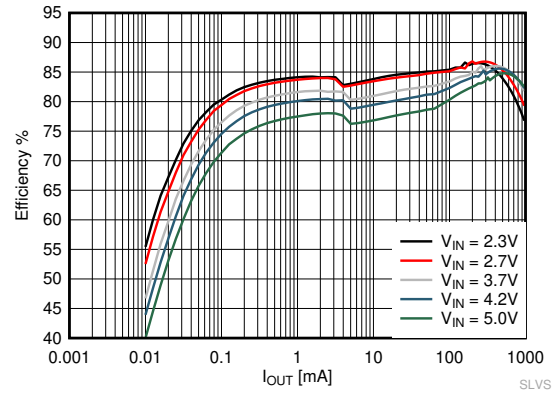
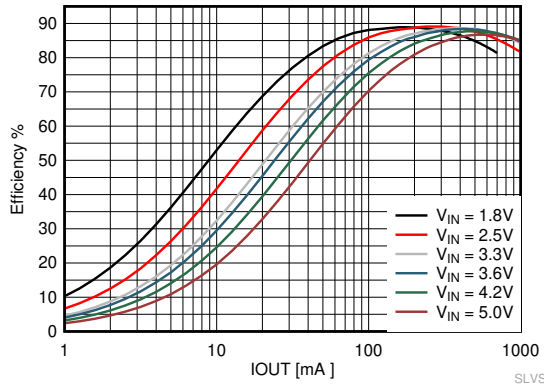
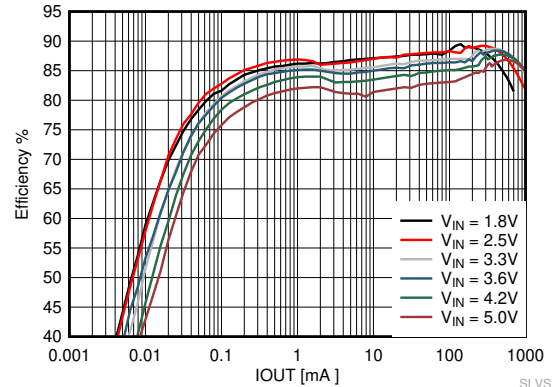

TPS62801 VSEL/MODE = GND

图 9-7. Efficiency Power Save Mode
 $V_{OUT} = 1.2 \text{ V}$

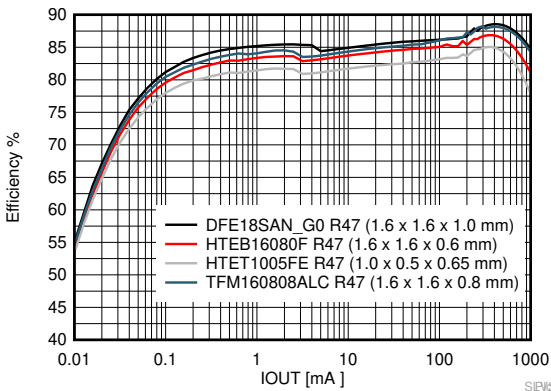

TPS62801 VSEL/MODE = GND, $V_{OUT} = 1.2 \text{ V}$

图 9-8. Inductor Comparison

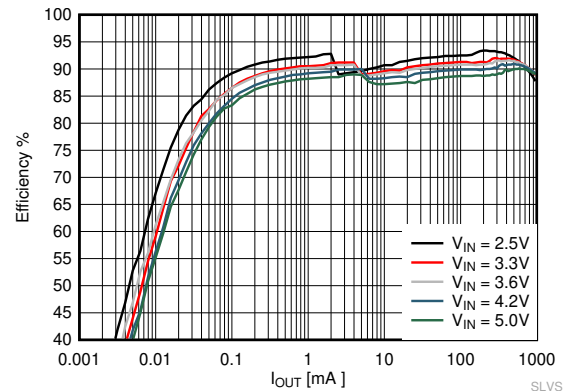

TPS62802 VSEL/MODE = GND

图 9-9. Efficiency Power Save Mode
 $V_{OUT} = 1.8 \text{ V}$

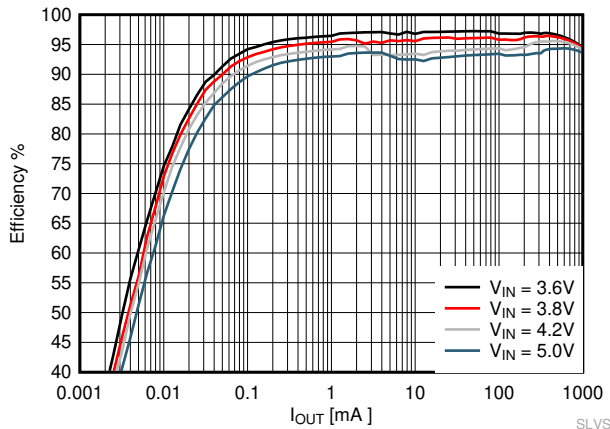

TPS62802 $3.3 \text{ V } V_{OUT}$, VSEL/MODE = 249 k

图 9-10. Efficiency Power Save Mode
 $V_{OUT} = 3.3 \text{ V}$

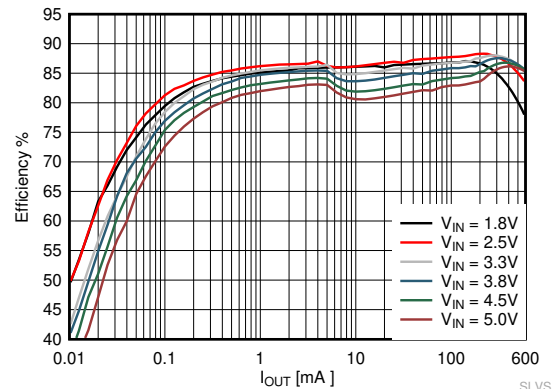

TPS62806 $V_{OUT} = 0.7 \text{ V}$, VSEL/MODE = GND
 $L = 1\text{-}\mu\text{H DFE201610E}$

图 9-11. Efficiency Power Save Mode
 $V_{OUT} = 0.7 \text{ V}$

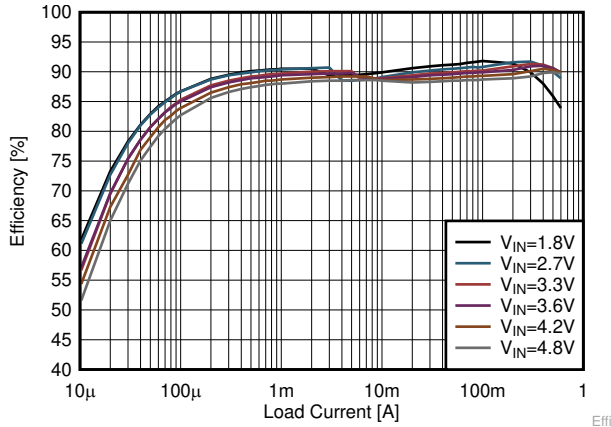

TPS62807 $V_{OUT} = 1.2\text{ V}$, VSEL/MODE = GND
L = 1- μH DFE201610E

图 9-12. Efficiency Power Save Mode
 $V_{OUT} = 1.2\text{ V}$

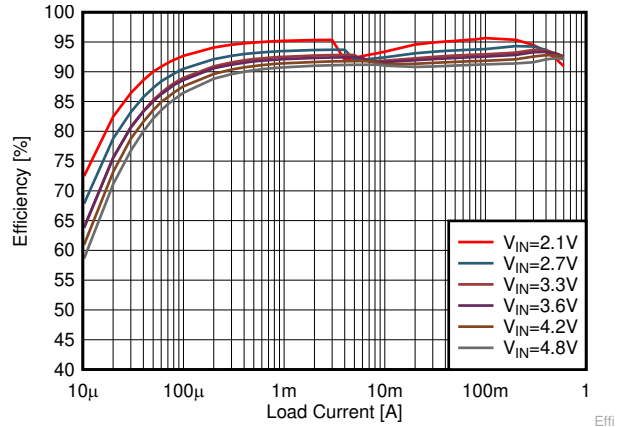

TPS62808 $V_{OUT} = 1.8\text{ V}$, VSEL/MODE = GND
L = 1- μH DFE201610E

图 9-13. Efficiency Power Save Mode
 $V_{OUT} = 1.8\text{ V}$

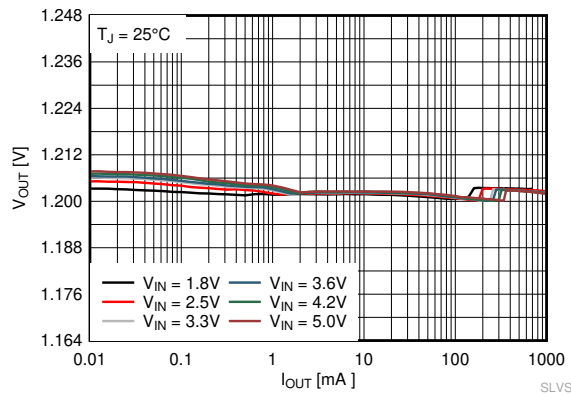

TPS62801 VSEL/MODE = GND
 $V_{OUT} = 1.2\text{ V}$ PFM/PWM mode $T_J = 25^\circ\text{C}$

图 9-14. Output Voltage vs Output Current

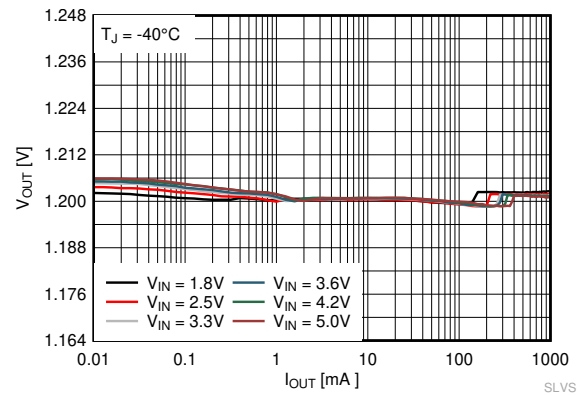

TPS62801 VSEL/MODE = GND
 $V_{OUT} = 1.2\text{ V}$ PFM/PWM mode $T_J = -40^\circ\text{C}$

图 9-15. Output Voltage vs Output Current

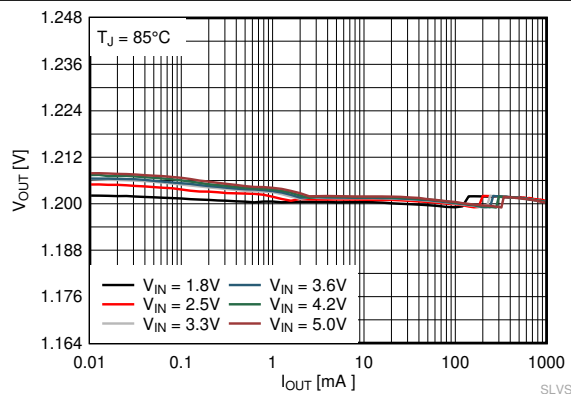

TPS62801 VSEL/MODE = GND
 $V_{OUT} = 1.2\text{ V}$ PFM/PWM mode $T_J = 85^\circ\text{C}$

图 9-16. Output Voltage vs Output Current

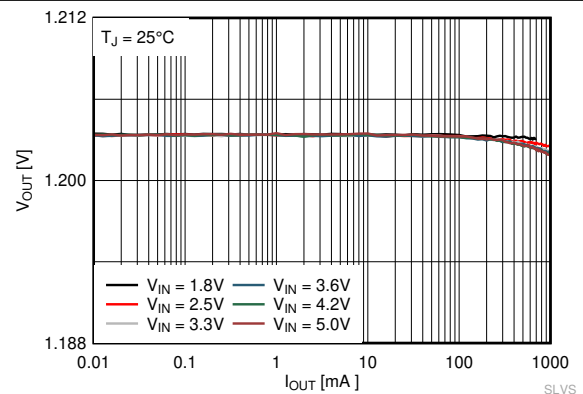

TPS62801 VSEL/MODE = high after start-up
 $V_{OUT} = 1.2\text{ V}$ Forced PWM mode $T_J = 25^\circ\text{C}$

图 9-17. Output Voltage vs Output Current

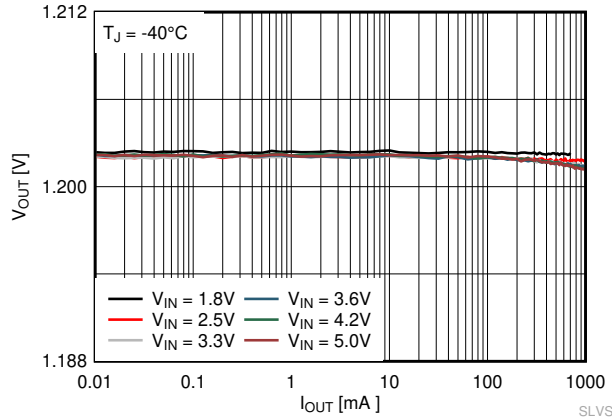

TPS62801 VSEL/MODE = high after start-up
 $V_{OUT} = 1.2\text{ V}$ Forced PWM mode $T_J = -40^\circ\text{C}$

图 9-18. Output Voltage vs Output Current

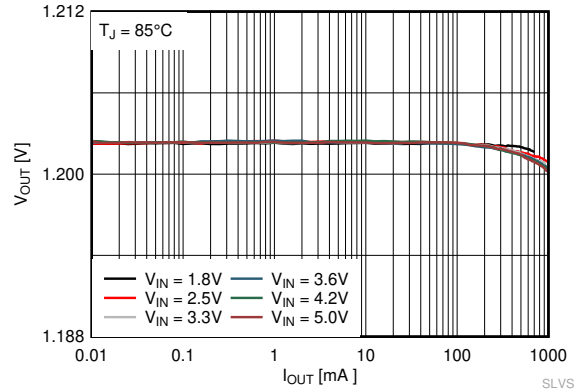

TPS62801 VSEL/MODE = high after start-up
 $V_{OUT} = 1.2\text{ V}$ Forced PWM mode $T_J = 85^\circ\text{C}$

图 9-19. Output Voltage vs Output Current

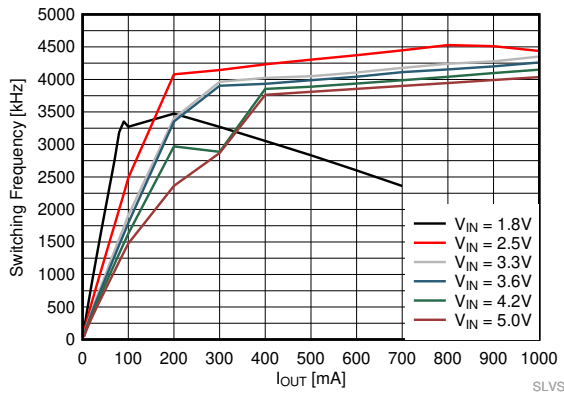

TPS62801 VSEL/MODE = GND
 $V_{OUT} = 1.2\text{ V}$ PFM/PWM mode $T_J = 25^\circ\text{C}$

图 9-20. Switching Frequency vs Output Current

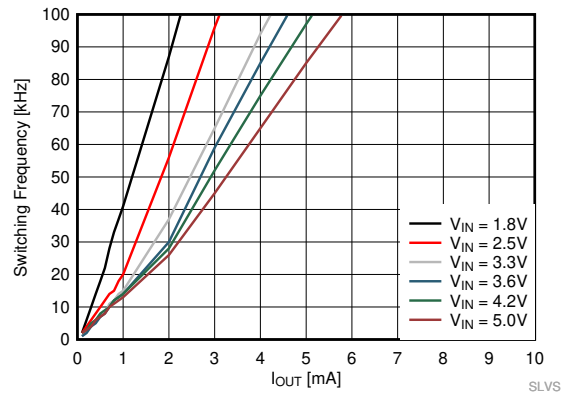

TPS62801 VSEL/MODE = GND
 $V_{OUT} = 1.2\text{ V}$ PFM/PWM mode $T_J = 25^\circ\text{C}$

图 9-21. Switching Frequency (Zoom In)

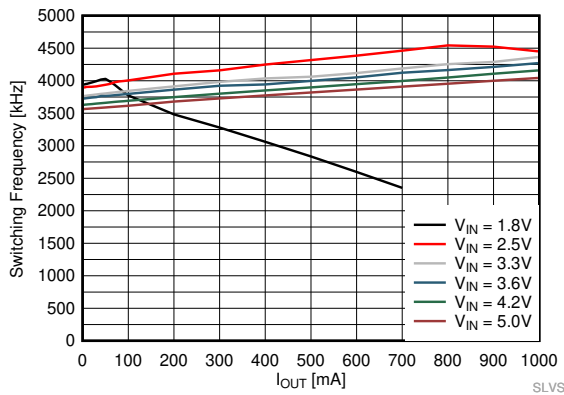

TPS62801 VSEL/MODE = high after start-up
 $V_{OUT} = 1.2\text{ V}$ Forced PWM Mode $T_J = 25^\circ\text{C}$

图 9-22. Switching Frequency vs Output Current

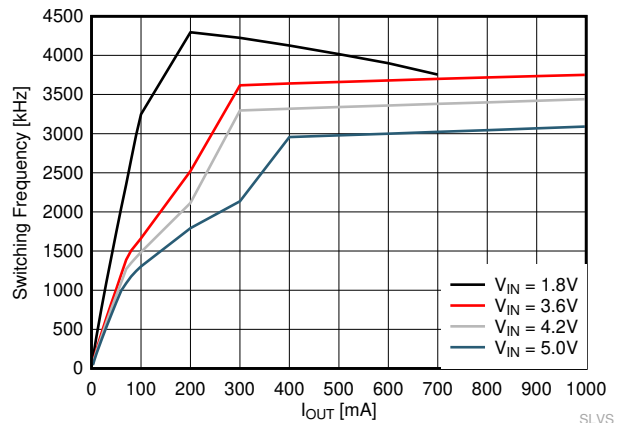

TPS62801 VSEL/MODE = 10 kΩ to GND
 $V_{OUT} = 0.8\text{ V}$ PFM/PWM mode $T_J = 25^\circ\text{C}$

图 9-23. Switching Frequency vs Output Current



图 9-24. Switching Frequency vs Output Current



图 9-25. Typical Operation Power Save Mode

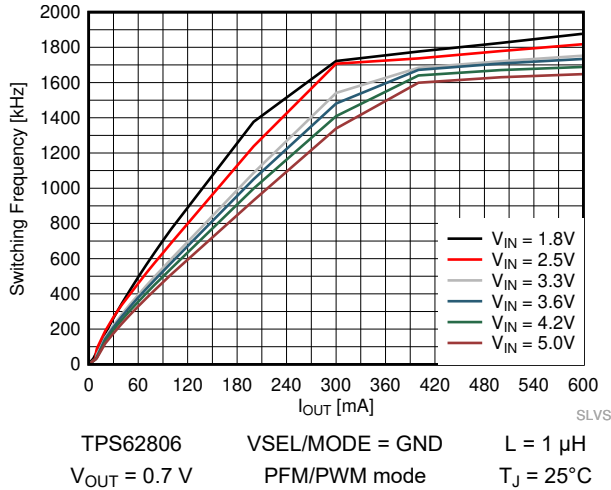

图 9-26. Typical Operation Power Save Mode

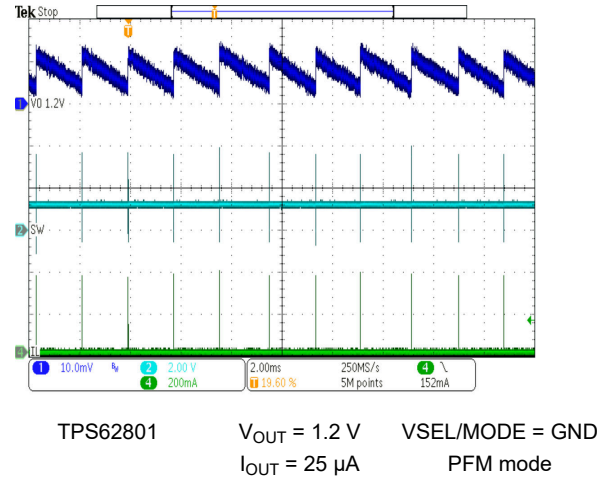

图 9-27. TPS62806 Typical Operation Power Save Mode

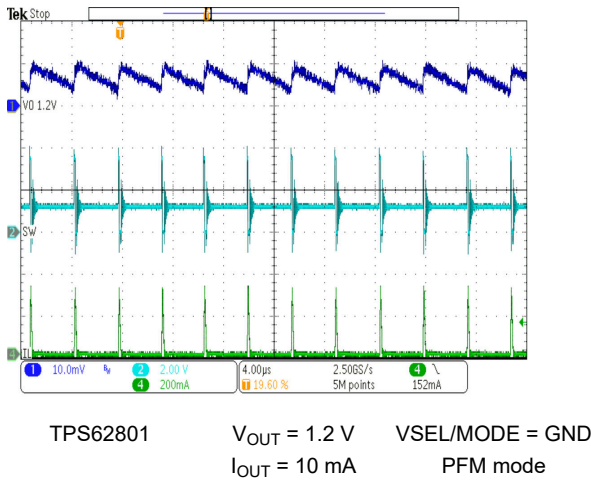

图 9-28. TPS62806 Typical Forced PWM Mode Operation (1.5 MHz)

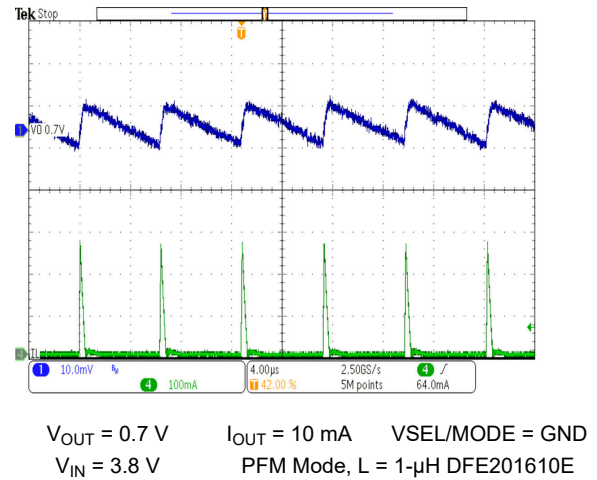

图 9-29. TPS62801 Typical Operation PWM Mode

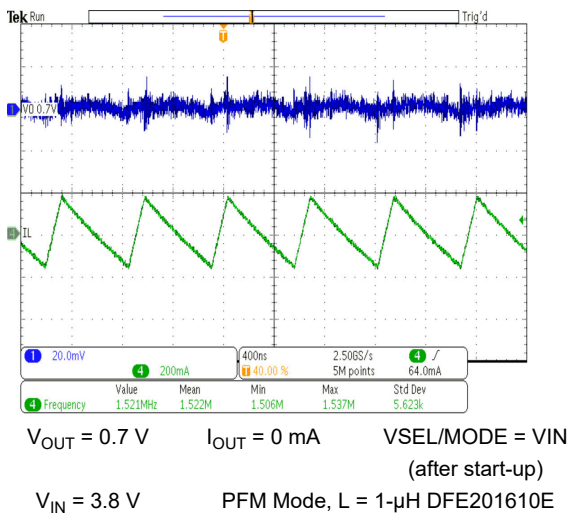

图 9-30. TPS62801 Typical Operation Forced PWM Mode

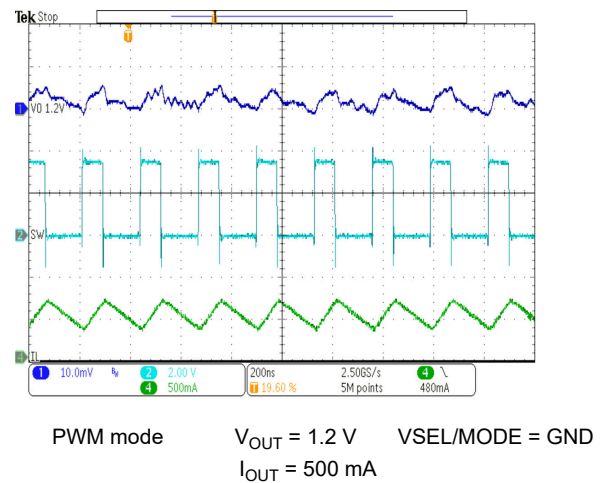

图 9-31. Load Transient Power Save Mode

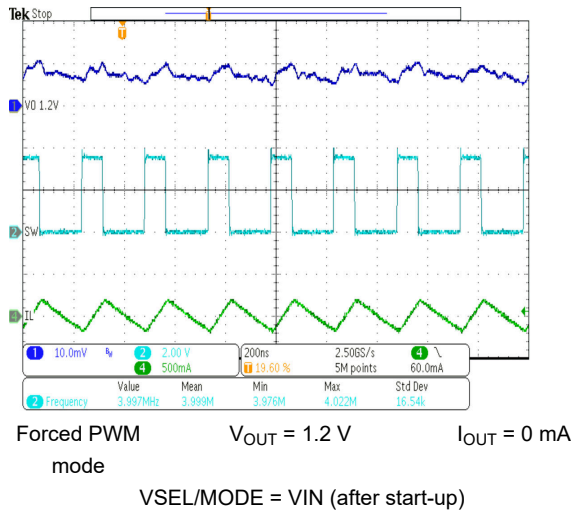

图 9-32. Load Transient Power Save Mode

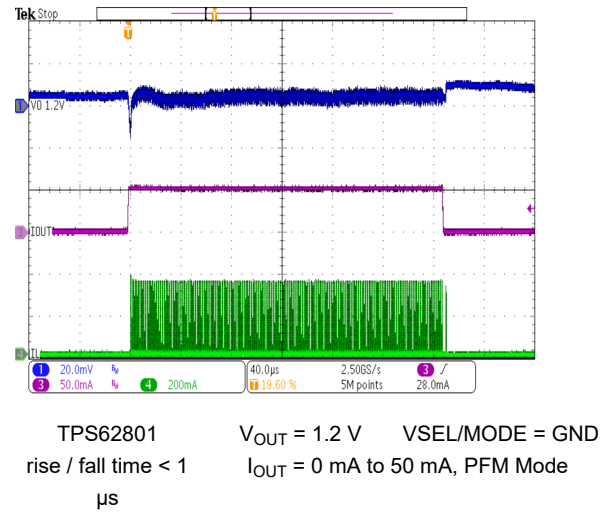

图 9-33. TPS62801 Load Transient Forced PWM Mode

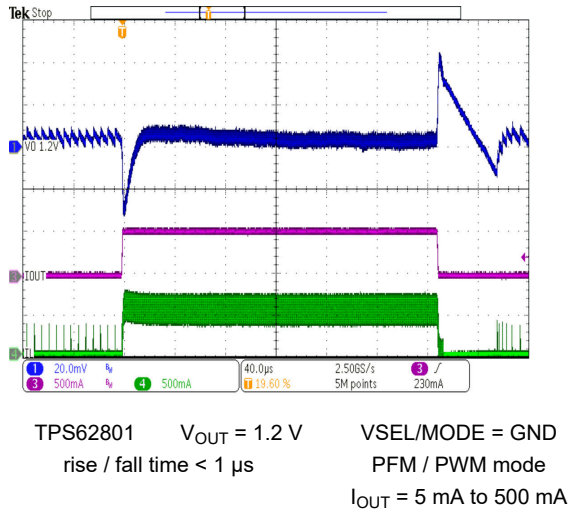

TPS62801 $V_{OUT} = 1.2\text{ V}$ $V_{SEL}/MODE = GND$
 $I_{OUT} = 1\text{ mA to }1\text{ A }1\text{ kHz}$ $PFM/PWM\text{ mode}$

图 9-34. AC Load Sweep Power Save Mode

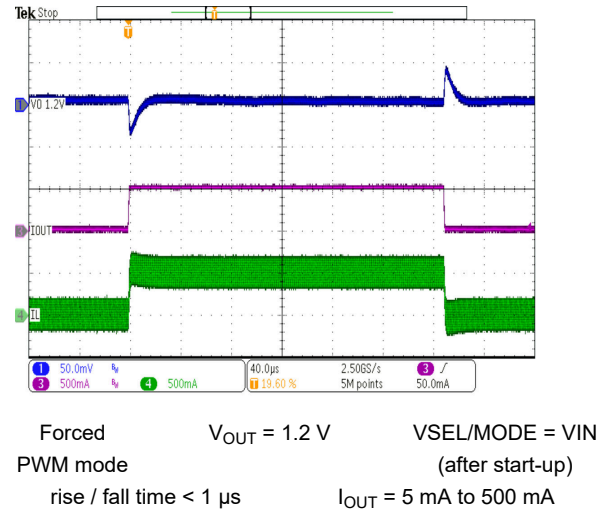
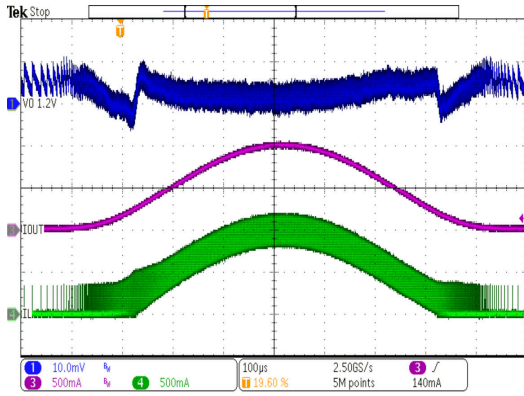
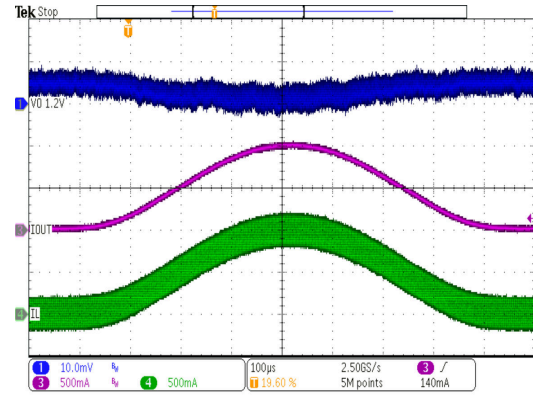

TPS62801 $V_{OUT} = 1.2\text{ V}$ $V_{SEL}/MODE = VIN$
 $I_{OUT} = 1\text{ mA to }1\text{ A, }1\text{ kHz}$ (after start-up)
 $Forced\ PWM\ mode$

图 9-35. AC Load Sweep Forced PWM Mode

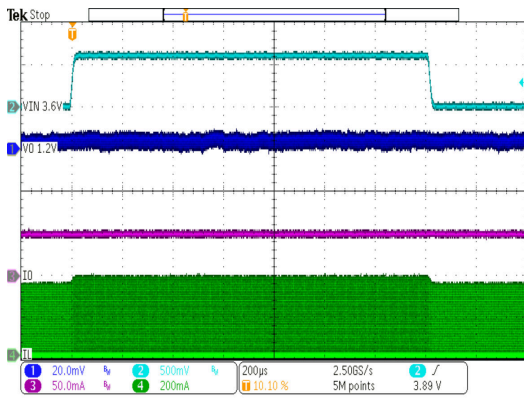

TPS62801 $V_{OUT} = 1.2\text{ V}$ $V_{IN} = 3.6\text{ V to }4.2\text{ V}$
 $\text{rise / fall time} = 10\ \mu\text{s}$ $I_{OUT} = 50\text{ mA}$

图 9-36. Line Transient PFM Mode

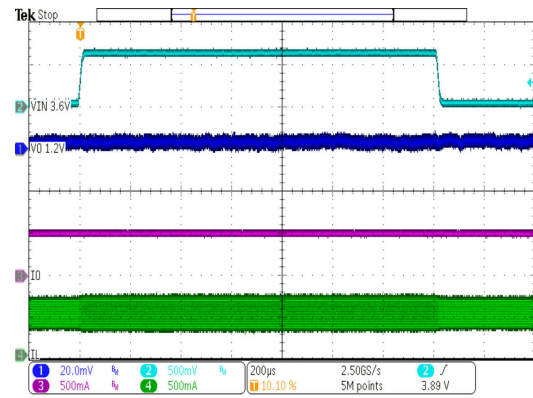

TPS62801 $V_{OUT} = 1.2\text{ V}$ $V_{IN} = 3.6\text{ V to }4.2\text{ V}$
 $\text{rise / fall time} = 10\ \mu\text{s}$ $I_{OUT} = 500\text{ mA}$

图 9-37. Line Transient PWM Mode

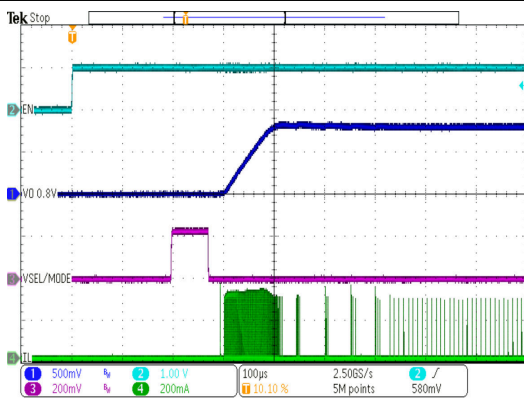

$V_{OUT} = 0.8\text{ V}$ $V_{SEL}/MODE = \text{Low (through } R_{VSEL})$
 $R_{VSEL} = 10\text{ k}\Omega$ $R_{Load} = 220\ \Omega$

图 9-38. TPS62801 Start-Up, $V_{OUT} = 0.8\text{ V}$

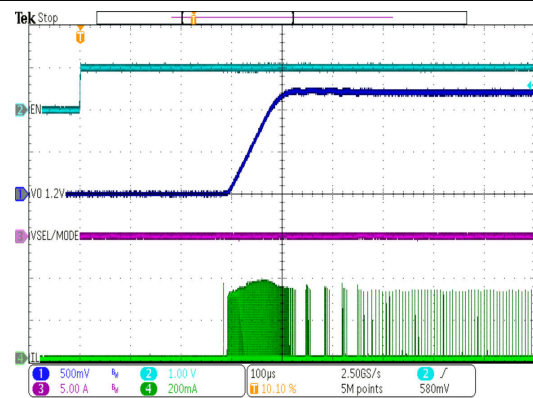

TPS62801 $V_{OUT} = 1.2\text{ V}$ $V_{SEL}/MODE = GND$
 $R_{Load} = 220\ \Omega$

图 9-39. Start-Up, $V_{OUT} = 1.2\text{ V}$



图 9-40. TPS62801 Start-Up, $V_{OUT} = 1.55\text{ V}$



图 9-41. Output Discharge

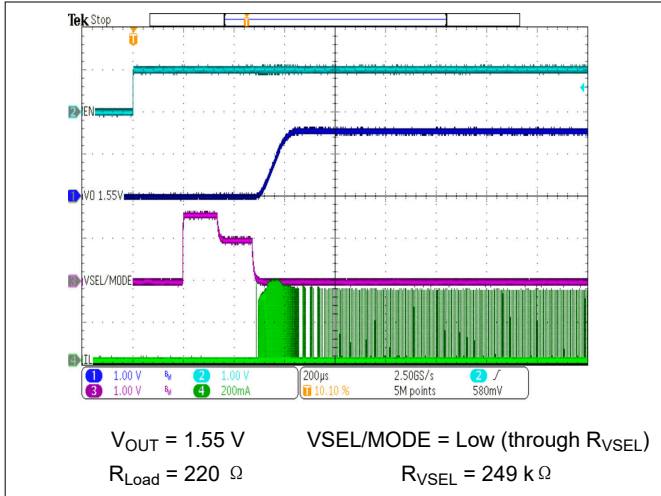

图 9-42. Start-Up Delay Time, $V_{SEL} = 0$

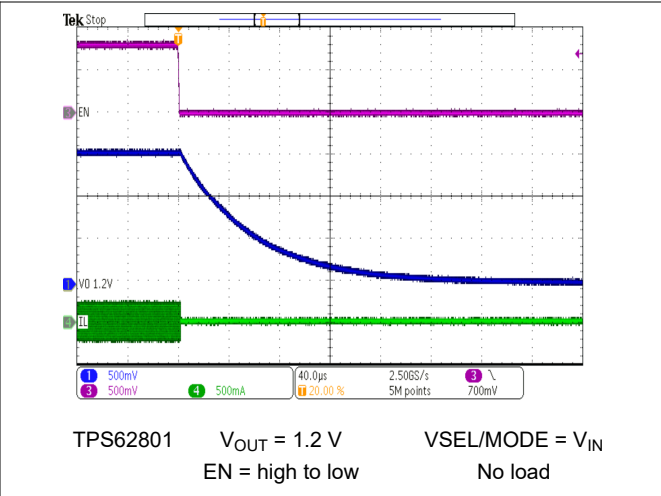

图 9-43. Start-Up Delay Time, $V_{SEL} = 1$

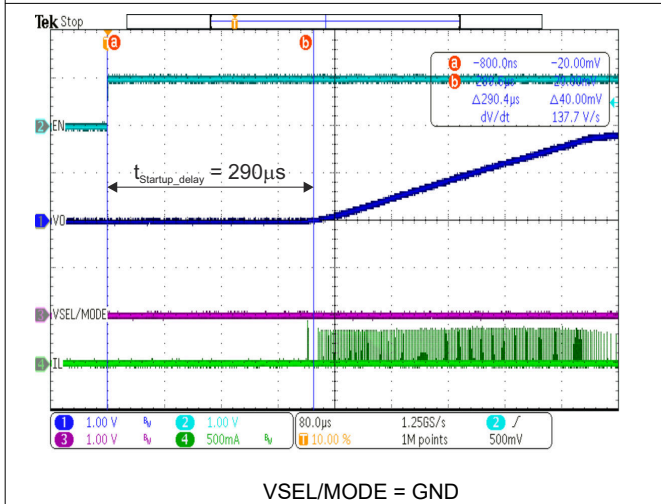

图 9-44. Start-Up Delay Time, $V_{SEL} = 7$

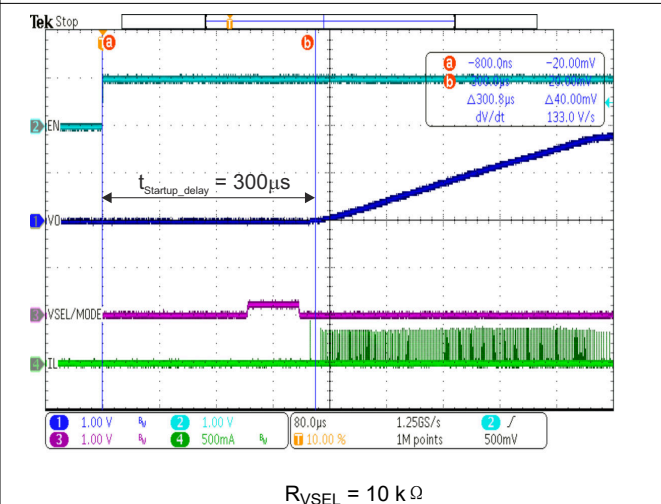

图 9-45. Start-Up Delay Time, $V_{SEL} = 8$

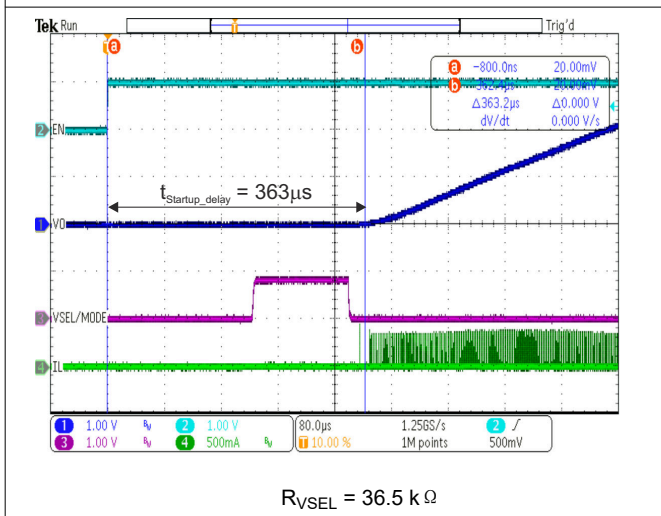

9.3 System Examples

This section shows additional circuits for various output voltages.

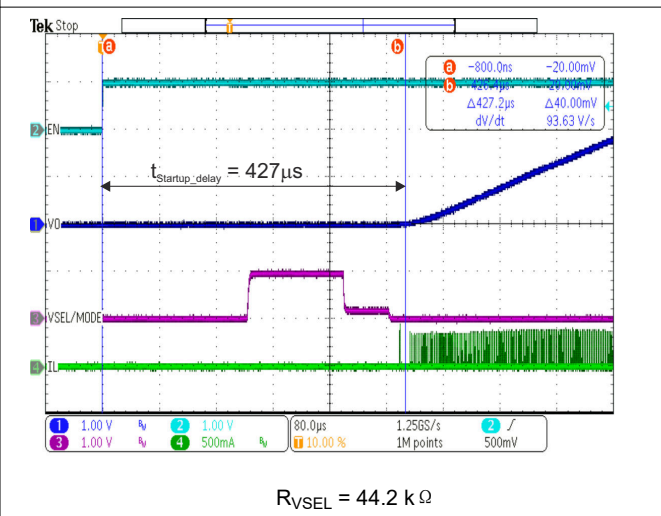
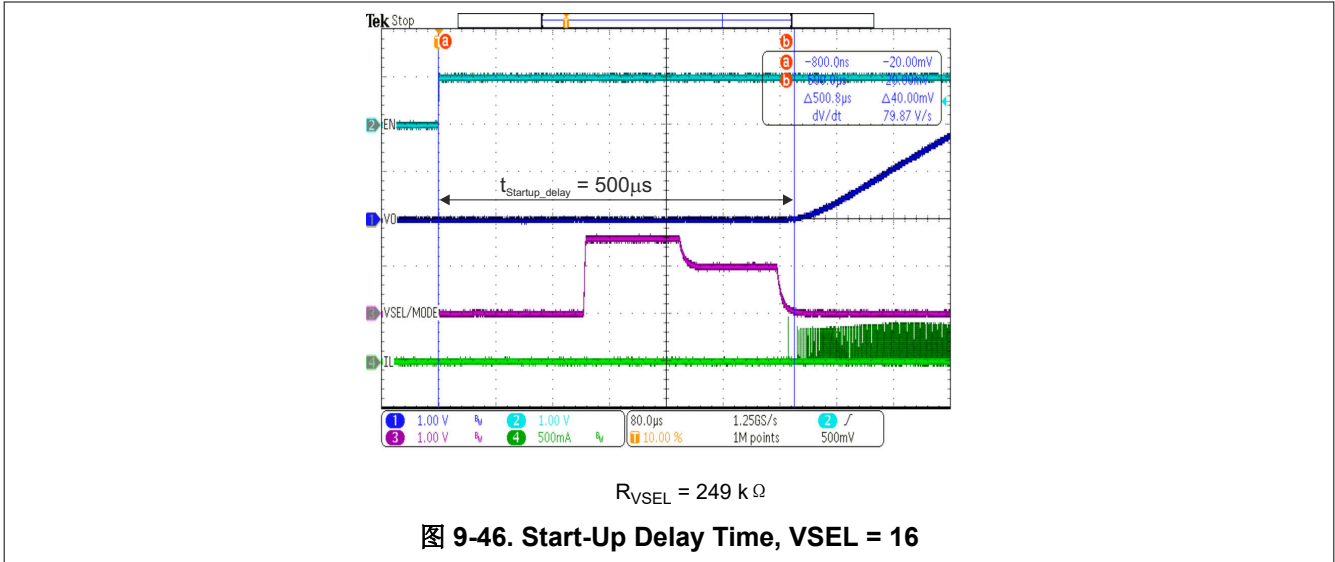

图 9-47. TPS62801 VSEL Connected to GND for 1.2-V Fixed V_{OUT}



图 9-48. TPS62801 Adjustable V_{OUT} Application Circuit

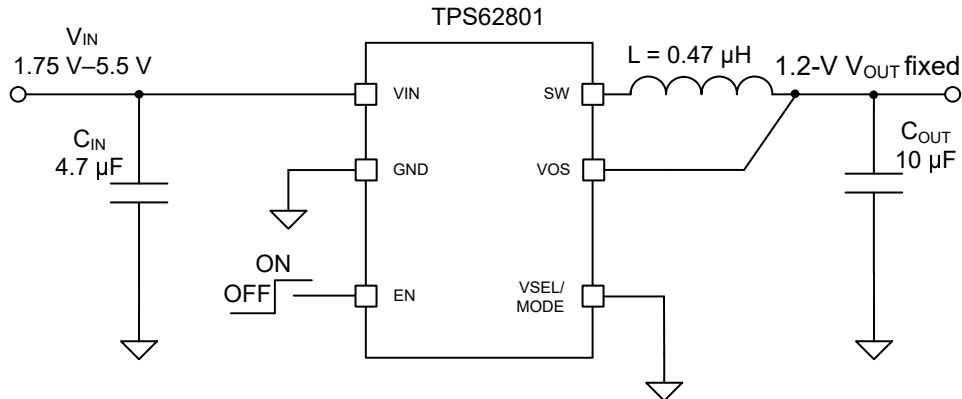

图 9-49. TPS62802 Adjustable 3.3-V V_{OUT} Application Circuit

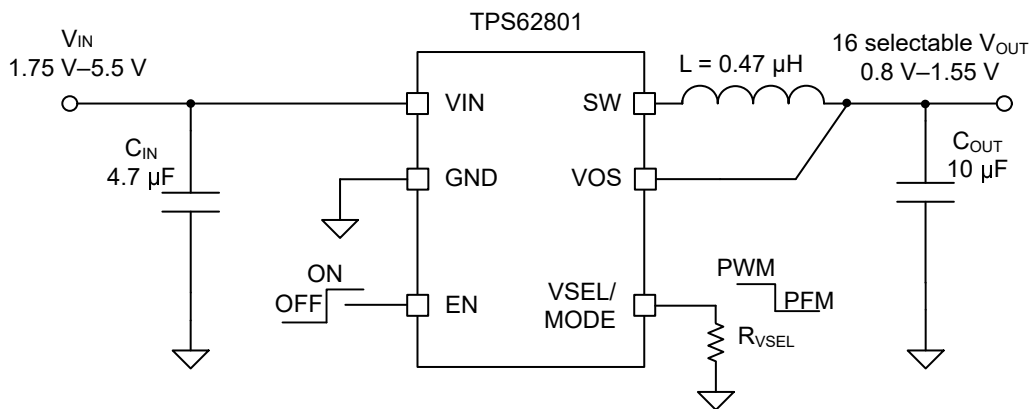

图 9-50. TPS62802 VSEL Connected to GND for 1.8-V Fixed V_{OUT}

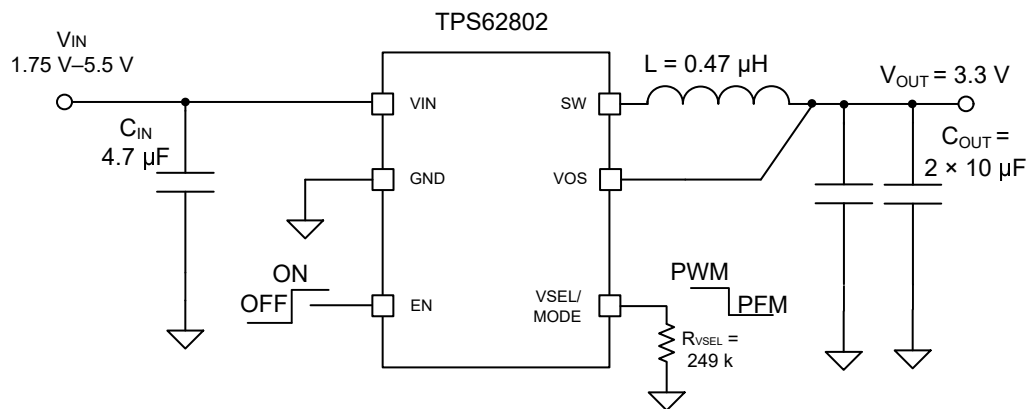

图 9-51. TPS62806 Adjustable V_{OUT} Application Circuit

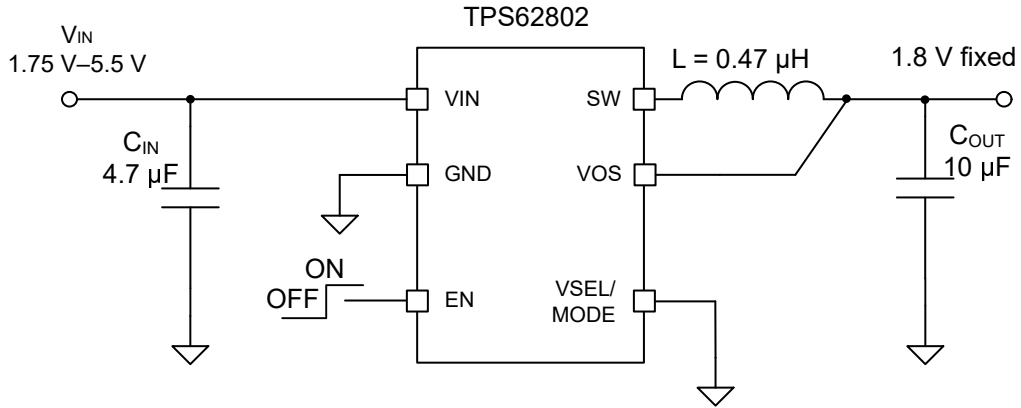

图 9-52. TPS62806 VSEL Connected to GND for 0.7-V Fixed V_{OUT}

10 Power Supply Recommendations

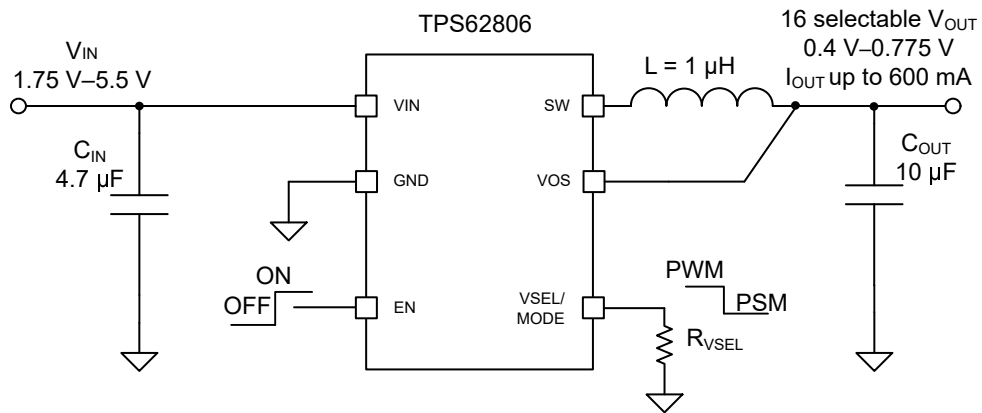
The power supply must provide a current rating according to the supply voltage, output voltage, and output current of the TPS6280x.

11 Layout

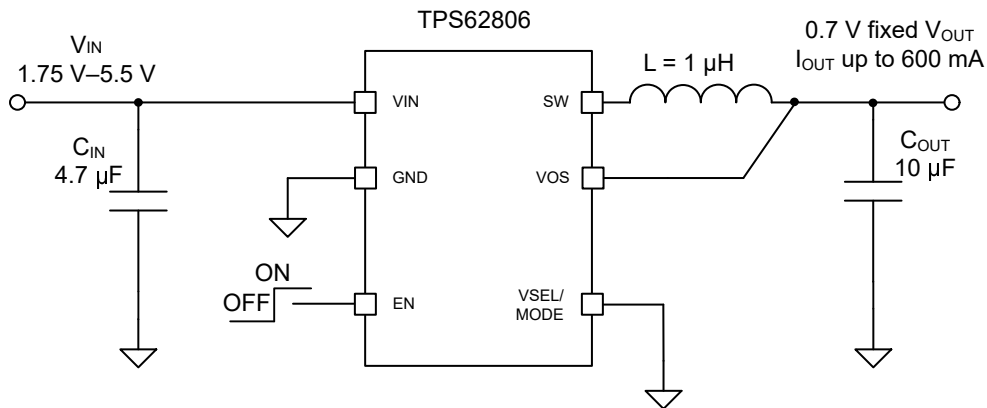
11.1 Layout Guidelines

The pinout of TPS6280x has been optimized to enable a single top layer PCB routing of the IC and its critical passive components such as C_{IN} , C_{OUT} , and L. Furthermore, this pinout allows the user to connect tiny components such as 0201 (0603) size capacitors and a 0402 (1005) size inductor. A solution size smaller than 5 mm² can be achieved with a fixed output voltage.

- As for all switching power supplies, the layout is an important step in the design. Take care in board layout to get the specified performance.
- It is critical to provide a low inductance, low impedance ground path. Therefore, use wide and short traces for the main current paths.
- The input capacitor should be placed as close as possible to the VIN and GND pins of the IC. This is the most critical component placement.
- The VOS line is a sensitive, high impedance line and should be connected to the output capacitor and routed away from noisy components and traces (for example, SW line) or other noise sources.

11.2 Layout Example



图 11-1. PCB Layout Example

12 Device and Documentation Support

12.1 Device Support

12.1.1 第三方产品免责声明

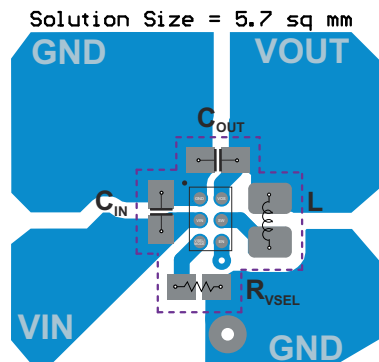
TI 发布的与第三方产品或服务有关的信息，不能构成与此类产品或服务或保修的适用性有关的认可，不能构成此类产品或服务单独或与任何 TI 产品或服务一起的表示或认可。

12.1.2 Development Support

12.1.2.1 Custom Design With WEBENCH® Tools

[Click here](#) to create a custom design using the TPS62800 device with the WEBENCH® Power Designer.

[Click here](#) to create a custom design using the TPS62801 device with the WEBENCH® Power Designer.

[Click here](#) to create a custom design using the TPS62802 device with the WEBENCH® Power Designer.

[Click here](#) to create a custom design using the TPS62806 device with the WEBENCH® Power Designer.

[Click here](#) to create a custom design using the TPS62807 device with the WEBENCH® Power Designer.

[Click here](#) to create a custom design using the TPS62808 device with the WEBENCH® Power Designer.

1. Start by entering the input voltage (V_{IN}), output voltage (V_{OUT}), and output current (I_{OUT}) requirements.
2. Optimize the design for key parameters such as efficiency, footprint, and cost using the optimizer dial.
3. Compare the generated design with other possible solutions from Texas Instruments.

The WEBENCH Power Designer provides a customized schematic along with a list of materials with real-time pricing and component availability.

In most cases, these actions are available:

- Run electrical simulations to see important waveforms and circuit performance
- Run thermal simulations to understand board thermal performance
- Export customized schematic and layout into popular CAD formats
- Print PDF reports for the design, and share the design with colleagues

Get more information about WEBENCH tools at www.ti.com/WBENCH.

12.2 接收文档更新通知

要接收文档更新通知，请导航至 ti.com 上的器件产品文件夹。点击 [订阅更新](#) 进行注册，即可每周接收产品信息更改摘要。有关更改的详细信息，请查看任何已修订文档中包含的修订历史记录。

12.3 支持资源

[TI E2E™ 支持论坛](#) 是工程师的重要参考资料，可直接从专家获得快速、经过验证的解答和设计帮助。搜索现有解答或提出自己的问题可获得所需的快速设计帮助。

链接的内容由各个贡献者“按原样”提供。这些内容并不构成 TI 技术规范，并且不一定反映 TI 的观点；请参阅 TI 的 [《使用条款》](#)。

12.4 Trademarks

DCS-Control™ and TI E2E™ are trademarks of Texas Instruments.

WEBENCH® is a registered trademark of Texas Instruments.

所有商标均为其各自所有者的财产。

12.5 Electrostatic Discharge Caution



This integrated circuit can be damaged by ESD. Texas Instruments recommends that all integrated circuits be handled with appropriate precautions. Failure to observe proper handling and installation procedures can cause damage.

ESD damage can range from subtle performance degradation to complete device failure. Precision integrated circuits may be more susceptible to damage because very small parametric changes could cause the device not to meet its published specifications.

12.6 术语表

[TI 术语表](#) 本术语表列出并解释了术语、首字母缩略词和定义。

13 Mechanical, Packaging, and Orderable Information

The following pages include mechanical, packaging, and orderable information. This information is the most current data available for the designated devices. This data is subject to change without notice and revision of this document. For browser-based versions of this data sheet, refer to the left-hand navigation.

PACKAGING INFORMATION

Orderable Device	Status (1)	Package Type	Package Drawing	Pins	Package Qty	Eco Plan (2)	Lead finish/ Ball material (6)	MSL Peak Temp (3)	Op Temp (°C)	Device Marking (4/5)	Samples
TPS62800YKAR	ACTIVE	DSBGA	YKA	6	3000	RoHS & Green	SAC396 SNAGCU	Level-1-260C-UNLIM	-40 to 125	-	Samples
TPS62801YKAR	ACTIVE	DSBGA	YKA	6	3000	RoHS & Green	SAC396 SNAGCU	Level-1-260C-UNLIM	-40 to 125	+	Samples
TPS62801YKAT	ACTIVE	DSBGA	YKA	6	250	RoHS & Green	SAC396 SNAGCU	Level-1-260C-UNLIM	-40 to 125	+	Samples
TPS62802YKAR	ACTIVE	DSBGA	YKA	6	3000	RoHS & Green	SAC396 SNAGCU	Level-1-260C-UNLIM	-40 to 125	X	Samples
TPS62802YKAT	ACTIVE	DSBGA	YKA	6	250	RoHS & Green	SAC396 SNAGCU	Level-1-260C-UNLIM	-40 to 125	X	Samples
TPS62806YKAR	ACTIVE	DSBGA	YKA	6	3000	RoHS & Green	SAC396 SNAGCU	Level-1-260C-UNLIM	-40 to 125	J	Samples
TPS62806YKAT	ACTIVE	DSBGA	YKA	6	250	RoHS & Green	SAC396 SNAGCU	Level-1-260C-UNLIM	-40 to 125	J	Samples
TPS62807YKAR	ACTIVE	DSBGA	YKA	6	3000	RoHS & Green	SAC396 SNAGCU	Level-1-260C-UNLIM	-40 to 125	L	Samples
TPS62807YKAT	ACTIVE	DSBGA	YKA	6	250	RoHS & Green	SAC396 SNAGCU	Level-1-260C-UNLIM	-40 to 125	L	Samples
TPS62808YKAR	ACTIVE	DSBGA	YKA	6	3000	RoHS & Green	SAC396 SNAGCU	Level-1-260C-UNLIM	-40 to 125	V	Samples

(1) The marketing status values are defined as follows:

ACTIVE: Product device recommended for new designs.

LIFEBUY: TI has announced that the device will be discontinued, and a lifetime-buy period is in effect.

NRND: Not recommended for new designs. Device is in production to support existing customers, but TI does not recommend using this part in a new design.

PREVIEW: Device has been announced but is not in production. Samples may or may not be available.

OBSOLETE: TI has discontinued the production of the device.

(2) **RoHS:** TI defines "RoHS" to mean semiconductor products that are compliant with the current EU RoHS requirements for all 10 RoHS substances, including the requirement that RoHS substance do not exceed 0.1% by weight in homogeneous materials. Where designed to be soldered at high temperatures, "RoHS" products are suitable for use in specified lead-free processes. TI may reference these types of products as "Pb-Free".

RoHS Exempt: TI defines "RoHS Exempt" to mean products that contain lead but are compliant with EU RoHS pursuant to a specific EU RoHS exemption.

Green: TI defines "Green" to mean the content of Chlorine (Cl) and Bromine (Br) based flame retardants meet JS709B low halogen requirements of <=1000ppm threshold. Antimony trioxide based flame retardants must also meet the <=1000ppm threshold requirement.

(3) MSL, Peak Temp. - The Moisture Sensitivity Level rating according to the JEDEC industry standard classifications, and peak solder temperature.

(4) There may be additional marking, which relates to the logo, the lot trace code information, or the environmental category on the device.

⁽⁵⁾ Multiple Device Markings will be inside parentheses. Only one Device Marking contained in parentheses and separated by a "~" will appear on a device. If a line is indented then it is a continuation of the previous line and the two combined represent the entire Device Marking for that device.

⁽⁶⁾ Lead finish/Ball material - Orderable Devices may have multiple material finish options. Finish options are separated by a vertical ruled line. Lead finish/Ball material values may wrap to two lines if the finish value exceeds the maximum column width.

Important Information and Disclaimer:The information provided on this page represents TI's knowledge and belief as of the date that it is provided. TI bases its knowledge and belief on information provided by third parties, and makes no representation or warranty as to the accuracy of such information. Efforts are underway to better integrate information from third parties. TI has taken and continues to take reasonable steps to provide representative and accurate information but may not have conducted destructive testing or chemical analysis on incoming materials and chemicals. TI and TI suppliers consider certain information to be proprietary, and thus CAS numbers and other limited information may not be available for release.

In no event shall TI's liability arising out of such information exceed the total purchase price of the TI part(s) at issue in this document sold by TI to Customer on an annual basis.

TAPE AND REEL INFORMATION

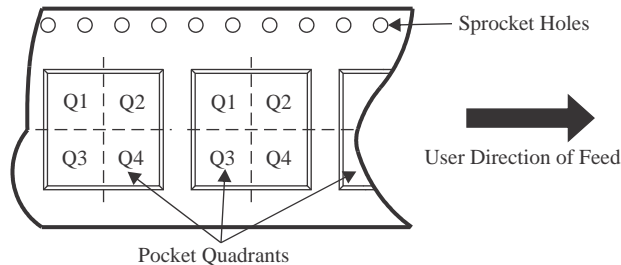
QUADRANT ASSIGNMENTS FOR PIN 1 ORIENTATION IN TAPE

*All dimensions are nominal

Device	Package Type	Package Drawing	Pins	SPQ	Reel Diameter (mm)	Reel Width W1 (mm)	A0 (mm)	B0 (mm)	K0 (mm)	P1 (mm)	W (mm)	Pin1 Quadrant
TPS62800YKAR	DSBGA	YKA	6	3000	180.0	8.4	0.81	1.16	0.46	4.0	8.0	Q1
TPS62801YKAR	DSBGA	YKA	6	3000	180.0	8.4	0.81	1.16	0.46	4.0	8.0	Q1
TPS62801YKAR	DSBGA	YKA	6	3000	178.0	8.4	0.81	1.16	0.46	4.0	8.0	Q1
TPS62801YKAT	DSBGA	YKA	6	250	180.0	8.4	0.81	1.16	0.46	4.0	8.0	Q1
TPS62801YKAT	DSBGA	YKA	6	250	178.0	8.4	0.81	1.16	0.46	4.0	8.0	Q1
TPS62802YKAR	DSBGA	YKA	6	3000	180.0	8.4	0.81	1.16	0.46	4.0	8.0	Q1
TPS62802YKAR	DSBGA	YKA	6	3000	178.0	8.4	0.81	1.16	0.46	4.0	8.0	Q1
TPS62802YKAT	DSBGA	YKA	6	250	180.0	8.4	0.81	1.16	0.46	4.0	8.0	Q1
TPS62806YKAR	DSBGA	YKA	6	3000	180.0	8.4	0.81	1.16	0.46	4.0	8.0	Q1
TPS62806YKAT	DSBGA	YKA	6	250	178.0	8.4	0.81	1.16	0.46	4.0	8.0	Q1
TPS62806YKAT	DSBGA	YKA	6	250	180.0	8.4	0.81	1.16	0.46	4.0	8.0	Q1
TPS62807YKAR	DSBGA	YKA	6	3000	180.0	8.4	0.81	1.16	0.46	4.0	8.0	Q1
TPS62807YKAR	DSBGA	YKA	6	3000	178.0	8.4	0.81	1.16	0.46	4.0	8.0	Q1
TPS62807YKAT	DSBGA	YKA	6	250	178.0	8.4	0.81	1.16	0.46	4.0	8.0	Q1
TPS62807YKAT	DSBGA	YKA	6	250	180.0	8.4	0.81	1.16	0.46	4.0	8.0	Q1
TPS62808YKAR	DSBGA	YKA	6	3000	180.0	8.4	0.81	1.16	0.46	4.0	8.0	Q1

TAPE AND REEL BOX DIMENSIONS

*All dimensions are nominal

Device	Package Type	Package Drawing	Pins	SPQ	Length (mm)	Width (mm)	Height (mm)
TPS62800YKAR	DSBGA	YKA	6	3000	182.0	182.0	20.0
TPS62801YKAR	DSBGA	YKA	6	3000	182.0	182.0	20.0
TPS62801YKAR	DSBGA	YKA	6	3000	220.0	220.0	35.0
TPS62801YKAT	DSBGA	YKA	6	250	182.0	182.0	20.0
TPS62801YKAT	DSBGA	YKA	6	250	220.0	220.0	35.0
TPS62802YKAR	DSBGA	YKA	6	3000	182.0	182.0	20.0
TPS62802YKAR	DSBGA	YKA	6	3000	220.0	220.0	35.0
TPS62802YKAT	DSBGA	YKA	6	250	182.0	182.0	20.0
TPS62806YKAR	DSBGA	YKA	6	3000	182.0	182.0	20.0
TPS62806YKAT	DSBGA	YKA	6	250	220.0	220.0	35.0
TPS62806YKAT	DSBGA	YKA	6	250	182.0	182.0	20.0
TPS62807YKAR	DSBGA	YKA	6	3000	182.0	182.0	20.0
TPS62807YKAR	DSBGA	YKA	6	3000	220.0	220.0	35.0
TPS62807YKAT	DSBGA	YKA	6	250	220.0	220.0	35.0
TPS62807YKAT	DSBGA	YKA	6	250	182.0	182.0	20.0
TPS62808YKAR	DSBGA	YKA	6	3000	182.0	182.0	20.0

YKA0006

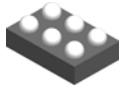

PACKAGE OUTLINE

DSBGA - 0.4 mm max height

DIE SIZE BALL GRID ARRAY

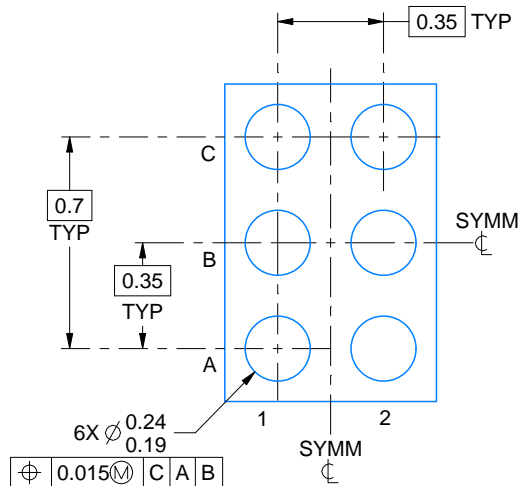
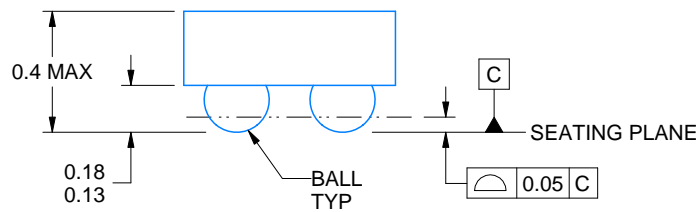
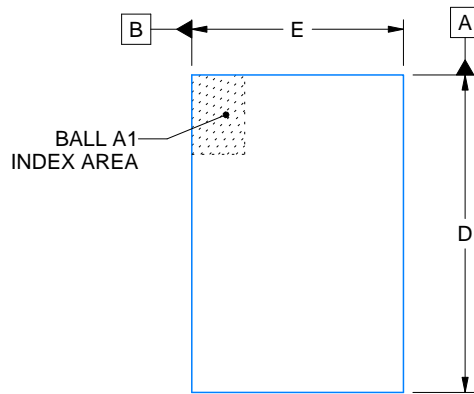

D: Max = 1.084 mm, Min =1.024 mm
E: Max = 0.734 mm, Min =0.674 mm

4223607/A 03/2017

NOTES:

NanoFree Is a trademark of Texas Instruments.

1. All linear dimensions are in millimeters. Any dimensions in parenthesis are for reference only. Dimensioning and tolerancing per ASME Y14.5M.
2. This drawing is subject to change without notice.
3. NanoFree™ package configuration.

EXAMPLE BOARD LAYOUT

YKA0006

DSBGA - 0.4 mm max height

DIE SIZE BALL GRID ARRAY

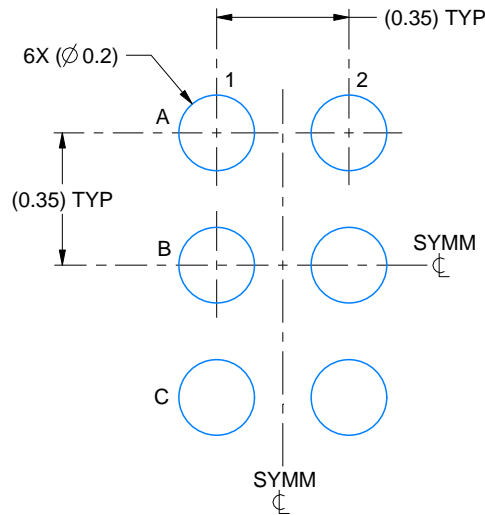

LAND PATTERN EXAMPLE
EXPOSED METAL SHOWN
SCALE:50X

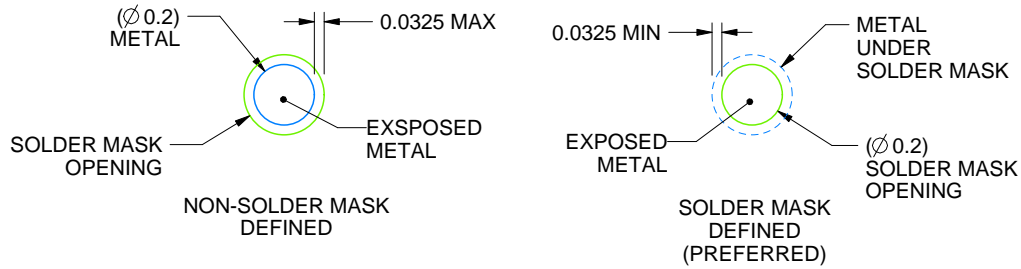

SOLDER MASK DETAILS
NOT TO SCALE

4223607/A 03/2017

NOTES: (continued)

- Final dimensions may vary due to manufacturing tolerance considerations and also routing constraints. For more information, see Texas Instruments literature number SNVA009 (www.ti.com/lit/snva009).

EXAMPLE STENCIL DESIGN

YKA0006

DSBGA - 0.4 mm max height

DIE SIZE BALL GRID ARRAY

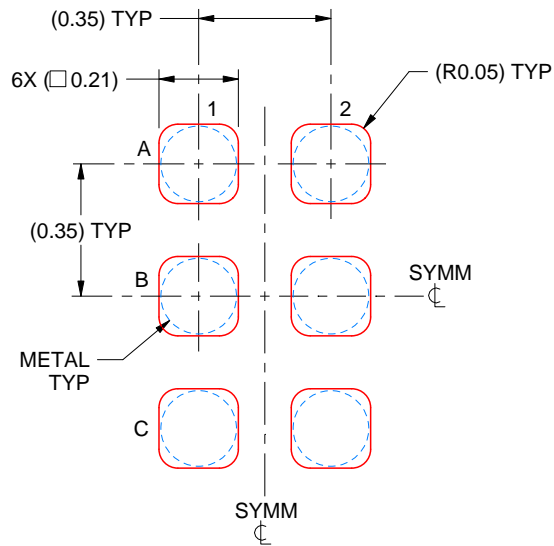

SOLDER PASTE EXAMPLE
BASED ON 0.075 mm - 0.1 mm THICK STENCIL
SCALE:50X

4223607/A 03/2017

NOTES: (continued)

5. Laser cutting apertures with trapezoidal walls and rounded corners may offer better paste release.

重要声明和免责声明

TI“按原样”提供技术和可靠性数据（包括数据表）、设计资源（包括参考设计）、应用或其他设计建议、网络工具、安全信息和其他资源，不保证没有瑕疵且不做任何明示或暗示的担保，包括但不限于对适销性、某特定用途方面的适用性或不侵犯任何第三方知识产权的暗示担保。

这些资源可供使用 TI 产品进行设计的熟练开发人员使用。您将自行承担以下全部责任：(1) 针对您的应用选择合适的 TI 产品，(2) 设计、验证并测试您的应用，(3) 确保您的应用满足相应标准以及任何其他功能安全、信息安全、监管或其他要求。

这些资源如有变更，恕不另行通知。TI 授权您仅可将这些资源用于研发本资源所述的 TI 产品的应用。严禁对这些资源进行其他复制或展示。您无权使用任何其他 TI 知识产权或任何第三方知识产权。您应全额赔偿因在这些资源的使用中对 TI 及其代表造成的任何索赔、损害、成本、损失和债务，TI 对此概不负责。

TI 提供的产品受 [TI 的销售条款](#) 或 [ti.com](#) 上其他适用条款/TI 产品随附的其他适用条款的约束。TI 提供这些资源并不会扩展或以其他方式更改 TI 针对 TI 产品发布的适用的担保或担保免责声明。

TI 反对并拒绝您可能提出的任何其他或不同的条款。

邮寄地址：Texas Instruments, Post Office Box 655303, Dallas, Texas 75265

Copyright © 2023，德州仪器 (TI) 公司

X-ON Electronics

Largest Supplier of Electrical and Electronic Components

Click to view similar products for [Switching Voltage Regulators](#) category:

Click to view products by [Texas Instruments](#) manufacturer:

Other Similar products are found below :

[FAN53610AUC33X](#) [FAN53611AUC123X](#) [EN6310QA](#) [160215](#) [R3](#) [KE177614](#) [FAN53611AUC12X](#) [MAX809TTR](#) [NCV891234MW50R2G](#)
[AST1S31PUR](#) [NCP81203PMNTXG](#) [NCP81208MNTXG](#) [PCA9412AUKZ](#) [NCP81109GMNTXG](#) [NCP3235MNTXG](#) [NCP81109JMNTXG](#)
[NCP81241MNTXG](#) [NTE7223](#) [NTE7222](#) [NTE7224](#) [L6986FTR](#) [MPQ4481GU-AEC1-P](#) [MP8756GD-P](#) [MPQ2171GJ-P](#) [MPQ2171GJ-AEC1-P](#)
[N JW4153U2-A-TE2](#) [MP2171GJ-P](#) [MP28160GC-Z](#) [XDPE132G5CG000XUMA1](#) [LM60440AQRPKRQ1](#) [MP5461GC-P](#) [IW673-20](#)
[NCV896530MWATXG](#) [MPQ4409GQBE-AEC1-P](#) [S-19903DA-A8T1U7](#) [S-19903CA-A6T8U7](#) [S-19903CA-S8T1U7](#) [S-19902BA-A6T8U7](#)
[S-19902CA-A6T8U7](#) [S-19902AA-A6T8U7](#) [S-19903AA-A6T8U7](#) [S-19902AA-S8T1U7](#) [S-19902BA-A8T1U7](#) [AU8310](#)
[LMR23615QDRRRQ1](#) [LMR33630APAQRN XRQ1](#) [LMR33630APCQRN XRQ1](#) [LMR36503R5RPER](#) [LMR36503RFRPER](#)
[LMR36503RS3QRPERQ1](#)