

具有双路可调 350mA/150mA LDO 的 TPS65262-2 4.5V 至 18V 输入电压、3A/1A/1A 输出电流三路同步降压转换器

1 特性

- 工作输入电压范围：4.5V 至 18V
- 反馈基准电压：0.6V ±1%
- 最大连续输出电流：3A/1A/1A
- 600kHz 固定开关频率
- 集成双路 LDO 的输入电压范围为 1.3V 至 18V，连续输出电流为 350mA/150mA
- 针对 Buck1 的可编程软启动时间
- 针对 Buck2 和 Buck3 的固定软启动时间 1ms
- 针对 Buck2 和 Buck3 的内部环路补偿
- 针对每次降压的专用使能引脚
- 支持脉冲跳跃模式 (PSM) 和强制连续电流模式 (FCCM)
- 输出电压电源正常状态指示器
- 热过载保护
- 采用 32 引脚 VQFN (RHB) 5mm × 5mm 封装
- 具有过压保护、过流和短路保护以及过热保护功能

2 应用

- 数字电视 (DTV)
- 机顶盒
- 家庭网关和接入点网络
- 无线路由器
- 安全监控
- POS 机

3 说明

TPS65262-2 是一款具有 3A/1A/1A 输出电流的单片三路同步降压转换器。4.5V 至 18V 的宽输入电源电压范围包括大多数运行自 5、9、12 或 15V 电源总线的中间总线电压。这款转换器具有恒定频率峰值电流模式，专用于简化应用，同时方便设计人员根据目标应用来优化系统。此器件运行在 600kHz 的固定开关频率上。为了减少外部组件数量，已经集成针对 buck2 和 buck3 的环路补偿。buck1 和 buck 2, 3 之间的 180° 异相运行 (buck2 和 buck3 同相运行) 最大限度地减少了对输入滤波器的要求。

TPS65262-2 可通过将 MODE 引脚连接至 GND 进入脉冲跳跃模式 (PSM)，通过将 MODE 引脚驱动为高电平或保持悬空进入强制持续电流模式 (FCC)。PSM 模式通过减少轻负载时的开关损耗来提供高效率，而 FCC 模式可降低噪声灵敏度和射频 (RF) 干扰。

此外，TPS65262 还内置两个低压降线性稳压器 (LDO)，它们的输入电压范围为 1.3V 至 18V，持续输出电流为 350mA/150mA，具有独立使能和可调输出电压。

电源正常引脚在任何输出电压超出稳压范围时被置为有效。

器件信息(1)

器件型号	封装	封装尺寸 (标称值)
TPS65262-2	VQFN (32)	5.00mm × 5.00mm

(1) 要了解所有可用封装，请见数据表末尾的可订购产品附录。

应用电路原理图

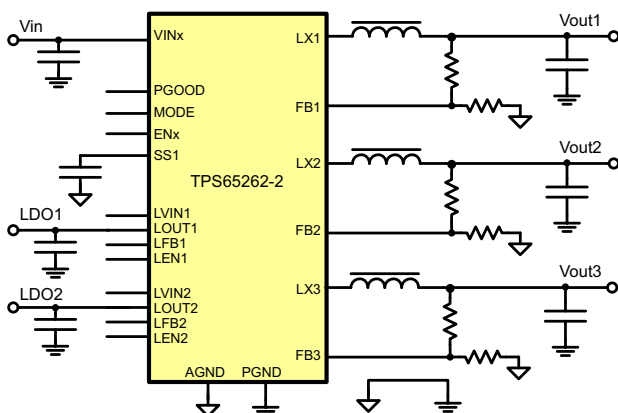

效率与输出负载之间的关系

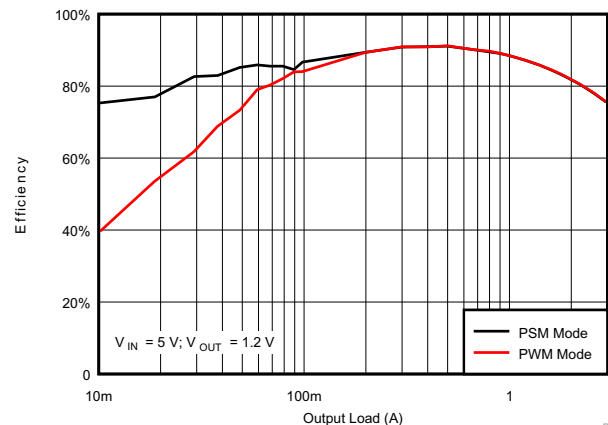

D001



目录

<ul style="list-style-type: none"> 1 特性 1 2 应用 1 3 说明 1 4 修订历史记录 2 5 Pin Configuration and Functions 3 6 Specifications 5 <ul style="list-style-type: none"> 6.1 Absolute Maximum Ratings 5 6.2 ESD Ratings 5 6.3 Recommended Operating Conditions 5 6.4 Thermal Information 5 6.5 Electrical Characteristics 6 6.6 Typical Characteristics 8 7 Detailed Description 12 <ul style="list-style-type: none"> 7.1 Overview 12 7.2 Functional Block Diagram 13 	<ul style="list-style-type: none"> 7.3 Feature Description 13 7.4 Device Functional Modes 20 8 Application and Implementation 21 <ul style="list-style-type: none"> 8.1 Application Information 21 8.2 Typical Application 21 9 Power Supply Recommendations 31 10 Layout 31 <ul style="list-style-type: none"> 10.1 Layout Guidelines 31 10.2 Layout Example 32 11 器件和文档支持 33 <ul style="list-style-type: none"> 11.1 社区资源 33 11.2 商标 33 11.3 静电放电警告 33 11.4 Glossary 33 12 机械、封装和可订购信息 33
----------------------------------------------------------------------------------------------------------------------------------------------------------------------------------------------------------------------------------------------------------------------------------------------------------------------------------------------------------------------------------------------------------------------------------------------------------------------------------------------------------------------------------------------------------------------------------------------------------------------------------------------------------------------------------------------------------------------------------------------------------	--------------------------------------------------------------------------------------------------------------------------------------------------------------------------------------------------------------------------------------------------------------------------------------------------------------------------------------------------------------------------------------------------------------------------------------------------------------------------------------------------------------------------------------------------------------------------------------------------------------------------------------------------------------------------------------------------------------------------------------------------------------------------------------------------------------------------

4 修订历史记录

注：之前版本的页码可能与当前版本有所不同。

Changes from Revision A (December 2015) to Revision B	Page
• Added $T_J = 25^\circ\text{C}$ temperature condition for LDO1 current limit in the <i>Electrical Characteristics</i>	7
• Added $T_J = 25^\circ\text{C}$ temperature condition for LDO2 current limit in the <i>Electrical Characteristics</i>	7

Changes from Original (December 2015) to Revision A	Page
• 将器件状态更新为生产数据.....	1

5 Pin Configuration and Functions

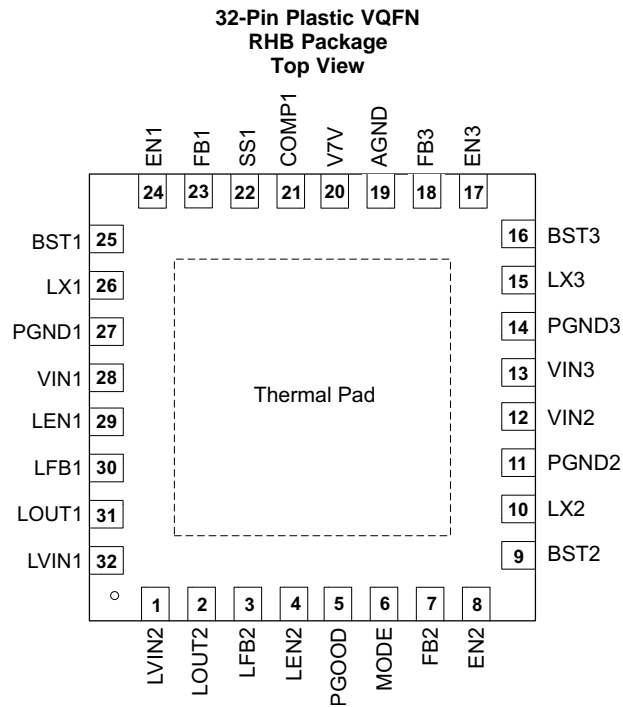

(There is no electric signal down bonded to thermal pad inside IC. Exposed thermal pad must be soldered to PCB for optimal thermal performance.)

Pin Functions

PIN		DESCRIPTION
NAME	NO.	
LVIN2	1	Input power supply for LDO2. Connect LVIN2 pin as close as possible to the (+) terminal of an input ceramic capacitor (suggest 1 μ F).
LOUT2	2	LDO2 output. Connect LOUT2 pin as close as possible to the (+) terminal of an output ceramic capacitor (suggest 1 μ F).
LFB2	3	Feedback Kelvin sensing pin for LDO2 output voltage. Connect this pin to LDO2 resistor divider.
LEN2	4	Enable for LDO2. Float to enable.
PGOOD	5	An open-drain output, asserts low if output voltage of any buck is beyond regulation range due to thermal shutdown, overcurrent, undervoltage, or ENx shut down.
MODE	6	Switch FCC mode and PSM mode. Pull high or leave floating, FCC mode. Pull low, PSM mode.
FB2	7	Feedback Kelvin sensing pin for buck2 output voltage. Connect this pin to buck2 resistor divider.
EN2	8	Enable for buck2. Float to enable. Can use this pin to adjust the input undervoltage lockout of buck2 with a resistor divider.
BST2	9	Boot strapped supply to the high side floating gate driver in Buck2. Connect a capacitor (recommend 47 nF) from BST2 pin to LX2 pin.
LX2	10	Switching node connection to the inductor and bootstrap capacitor for Buck2. The voltage swing at this pin is from a diode voltage below the ground up to VIN2 voltage.
PGND2	11	Power ground connection of Buck2. Connect PGND2 pin as close as possible to the (–) terminal of VIN2 input ceramic capacitor.
VIN2	12	Input power supply for Buck2. Connect VIN2 pin as close as possible to the (+) terminal of an input ceramic capacitor (suggest 10 μ F).
VIN3	13	Input power supply for Buck3. Connect VIN3 pin as close as possible to the (+) terminal of an input ceramic capacitor (suggest 10 μ F).
PGND3	14	Power ground connection of Buck3. Connect PGND3 pin as close as possible to the (–) terminal of VIN3 input ceramic capacitor.
LX3	15	Switching node connection to the inductor and bootstrap capacitor for Buck3. The voltage swing at this pin is from a diode voltage below the ground up to VIN3 voltage.

Pin Functions (continued)

PIN		DESCRIPTION
NAME	NO.	
BST3	16	Boot strapped supply to the high side floating gate driver in Buck3. Connect a capacitor (recommend 47 nF) from BST3 pin to LX3 pin.
EN3	17	Enable for Buck3. Float to enable. Can use this pin to adjust the input undervoltage lockout of Buck3 with a resistor divider.
FB3	18	Feedback Kelvin sensing pin for buck3 output voltage. Connect this pin to Buck3 resistor divider.
AGND	19	Analog ground common to buck controllers and other analog circuits. It must be routed separately from high current power grounds to the (-) terminal of bypass capacitor of input voltage VIN.
V7V	20	Internal LDO for gate driver and internal controller. Connect a 1- μ F capacitor from the pin to power ground
COMP1	21	Error amplifier output and loop compensation pin for Buck1. Connect a series resistor and capacitor to compensate the control loop of buck1 with peak current PWM mode.
SS1	22	Soft-start and tracking input for Buck1. An internal 5- μ A pullup current source is connected to this pin. The soft-start time can be programmed by connecting a capacitor between this pin and ground.
FB1	23	Feedback Kelvin sensing pin for Buck1 output voltage. Connect this pin to Buck1 resistor divider.
EN1	24	Enable for Buck1. Float to enable. Can use this pin to adjust the input undervoltage lockout of Buck1 with a resistor divider.
BST1	25	Boot strapped supply to the high side floating gate driver in buck1. Connect a capacitor (recommend 47 nF) from BST1 pin to LX1 pin.
LX1	26	Switching node connection to the inductor and bootstrap capacitor for buck1. The voltage swing at this pin is from a diode voltage below the ground up to VIN1 voltage.
PGND1	27	Power ground connection of buck1. Connect PGND1 pin as close as possible to the (-) terminal of VIN1 input ceramic capacitor.
VIN1	28	Input power supply for buck1. Connect VIN1 pin as close as possible to the (+) terminal of an input ceramic capacitor (suggest 10 μ F).
LEN1	29	Enable for LDO1. Float to enable.
LFB1	30	Feedback Kelvin sensing pin for LDO1 output voltage. Connect this pin to LDO1 resistor divider.
LOUT1	31	LDO1 output. Connect LOUT1 pin as close as possible to the (+) terminal of an output ceramic capacitor (suggest 1 μ F).
LVIN1	32	Input power supply for LDO1. Connect LVIN1 pin as close as possible to the (+) terminal of an input ceramic capacitor (suggest 1 μ F).
PAD	—	There is no electric signal down bonded to thermal pad inside IC. Exposed thermal pad must be soldered to PCB for optimal thermal performance.

6 Specifications

6.1 Absolute Maximum Ratings

over operating free-air temperature range (unless otherwise noted) (operating in a typical application circuit)⁽¹⁾

		MIN	MAX	UNIT
Voltage	VIN1, VIN2, VIN3, LVIN1, LVIN2	-0.3	20	V
	LX1, LX2, LX3 (Maximum withstand voltage transient <20 ns)	-1.0	20	
	BST1, BST2, BST3 referenced to LX1, LX2, LX3 pins respectively	-0.3	7	
	MODE, LEN1, LEN2, EN1, EN2, EN3, PGOOD, V7V	-0.3	7	
	LOUT1, LOUT2	-0.3	7	
	FB1, FB2, FB3, LFB1, LFB2, COMP1, SS1	-0.3	3.6	
	AGND, PGND1, PGND2, PGND3	-0.3	0.3	
T _J	Operating junction temperature	-40	125	°C
T _{stg}	Storage temperature	-55	150	°C

- (1) Stresses beyond those listed under *Absolute Maximum Ratings* may cause permanent damage to the device. These are stress ratings only and functional operation of the device at these or any other conditions beyond those indicated under *recommended operating conditions* is not implied. Exposure to absolute-maximum-rated conditions for extended periods may affect device reliability.

6.2 ESD Ratings

		VALUE	UNIT
V _(ESD)	Electrostatic discharge	Human body model (HBM), per ANSI/ESDA/JEDEC JS-001, all pins ⁽¹⁾	±2000
		Charged device model (CDM), per JEDEC specification JESD22-C101, all pins ⁽²⁾	±500

- (1) JEDEC document JEP155 states that 500-V HBM allows safe manufacturing with a standard ESD control process. *Pins listed as 1 kV may actually have higher performance.*
- (2) JEDEC document JEP157 states that 250-V CDM allows safe manufacturing with a standard ESD control process. *Pins listed as 250 V may actually have higher performance.*

6.3 Recommended Operating Conditions

over operating free-air temperature range (unless otherwise noted)

		MIN	MAX	UNIT
Voltage	VIN1, VIN2, VIN3, LVIN1, LVIN2	4.5	18	V
	LX1, LX2, LX3 (maximum withstand voltage transient <20 ns)	-0.8	18	
	BST1, BST2, BST3 referenced to LX1, LX2, LX3 pins respectively	-0.1	6.8	
	MODE, LEN1, LEN2, EN1, EN2, EN3, PGOOD, V7V	-0.1	6.3	
	FB1, FB2, FB3, LFB1, LFB2, COMP1, SS1	-0.1	3	
	LOUT1, LOUT2	-0.1	5.5	
T _J	Operating junction temperature	-40	125	°C

6.4 Thermal Information

THERMAL METRIC ⁽¹⁾		TPS65262-2	UNIT
		RHB (VQFN)	
		32 PINS	
R _{θJA}	Junction-to-ambient thermal resistance	32	°C/W
R _{θJC(top)}	Junction-to-case (top) thermal resistance	24.2	°C/W
R _{θJB}	Junction-to-board thermal resistance	6.4	°C/W
ψ _{JT}	Junction-to-top characterization parameter	0.2	°C/W
ψ _{JB}	Junction-to-board characterization parameter	6.4	°C/W
R _{θJC(bot)}	Junction-to-case (bottom) thermal resistance	1.3	°C/W

- (1) For more information about traditional and new thermal metrics, see the *Semiconductor and IC Package Thermal Metrics* application report, [SPRA953](#).

6.5 Electrical Characteristics

$T_J = -40^{\circ}\text{C}$ to 125°C , typical values are at $T_J = 25^{\circ}\text{C}$ (unless otherwise noted)

PARAMETER		TEST CONDITIONS	MIN	TYP	MAX	UNIT
INPUT SUPPLY VOLTAGE						
VIN	Input voltage range		4.5		18	V
UVLO	VIN undervoltage lockout	VIN rising	4	4.25	4.5	V
		VIN falling	3.5	3.75	4	
		Hysteresis		500		mV
IDDSDN	Shutdown supply current	EN1 = EN2 = EN3 = MODE = LEN1 = LEN2 = 0 V		12		μA
IDDQ_NSW	Input quiescent current without buck1/2/3 switching	EN1 = EN2 = EN3 = 5V, FB1 = FB2 = FB3 = 0.8 V, LEN1 = LEN2 = 0 V		790		μA
IDDQ_NSW1		EN1 = 5 V, EN2 = EN3 = 0 V, FB1 = 0.8 V, LEN1 = LEN2 = 0 V		340		μA
IDDQ_NSW2		EN2 = 5 V, EN1 = EN3 = 0V, FB2 = 0.8 V, LEN1 = LEN2 = 0 V		370		μA
IDDQ_NSW3		EN3 = 5 V, EN1 = EN2 = 0 V, FB3 = 0.8 V, LEN1 = LEN2 = 0 V		370		μA
IDDQ_LD01	LDO input quiescent current	EN1 = EN2 = EN3 = LEN2 = 0 V, LFB1 = 0.8 V, LEN1 = 5 V		190		μA
IDDQ_LD02		EN1 = EN2 = EN3 = LEN1 = 0 V, LFB2 = 0.8 V, LEN2 = 5 V		190		μA
V7V	V7V LDO output voltage	VIN1 = 12 V; V7V load current = 0 A	6.0	6.3	6.6	V
I _{OC} _V7V	V7V LDO current limit			175		mA
FEEDBACK VOLTAGE REFERENCE						
V _{FB}	Feedback voltage	V _{COMP} = 1.2 V, T _J = 25°C	0.595	0.6	0.605	V
		V _{COMP} = 1.2 V, T _J = -40°C to 125°C	0.594	0.6	0.606	V
V _{LINEREG} _Buck	Line regulation-DC ⁽¹⁾	I _{OUT1} = 1.5 A, I _{OUT2} = 1 A, I _{OUT3} = 1 A, 5 V < VINx < 18 V		0.002		%/V
V _{LOADREG} _Buck	Load regulation-DC ⁽¹⁾	V _{IN} = 12 V, I _{OUTx} = (10-100%) × I _{OUTx_max}		0.02		%/A
BUCK1, BUCK2, BUCK3						
V _{ENXH}	EN1/2/3 high level input voltage			1.2	1.27	V
V _{ENXL}	EN1/2/3 low level input voltage		1.0	1.15		V
I _{ENX}	EN1/2/3 pullup current	ENx = 1 V		3.6		μA
I _{ENX}	EN1/2/3 pullup current	ENx = 1.5 V		6.6		μA
I _{ENhys}	Hysteresis current			3		μA
I _{SS1}	Buck1 soft start charging current		4.3	5	6.1	μA
T _{SS2/3}	Buck2/3 soft start time			1		ms
T _{ON_MIN}	Minimum on time			80	100	ns
G _m _EA1/2/3	Error amplifier trans-conductance	-2 μA < I _{COMPX} < 2 μA		300		μS
G _m _PS1/2/3	COMP voltage to inductor current G _m ⁽¹⁾	I _{LX} = 0.5 A		7.4		A/V
I _{LIMIT1}	Buck1 peak inductor current limit		4.2	5.1	6	A
I _{LIMITSOURCE1}	Buck1 low-side source current limit			4.4		A
I _{LIMITS1}	Buck1 low-side sink current limit			1.3		A
I _{LIMIT2/3}	Buck2/3 peak inductor current limit		1.8	2.4	3	A
I _{LIMITSOURCE2/3}	Buck2/3 low-side source current limit			1.75		A
I _{LIMITS2/3}	Buck2/3 low-side sink current limit			1		A
t _{Hiccup_wait}	OC wait time ⁽¹⁾			0.5		ms
t _{Hiccup_re}	Hiccup time before restart ⁽¹⁾			14		ms
R _{dson_HS1}	Buck1 High-side switch resistance	VIN1 = 12 V		100		m Ω
R _{dson_LS1}	Buck1 low-side switch resistance	VIN1 = 12 V		65		m Ω
R _{dson_HS2}	Buck2 High-side switch resistance	VIN1 = 12 V		195		m Ω
R _{dson_LS2}	Buck2 low-side switch resistance	VIN1 = 12 V		145		m Ω
R _{dson_HS3}	Buck3 High-side switch resistance	VIN1 = 12 V		195		m Ω
R _{dson_LS3}	Buck3 low-side switch resistance	VIN1 = 12 V		145		m Ω

(1) Lab validation result.

Electrical Characteristics (continued)

 $T_J = -40^{\circ}\text{C}$ to 125°C , typical values are at $T_J = 25^{\circ}\text{C}$ (unless otherwise noted)

PARAMETER		TEST CONDITIONS	MIN	TYP	MAX	UNIT
POWER GOOD, MODE, POWER SEQUENCE						
V_{th_PG}	Feedback voltage threshold	FBx undervoltage falling		92.5%		V_{REF}
		FBx undervoltage rising		95%		
		FBx overvoltage rising		107.5%		
		FBx overvoltage falling		105%		
$t_{DEGLITCH(PG)_F}$	PGOOD falling edge deglitch time		0.19			ms
$t_{RDEGLITCH(PG)_R}$	PGOOD rising edge deglitch time		1			ms
I_{PG}	PGOOD pin leakage				0.05	μA
V_{LOW_PG}	PGOOD pin low voltage	$I_{SINK} = 1\text{ mA}$			0.4	V
V_{MODEH}	MODE high level input voltage			1.2	1.27	V
V_{MODEL}	MODE low level input voltage		1.0	1.15		V
I_{MODE}	MODE pullup current	MODE = 1 V		3.6		μA
I_{MODE}	MODE pullup current	MODE = 1.5 V		6.6		μA
LDO1 AND LDO2						
V_{LENXH}	LEN1, LEN2 high-level input voltage			1.2	1.27	V
V_{LENXL}	LEN1, LEN2 low-level input voltage		1.0	1.15		V
I_{LENX}	LEN1, LEN2 pullup current	LENx = 1 V		3.6		μA
		LENx = 1.5 V		6.6		
V_{IN_LDO1}	LDO input voltage range		1.3		18	V
V_{OUT_LDO1}	LDO output voltage range	load current = 350 mA, $V_{IN} = 12\text{ V}$	1		5.5	V
V_{LDOFB1}	LDO voltage reference	load current = 10 mA, $V_{IN} = 12\text{ V}$	0.593	0.6	0.607	V
I_{max_LDO1}	LDO current limit	$T_J = 25^{\circ}\text{C}$	350	440	559	mA
$V_{dropout1}$	LDO dropout voltage	$I_{OUT} = 20\text{ mA}$		12		mV
		$I_{OUT} = 200\text{ mA}$		120		mV
V_{LINREG_LDO1}	LDO line regulation-DC ⁽¹⁾	$V_{OUT} = 1.8\text{ V}$, $I_{OUT} = 10\text{ mA}$, LVIN1 changes from 2 to 18 V		0.002		%/V
$V_{LOADREG_LDO1}$	LDO load regulation-DC ⁽¹⁾	$I_{OUT} = 1\text{ mA}$ to 350 mA		0.2		%/A
$PSRR_{LDO1}$	Ripple rejection ⁽¹⁾	$V_{in_LDO1} = 12\text{ V}$, $V_{OUT} = 1.8\text{ V}$, $I_{OUT} = 10\text{ mA}$, $f = 10\text{ kHz}$		56		dB
V_{IN_LDO2}	LDO input voltage range		1.3		18	V
V_{OUT_LDO2}	LDO output voltage range	Load current = 150 mA, $V_{IN} = 12\text{ V}$	1		5.5	V
V_{LDOFB2}	LDO voltage reference	Load current = 10 mA, $V_{IN} = 12\text{ V}$	0.593	0.6	0.607	V
I_{max_LDO2}	LDO current limit	$T_J = 25^{\circ}\text{C}$	160	230	295	mA
$V_{dropout2}$	LDO drop out voltage	$I_{OUT} = 10\text{ mA}$		12		mV
		$I_{OUT} = 100\text{ mA}$		120		mV
V_{LINREG_LDO2}	LDO line regulation-DC ⁽¹⁾	$V_{OUT} = 1.8\text{ V}$, $I_{OUT} = 10\text{ mA}$, LVIN1 changes from 2 to 18 V		0.002		%/V
$V_{LOADREG_LDO2}$	LDO load regulation-DC ⁽¹⁾	$I_{OUT} = 1$ to 150 mA, $V_{IN} = 12\text{ V}$		0.2		%/A
$PSRR_{LDO2}$	Ripple rejection ⁽¹⁾	$V_{in_LDO2} = 12\text{ V}$, $V_{OUT} = 1.8\text{ V}$, $I_{OUT} = 10\text{ mA}$, $f = 10\text{ kHz}$		56		dB
OSCILLATOR						
f_{SW}	Switching frequency		540	600	670	kHz
THERMAL PROTECTION						
T_{TRIP_OTP}	Thermal protection trip point ⁽¹⁾	Temperature rising		160		$^{\circ}\text{C}$
T_{HYST_OTP}		Hysteresis		20		$^{\circ}\text{C}$

6.6 Typical Characteristics

$T_A = 25^\circ\text{C}$, $V_{IN} = 12\text{ V}$, $V_{OUT1} = 1.2\text{ V}$, $V_{OUT2} = 1.8\text{ V}$, $V_{OUT3} = 3.3\text{ V}$, $f_{SW} = 600\text{ kHz}$ (unless otherwise noted)

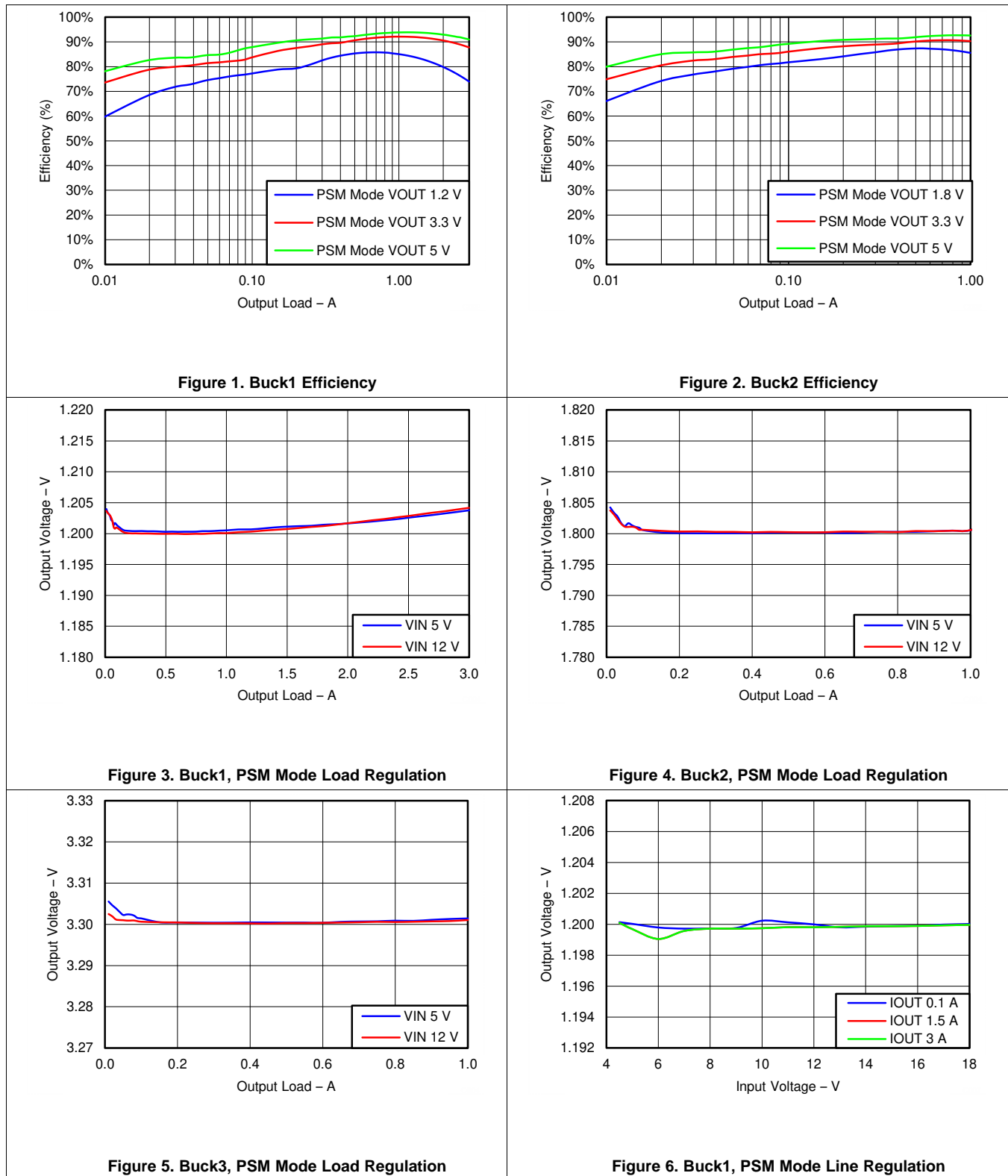

Typical Characteristics (continued)

$T_A = 25^\circ\text{C}$, $V_{IN} = 12\text{ V}$, $V_{OUT1} = 1.2\text{ V}$, $V_{OUT2} = 1.8\text{ V}$, $V_{OUT3} = 3.3\text{ V}$, $f_{SW} = 600\text{ kHz}$ (unless otherwise noted)

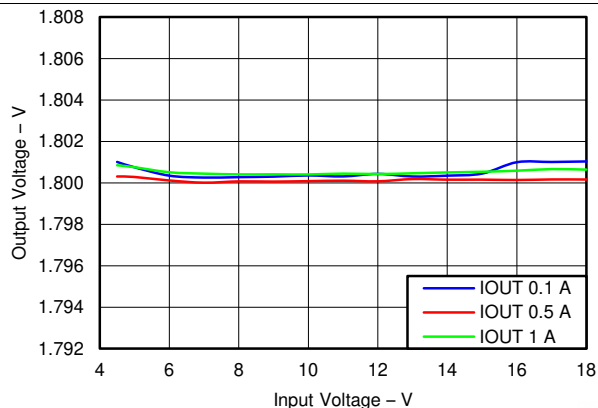

Figure 7. Buck2, PSM Mode Line Regulation

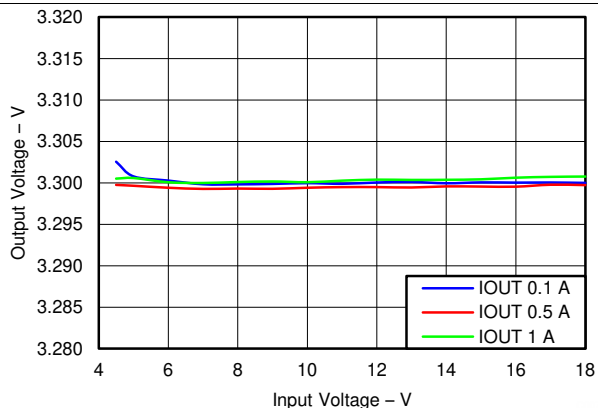

Figure 8. Buck3, PSM Mode Line Regulation

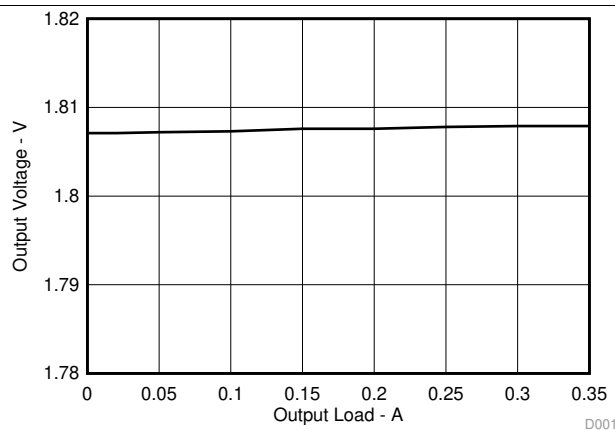

Figure 9. LDO1, Load Regulation, $V_{IN} = 3.3\text{ V}$

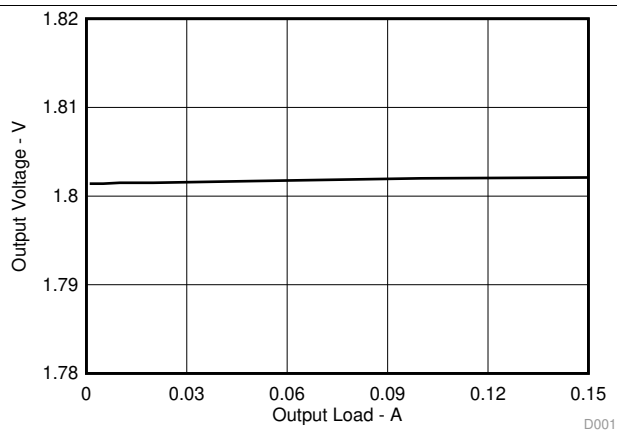

Figure 10. LDO2, Load Regulation, $V_{IN} = 3.3\text{ V}$

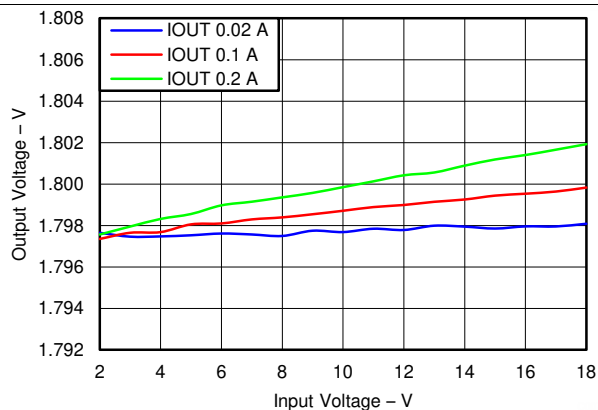

Figure 11. LDO1, Line Regulation

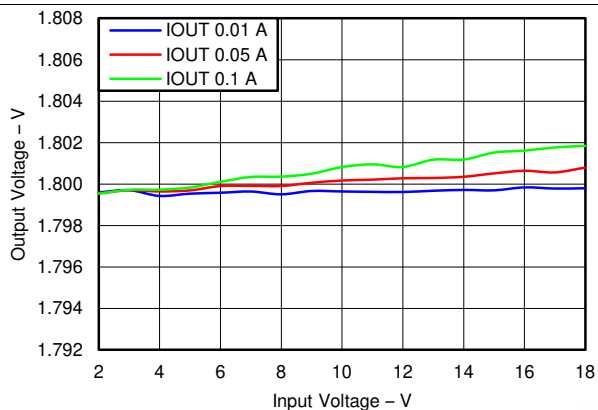

Figure 12. LDO2, Line Regulation

Typical Characteristics (continued)

$T_A = 25^\circ\text{C}$, $V_{IN} = 12\text{ V}$, $V_{OUT1} = 1.2\text{ V}$, $V_{OUT2} = 1.8\text{ V}$, $V_{OUT3} = 3.3\text{ V}$, $f_{SW} = 600\text{ kHz}$ (unless otherwise noted)

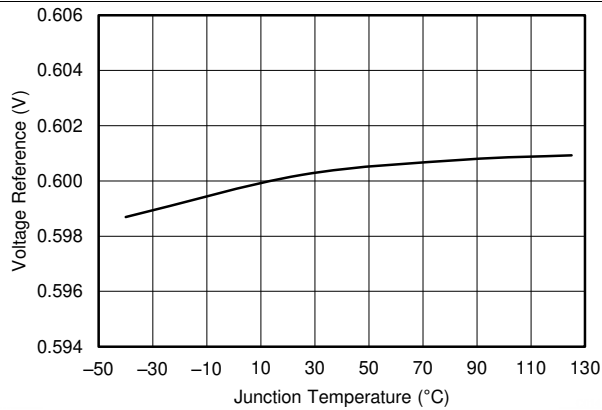

Figure 13. Voltage Reference vs Temperature

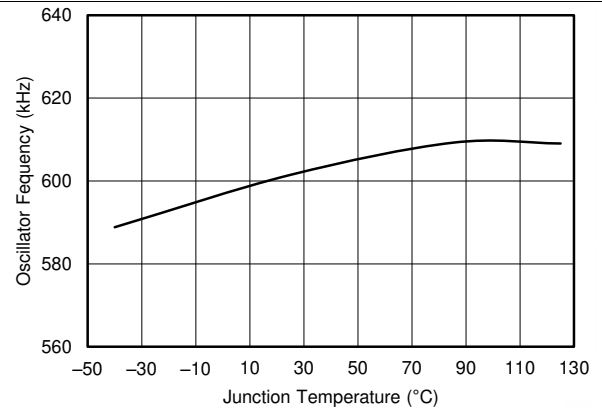

Figure 14. Oscillator Frequency vs Temperature

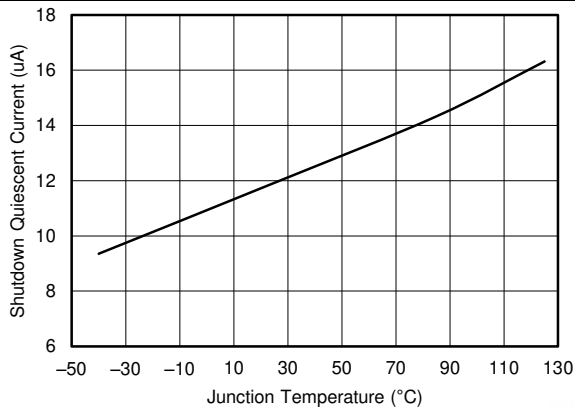

Figure 15. Shutdown Quiescent Current vs Temperature

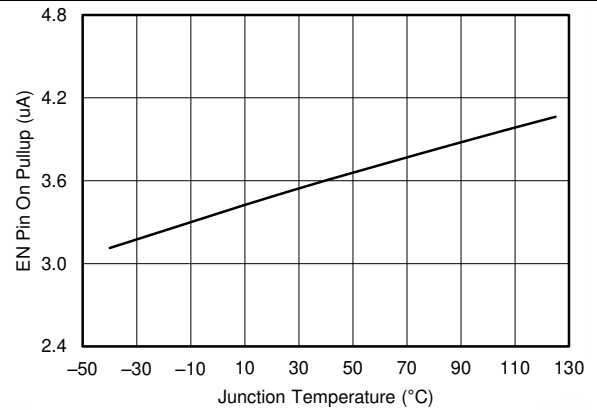

Figure 16. EN Pin Pullup Current vs Temperature, EN = 1 V

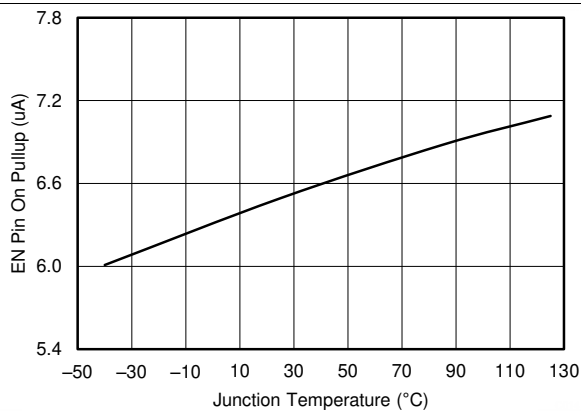

Figure 17. EN Pin Pullup Current vs Temperature, EN = 1.5 V

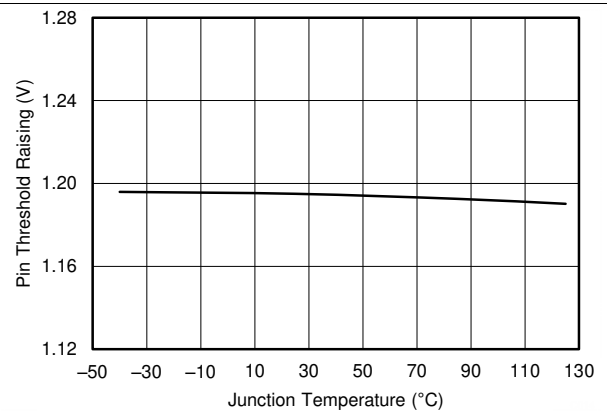

Figure 18. EN Pin Threshold Rising vs Temperature

Typical Characteristics (continued)

$T_A = 25^\circ\text{C}$, $V_{IN} = 12\text{ V}$, $V_{OUT1} = 1.2\text{ V}$, $V_{OUT2} = 1.8\text{ V}$, $V_{OUT3} = 3.3\text{ V}$, $f_{SW} = 600\text{ kHz}$ (unless otherwise noted)

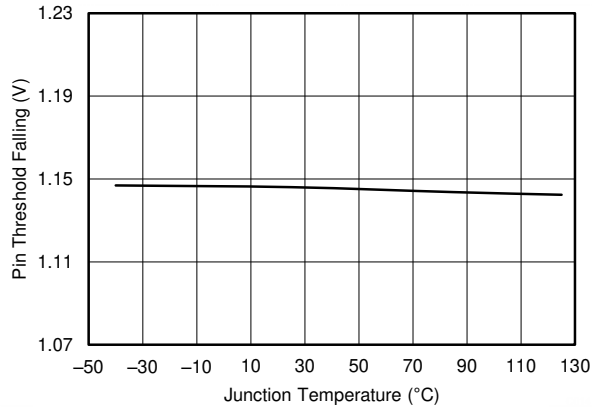

Figure 19. EN Pin Threshold Falling vs Temperature

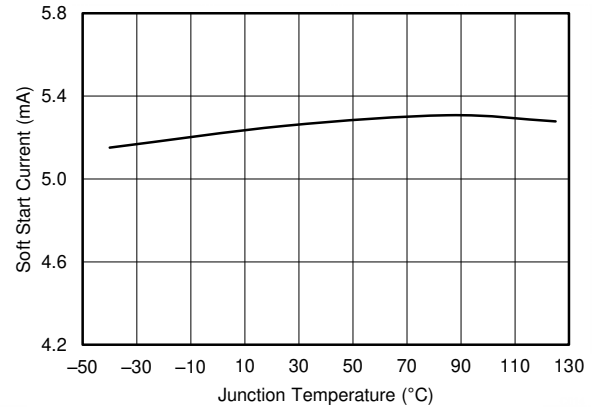

Figure 20. SS Pin Charge Current vs Temperature

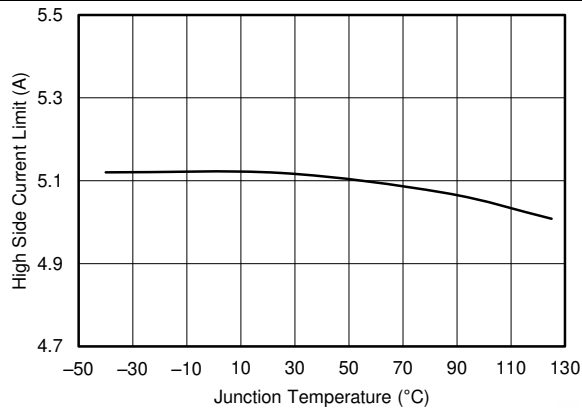

Figure 21. Buck1 High-Side Current Limit vs Temperature

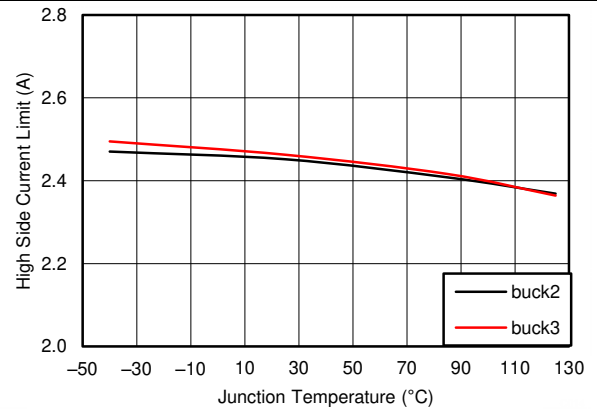

Figure 22. Buck2, 3 High-Side Current Limit vs Temperature

7 Detailed Description

7.1 Overview

The TPS65262-2 is a monolithic triple synchronous step-down (buck) converter with 3-A/1-A/1-A output currents. A wide 4.5- to 18-V input supply voltage range encompasses most intermediate bus voltages operating off 5-, 9-, 12-, or 15-V power bus. The feedback voltage reference for each buck is 0.6V. Each buck is independent with dedicated enable, soft-start and loop compensation.

The TPS65262-2 implements a constant frequency, peak current mode control that simplifies external loop compensation. The switching frequency is fixed 600 kHz. The switching clock of buck1 is 180° out-of-phase operation from the clocks of buck2 and buck3 channels to reduce input current ripple, input capacitor size and power supply induced noise.

The TPS65262-2 has been designed for safe monotonic startup into pre-biased loads. The default start up is when VIN is typically 4.5 V. The ENx pin also can be used to adjust the input voltage undervoltage lockout (UVLO) with an external resistor divider. In addition, the ENx pin has an internal 3.6- μ A current source, so the EN pin can be floating for automatically powering up the converters.

The TPS65262-2 reduces the external component count by integrating the bootstrap circuit. The bias voltage for the integrated high-side MOSFET is supplied by a capacitor between the BST and LX pins. A UVLO circuit monitors the bootstrap capacitor voltage VBST-VLX in each buck. When VBST-VLX voltage drops to the threshold, LX pin is pulled low to recharge the bootstrap capacitor. The TPS65262-2 can operate at 100% duty cycle as long as the bootstrap capacitor voltage is higher than the BOOT-LX UVLO threshold which is typically 2.1 V.

The TPS65262-2 features a PGOOD pin to supervise each output voltage of buck converters. The TPS65262-2 has power good comparators with hysteresis, which monitor the output voltages through feedback voltages. When all bucks are in regulation range and power sequence is done, PGOOD is asserted to high.

The SS (soft start/tracking) pin is used to minimize inrush currents during power up. A small value capacitor or resistor divider is coupled to the pin for soft start or voltage tracking.

The TPS65262-2 operates in pulse skipping mode (PSM) with connecting MODE pin to GND and operates in forced continuous current (FCC) mode with driving MODE pin to high or leaving float.

The TPS65262-2 integrates low drop-out voltage linear regulators (LDO) with input voltage from 1.3 to 18 V, independent enable and adjustable outputs, up to 350 mA for LDO1 and 150 mA for LDO2 continuous output current.

The TPS65262-2 is protected from overload and over temperature fault conditions. The converter minimizes excessive output overvoltage transients by taking advantage of the power good comparator. When the output is over, the high-side MOSFET is turned off until the internal feedback voltage is lower than 105% of the 0.6-V reference voltage. The TPS65262-2 implements both high-side MOSFET overload protection and bidirectional low-side MOSFET overload protections to avoid inductor current runaway. If the over current condition has lasted for more than the OC wait time (0.5 ms), the converter will shut down and restart after the hiccup time (14 ms). The TPS65262-2 shuts down if the junction temperature is higher than thermal shutdown trip point 160°C. When the junction temperature drops 20°C (typical) below the thermal shutdown trip point, the TPS65262-2 will be restarted under control of the soft-start circuit automatically.

The TPS65262-2 is available in a 32-lead thermally-enhanced VQFN (RHB) package.

7.2 Functional Block Diagram

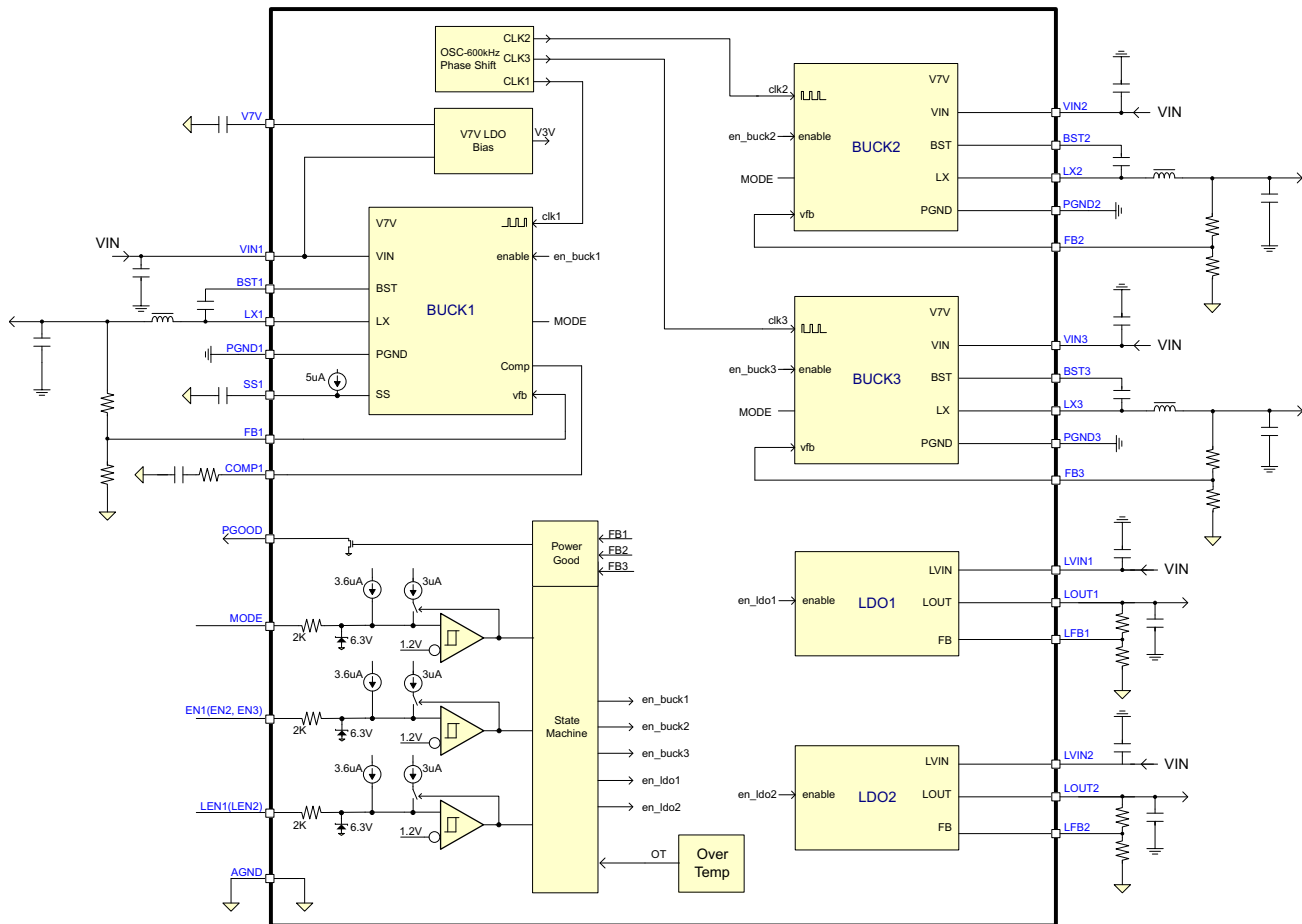

7.3 Feature Description

7.3.1 Adjusting the Output Voltage

The output voltage of each buck is set with a resistor divider from the output of buck to the FB pin. TI recommends to use 1% tolerance or better divider resistors.

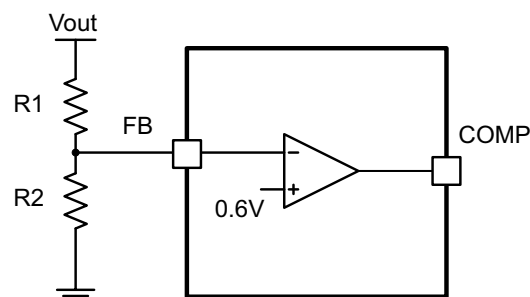

Figure 23. Voltage Divider Circuit

$$R_2 = R_1 \times \frac{0.6}{V_{out} - 0.6} \quad (1)$$

To improve efficiency at light loads consider using larger value resistors. If the values are too high, the regulator is more sensitive to noise. The recommended resistor values are shown in Table 1.

Table 1. Output Resistor Divider Selection

OUTPUT VOLTAGE (V)	R1 (kΩ)	R2 (kΩ)
1	10	15
1.2	10	10
1.5	15	10
1.8	20	10
2.5	31.6	10
3.3	45.3	10
3.3	22.6	4.99
5	73.2	10
5	36.5	4.99

7.3.2 Enable and Adjusting Undervoltage Lockout

The EN1/2/3 pin provides electrical on/off control of the device. After the EN1/2/3 pin voltage exceeds the threshold voltage, the device starts operation. If each ENx pin voltage is pulled below the threshold voltage, the regulator stops switching and enters low Iq state.

The EN pin has an internal pullup current source, allowing the user to float the EN pin for enabling the device. If an application requires controlling the EN pin, use open drain or open collector output logic to interface with the pin.

The device implements internal UVLO circuitry on the VIN pin. The device is disabled when the VIN pin voltage falls below the internal VIN UVLO threshold. The internal VIN UVLO threshold has a hysteresis of 500mV. If an application requires a higher UVLO threshold on the VIN pin, then the ENx pin can be configured as shown in [Figure 24](#). When using the external UVLO function it is recommended to set the hysteresis to be greater than 500mV.

The EN pin has a small pullup current I_p which sets the default state of the pin to enable when no external components are connected. The pullup current is also used to control the voltage hysteresis for the UVLO function since it increases by I_h once the EN pin crosses the enable threshold. The UVLO thresholds can be calculated using [Equation 2](#) and [Equation 3](#).

$$R_1 = \frac{V_{START} \left(\frac{V_{ENFALLING}}{V_{ENRISING}} \right) - V_{STOP}}{I_p \left(1 - \frac{V_{ENFALLING}}{V_{ENRISING}} \right) + I_h} \quad (2)$$

$$R_2 = \frac{R_1 \times V_{ENFALLING}}{V_{STOP} - V_{ENFALLING} + R_1 (I_h + I_p)}$$

where

- $I_h = 3 \mu A$
- $I_p = 3.6 \mu A$
- $V_{ENRISING} = 1.2 V$
- $V_{ENFALLING} = 1.15 V$

(3)

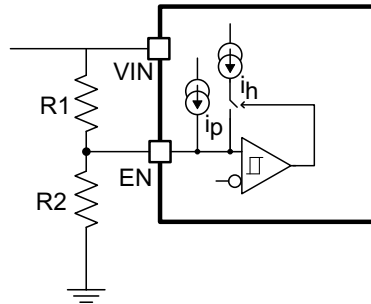

Figure 24. Adjustable VIN Undervoltage Lockout

7.3.3 Soft-Start Time

The voltage on the SS1 pin controls the start-up of buck1 output. When the voltage on the SS1 pin is less than the internal 0.6-V reference, The TPS65262-2 regulates the internal feedback voltage to the voltage on the SS1 pin instead of 0.6 V, allowing VOUT to rise smoothly from 0 V to its regulated voltage without inrush current. The device has an internal pullup current source of 5 μ A (typical) that charges an external soft-start capacitor to provide a linear ramping voltage at SS1 pin.

Buck1's soft-start time can be calculated approximately by [Equation 4](#).

Buck2 and Buck3 have fixed 1-ms soft start time.

$$T_{ss}(\text{ms}) = C_{ss}(\text{nF}) \times \left(\frac{0.6\text{V}}{5\mu\text{A}} \right) \quad (4)$$

7.3.4 Power-Up Sequencing

The TPS65262-2 has dedicated enable pin for each converter. The converter enable pins are biased by a current source that allows for easy sequencing by the addition of an external capacitor. Disabling the converter with an active pull-down transistor on the ENx pin allows for a predictable power-down timing operation. [Figure 25](#) shows the timing diagram of a typical buck power-up sequence with connecting a capacitor at ENx pin.

A typical 1.4- μ A current is charging ENx pin from input supply. When ENx pin voltage rise to typical 0.4 V, the internal V7V LDO turns on. A 3.6- μ A pullup current is sourcing ENx. After ENx pin voltage reaches to 1.2 V typical, 3- μ A hysteresis current sources to the pin to improve noise sensitivity. If all output voltages are in the regulation, PGOOD is asserted after PGOOD deglitch time.

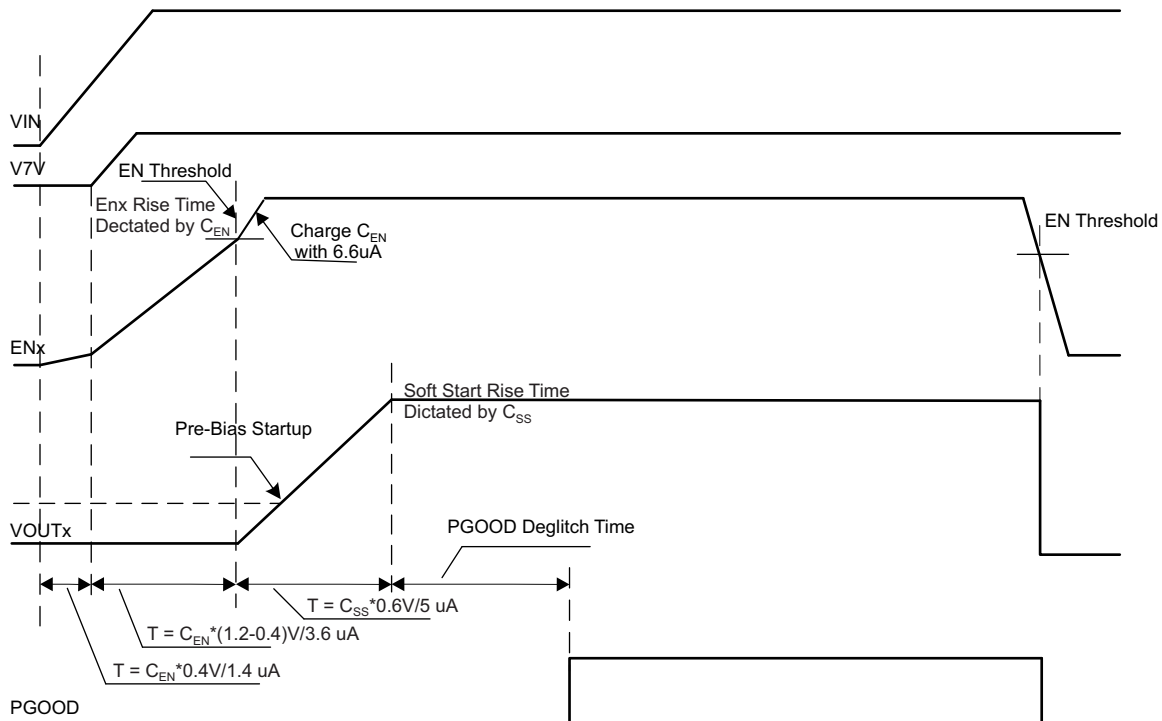
Figure 25. Startup Power Sequence

7.3.5 V7V Low Dropout Regulator and Bootstrap

Power for the high-side and low-side MOSFET drivers and most other internal circuitry is derived from the V7V pin. The internal built-in low dropout linear regulator (LDO) supplies 6.3 V (typical) from VIN to V7V. A 1- μ F ceramic capacitor should be connected from V7V pin to power ground.

If the input voltage, VIN decreases to UVLO threshold voltage, the UVLO comparator detects V7V pin voltage and forces the converter off.

Each high-side MOSFET driver is biased from the floating bootstrap capacitor, CB, shown in [Figure 26](#), which is normally recharged during each cycle through an internal low-side MOSFET or the body diode of low-side MOSFET when the high-side MOSFET turns off. The boot capacitor is charged when the BST pin voltage is less than VIN and BST-LX voltage is below regulation. The recommended value of this ceramic capacitor is 47 nF. A ceramic capacitor with an X7R or X5R grade dielectric with a voltage rating of 10 V or higher is recommended because of the stable characteristics over temperature and voltage. Each low-side MOSFET driver is powered from V7V pin directly.

To improve drop out, the device is designed to operate at 100% duty cycle as long as the BST to LX pin voltage is greater than the BST-LX UVLO threshold, which is typically 2.1 V. When the voltage between BST and LX drops below the BST-LX UVLO threshold, the high-side MOSFET is turned off and the low-side MOSFET is turned on allowing the boot capacitor to be recharged.

When a controller operates in PSM, the inductor current is not allowed to reverse. The reverse current comparator turns off the low-side MOSFET when the inductor current reaches zero, preventing it from reversing and going negative.

Due to the delay in the circuit and current comparator $tdly$ (typical 50 ns at $V_{in} = 12$ V), the real peak inductor current threshold to turn off high-side power MOSFET could shift higher depending on inductor inductance and input/output voltages. The threshold of peak inductor current to turn off high-side power MOSFET can be calculated by Equation 5.

$$I_{L_PEAK} = 230\text{mA} + \frac{v_{in} - v_{out}}{L} \times tdly \quad (5)$$

Once the charge accumulated on V_{out} capacitor is more than loading need, COMP pin voltage drops to low voltage driven by error amplifier. There is an internal comparator at COMP pin. If comp voltage is lower than 0.35 V, power stage stops switching to save power.

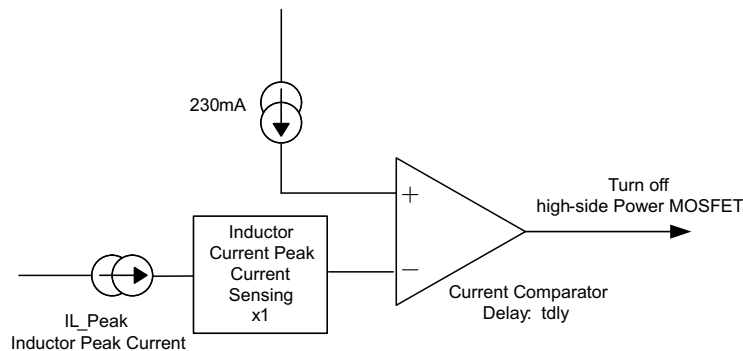

Figure 27. PSM Current Comparator

7.3.9 Slope Compensation

In order to prevent the sub-harmonic oscillations when the device operates at duty cycles greater than 50%, the device adds built-in slope compensation, which is a compensating ramp to the switch current signal.

7.3.10 Overcurrent Protection

The device is protected from over current conditions by cycle-by-cycle current limiting on both the high-side MOSFET and the low-side MOSFET.

7.3.10.1 High-Side MOSFET Overcurrent Protection

The device implements current mode control which uses the COMP pin voltage to control the turn off of the high-side MOSFET and the turn on of the low-side MOSFET on a cycle by cycle basis. Each cycle the switch current and the current reference generated by the COMP pin voltage are compared. When the peak switch current intersects the current reference, the high-side switch is turned off.

7.3.10.2 Low-Side MOSFET Overcurrent Protection

While the low-side MOSFET is turned on, its conduction current is monitored by the internal circuitry. During normal operation the low-side MOSFET sources current to the load. At the end of every clock cycle, the low-side MOSFET sourcing current is compared to the internally set low-side sourcing current limit. If the low-side sourcing current is exceeded, the high-side MOSFET is not turned on and the low-side MOSFET stays on for the next cycle. The high-side MOSFET is turned on again when the low-side current is below the low-side sourcing current limit at the start of a cycle.

The low-side MOSFET may also sink current from the load. If the low-side sinking current limit is exceeded, the low-side MOSFET is turned off immediately for the rest of that clock cycle. In this scenario both MOSFETs are off until the start of the next cycle.

Furthermore, if an output overload condition (as measured by the COMP pin voltage) has lasted for more than the hiccup wait time which is programmed for 0.5 ms shown in Figure 28, the device will shut down itself and restart after the hiccup time 14ms. The hiccup mode helps to reduce the device power dissipation under severe overcurrent condition.

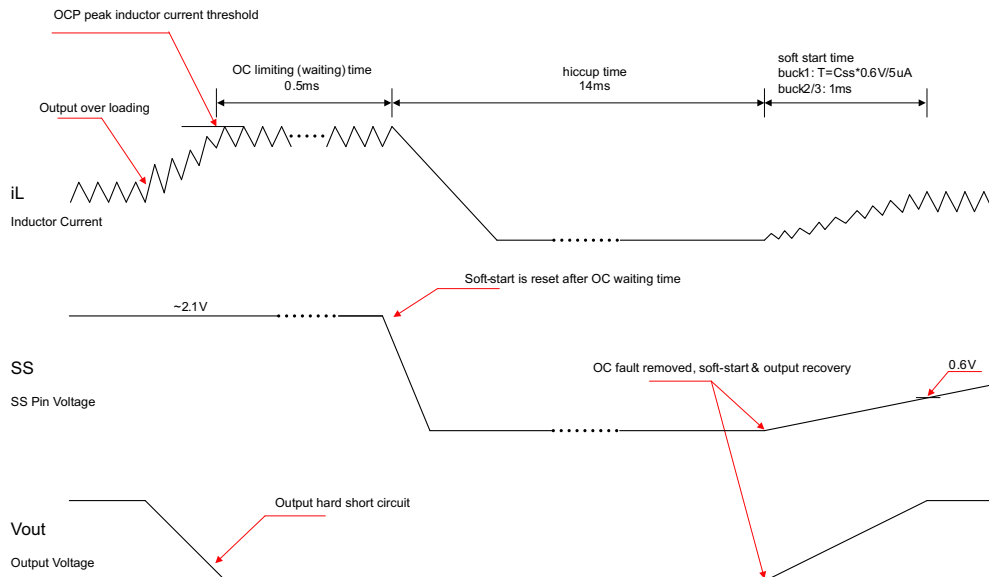

Figure 28. Overcurrent Protection

7.3.11 Power Good

The PGOOD pin is an open drain output. Once feedback voltage of each buck is between 95% (rising) and 105% (falling) of the internal voltage reference, the PGOOD pin pull-down is de-asserted and the pin floats. It is recommended to use a pullup resistor between the values of 10 and 100 kΩ to a voltage source that is 5.5 V or less. The PGOOD is in a defined state once the VIN input voltage is greater than 1 V, but with reduced current sinking capability. The PGOOD achieves full current sinking capability once the VIN input voltage is above UVLO threshold, which is 4.25 V.

The PGOOD pin is pulled low when any feedback voltage of buck is lower than 92.5% (falling) or greater than 107.5% (rising) of the nominal internal reference voltage. Also, the PGOOD is pulled low, if the input voltage is under-voltage locked up, thermal shutdown is asserted, the EN pin is pulled low or the converter is in a soft-start period.

7.3.12 Thermal Shutdown

The internal thermal shutdown circuitry forces the device to stop switching if the junction temperature exceeds 160°C typically. The device reinitiates the power up sequence when the junction temperature drops below 140°C typically.

Table 2. Related Parts

PART NUMBER	DESCRIPTION	COMMENTS
TPS65261	4.5- to 18-V, triple buck with input voltage power failure indicator	Triple buck 3-A/2-A/2-A output current, features an open drain RESET signal to monitor power down, automatic power sequencing
TPS65263	4.5- to 18-V, triple buck with I ² C interface	Triple buck 3-A/2-A/2-A output current, I2C controlled dynamic voltage scaling (DVS)
TPS65287	4.5- to 18-V, triple buck with power switch and push button control	Triple buck 3-A/2-A/2-A output current, up to 2.1-A USB power with over current setting by external resistor, push button control for intelligent system power-on/power-off operation
TPS65288	4.5- to 18-V, triple buck with dual power switches	Triple buck 3-A/2-A/2-A output current, 2 USB power switches current limiting at typical 1.2 A (0.8/1.0/1.4/1.6/1.8/2.0/2.2 A available with manufacture trim options)

7.4 Device Functional Modes

7.4.1 Operation With $V_{IN} < 4.5$ V (Minimum V_{IN})

The device operates with input voltages above 4.5 V. The maximum UVLO voltage is 4.5 V and operates at input voltages above 4.5 V. The typical UVLO voltage is 4.25 V, and the device may operate at input voltages above that point. The device also may operate at lower input voltages; the minimum UVLO voltage is 4 V (rising) and 3.5 V (falling). At input voltages below the UVLO minimum voltage, the device does not operate.

7.4.2 Operation With EN Control

The enable rising edge threshold voltage is 1.2 V typical and 1.26 V maximum. With EN held below that voltage, the device is disabled and switching is inhibited. The IC quiescent current is reduced in this state. When the input voltage is above the UVLO threshold and the EN voltage is increased above the rising edge threshold, the device becomes active. Switching is enabled, and the soft-start sequence is initiated. The device starts at the soft-start time determined by the external soft start capacitor as shown in [Figure 31](#) to [Figure 36](#).

8 Application and Implementation

NOTE

Information in the following applications sections is not part of the TI component specification, and TI does not warrant its accuracy or completeness. TI's customers are responsible for determining suitability of components for their purposes. Customers should validate and test their design implementation to confirm system functionality.

8.1 Application Information

The device is triple-synchronous, step-down DC/DC converter with dual LDOs. The device is typically used to convert a higher DC voltage to lower DC voltages with continuous available output current of 3 A/1 A/1 A. The following design procedure can be used to select component values for the TPS65262-2. This section presents a simplified discussion of the design process.

8.2 Typical Application

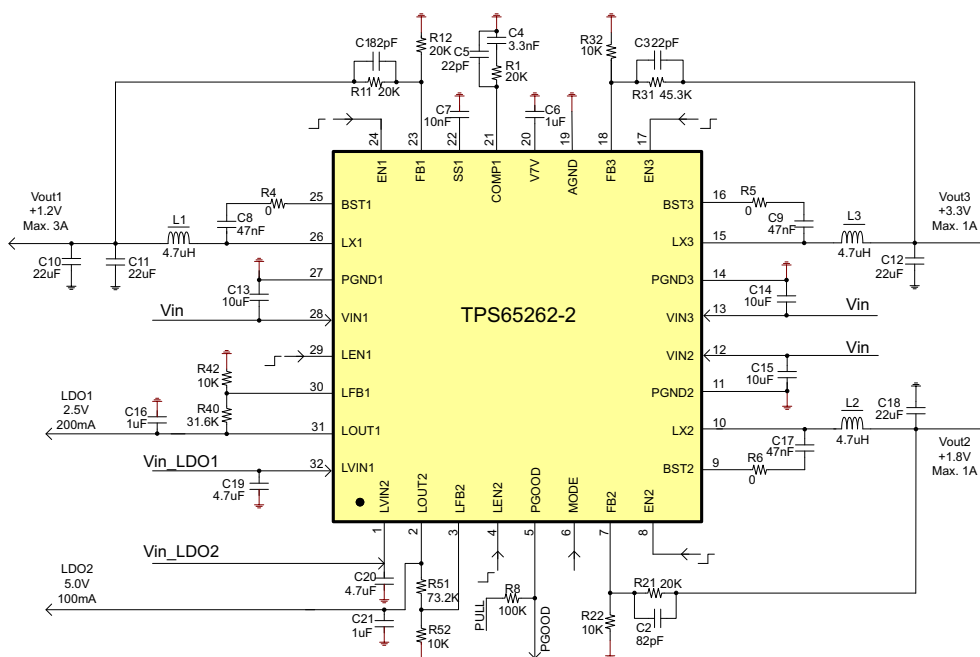

Figure 29. Typical Application Schematic

8.2.1 Design Requirements

This example details the design of a triple-synchronous step-down converter. A few parameters must be known to start the design process. These parameters are typically determined at the system level. For this example, start with the following known parameters shown in Table 3.

Table 3. Design Parameters

PARAMETER	VALUE
Vout1	1.2 V
Iout1	3 A
Vout2	1.8 V
Iout2	1 A
Vout3	3.3 V
Iout3	1 A
Buck1 transient response 1-A load step	±5%
Buck2, buck3 transient response 0.5-A load step	±5%
Input voltage	12 V normal, 4.5 to 18 V
Output voltage ripple	±1%
Switching frequency	600 kHz

8.2.2 Detailed Design Procedure

8.2.2.1 Output Inductor Selection

To calculate the value of the output inductor, use [Equation 6](#). LIR is a coefficient that represents the amount of inductor ripple current relative to the maximum output current. The inductor ripple current is filtered by the output capacitor. Therefore, choosing high inductor ripple currents impact the selection of the output capacitor since the output capacitor must have a ripple current rating equal to or greater than the inductor ripple current. In general, the inductor ripple value is at the discretion of the designer; however, LIR is normally from 0.1 to 0.3 for the majority of applications.

$$L = \frac{V_{inmax} - V_{out}}{I_o \times LIR} \times \frac{V_{out}}{V_{inmax} \times f_{sw}} \quad (6)$$

For the output filter inductor, it is important that the RMS current and saturation current ratings not be exceeded. The RMS and peak inductor current can be found from [Equation 8](#) and [Equation 9](#).

$$I_{ripple} = \frac{V_{inmax} - V_{out}}{L} \times \frac{V_{out}}{V_{inmax} \times f_{sw}} \quad (7)$$

$$I_{Lrms} = \sqrt{I_O^2 + \frac{\left(\frac{V_{out} \times (V_{inmax} - V_{out})}{V_{inmax} \times L \times f_{sw}} \right)^2}{12}} \quad (8)$$

$$I_{Lpeak} = I_{out} + \frac{I_{ripple}}{2} \quad (9)$$

The current flowing through the inductor is the inductor ripple current plus the output current. During power up, faults or transient load conditions, the inductor current can increase above the calculated peak inductor current level calculated above. In transient conditions, the inductor current can increase up to the switch current limit of the device. For this reason, the most conservative approach is to specify an inductor with a saturation current rating equal to or greater than the switch current limit rather than the peak inductor current.

8.2.2.2 Output Capacitor Selection

There are three primary considerations for selecting the value of the output capacitor. The output capacitor determines the modulator pole, the output voltage ripple, and how the regulator responds to a large change in load current. The output capacitance needs to be selected based on the most stringent of these three criteria.

The desired response to a large change in the load current is the first criteria. The output capacitor needs to supply the load with current when the regulator cannot. This situation would occur if there are desired hold-up times for the regulator where the output capacitor must hold the output voltage above a certain level for a specified amount of time after the input power is removed. The regulator is also temporarily not able to supply sufficient output current if there is a large, fast increase in the current needs of the load such as a transition from no load to full load. The regulator usually needs two or more clock cycles for the control loop to see the change in load current and output voltage and adjust the duty cycle to react to the change. The output capacitor must be sized to supply the extra current to the load until the control loop responds to the load change. The output capacitance must be large enough to supply the difference in current for 2 clock cycles while only allowing a tolerable amount of droop in the output voltage. Equation 10 shows the minimum output capacitance necessary to accomplish this.

$$C_o = \frac{2 \times \Delta I_{out}}{f_{sw} \times \Delta V_{out}}$$

where

- ΔI_{out} is the change in output current.
 - f_{sw} is the regulator's switching frequency.
 - ΔV_{out} is the allowable change in the output voltage.
- (10)

Equation 11 calculates the minimum output capacitance needed to meet the output voltage ripple specification.

$$C_o > \frac{1}{8 \times f_{sw}} \times \frac{1}{\frac{V_{oripple}}{I_{oripple}}}$$

where

- f_{sw} is the switching frequency
 - $V_{oripple}$ is the maximum allowable output voltage ripple
 - $I_{oripple}$ is the inductor ripple current
- (11)

Equation 12 calculates the maximum ESR an output capacitor can have to meet the output voltage ripple specification.

$$R_{esr} < \frac{V_{oripple}}{I_{oripple}}$$
(12)

Additional capacitance de-ratings for aging, temperature and DC bias should be factored in which increases this minimum value. Capacitors generally have limits to the amount of ripple current they can handle without failing or producing excess heat. An output capacitor that can support the inductor ripple current must be specified. Some capacitor data sheets specify the root mean square (RMS) value of the maximum ripple current. Equation 13 can be used to calculate the RMS ripple current the output capacitor needs to support.

$$I_{corms} = \frac{V_{out} \times (V_{inmax} - V_{out})}{\sqrt{12} \times V_{inmax} \times L \times f_{sw}}$$
(13)

8.2.2.3 Input Capacitor Selection

The TPS65262-2 requires a high quality ceramic, type X5R or X7R, input decoupling capacitor of at least 10 μ F of effective capacitance on the VIN input voltage pins. In some applications additional bulk capacitance may also be required for the VIN input. The effective capacitance includes any DC bias effects. The voltage rating of the input capacitor must be greater than the maximum input voltage. The capacitor must also have a ripple current rating greater than the maximum input current ripple of The TPS65262-2. The input ripple current can be calculated using Equation 14.

$$I_{inrms} = I_{out} \times \sqrt{\frac{V_{out}}{V_{inmin}} \times \frac{(V_{inmin} - V_{out})}{V_{inmin}}}$$
(14)

The value of a ceramic capacitor varies significantly over temperature and the amount of DC bias applied to the capacitor. The capacitance variations due to temperature can be minimized by selecting a dielectric material that is stable over temperature. X5R and X7R ceramic dielectrics are usually selected for power regulator capacitors because they have a high capacitance to volume ratio and are fairly stable over temperature. The output capacitor must also be selected with the DC bias taken into account. The capacitance value of a capacitor decreases as the DC bias across a capacitor increases. The input capacitance value determines the input ripple voltage of the regulator. The input voltage ripple can be calculated using [Equation 15](#).

$$\Delta V_{in} = \frac{I_{outmax} \times 0.25}{C_{in} \times f_{sw}} \quad (15)$$

8.2.2.4 Loop Compensation

The TPS65262-2 incorporates a peak current mode control scheme. The error amplifier is a transconductance amplifier with a gain of 300 μ S. A typical type II compensation circuit adequately delivers a phase margin between 60° to 90°. C_b adds a high-frequency pole to attenuate high frequency noise when needed. To calculate the external compensation components, follow the following steps.

1. Switching frequency f_{sw} 600 kHz is appropriate for application depending on L and C sizes, output ripple, EMI, and so forth, also gives best trade-off between performance and cost.
2. Set up crossover frequency, f_c , which is typically between 1/5 and 1/20 of f_{sw} .
3. R_C can be determined by

$$R_C = \frac{2\pi \times f_c \times V_o \times C_o}{G_{m-EA} \times V_{ref} \times G_{m-PS}} \quad (16)$$

Where G_{m-EA} is the error amplifier gain (300 μ S), G_{m-PS} is the power stage voltage to current conversion gain (7.4 A/V).

4. Calculate C_C by placing a compensation zero at or before the dominant pole $\left(f_p = \frac{1}{C_o \times R_L \times 2\pi} \right)$.

$$C_C = \frac{R_L \times C_o}{R_C} \quad (17)$$

5. Optional C_b can be used to cancel the zero from the ESR associated with C_o .

$$C_b = \frac{R_{ESR} \times C_o}{R_C} \quad (18)$$

6. Type III compensation can be implemented with the addition of one capacitor, C1. This allows for slightly higher loop bandwidths and higher phase margins. If used, C1 is calculated from [Equation 19](#).

$$C1 = \frac{1}{2\pi \times R1 \times f_c} \quad (19)$$

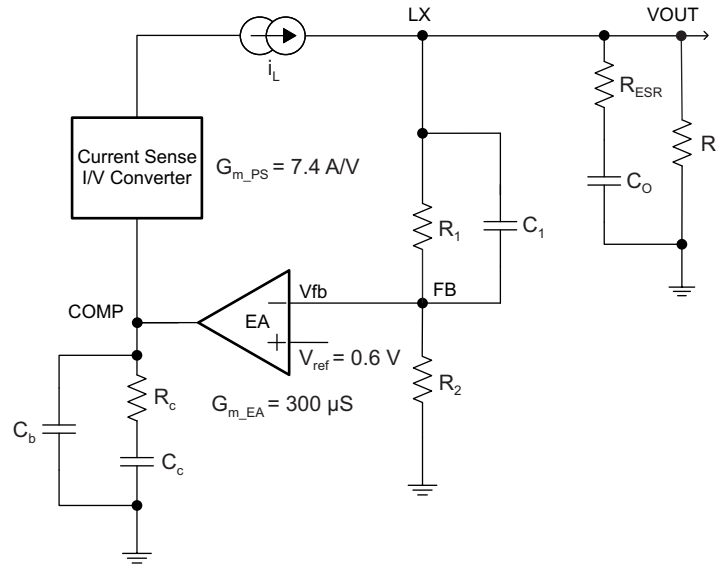

Figure 30. DC/DC Loop Compensation

8.2.3 Application Curves

$T_A = 25^\circ\text{C}$, $V_{IN} = 12\text{ V}$, $V_{OUT1} = 1.2\text{ V}$, $V_{OUT2} = 1.8\text{ V}$, $V_{OUT3} = 3.3\text{ V}$, $f_{SW} = 600\text{ kHz}$, PSM mode (unless otherwise noted)

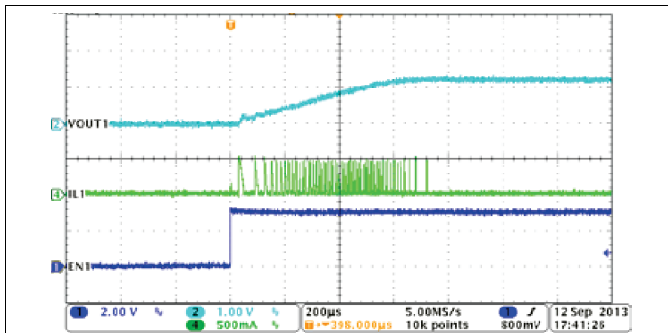

Figure 31. PSM Mode Buck1, Soft-Start With No Load

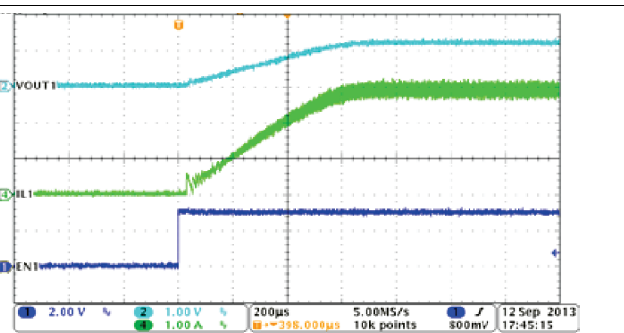

Figure 32. PSM Mode Buck1, Soft-Start With Full Load

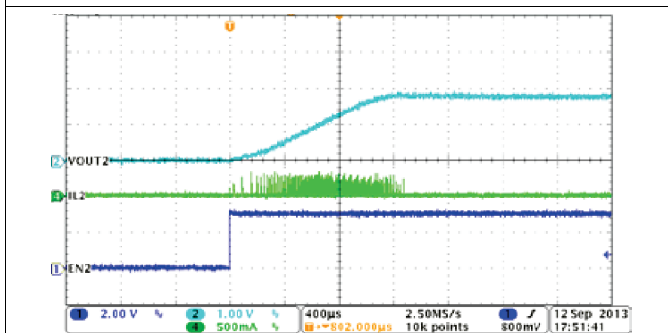

Figure 33. PSM Mode Buck2, Soft-Start With No Load

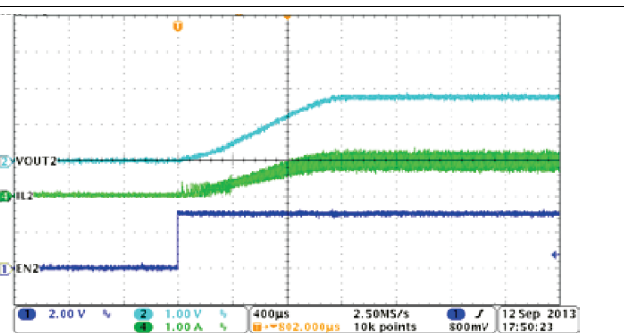

Figure 34. PSM Mode Buck2, Soft-Start With Full Load

TPS65262-2

ZHCSEM0B – DECEMBER 2015 – REVISED JULY 2019

www.ti.com.cn

$T_A = 25^\circ\text{C}$, $V_{IN} = 12\text{ V}$, $V_{OUT1} = 1.2\text{ V}$, $V_{OUT2} = 1.8\text{ V}$, $V_{OUT3} = 3.3\text{ V}$, $f_{SW} = 600\text{ kHz}$, PSM mode (unless otherwise noted)

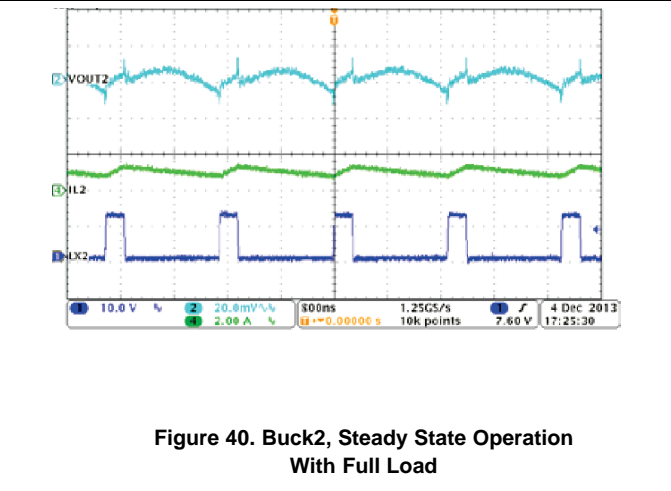
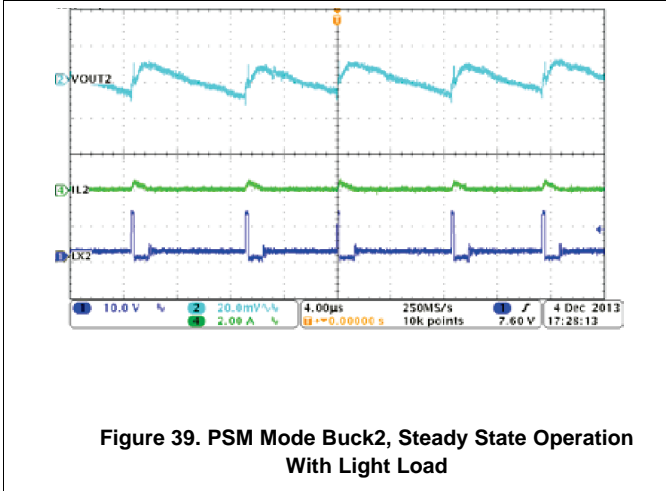
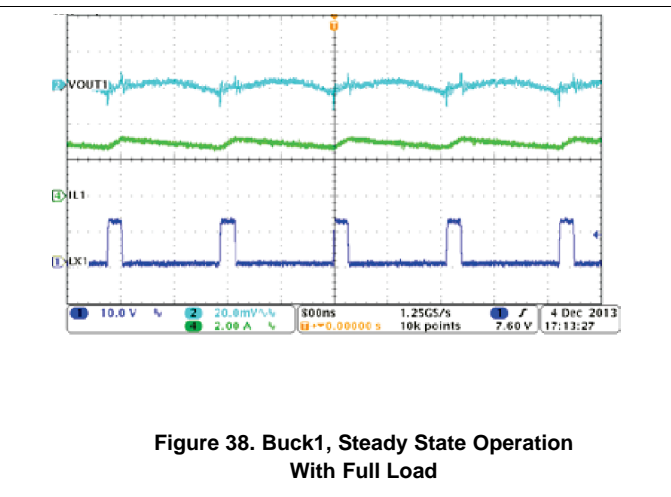
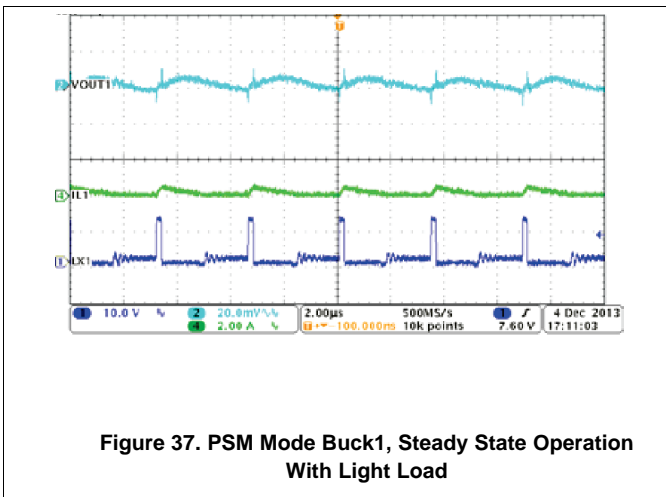
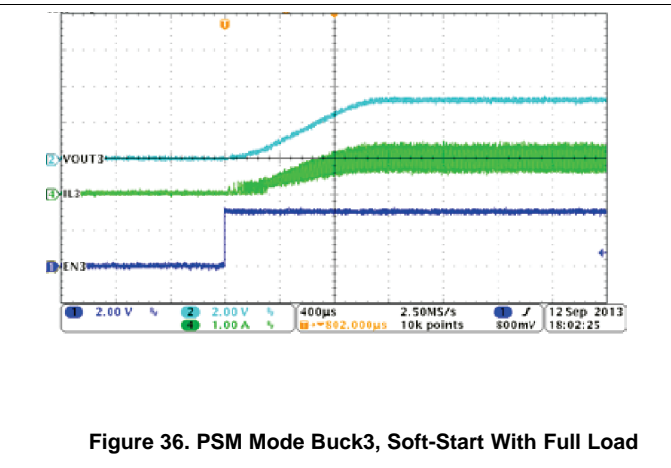
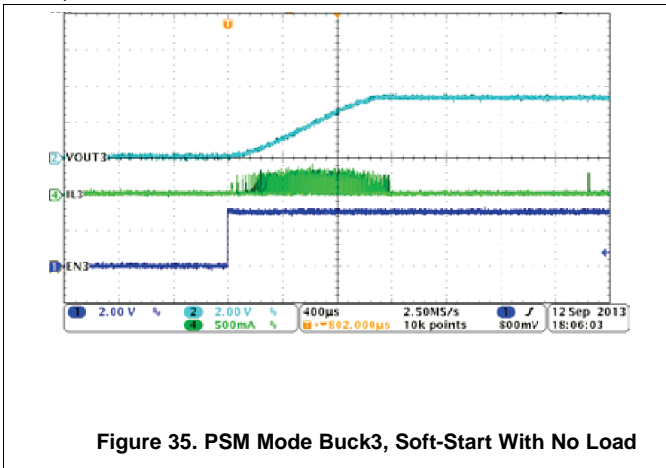

$T_A = 25^\circ\text{C}$, $V_{IN} = 12\text{ V}$, $V_{OUT1} = 1.2\text{ V}$, $V_{OUT2} = 1.8\text{ V}$, $V_{OUT3} = 3.3\text{ V}$, $f_{SW} = 600\text{ kHz}$, PSM mode (unless otherwise noted)

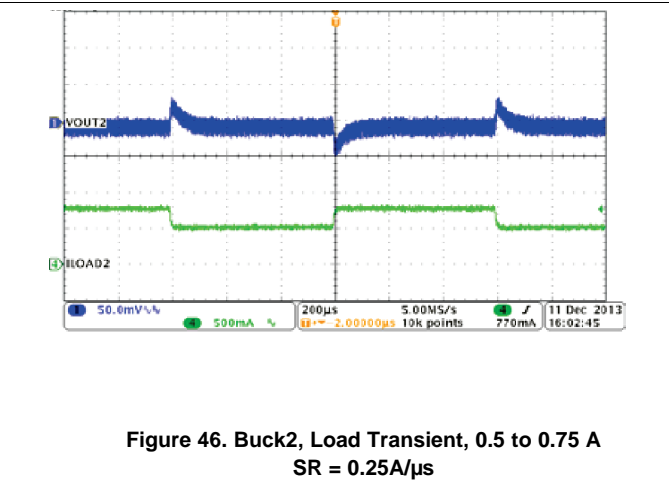
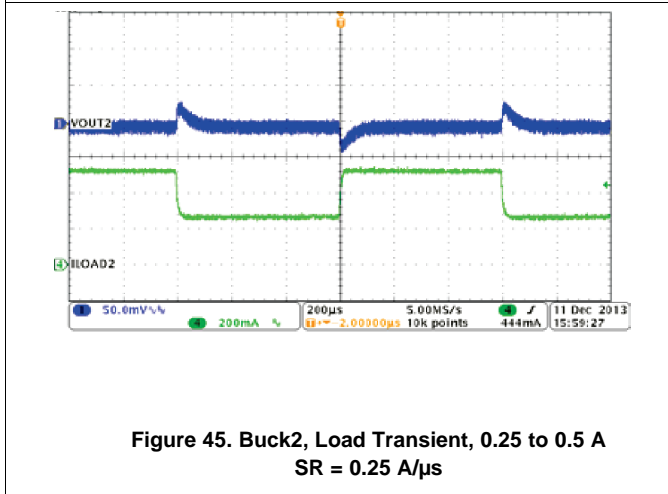
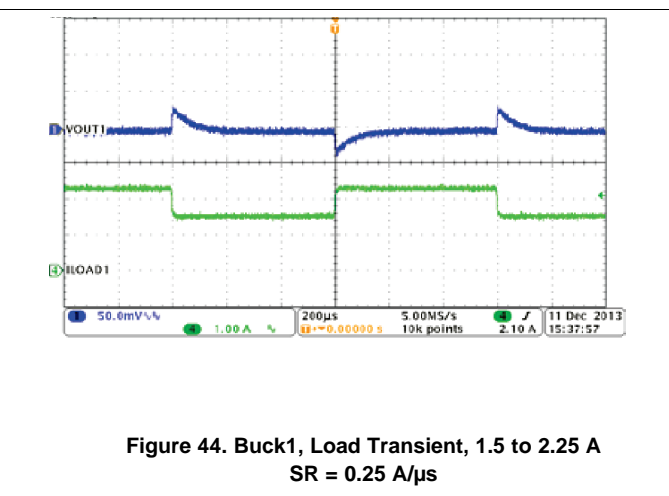
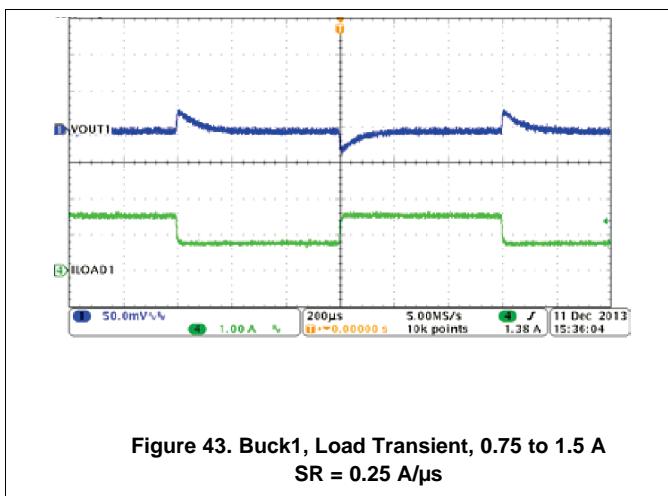
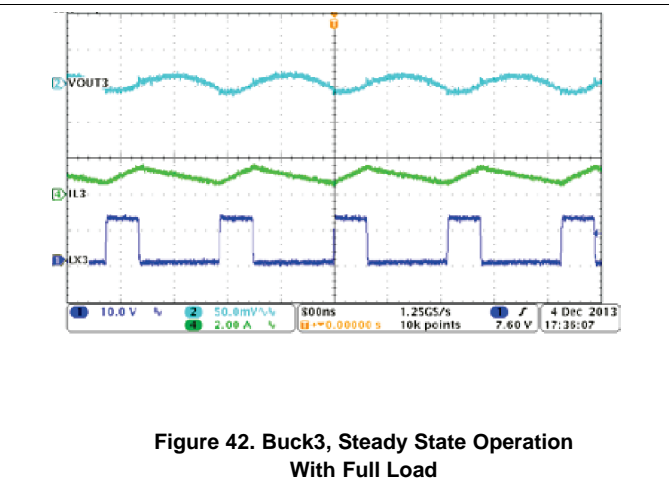
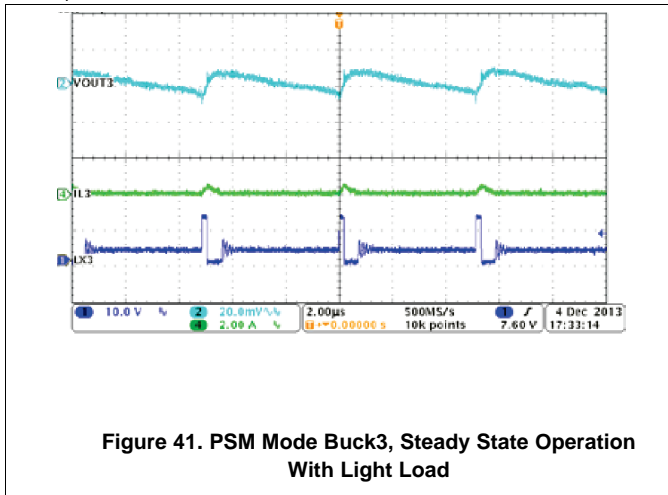

$T_A = 25^\circ\text{C}$, $V_{IN} = 12\text{ V}$, $V_{OUT1} = 1.2\text{ V}$, $V_{OUT2} = 1.8\text{ V}$, $V_{OUT3} = 3.3\text{ V}$, $f_{SW} = 600\text{ kHz}$, PSM mode (unless otherwise noted)

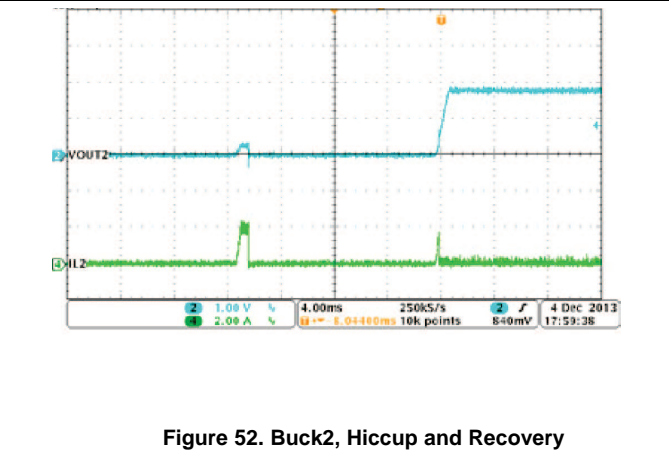
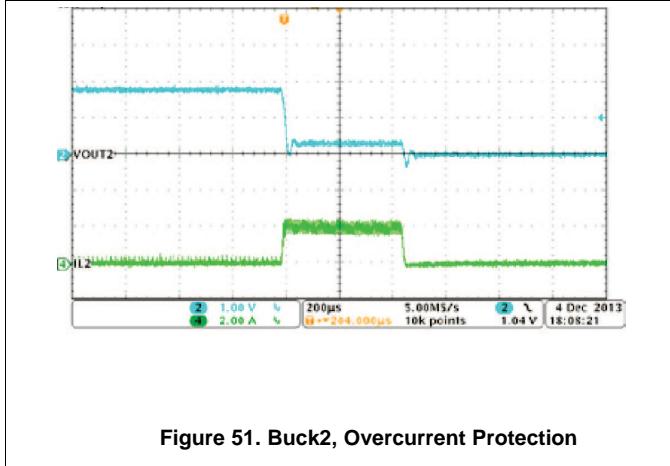
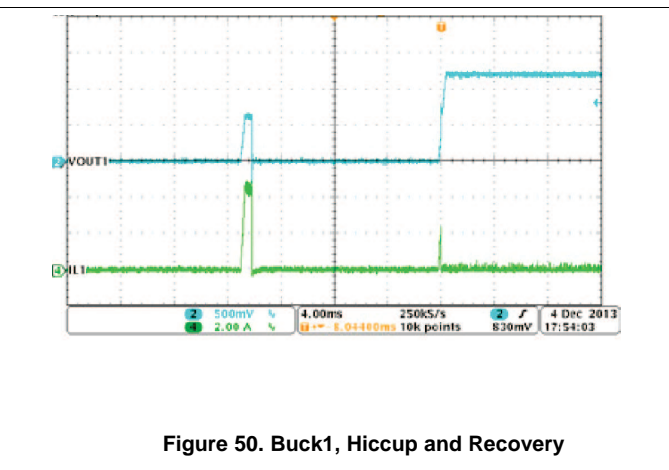
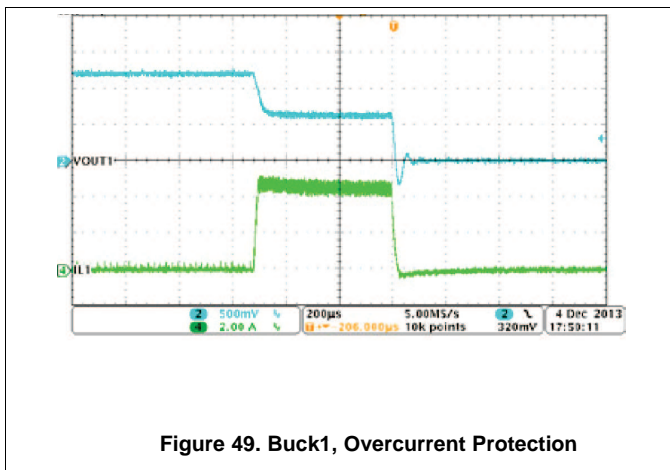
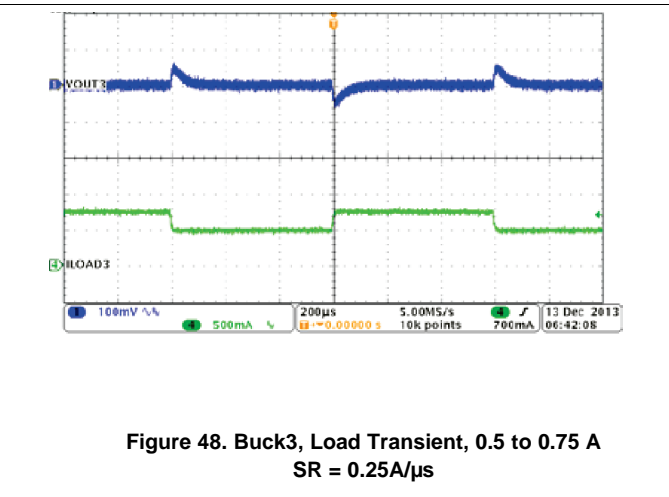
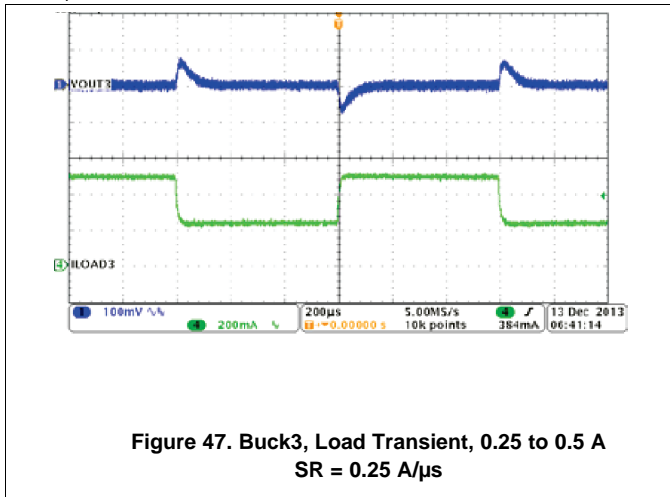

$T_A = 25^\circ\text{C}$, $V_{IN} = 12\text{ V}$, $V_{OUT1} = 1.2\text{ V}$, $V_{OUT2} = 1.8\text{ V}$, $V_{OUT3} = 3.3\text{ V}$, $f_{SW} = 600\text{ kHz}$, PSM mode (unless otherwise noted)

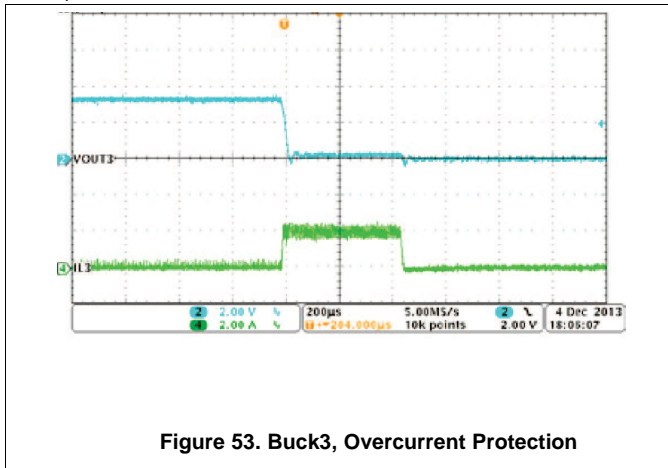

Figure 53. Buck3, Overcurrent Protection

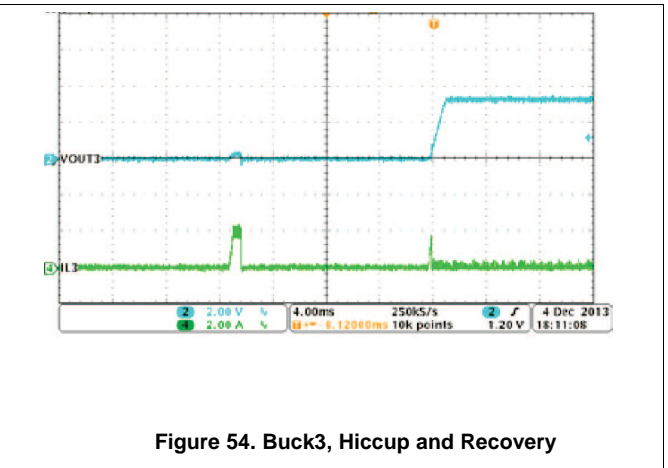

Figure 54. Buck3, Hiccup and Recovery

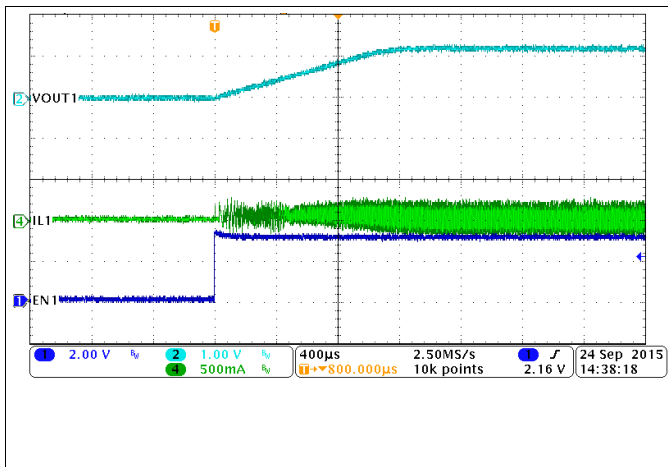

Figure 55. PWM Mode, Buck1, Soft-Start With No Load

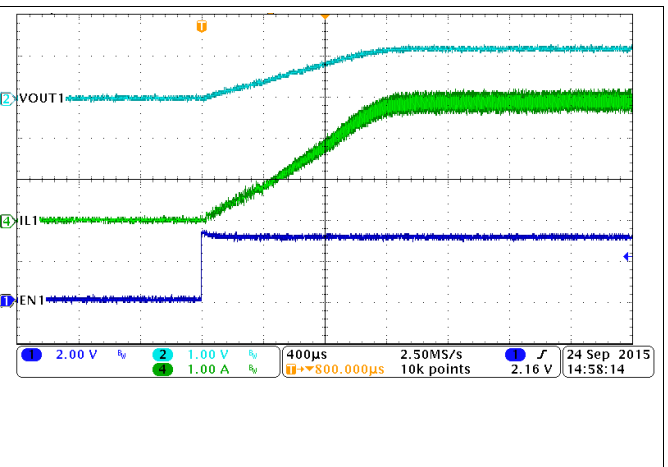

Figure 56. PWM Mode, Buck1, Soft-Start With Full Load

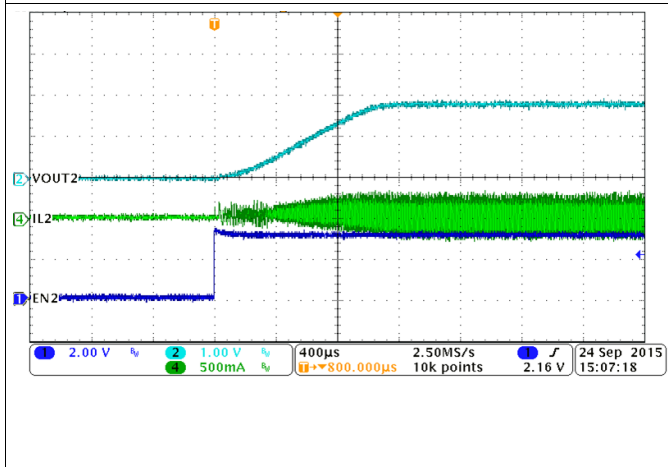

Figure 57. PWM Mode, Buck2, Soft-Start With No Load

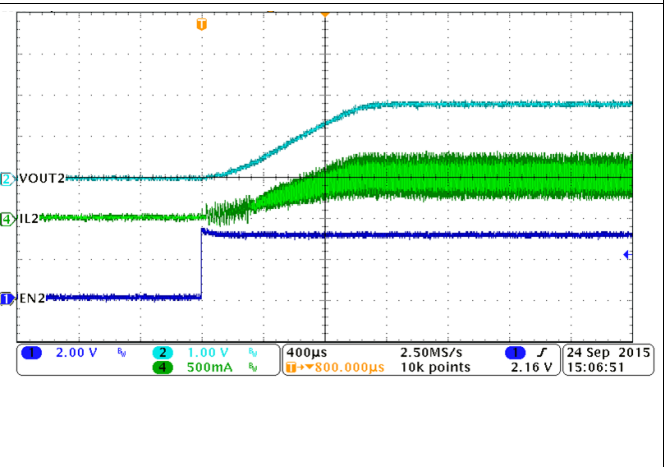

Figure 58. PWM Mode, Buck2, Soft-Start With Full Load

TPS65262-2

ZHCSEM0B – DECEMBER 2015 – REVISED JULY 2019

www.ti.com.cn

$T_A = 25^\circ\text{C}$, $V_{IN} = 12\text{ V}$, $V_{OUT1} = 1.2\text{ V}$, $V_{OUT2} = 1.8\text{ V}$, $V_{OUT3} = 3.3\text{ V}$, $f_{SW} = 600\text{ kHz}$, PSM mode (unless otherwise noted)

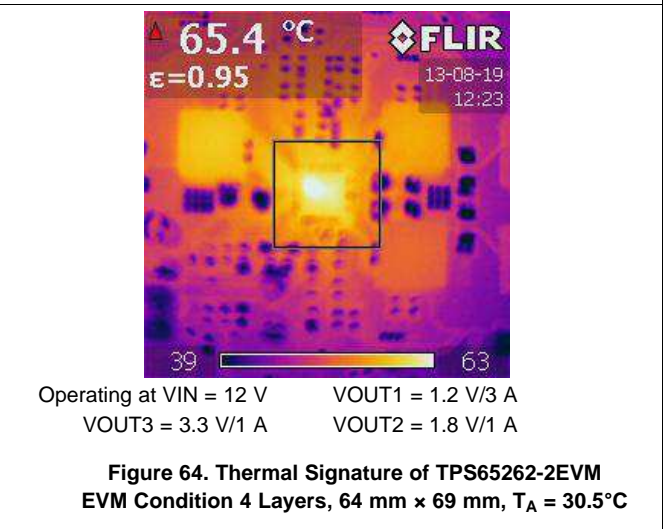
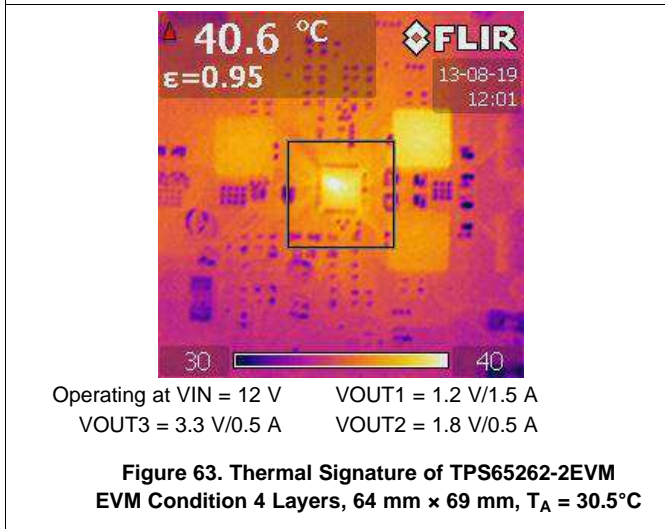
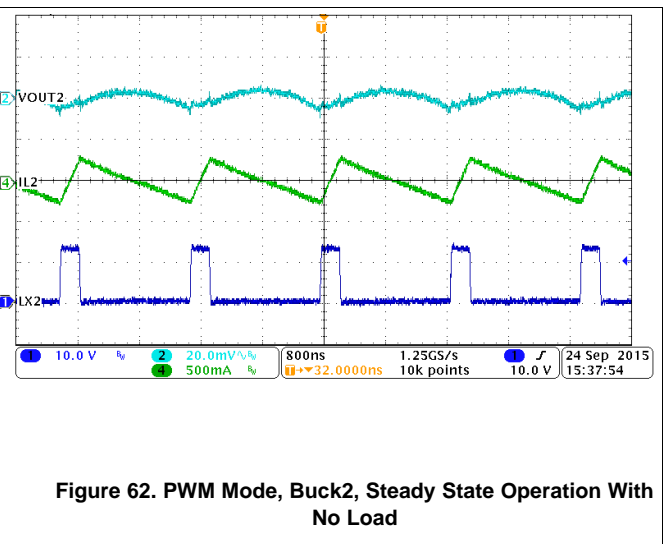
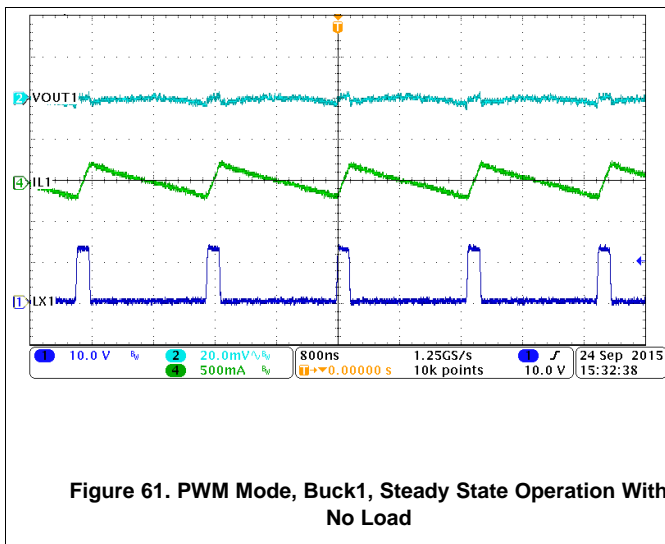
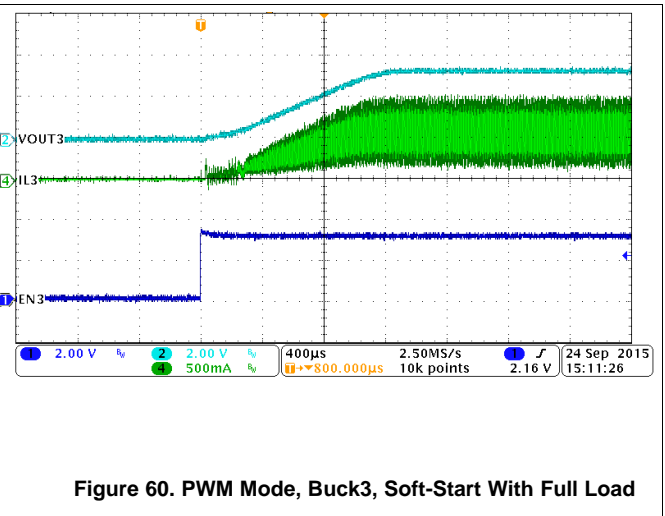
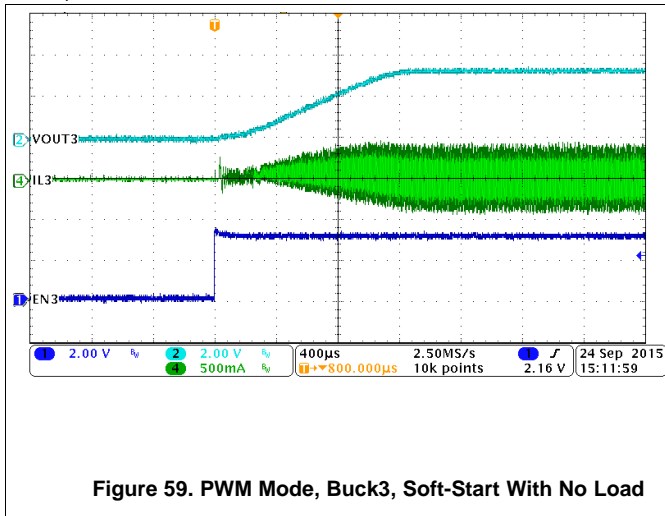

9 Power Supply Recommendations

A wide 4.5- to 18-V input supply voltage range encompasses the most intermediate bus voltage operating off 5-, 9-, 12-, or 15-V power bus. The converter, with constant frequency peak current mode, is designed to simplify its application while giving designers options to optimize the system according to targeted applications.

10 Layout

10.1 Layout Guidelines

The TPS65262-2 supports a 2-layer PCB layout, shown in [Figure 65](#).

Layout is a critical portion of good power supply design. See [Figure 65](#) for a PCB layout example. The top contains the main power traces for VIN, VOUT, and LX. Also on the top layer are connections for the remaining pins of the TPS65262-2 and a large top side area filled with ground. The top layer ground area should be connected to the bottom layer ground using vias at the input bypass capacitor, the output filter capacitor and directly under the TPS65262-2 device to provide a thermal path from the exposed thermal pad land to ground. The bottom layer acts as ground plane connecting analog ground and power ground.

For operation at full rated load, the top side ground area together with the bottom side ground plane must provide adequate heat dissipating area. There are several signals paths that conduct fast changing currents or voltages that can interact with stray inductance or parasitic capacitance to generate noise or degrade the power supplies performance. To help eliminate these problems, the VIN pin should be bypassed to ground with a low ESR ceramic bypass capacitor with X5R or X7R dielectric. Care should be taken to minimize the loop area formed by the bypass capacitor connections, the VIN pins, and the ground connections. The VIN pin must also be bypassed to ground using a low-ESR ceramic capacitor with X5R or X7R dielectric.

Since the LX connection is the switching node, the output inductor should be located close to the LX pins, and the area of the PCB conductor minimized to prevent excessive capacitive coupling. The output filter capacitor ground should use the same power ground trace as the VIN input bypass capacitor. Try to minimize this conductor length while maintaining adequate width. The small signal components should be grounded to the analog ground path.

The FB and COMP pins are sensitive to noise so the resistors and capacitors should be located as close as possible to the IC and routed with minimal lengths of trace. The additional external components can be placed approximately as shown.

10.2 Layout Example

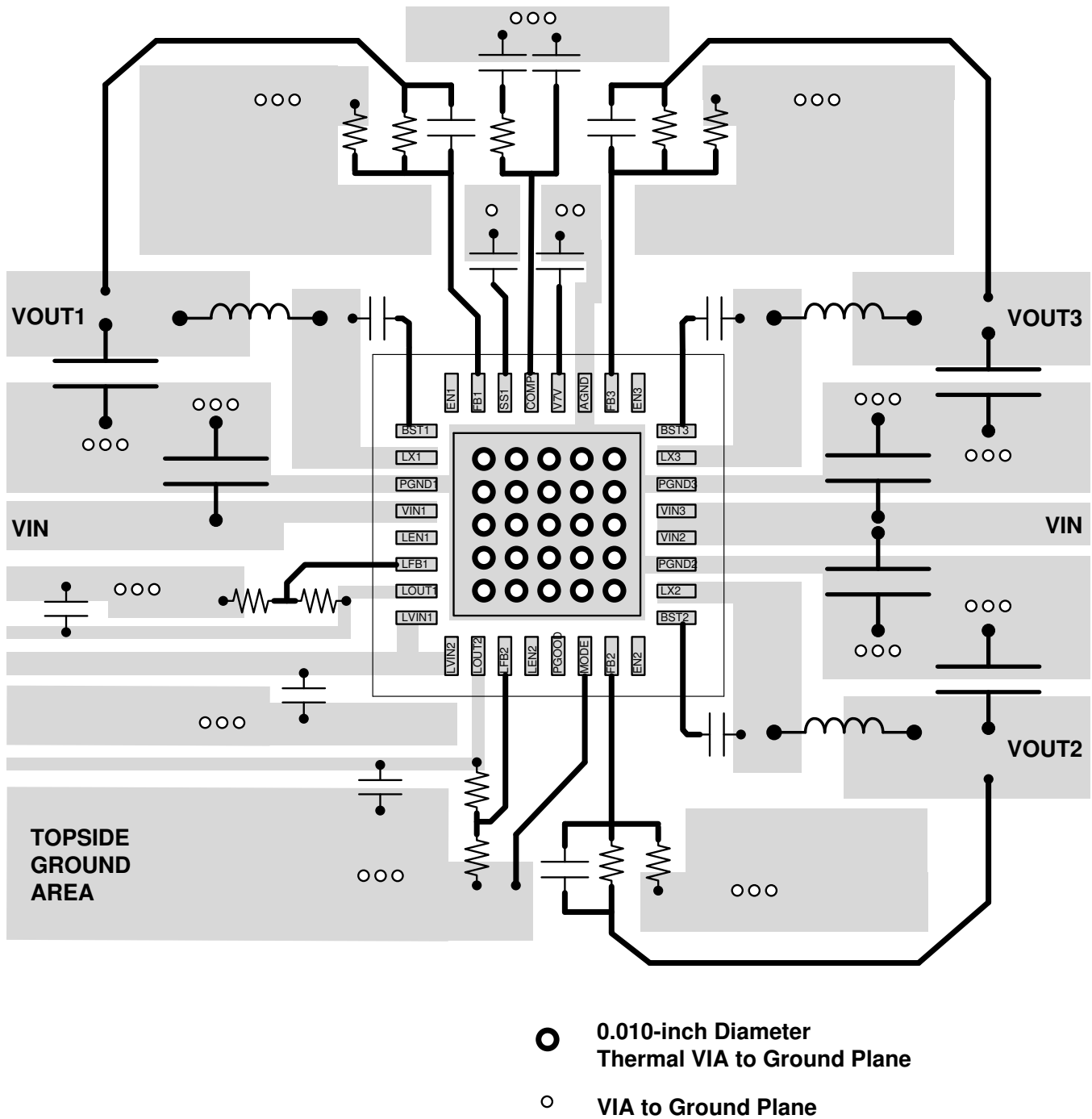

Figure 65. PCB Layout

11 器件和文档支持

11.1 社区资源

The following links connect to TI community resources. Linked contents are provided "AS IS" by the respective contributors. They do not constitute TI specifications and do not necessarily reflect TI's views; see TI's [Terms of Use](#).

TI E2E™ Online Community *TI's Engineer-to-Engineer (E2E) Community*. Created to foster collaboration among engineers. At e2e.ti.com, you can ask questions, share knowledge, explore ideas and help solve problems with fellow engineers.

Design Support *TI's Design Support* Quickly find helpful E2E forums along with design support tools and contact information for technical support.

11.2 商标

E2E is a trademark of Texas Instruments.
All other trademarks are the property of their respective owners.

11.3 静电放电警告



这些装置包含有限的内置 ESD 保护。存储或装卸时，应将导线一起截短或将装置放置于导电泡棉中，以防止 MOS 门极遭受静电损伤。

11.4 Glossary



[SLYZ022](#) — *TI Glossary*.

This glossary lists and explains terms, acronyms, and definitions.

12 机械、封装和可订购信息

以下页面包含机械、封装和可订购信息。这些信息是指定器件的最新可用数据。数据如有变更，恕不另行通知，且不会对此文档进行修订。如需获取此数据表的浏览器版本，请查阅左侧的导航栏。

PACKAGING INFORMATION

Orderable Device	Status (1)	Package Type	Package Drawing	Pins	Package Qty	Eco Plan (2)	Lead finish/ Ball material (6)	MSL Peak Temp (3)	Op Temp (°C)	Device Marking (4/5)	Samples
TPS65262-2RHBR	ACTIVE	VQFN	RHB	32	3000	RoHS & Green	NIPDAU	Level-2-260C-1 YEAR	-40 to 85	TPS 65262-2	
TPS65262-2RHBT	ACTIVE	VQFN	RHB	32	250	RoHS & Green	NIPDAU	Level-2-260C-1 YEAR	-40 to 85	TPS 65262-2	

(1) The marketing status values are defined as follows:

ACTIVE: Product device recommended for new designs.

LIFEBUY: TI has announced that the device will be discontinued, and a lifetime-buy period is in effect.

NRND: Not recommended for new designs. Device is in production to support existing customers, but TI does not recommend using this part in a new design.

PREVIEW: Device has been announced but is not in production. Samples may or may not be available.

OBSOLETE: TI has discontinued the production of the device.

(2) **RoHS:** TI defines "RoHS" to mean semiconductor products that are compliant with the current EU RoHS requirements for all 10 RoHS substances, including the requirement that RoHS substance do not exceed 0.1% by weight in homogeneous materials. Where designed to be soldered at high temperatures, "RoHS" products are suitable for use in specified lead-free processes. TI may reference these types of products as "Pb-Free".

RoHS Exempt: TI defines "RoHS Exempt" to mean products that contain lead but are compliant with EU RoHS pursuant to a specific EU RoHS exemption.

Green: TI defines "Green" to mean the content of Chlorine (Cl) and Bromine (Br) based flame retardants meet JS709B low halogen requirements of <=1000ppm threshold. Antimony trioxide based flame retardants must also meet the <=1000ppm threshold requirement.

(3) MSL, Peak Temp. - The Moisture Sensitivity Level rating according to the JEDEC industry standard classifications, and peak solder temperature.

(4) There may be additional marking, which relates to the logo, the lot trace code information, or the environmental category on the device.

(5) Multiple Device Markings will be inside parentheses. Only one Device Marking contained in parentheses and separated by a "~" will appear on a device. If a line is indented then it is a continuation of the previous line and the two combined represent the entire Device Marking for that device.

(6) Lead finish/Ball material - Orderable Devices may have multiple material finish options. Finish options are separated by a vertical ruled line. Lead finish/Ball material values may wrap to two lines if the finish value exceeds the maximum column width.

Important Information and Disclaimer:The information provided on this page represents TI's knowledge and belief as of the date that it is provided. TI bases its knowledge and belief on information provided by third parties, and makes no representation or warranty as to the accuracy of such information. Efforts are underway to better integrate information from third parties. TI has taken and continues to take reasonable steps to provide representative and accurate information but may not have conducted destructive testing or chemical analysis on incoming materials and chemicals. TI and TI suppliers consider certain information to be proprietary, and thus CAS numbers and other limited information may not be available for release.

In no event shall TI's liability arising out of such information exceed the total purchase price of the TI part(s) at issue in this document sold by TI to Customer on an annual basis.

TAPE AND REEL INFORMATION

QUADRANT ASSIGNMENTS FOR PIN 1 ORIENTATION IN TAPE

*All dimensions are nominal

Device	Package Type	Package Drawing	Pins	SPQ	Reel Diameter (mm)	Reel Width W1 (mm)	A0 (mm)	B0 (mm)	K0 (mm)	P1 (mm)	W (mm)	Pin1 Quadrant
TPS65262-2RHBR	VQFN	RHB	32	3000	330.0	12.4	5.3	5.3	1.1	8.0	12.0	Q2
TPS65262-2RHBT	VQFN	RHB	32	250	180.0	12.4	5.3	5.3	1.1	8.0	12.0	Q2

TAPE AND REEL BOX DIMENSIONS

*All dimensions are nominal

Device	Package Type	Package Drawing	Pins	SPQ	Length (mm)	Width (mm)	Height (mm)
TPS65262-2RHBR	VQFN	RHB	32	3000	367.0	367.0	35.0
TPS65262-2RHBT	VQFN	RHB	32	250	210.0	185.0	35.0

GENERIC PACKAGE VIEW

RHB 32

VQFN - 1 mm max height

5 x 5, 0.5 mm pitch

PLASTIC QUAD FLATPACK - NO LEAD



Images above are just a representation of the package family, actual package may vary.
Refer to the product data sheet for package details.

4224745/A

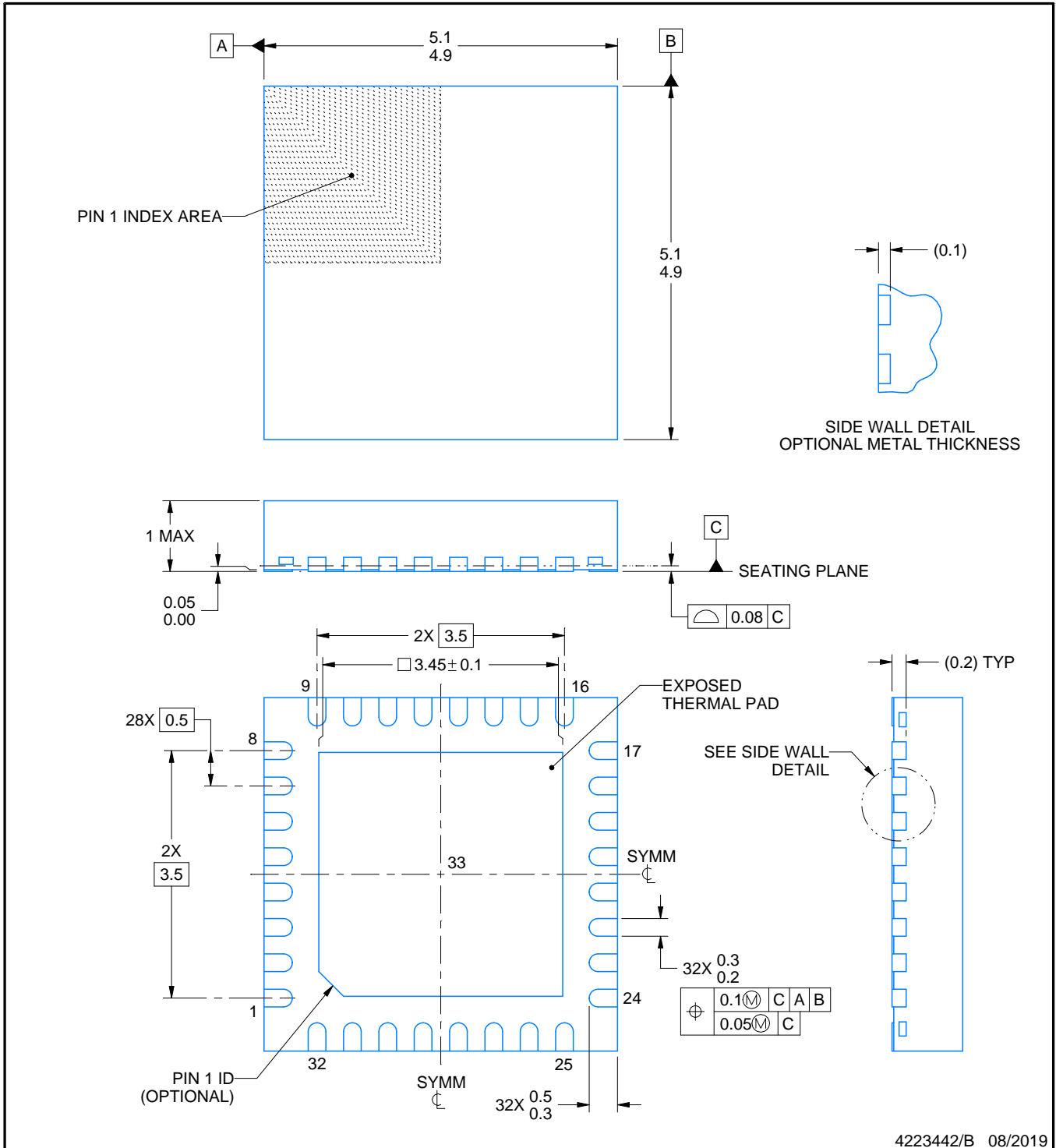

4223442/B 08/2019

NOTES:

1. All linear dimensions are in millimeters. Any dimensions in parenthesis are for reference only. Dimensioning and tolerancing per ASME Y14.5M.
2. This drawing is subject to change without notice.
3. The package thermal pad must be soldered to the printed circuit board for thermal and mechanical performance.

EXAMPLE BOARD LAYOUT

RHB0032E

VQFN - 1 mm max height

PLASTIC QUAD FLATPACK - NO LEAD



LAND PATTERN EXAMPLE
SCALE:18X



SOLDER MASK DETAILS

4223442/B 08/2019

NOTES: (continued)

4. This package is designed to be soldered to a thermal pad on the board. For more information, see Texas Instruments literature number SLUA271 (www.ti.com/lit/sluea271).
5. Vias are optional depending on application, refer to device data sheet. If any vias are implemented, refer to their locations shown on this view. It is recommended that vias under paste be filled, plugged or tented.

EXAMPLE STENCIL DESIGN

RHB0032E

VQFN - 1 mm max height

PLASTIC QUAD FLATPACK - NO LEAD

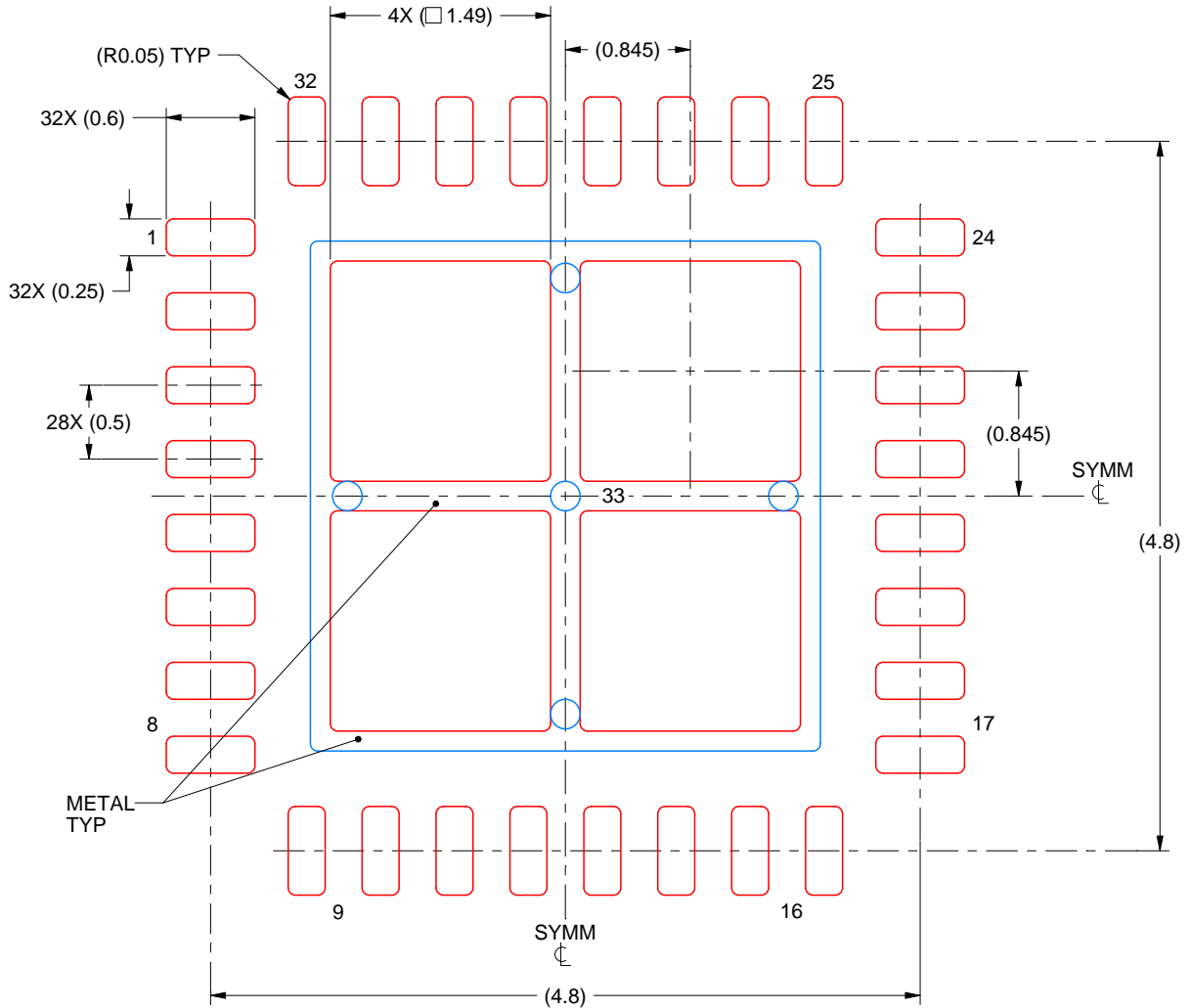

SOLDER PASTE EXAMPLE
BASED ON 0.125 mm THICK STENCIL

EXPOSED PAD 33:
75% PRINTED SOLDER COVERAGE BY AREA UNDER PACKAGE
SCALE:20X

4223442/B 08/2019

NOTES: (continued)

6. Laser cutting apertures with trapezoidal walls and rounded corners may offer better paste release. IPC-7525 may have alternate design recommendations.

重要声明和免责声明

TI“按原样”提供技术和可靠性数据（包括数据表）、设计资源（包括参考设计）、应用或其他设计建议、网络工具、安全信息和其他资源，不保证没有瑕疵且不做任何明示或暗示的担保，包括但不限于对适销性、某特定用途方面的适用性或不侵犯任何第三方知识产权的暗示担保。

这些资源可供使用 TI 产品进行设计的熟练开发人员使用。您将自行承担以下全部责任：(1) 针对您的应用选择合适的 TI 产品，(2) 设计、验证并测试您的应用，(3) 确保您的应用满足相应标准以及任何其他功能安全、信息安全、监管或其他要求。

这些资源如有变更，恕不另行通知。TI 授权您仅可将这些资源用于研发本资源所述的 TI 产品的应用。严禁对这些资源进行其他复制或展示。您无权使用任何其他 TI 知识产权或任何第三方知识产权。您应全额赔偿因在这些资源的使用中对 TI 及其代表造成的任何索赔、损害、成本、损失和债务，TI 对此概不负责。

TI 提供的产品受 [TI 的销售条款](#) 或 [ti.com](#) 上其他适用条款/TI 产品随附的其他适用条款的约束。TI 提供这些资源并不会扩展或以其他方式更改 TI 针对 TI 产品发布的适用的担保或担保免责声明。

TI 反对并拒绝您可能提出的任何其他或不同的条款。

邮寄地址：Texas Instruments, Post Office Box 655303, Dallas, Texas 75265

Copyright © 2022，德州仪器 (TI) 公司

X-ON Electronics

Largest Supplier of Electrical and Electronic Components

Click to view similar products for [Switching Voltage Regulators](#) category:

Click to view products by [Texas Instruments](#) manufacturer:

Other Similar products are found below :

[FAN53610AUC33X](#) [FAN53611AUC123X](#) [EN6310QA](#) [160215](#) [R3](#) [KE177614](#) [FAN53611AUC12X](#) [MAX809TTR](#) [NCV891234MW50R2G](#)
[AST1S31PUR](#) [NCP81203PMNTXG](#) [NCP81208MNTXG](#) [PCA9412AUKZ](#) [NCP81109GMNTXG](#) [NCP3235MNTXG](#) [NCP81109JMNTXG](#)
[NCP81241MNTXG](#) [NTE7223](#) [NTE7222](#) [NTE7224](#) [L6986FTR](#) [MPQ4481GU-AEC1-P](#) [MP8756GD-P](#) [MPQ2171GJ-P](#) [MPQ2171GJ-AEC1-P](#)
[N JW4153U2-A-TE2](#) [MP2171GJ-P](#) [MP28160GC-Z](#) [XDPE132G5CG000XUMA1](#) [LM60440AQRPKRQ1](#) [MP5461GC-P](#) [IW673-20](#)
[NCV896530MWATXG](#) [MPQ4409GQBE-AEC1-P](#) [S-19903DA-A8T1U7](#) [S-19903CA-A6T8U7](#) [S-19903CA-S8T1U7](#) [S-19902BA-A6T8U7](#)
[S-19902CA-A6T8U7](#) [S-19902AA-A6T8U7](#) [S-19903AA-A6T8U7](#) [S-19902AA-S8T1U7](#) [S-19902BA-A8T1U7](#) [AU8310](#)
[LMR23615QDRRRQ1](#) [LMR33630APAQRN XRQ1](#) [LMR33630APCQRN XRQ1](#) [LMR36503R5RPER](#) [LMR36503RFRPER](#)
[LMR36503RS3QRPERQ1](#)