

## TPS720-Q1

### 具有偏置引脚的 350mA、超低 $V_{IN}$ 、RF 低压降线性稳压器

#### 1 特性

- 适用于汽车电子 应用
- 具有符合 AEC-Q100 标准的下列结果：
  - 器件温度 1 级：-40°C 至 +125°C 的环境运行温度范围
  - 器件人体放电模式 (HBM) 静电放电 (ESD) 分类等级 H2
  - 器件组件充电模式 (CDM) ESD 分类等级 C6
- 输入电压范围：1.1V 至 4.5V
- 输出电压范围：0.9V 至 3.6V
- 高性能 LDO：350mA
- 低静态电流：38 $\mu$ A
- 绝佳的负载瞬态响应：
  - $\pm 15\text{mV}$ （当 1 $\mu$ s 内  $I_{LOAD} = 0\text{mA}$  跳至 350 mA 时）
- 低噪声：48 $\mu$ V<sub>RMS</sub>（10Hz 至 100kHz）
- 80dB  $V_{IN}$  PSRR（10Hz 至 10kHz）
- 70dB  $V_{BIAS}$  PSRR（10Hz 至 10kHz）
- 快速启动时间：140 $\mu$ s
- 内置软启动，单调  $V_{OUT}$  升高并且启动电流限制在  $100\text{mA} + I_{LOAD}$
- 过流和热保护
- 低压降：110mV（当  $I_{LOAD} = 350\text{mA}$  时）
- 与 2.2 $\mu$ F 输出电容一起工作时保持稳定
- 封装：2.00mm x 2.00mm、6 引脚 WSON

#### 2 应用

- 摄像机模块
- 平板显示 (FPD) 链路电源
- 车用信息娱乐系统
- USB 网络集线器 (HUB) 电源

#### 3 说明

TPS720-Q1 系列双轨、低压降线性稳压器 (LDO) 具有出色的交流性能 (PSRR, 负载和线路瞬态响应), 静态流耗非常低, 低至 38 $\mu$ A。

为 LDO 控制电路供电的  $V_{BIAS}$  轨消耗极低的电流 (与 LDO 静态电流差不多), 并且可以连接至任何超过输出电压 1.4V 及以上的电源。主要电源路径为  $V_{IN}$ , 且可低于  $V_{BIAS}$ ; 此路径可低至  $V_{OUT} + V_{DO}$ , 有助于提高许多功耗敏感型应用解决方案的效率。例如,  $V_{IN}$  可作为高效的直流 - 直流降压稳压器的输出。

TPS720-Q1 支持一种新特性, 当 IN 引脚保持悬空时, LDO 的输出稳定在轻负载以下。这种情况下的轻负载驱动电流来源于  $V_{BIAS}$ 。此特性对于节能应用特别有效, 在这些应用中, 禁止直流-直流转换器连接至 IN 引脚, 但仍需要 LDO 将电压稳定至轻负载。

TPS720-Q1 与陶瓷电容器搭配使用时可保持稳定, 并且该器件使用先进的 BICMOS 制造工艺, 能够在 350mA 输出负载电流时产生仅 110mV 的降压。TPS720-Q1 搭配 2.2 $\mu$ F 输出电容时, 可实现  $V_{OUT}$  单调升高 (过冲限制为 3%) 的同时  $V_{IN}$  浪涌电流限制为  $100\text{mA} + I_{LOAD}$ 。

TPS720-Q1 使用一个高精度电压基准和反馈环路来实现负载、线路、过程和温度变化范围上 2% 的总精度。TPS720-Q1 采用 6 引脚 WSON 封装。该系列器件的额定工作温度范围为  $T_J = -40^\circ\text{C}$  至  $+125^\circ\text{C}$ 。

#### 器件信息<sup>(1)</sup>

器件型号	封装	封装尺寸 (标称值)
TPS720-Q1	WSON (6)	2.00mm x 2.00mm

(1) 要了解所有可用封装, 请见数据表末尾的可订购产品附录。

简化电路原理图

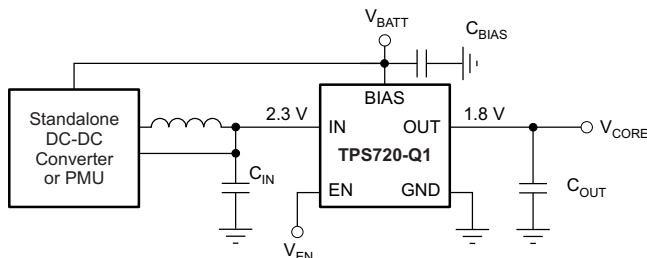

## 目录

<b>1</b>	<b>特性</b> .....	<b>1</b>	<b>8</b>	<b>Application and Implementation</b> .....	<b>13</b>
<b>2</b>	<b>应用</b> .....	<b>1</b>	8.1	Application Information.....	13
<b>3</b>	<b>说明</b> .....	<b>1</b>	8.2	Typical Application .....	14
<b>4</b>	<b>修订历史记录</b> .....	<b>2</b>	<b>9</b>	<b>Power Supply Recommendations</b> .....	<b>16</b>
<b>5</b>	<b>Pin Configuration and Functions</b> .....	<b>3</b>	<b>10</b>	<b>Layout</b> .....	<b>16</b>
<b>6</b>	<b>Specifications</b> .....	<b>3</b>	10.1	Layout Guidelines .....	16
6.1	Absolute Maximum Ratings .....	3	10.2	Layout Example .....	16
6.2	ESD Ratings.....	4	10.3	Thermal Considerations .....	17
6.3	Recommended Operating Conditions.....	4	10.4	Power Dissipation .....	17
6.4	Thermal Information .....	4	<b>11</b>	<b>器件和文档支持</b> .....	<b>18</b>
6.5	Electrical Characteristics.....	5	11.1	器件支持 .....	18
6.6	Timing Requirements .....	6	11.2	文档支持 .....	18
6.7	Typical Characteristics .....	7	11.3	接收文档更新通知 .....	18
<b>7</b>	<b>Detailed Description</b> .....	<b>11</b>	11.4	社区资源 .....	18
7.1	Overview .....	11	11.5	商标 .....	18
7.2	Functional Block Diagram .....	11	11.6	静电放电警告 .....	19
7.3	Feature Description.....	11	11.7	Glossary .....	19
7.4	Device Functional Modes.....	12	<b>12</b>	<b>机械、封装和可订购信息</b> .....	<b>19</b>

## 4 修订历史记录

<b>Changes from Original (February 2016) to Revision A</b>	<b>Page</b>
• 已更改 特性部分中的输出电压范围要点从“0.9V 至 3.0V”更改为“0.9V 至 3.6V” .....	1
• Changed maximum value of "output voltage" parameter from 3.0 V to 3.6 V in <i>Recommended Operating Conditions</i> table .....	4
• Reformatted <i>Thermal Information</i> table note .....	4
• Changed maximum value of <i>output voltage</i> parameter from 3.0 V to 3.6 V in <i>Electrical Characteristics</i> table .....	5
• 已更改 器件命名规则部分 .....	18
• 已更改 相关文档部分的格式 .....	18
• 已添加 接收文档更新通知部分 .....	18

## 5 Pin Configuration and Functions

**DRV Package  
6-Pin WSON With Exposed Thermal Pad  
Top View**

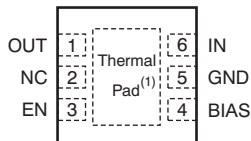

(1) TI recommends connecting the WSON (DRV) package thermal pad to ground.

### Pin Functions

PIN		I/O	DESCRIPTION
NAME	NO.		
OUT	1	O	Output pin. A 2.2- $\mu$ F ceramic capacitor is connected from this pin to ground for stability and to provide load transients; see <a href="#">Input and Output Capacitor Requirements</a>
NC	2	—	No connection.
EN	3	I	Enable pin. A logic high signal on this pin turns the device on and regulates the voltage from IN to OUT. A logic low on this pin turns the device off.
BIAS	4	I	Bias supply pin. For better transient performance, TI recommends bypassing this input with a ceramic capacitor to ground; see <a href="#">Input and Output Capacitor Requirements</a>
GND	5	—	Ground pin.
IN	6	I	Input pin. This pin can be a maximum of 4.5 V; $V_{IN}$ must not exceed $V_{BIAS}$ . Bypass this input with a ceramic capacitor to ground; see <a href="#">Input and Output Capacitor Requirements</a> .

## 6 Specifications

### 6.1 Absolute Maximum Ratings

at  $T_J = -40^\circ\text{C}$  to  $+125^\circ\text{C}$  (unless otherwise noted); all voltages are with respect to GND<sup>(1)</sup>

		MIN	MAX	UNIT
$V_{IN}^{(2)}$	Input voltage (steady-state)	-0.3	$V_{BIAS}$ or 5 <sup>(3)</sup>	V
$V_{IN\_PEAK}^{(4)}$	Peak transient input		5.5	V
$V_{BIAS}$	Bias voltage	-0.3	6	V
$V_{EN}$	Enable voltage	-0.3	6	V
$V_{OUT}$	Output voltage	-0.3	5	V
$I_{OUT}$	Peak output current	Internally limited		
	Output short-circuit duration	Indefinite		
$P_{DISS}$	Total continuous power dissipation	See <a href="#">Thermal Information</a>		
$T_J$	Operating junction temperature	-55	125	$^\circ\text{C}$
$T_{stg}$	Storage temperature	-55	150	$^\circ\text{C}$

- (1) Stresses beyond those listed under *Absolute Maximum Ratings* may cause permanent damage to the device. These are stress ratings only, which do not imply functional operation of the device at these or any other conditions beyond those indicated under *Recommended Operating Conditions*. Exposure to absolute-maximum-rated conditions for extended periods may affect device reliability.
- (2) To ensure proper device operation,  $V_{IN}$  must be less than or equal to  $V_{BIAS}$  under all conditions.
- (3) Whichever is less.
- (4) For durations no longer than 1 ms each, for a total of no more than 1000 occurrences over the lifetime of the device.

## 6.2 ESD Ratings

		VALUE	UNIT
$V_{(ESD)}$	Electrostatic discharge	Human-body model (HBM), per ANSI/ESDA/JEDEC JS-001 <sup>(1)</sup>	±2000
		Charged-device model (CDM), per JEDEC specification JESD22-C101 <sup>(2)</sup>	±500
		Machine model (MM)	±100

- (1) JEDEC document JEP155 states that 500-V HBM allows safe manufacturing with a standard ESD control process.  
 (2) JEDEC document JEP157 states that 250-V CDM allows safe manufacturing with a standard ESD control process.

## 6.3 Recommended Operating Conditions

over operating junction temperature range (unless otherwise noted).

		MIN	NOM	MAX	UNIT
$V_{IN}$	Input voltage (steady-state)	1.1		$V_{BIAS}$ or 4.5 <sup>(1)</sup>	V
$V_{BIAS}$	Bias voltage	2.6 or $V_{OUT} + 1.4$ <sup>(2)</sup>		5.5	V
$V_{OUT}$	Output voltage	0.9		3.6	V
$I_{OUT}$	Peak output current	0		350	mA
$V_{EN}$	Enable voltage	0		5.5	V
$C_{IN}$	Input capacitance		1		μF
$C_{BIAS}$	Bias capacitance		0.1		μF
$C_{OUT}$ <sup>(3)</sup>	Output capacitance	2.2			μF

- (1) Whichever is less.  
 (2) Whichever is greater.  
 (3) Maximum ESR must be less than 250 mΩ.

## 6.4 Thermal Information

THERMAL METRIC <sup>(1)</sup>		TPS720-Q1	UNIT
		DRV (WSON)	
		6 PINS	
$R_{\theta JA}$	Junction-to-ambient thermal resistance	66.5	°C/W
$R_{\theta JC(top)}$	Junction-to-case (top) thermal resistance	86.2	°C/W
$R_{\theta JB}$	Junction-to-board thermal resistance	36.1	°C/W
$\Psi_{JT}$	Junction-to-top characterization parameter	1.7	°C/W
$\Psi_{JB}$	Junction-to-board characterization parameter	36.6	°C/W
$R_{\theta JC(bot)}$	Junction-to-case (bottom) thermal resistance	7.4	°C/W

- (1) For more information about traditional and new thermal metrics, see [Semiconductor and IC Package Thermal Metrics](#) (SPRA953).

## 6.5 Electrical Characteristics

over operating temperature range ( $T_J = -40^\circ\text{C}$  to  $+125^\circ\text{C}$ ),  $V_{BIAS} = (V_{OUT} + 1.4\text{ V})$  or  $2.6\text{ V}$  (whichever is greater),  $V_{IN} \geq V_{OUT} + 0.5\text{ V}$ ,  $I_{OUT} = 1\text{ mA}$ ,  $V_{EN} = 1.1\text{ V}$ , and  $C_{OUT} = 2.2\text{ }\mu\text{F}$  (unless otherwise noted); typical values are at  $T_J = 25^\circ\text{C}$

PARAMETER		TEST CONDITIONS	MIN	TYP	MAX	UNIT
$V_{IN}$	Input voltage		1.1 <sup>(1)</sup>		$V_{BIAS}$ or 4.5 <sup>(2)</sup>	V
$V_{BIAS}$	Bias voltage		2.6		5.5	V
$V_{OUT}$ <sup>(3)</sup>	Output voltage <sup>(4)</sup>		0.9		3.6	V
	Output accuracy	Over $V_{BIAS}$ , $V_{IN}$ , $I_{OUT}$ , $T_J = -40^\circ\text{C}$ to $+125^\circ\text{C}$ $V_{OUT} + 1.4\text{ V} \leq V_{BIAS} \leq 5.5\text{ V}$ , $V_{OUT} + 0.5\text{ V} \leq V_{IN} \leq 4.5\text{ V}$ , $0\text{ mA} \leq I_{OUT} \leq 350\text{ mA}$	-2%		2%	
		Over $V_{BIAS}$ , $V_{IN}$ , $I_{OUT}$ , $T_J = -40^\circ\text{C}$ to $+125^\circ\text{C}$ $V_{OUT} + 1.4\text{ V} \leq V_{BIAS} \leq 5.5\text{ V}$ , $V_{OUT} + 0.5\text{ V} \leq V_{IN} \leq 4.5\text{ V}$ , $0\text{ mA} \leq I_{OUT} \leq 350\text{ mA}$ , $V_{OUT} < 1.2\text{ V}$	-25		25	mV
$V_{IN}$ floating	$V_{OUT} + 1.4\text{ V} \leq V_{BIAS} \leq 5.5\text{ V}$ , $0\text{ }\mu\text{A} \leq I_{OUT} \leq 500\text{ }\mu\text{A}$		$\pm 1\%$			
$\Delta V_{OUT}/\Delta V_{IN}$	$V_{IN}$ line regulation	$V_{IN} = (V_{OUT} + 0.5\text{ V})$ to $4.5\text{ V}$ , $I_{OUT} = 1\text{ mA}$		16		$\mu\text{V}/\text{V}$
$\Delta V_{OUT}/\Delta V_{BIAS}$	$V_{BIAS}$ line regulation	$V_{BIAS} = (V_{OUT} + 1.4\text{ V})$ or $2.6\text{ V}$ (whichever is greater) to $5.5\text{ V}$ , $I_{OUT} = 1\text{ mA}$		16		$\mu\text{V}/\text{V}$
	$V_{IN}$ line transient	$\Delta V_{IN} = 400\text{ mV}$ , $t_{RISE} = t_{FALL} = 1\text{ }\mu\text{s}$		$\pm 200$		$\mu\text{V}$
	$V_{BIAS}$ line transient	$\Delta V_{BIAS} = 600\text{ mV}$ , $t_{RISE} = t_{FALL} = 1\text{ }\mu\text{s}$		$\pm 0.8$		mV
$\Delta V_{OUT}/\Delta I_{OUT}$	Load regulation	$0\text{ mA} \leq I_{OUT} \leq 350\text{ mA}$ (no load to full load)		-15		$\mu\text{V}/\text{mA}$
	Load transient	$0\text{ mA} \leq I_{OUT} \leq 350\text{ mA}$ , $t_{RISE} = t_{FALL} = 1\text{ }\mu\text{s}$		$\pm 15$		mV
$V_{DO\_IN}$	$V_{IN}$ dropout voltage <sup>(5)</sup>	$V_{IN} = V_{OUT(NOM)} - 0.1\text{ V}$ , $(V_{BIAS} - V_{OUT(NOM)}) = 1.4\text{ V}$ , $I_{OUT} = 350\text{ mA}$		110	200	mV
$V_{DO\_BIAS}$	$V_{BIAS}$ dropout voltage <sup>(6)</sup>	$V_{IN} = V_{OUT(NOM)} + 0.3\text{ V}$ , $I_{OUT} = 350\text{ mA}$		1.09	1.4	V
$I_{CL}$	Output current limit	$V_{OUT} = 0.9 \times V_{OUT(NOM)}$	420	600	800	mA
$I_{GND}$	Ground pin current	$I_{OUT} = 100\text{ }\mu\text{A}$		38		$\mu\text{A}$
		$I_{OUT} = 0\text{ mA}$ to $350\text{ mA}$		54	80	
$I_{SHDN}$	Shutdown current ( $I_{GND}$ )	$V_{EN} \leq 0.4\text{ V}$		0.5	2.5	$\mu\text{A}$
PSRR	$V_{IN}$ power-supply rejection ratio	$V_{IN} - V_{OUT} \geq 0.5\text{ V}$ , $V_{BIAS} = V_{OUT} + 1.4\text{ V}$ , $I_{OUT} = 350\text{ mA}$	$f = 10\text{ Hz}$		85	dB
			$f = 100\text{ Hz}$		85	
			$f = 1\text{ kHz}$		85	
			$f = 10\text{ kHz}$		80	
			$f = 100\text{ kHz}$		70	
			$f = 1\text{ MHz}$		50	
PSRR	$V_{BIAS}$ power-supply rejection ratio	$V_{IN} - V_{OUT} \geq 0.5\text{ V}$ , $V_{BIAS} = V_{OUT} + 1.4\text{ V}$ , $I_{OUT} = 350\text{ mA}$	$f = 10\text{ Hz}$		80	dB
			$f = 100\text{ Hz}$		80	
			$f = 1\text{ kHz}$		75	
			$f = 10\text{ kHz}$		65	
			$f = 100\text{ kHz}$		55	
			$f = 1\text{ MHz}$		35	
$V_N$	Output noise voltage	Bandwidth = $10\text{ Hz}$ to $100\text{ kHz}$ , $V_{BIAS} \geq 2.6\text{ V}$ , $V_{IN} = V_{OUT} + 0.5\text{ V}$		48		$\mu\text{V}_{RMS}$
$I_{VIN\_INRUSH}$	Inrush current on $V_{IN}$	$V_{BIAS} = (V_{OUT} + 1.4\text{ V})$ or $2.6\text{ V}$ (whichever is greater), $V_{IN} = V_{OUT} + 0.5\text{ V}$		$100 + I_{LOAD}$		mA
$V_{EN(HI)}$	Enable pin high (enabled)		1.1			V
$V_{EN(LO)}$	Enable pin low (disabled)		0		0.4	V

(1) Performance specifications are ensured to a minimum  $V_{IN} = V_{OUT} + 0.5\text{ V}$ .

(2) Whichever is less.

(3) Minimum  $V_{BIAS} = (V_{OUT} + 1.4\text{ V})$  or  $2.6\text{ V}$  (whichever is greater) and  $V_{IN} = V_{OUT} + 0.5\text{ V}$ .

(4)  $V_O$  nominal value is factory programmable through the on-chip EEPROM.

(5) Measured for devices with  $V_{OUT(NOM)} \geq 1.2\text{ V}$ .

(6)  $V_{BIAS} - V_{OUT}$  with  $V_{OUT} = V_{OUT(NOM)} - 0.1\text{ V}$ . Measured for devices with  $V_{OUT(NOM)} \geq 1.8\text{ V}$ .

## Electrical Characteristics (continued)

over operating temperature range ( $T_J = -40^{\circ}\text{C}$  to  $+125^{\circ}\text{C}$ ),  $V_{BIAS} = (V_{OUT} + 1.4\text{ V})$  or  $2.6\text{ V}$  (whichever is greater),  $V_{IN} \geq V_{OUT} + 0.5\text{ V}$ ,  $I_{OUT} = 1\text{ mA}$ ,  $V_{EN} = 1.1\text{ V}$ , and  $C_{OUT} = 2.2\text{ }\mu\text{F}$  (unless otherwise noted); typical values are at  $T_J = 25^{\circ}\text{C}$

PARAMETER		TEST CONDITIONS	MIN	TYP	MAX	UNIT
$I_{EN}$	Enable pin current	$V_{EN} = 5.5\text{ V}$ , $V_{IN} = 4.5\text{ V}$ , $V_{BIAS} = 5.5\text{ V}$			1	$\mu\text{A}$
UVLO	Undervoltage lockout	$V_{BIAS}$ rising	2.35	2.45	2.59	V
	UVLO hysteresis	$V_{BIAS}$ falling		150		mV
$T_{SD}$	Thermal shutdown temperature	Shutdown, temperature increasing		160		$^{\circ}\text{C}$
		Reset, temperature decreasing		140		
$T_J$	Operating junction temperature		-40		125	$^{\circ}\text{C}$

## 6.6 Timing Requirements

			MIN	NOM	MAX	UNIT
$t_{STR}$	Start-up time	$V_{OUT} = 95\%$ , $V_{OUT(NOM)}$ , $I_{OUT} = 350\text{ mA}$ , $C_{OUT} = 2.2\text{ }\mu\text{F}$		140		$\mu\text{s}$

### 6.7 Typical Characteristics

over operating temperature range ( $T_J = -40^\circ\text{C}$  to  $+125^\circ\text{C}$ ),  $V_{BIAS} = (V_{OUT} + 1.4\text{ V})$  or  $2.6\text{ V}$  (whichever is greater),  $V_{IN} = V_{OUT} + 0.5\text{ V}$ ,  $I_{OUT} = 1\text{ mA}$ ,  $V_{EN} = 1.1\text{ V}$ , and  $C_{OUT} = 2.2\text{ }\mu\text{F}$  (unless otherwise noted); typical values are at  $T_J = 25^\circ\text{C}$

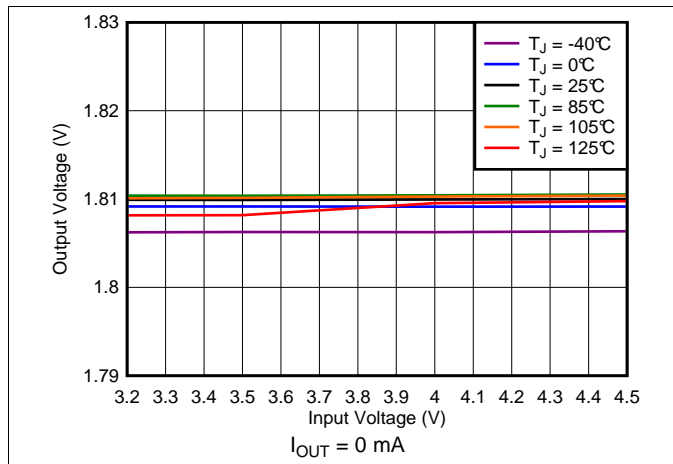

Figure 1.  $V_{IN}$  Line Regulation (No Load)

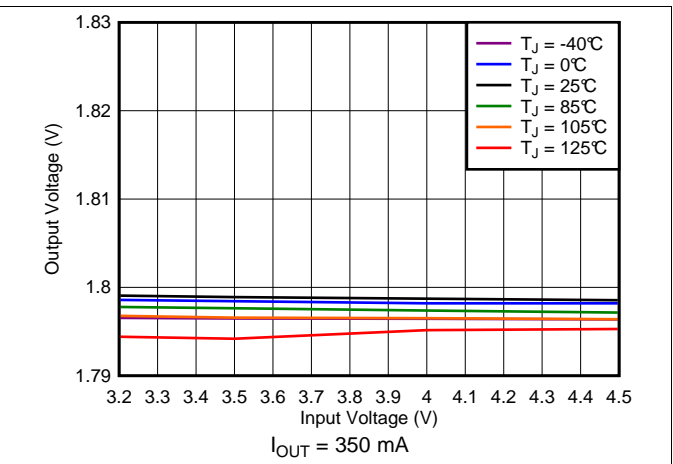

Figure 2.  $V_{IN}$  Line Regulation (350 mA)

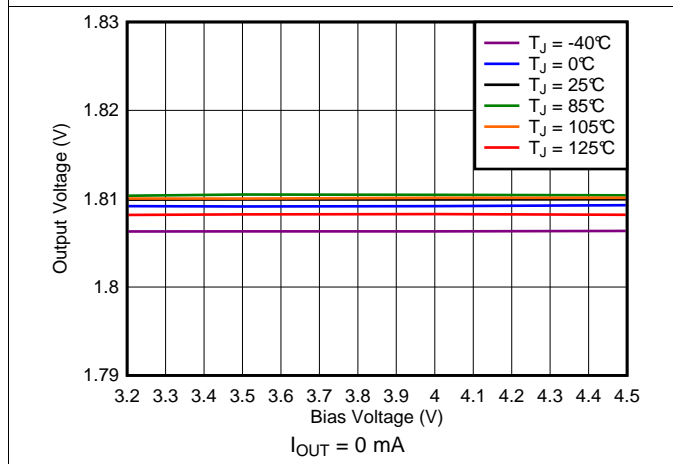

Figure 3.  $V_{BIAS}$  Line Regulation (No Load)

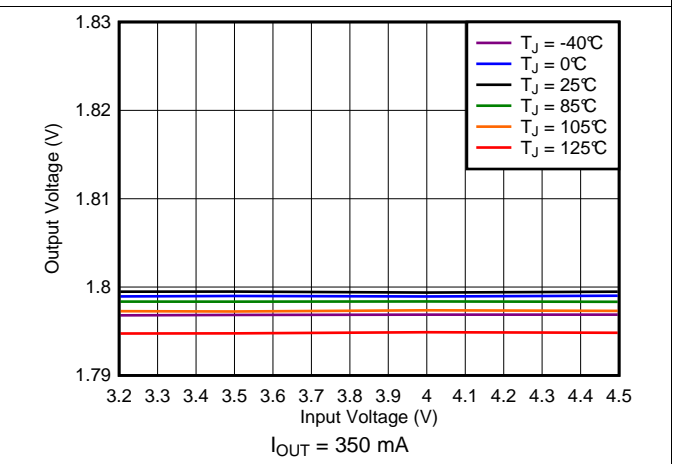

Figure 4.  $V_{BIAS}$  Line Regulation (350 mA)

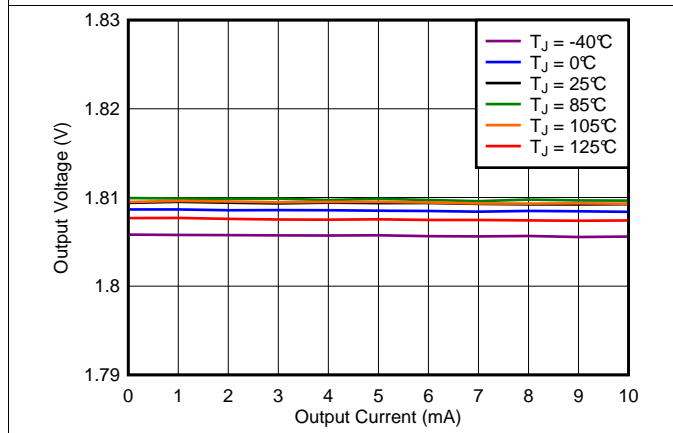

Figure 5. Load Regulation Under Light Loads

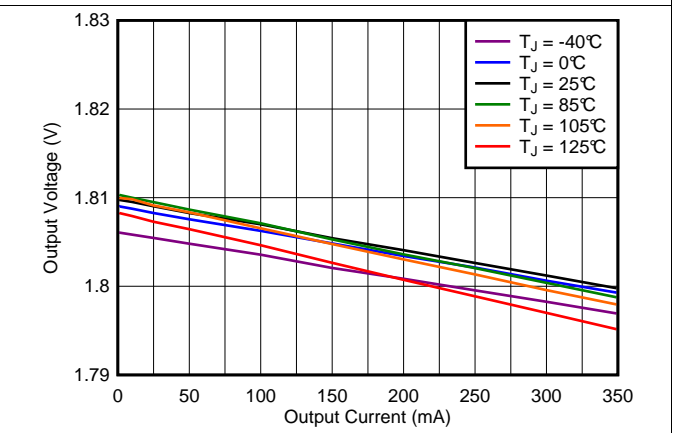

Figure 6. Load Regulation

Typical Characteristics (continued)

over operating temperature range ( $T_J = -40^\circ\text{C}$  to  $+125^\circ\text{C}$ ),  $V_{BIAS} = (V_{OUT} + 1.4 \text{ V})$  or  $2.6 \text{ V}$  (whichever is greater),  $V_{IN} = V_{OUT} + 0.5 \text{ V}$ ,  $I_{OUT} = 1 \text{ mA}$ ,  $V_{EN} = 1.1 \text{ V}$ , and  $C_{OUT} = 2.2 \mu\text{F}$  (unless otherwise noted); typical values are at  $T_J = 25^\circ\text{C}$

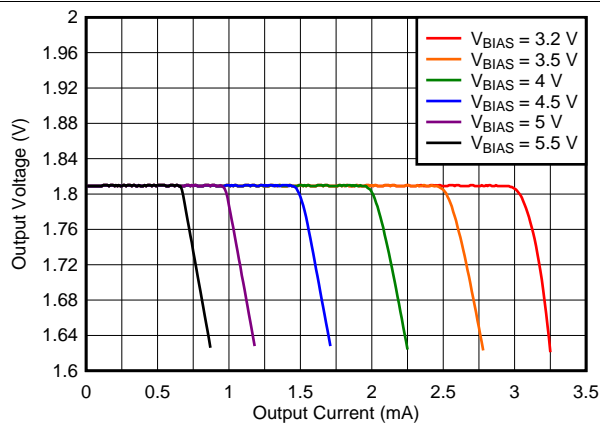

Figure 7. Load Regulation With  $V_{IN}$  Floating

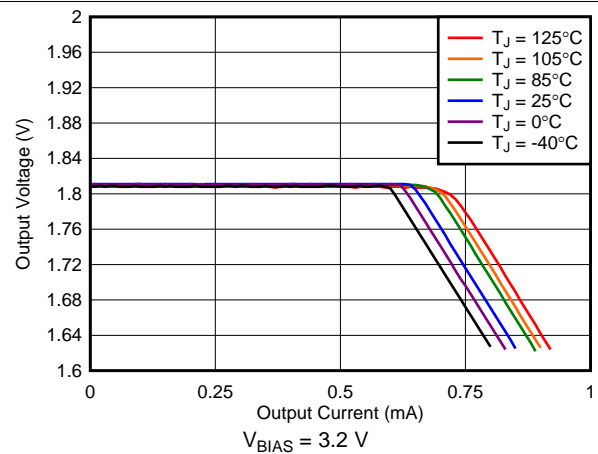

Figure 8. Load Regulation With  $V_{IN}$  Floating

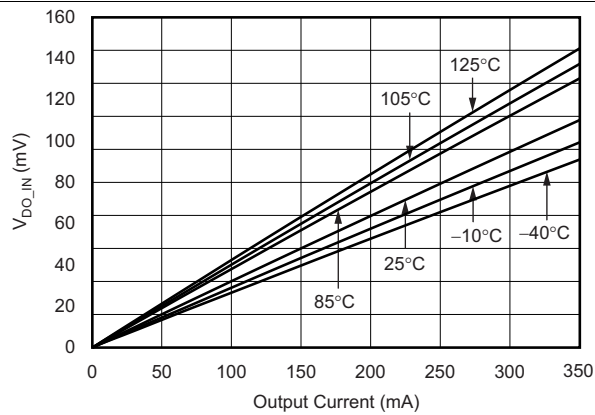

Figure 9.  $V_{IN}$  Dropout Voltage vs Output Current

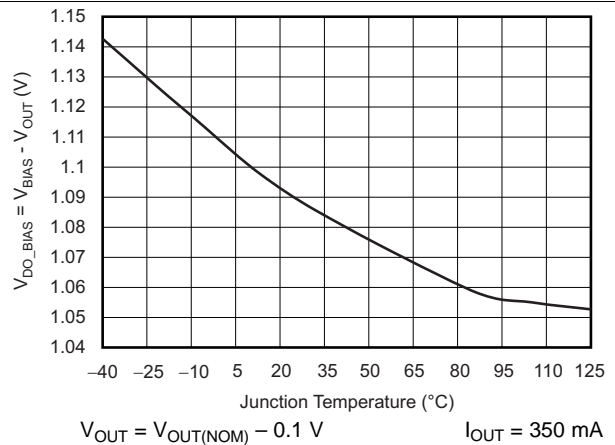

Figure 10.  $V_{BIAS}$  Dropout Voltage vs Junction Temperature

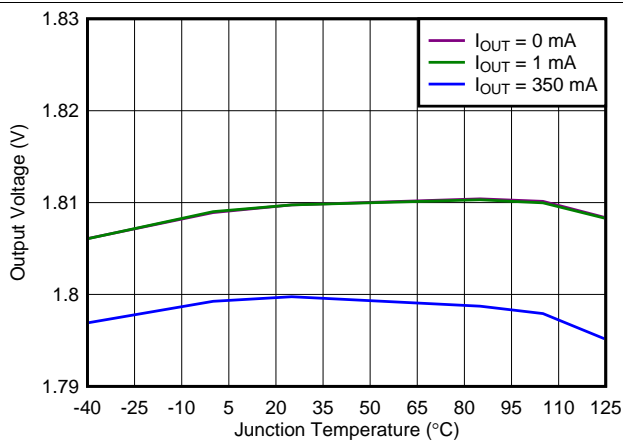

Figure 11. Output Voltage vs Junction Temperature

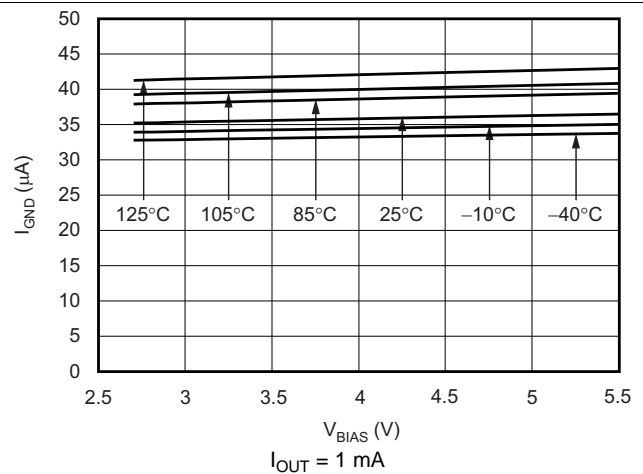

Figure 12. Ground Pin Current vs  $V_{BIAS}$  Voltage



Typical Characteristics (continued)

over operating temperature range ( $T_J = -40^{\circ}\text{C}$  to  $+125^{\circ}\text{C}$ ),  $V_{BIAS} = (V_{OUT} + 1.4 \text{ V})$  or  $2.6 \text{ V}$  (whichever is greater),  $V_{IN} = V_{OUT} + 0.5 \text{ V}$ ,  $I_{OUT} = 1 \text{ mA}$ ,  $V_{EN} = 1.1 \text{ V}$ , and  $C_{OUT} = 2.2 \mu\text{F}$  (unless otherwise noted); typical values are at  $T_J = 25^{\circ}\text{C}$

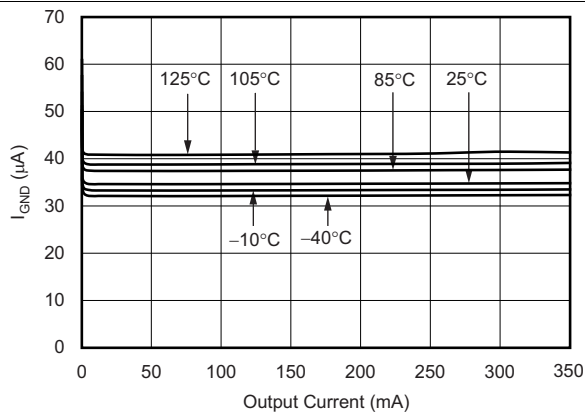

Figure 13. Ground Pin Current vs Output Current

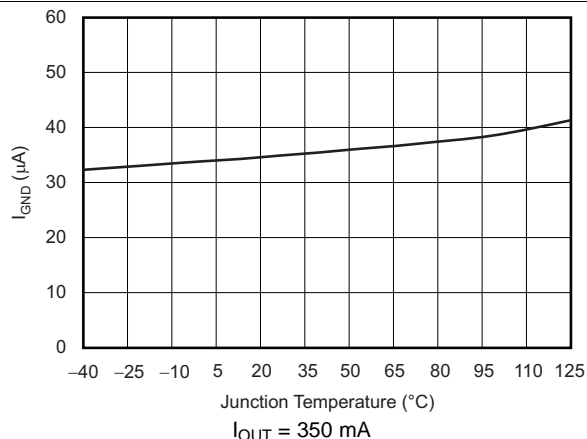

Figure 14. Ground Pin Current vs Junction Temperature

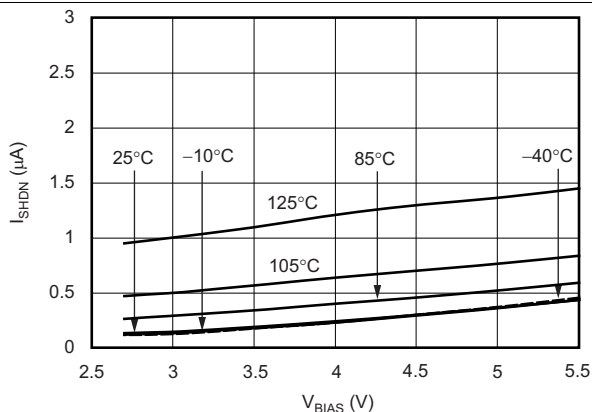

Figure 15. Shutdown Current vs  $V_{BIAS}$  Voltage

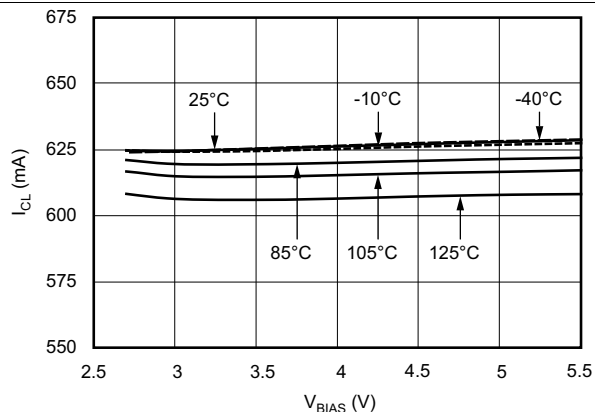

Figure 16. Current Limit vs  $V_{BIAS}$  Voltage

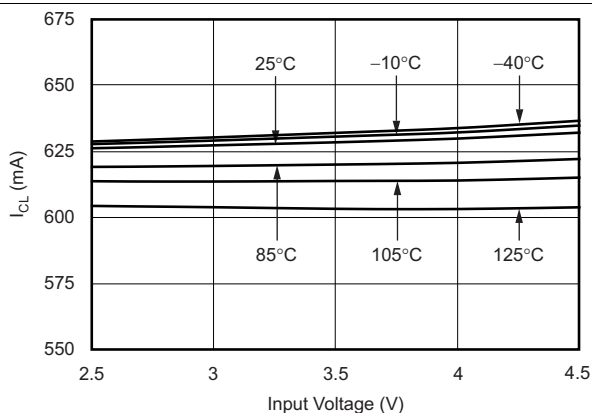

Figure 17. Current Limit vs Input Voltage

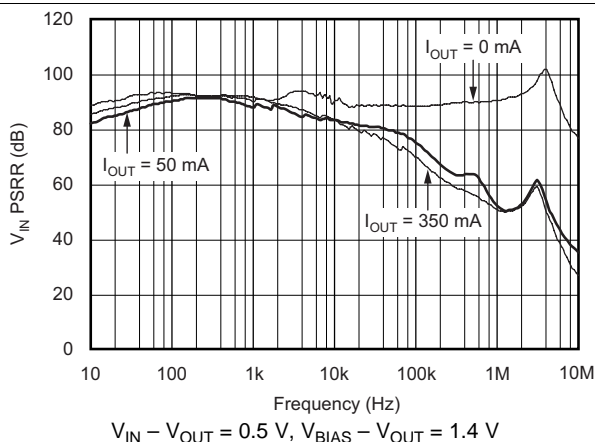

Figure 18.  $V_{IN}$  Power-Supply Rejection Ratio vs Frequency

Typical Characteristics (continued)

over operating temperature range ( $T_J = -40^{\circ}\text{C}$  to  $+125^{\circ}\text{C}$ ),  $V_{BIAS} = (V_{OUT} + 1.4\text{ V})$  or  $2.6\text{ V}$  (whichever is greater),  $V_{IN} = V_{OUT} + 0.5\text{ V}$ ,  $I_{OUT} = 1\text{ mA}$ ,  $V_{EN} = 1.1\text{ V}$ , and  $C_{OUT} = 2.2\text{ }\mu\text{F}$  (unless otherwise noted); typical values are at  $T_J = 25^{\circ}\text{C}$

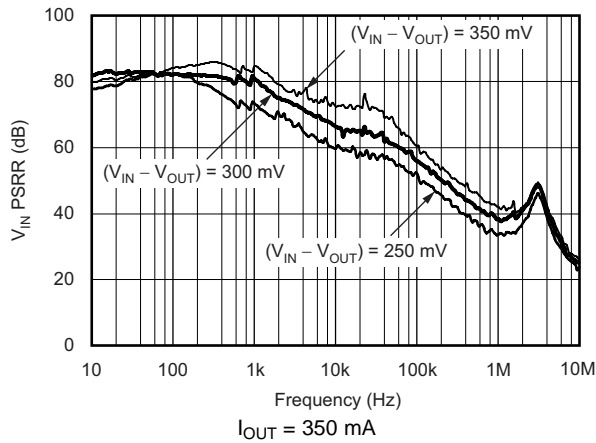

Figure 19.  $V_{IN}$  Power-Supply Rejection Ratio vs Frequency

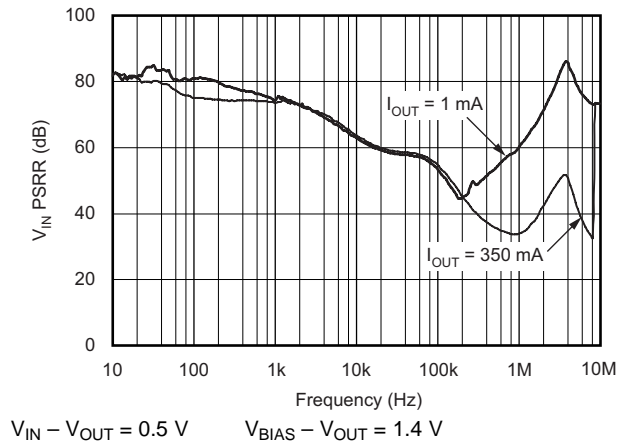

Figure 20.  $V_{BIAS}$  Power-Supply Rejection Ratio vs Frequency

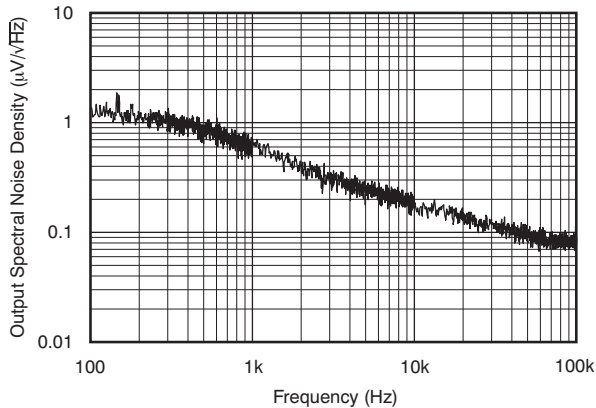

Figure 21. Output Spectral Noise Density vs Frequency

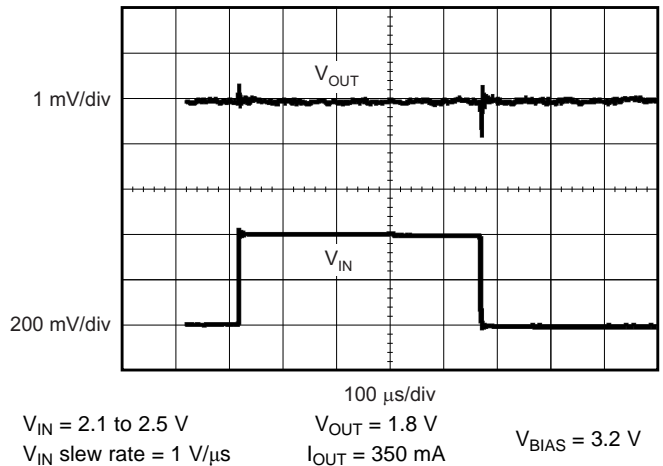

Figure 22.  $V_{IN}$  Line Transient Response

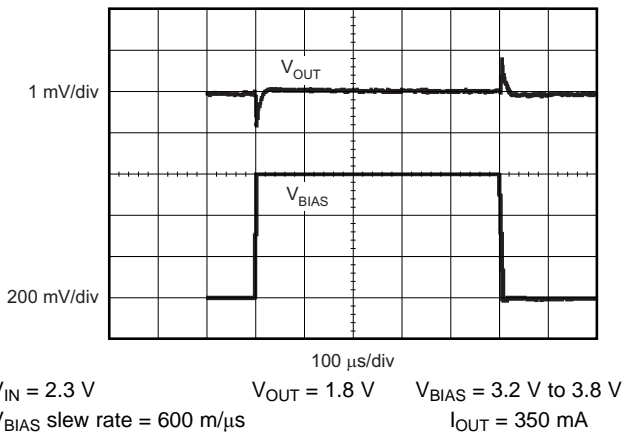

Figure 23.  $V_{BIAS}$  Line Transient Response

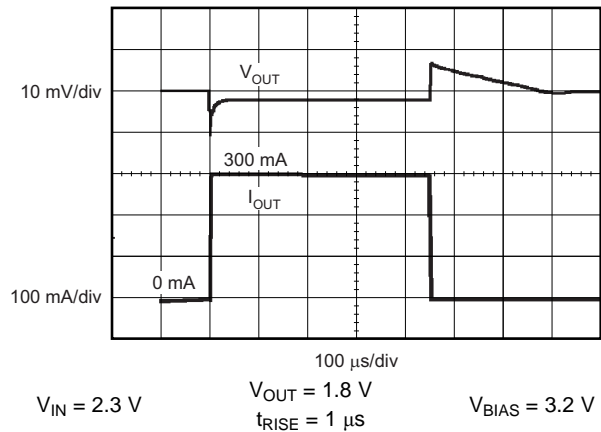

Figure 24. Load Transient Response

## 7 Detailed Description

### 7.1 Overview

The TPS720-Q1 family of LDO regulators uses innovative circuitry to achieve ultra-wide bandwidth and high loop gain, resulting in extremely high PSRR (up to 1 MHz) at very low headroom ( $V_{IN} - V_{OUT}$ ). The implementation of the BIAS pin on the TPS720-Q1 vastly improves efficiency of low  $V_{OUT}$  applications by allowing the use of a pre-regulated, low-voltage input supply. The TPS720-Q1 supports a novel feature where the output of the LDO regulates under light loads ( $< 500 \mu\text{A}$ ) when the IN pin is left floating. The light-load drive current is sourced from  $V_{BIAS}$  under this condition. This feature is particularly useful in power-saving applications where the dc-dc converter connected to the IN pin is disabled but the LDO is still required to regulate the voltage to a light load. These features, combined with low noise, low ground pin current, and ultra-small packaging, make this device ideal for portable applications. This family of regulators offers sub-band-gap output voltages, current limit, and thermal protection, and is fully specified from  $-40^{\circ}\text{C}$  to  $+125^{\circ}\text{C}$ .

### 7.2 Functional Block Diagram

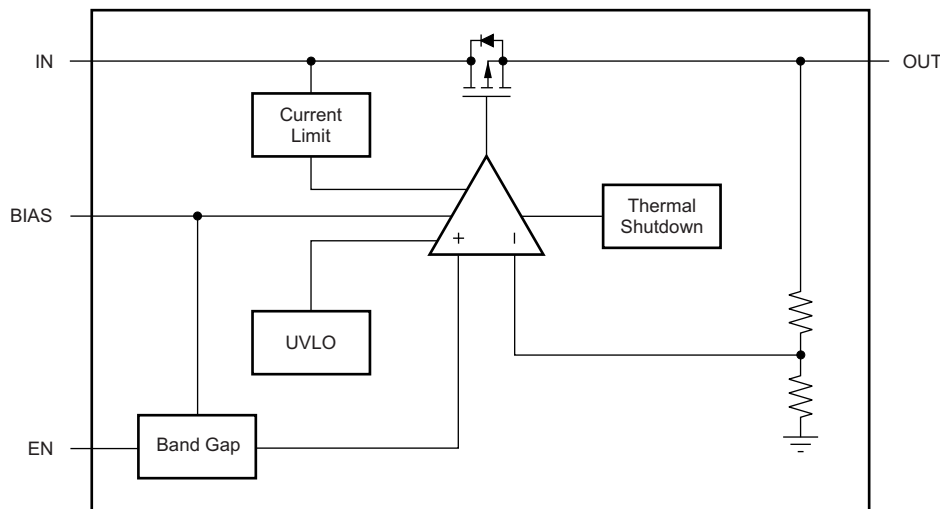

### 7.3 Feature Description

#### 7.3.1 Internal Current Limit

The TPS720-Q1 internal current limits help protect the regulator during fault conditions. During current limit, the output sources a fixed amount of current that is largely independent of output voltage. In such a case, the output voltage is not regulated, and is  $V_{OUT} = I_{LIMIT} \times R_{LOAD}$ . The NMOS pass transistor dissipates  $(V_{IN} - V_{OUT}) \times I_{OUT}$  until thermal shutdown is triggered and the device is turned off. When the device cools down, the internal thermal shutdown circuit turns the device back on. If the fault condition continues, the device cycles between current limit and thermal shutdown; see [Thermal Considerations](#) for more details.

The NMOS pass element in the TPS720-Q1 has a built-in body diode that conducts current when the voltage at OUT exceeds the voltage at IN. This current is not limited, so if extended reverse voltage operation is anticipated, TI recommends external limiting to 5% of rated output current.

#### 7.3.2 Inrush Current Limit

The TPS720-Q1 family of LDO regulators implements a novel inrush current limit circuit architecture: the current drawn through the IN pin is limited to a finite value. This  $I_{INRUSHLIMIT}$  charges the output to the final voltage. All current drawn through  $V_{IN}$  charges the output capacitance when the load is disconnected. [Equation 1](#) shows the inrush current limit performed by the circuit.

$$I_{INRUSHLIMIT} (A) = C_{OUT}(\mu F) \times 0.454545 (V / \mu s) + I_{LOAD} (A) \quad (1)$$

### Feature Description (continued)

Assuming a  $C_{OUT}$  of 2.2  $\mu\text{F}$  with the load disconnected (that is,  $I_{LOAD} = 0$ ), the  $I_{INRUSHLIMIT}$  is calculated to be 100 mA. The inrush current charges the LDO output capacitor. If the output of the LDO regulates to 1.3 V, then the LDO charges the output capacitor to the final output value in approximately 28.6  $\mu\text{s}$ .

Another consideration is when a load is connected to the output of an LDO. The TPS720-Q1 inrush current limit circuit employs a technique that supplies not only the  $I_{INRUSHLIMIT}$ , but the additional current required by the load. If  $I_{LOAD} = 350$  mA, then  $I_{INRUSHLIMIT}$  calculates to be approximately 450 mA (from [Equation 1](#)).

#### 7.3.3 Shutdown

The enable pin (EN) is active high and is compatible with standard and low-voltage, TTL-CMOS levels. When shutdown capability is not required, EN can be connected to the IN pin.

#### 7.3.4 Undervoltage Lockout (UVLO)

The TPS720-Q1 uses an undervoltage lockout circuit on the BIAS pin to keep the output shut off until the internal circuitry is operating properly. The UVLO circuit has a deglitch feature that typically ignores undershoot transients on the input if these transients are less than 50  $\mu\text{s}$  in duration.

### 7.4 Device Functional Modes

Driving the EN pin over 1.1 V turns on the regulator. Driving the EN pin below 0.4 V causes the regulator to enter shutdown mode. In shutdown, the current consumption of the device is typically reduced to 500 nA.

## 8 Application and Implementation

### NOTE

Information in the following applications sections is not part of the TI component specification, and TI does not warrant its accuracy or completeness. TI's customers are responsible for determining suitability of components for their purposes. Customers should validate and test their design implementation to confirm system functionality.

### 8.1 Application Information

#### 8.1.1 Input and Output Capacitor Requirements

Although a capacitor is not required for stability on the IN pin, good analog design practice is to connect a 0.1- $\mu\text{F}$  to 1- $\mu\text{F}$  low equivalent series resistance (ESR) capacitor across the IN pin input supply near the regulator. This capacitor counteracts reactive input sources and improves transient response, noise rejection, and ripple rejection. A higher-value capacitor may be necessary if large, fast rise-time load transients are anticipated, or if the device is located far from the power source. If source impedance is not sufficiently low, a 0.1- $\mu\text{F}$  input capacitor may be necessary to ensure stability.

The BIAS pin does not require an input capacitor because BIAS does not source high currents. However, if source impedance is not sufficiently low, TI recommends a small 0.1- $\mu\text{F}$  bypass capacitor.

The TPS720-Q1 is designed to be stable with standard ceramic capacitors with values of 2.2  $\mu\text{F}$  or larger at the output. X5R- and X7R-type capacitors are best because they have minimal variation in value and ESR over temperature. Maximum ESR must be less than 250 m $\Omega$ .

#### 8.1.2 Output Regulation With the IN Pin Floating

The TPS720-Q1 supports a novel feature where the output of the LDO regulates under light loads when the IN pin is left floating. Under normal conditions when the IN pin is connected to a power source, the BIAS pin draws only tens of milliamperes. However, when the IN pin is floating, an innovative circuit allows a maximum current of 500  $\mu\text{A}$  to be drawn by the load through the BIAS pin and maintains the output in regulation. This feature is particularly useful in power-saving applications where a dc-dc converter connected to the IN pin is disabled, but the LDO is required to regulate the output voltage to a light load.

Figure 25 shows an application example where a microcontroller is not turned off (to maintain the state of the internal memory), but where the regulated supply (shown as the TPS62xxx) is turned off to reduce power. In this case, the TPS720-Q1 BIAS pin provides sufficient load current to maintain a regulated voltage to the microcontroller.

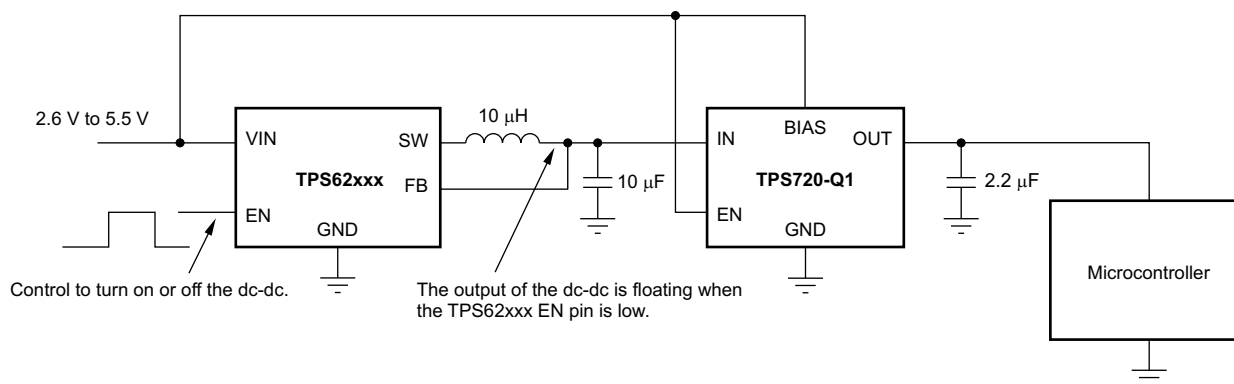

Figure 25. Floating IN Pin Regulation Example

## Application Information (continued)

### 8.1.3 Dropout Voltage

The TPS720-Q1 uses a NMOS pass transistor to achieve low dropout. When  $(V_{IN} - V_{OUT})$  is less than the dropout voltage ( $V_{DO}$ ), the NMOS pass device is in the linear region of operation and the input-to-output resistance is the  $R_{DS(ON)}$  of the NMOS pass element.  $V_{DO}$  approximately scales with output current because the NMOS device behaves like a resistor in dropout.

PSRR and transient response are degraded when  $(V_{IN} - V_{OUT})$  approaches dropout. This effect is shown in [Figure 19](#).

### 8.1.4 Transient Response

Increasing the size of the output capacitor reduces overshoot and undershoot magnitude but increases duration of the transient response.

### 8.1.5 Minimum Load

The TPS720-Q1 is stable with no output load. Although some LDOs suffer from low loop gain at very light output loads, the TPS720-Q1 employs an innovative, low-current mode circuit under very light or no-load conditions which improves output voltage regulation performance.

## 8.2 Typical Application

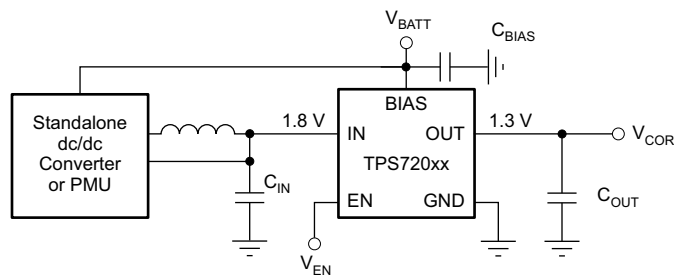

Figure 26. Typical Application Schematic

### 8.2.1 Design Requirements

[Table 1](#) lists the parameters for this design example.

Table 1. Design Parameters

DESIGN PARAMETER	EXAMPLE VALUE
$V_{IN}$	2.3 V
$V_{BIAS}$	3.2 V
$V_{OUT}$	1.8 V
$I_{OUT}$	10-mA typical, 350-mA peak

### 8.2.2 Detailed Design Procedures

TI recommends selecting the minimum component size; a small size solution for this design example is desired. Set  $C_{IN} = 1 \mu\text{F}$ ,  $C_{BIAS} = 100 \text{ nF}$ , and  $C_{OUT} = 2.2 \mu\text{F}$ .

### 8.2.3 Application Curves

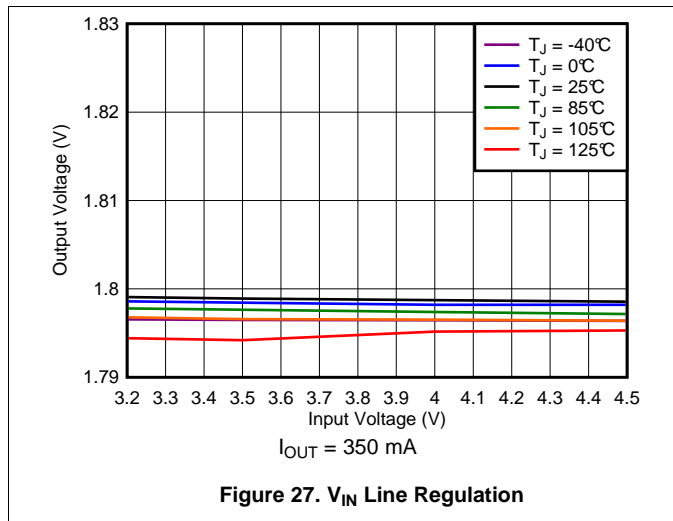

Figure 27.  $V_{IN}$  Line Regulation

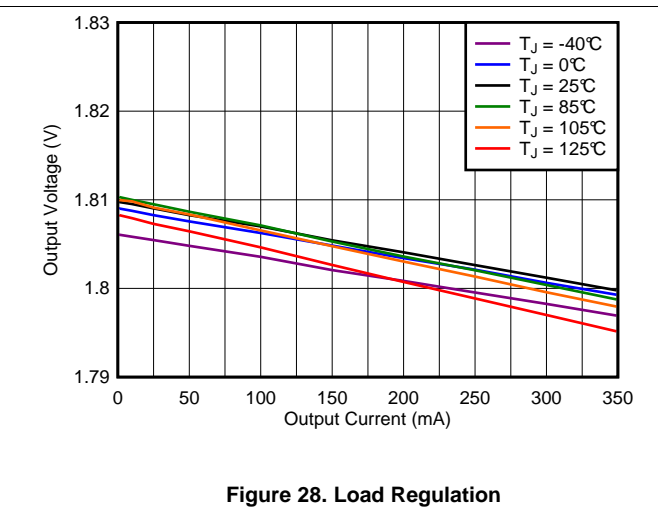

Figure 28. Load Regulation

## 9 Power Supply Recommendations

The input supply and bias supply for the LDO must be within the recommended operating conditions and must provide adequate headroom for the device to have a regulated output. The minimum capacitor requirements must be met, and if the input supply is noisy, additional input capacitors with low ESR can improve transient performance.

## 10 Layout

### 10.1 Layout Guidelines

TI recommends designing the board with separate ground planes for  $V_{IN}$  and  $V_{OUT}$ , with the ground plane connected only at the GND pin of the device to improve ac performance (such as PSRR, output noise, and transient response.) In addition, the ground connection for the output capacitor must be connected directly to the GND pin of the device. High equivalent series resistance (ESR) capacitors can degrade PSRR. The BIAS pin draws very little current and can be routed as a signal. Take care to shield the BIAS pin from high frequency coupling.

### 10.2 Layout Example

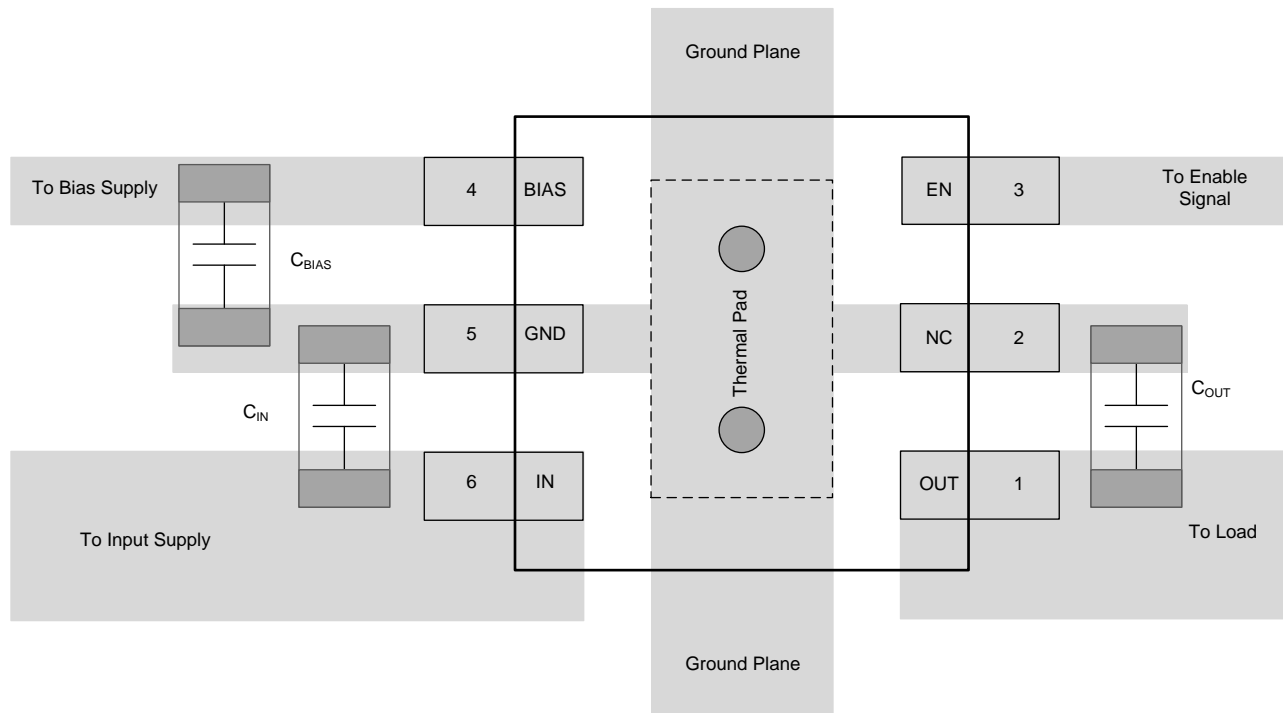

**Figure 29. Recommended Layout**



### 10.3 Thermal Considerations

Thermal protection disables the output when the junction temperature rises to approximately +160°C, allowing the device to cool. When the junction temperature cools to approximately +140°C, the output circuitry is again enabled. Depending on power dissipation, thermal resistance, and ambient temperature, the thermal protection circuit can cycle on and off. This cycling limits the dissipation of the regulator, protecting the regulator from damage as a result of overheating.

Any tendency to activate the thermal protection circuit indicates excessive power dissipation or an inadequate heat sink. For reliable operation, limit junction temperature to a maximum of +125°C. To estimate the margin of safety in a complete design (including heat sink), increase the ambient temperature until the thermal protection is triggered; use worst-case loads and signal conditions. For good reliability, trigger thermal protection at least 35°C above the maximum expected ambient condition of the particular application. This configuration produces a worst-case junction temperature of +125°C at the highest expected ambient temperature and worst-case load.

The internal protection circuitry of the TPS720-Q1 is designed to protect against overload conditions. This circuitry is not intended to replace proper heat sinking. Continuously running the TPS720-Q1 into thermal shutdown degrades device reliability.

### 10.4 Power Dissipation

The printed-circuit-board (PCB) area around the device that is free of other components moves the heat from the device to ambient air. Performance data for JEDEC boards are given in the [Thermal Information](#) table. Using heavier copper increases the effectiveness in removing heat from the device. The addition of plated through-holes to heat-dissipating layers also improves the heat sink effectiveness.

Power dissipation depends on input voltage and load conditions. Power dissipation ( $P_D$ ) is equal to the product of the output current times the voltage drop across the output pass element ( $V_{IN}$  to  $V_{OUT}$ ), as shown in [Equation 2](#):

$$P_D = (V_{IN} - V_{OUT}) \times I_{OUT} \quad (2)$$

## 11 器件和文档支持

### 11.1 器件支持

#### 11.1.1 开发支持

##### 11.1.1.1 评估模块

评估模块 (EVM) 可与 TPS720-Q1 配套使用, 帮助评估初始电路性能。TPS720xxDRVEVM 评估模块 (和相关用户指南) 可在德州仪器 (TI) 网站上的产品文件夹中获取, 也可直接从 TI 网上商店购买。

的表注中的输出电压范围从“0.9V 至 3.0V”更改为“0.9V 至 3.3V”

#### 11.1.2 器件命名规则

表 2. 器件命名规则<sup>(1)(2)</sup>

产品	V <sub>out</sub>
TPS720xx(x)QyyyZQ1	<b>xx(x)</b> 为标称输出电压。对于分辨率为 100mV 的输出电压, 订货编号中使用两位数字; 否则, 使用三位数字 (例如, 28 = 2.8V; 125 = 1.25V)。 <b>yyy</b> 为封装标识符。 <b>z</b> 为封装数量。R 表示 3000 片, T 表示 250 片。

(1) 要获得最新的封装和订货信息, 请参见本文档末尾的封装选项附录, 或者访问器件产品文件夹 ([www.ti.com.cn](http://www.ti.com.cn))。

(2) 可提供 0.9V 至 3.3V 范围内的输出电压 (以 50mV 为单位增量)。更多详细信息及可用性, 请联系制造商。

### 11.2 文档支持

#### 11.2.1 相关文档

相关文档如下:

- 《[高效降压低功耗 DC-DC 转换器](#)》(文献编号: SGLS243)。
- 《[TPS720xxDRVEVM 评估模块](#)》(文献编号: SBVU024)。
- 《[使用新的热指标](#)》(文献编号: SBVA025)。

#### 11.3 接收文档更新通知

如需接收文档更新通知, 请访问 [www.ti.com.cn](http://www.ti.com.cn) 网站上的器件产品文件夹。点击右上角的提醒我 (Alert me) 注册后, 即可每周定期收到已更改的产品信息。有关更改的详细信息, 请查阅已修订文档中包含的修订历史记录。

### 11.4 社区资源

The following links connect to TI community resources. Linked contents are provided "AS IS" by the respective contributors. They do not constitute TI specifications and do not necessarily reflect TI's views; see TI's [Terms of Use](#).

**TI E2E™ Online Community** *TI's Engineer-to-Engineer (E2E) Community*. Created to foster collaboration among engineers. At [e2e.ti.com](http://e2e.ti.com), you can ask questions, share knowledge, explore ideas and help solve problems with fellow engineers.

**Design Support** *TI's Design Support* Quickly find helpful E2E forums along with design support tools and contact information for technical support.

### 11.5 商标

E2E is a trademark of Texas Instruments.

All other trademarks are the property of their respective owners.

## 11.6 静电放电警告



ESD 可能会损坏该集成电路。德州仪器 (TI) 建议通过适当的预防措施处理所有集成电路。如果不遵守正确的处理措施和安装程序，可能会损坏集成电路。

ESD 的损坏小至导致微小的性能降级，大至整个器件故障。精密的集成电路可能更容易受到损坏，这是因为非常细微的参数更改都可能会导致器件与其发布的规格不相符。

## 11.7 Glossary

[SLYZ022](#) — *TI Glossary*.

This glossary lists and explains terms, acronyms, and definitions.

## 12 机械、封装和可订购信息

以下页中包括机械、封装和可订购信息。这些信息是针对指定器件可提供的最新数据。这些数据会在无通知且不对本文档进行修订的情况下发生改变。欲获得该数据表的浏览器版本，请查阅左侧的导航栏。

## 重要声明

德州仪器(TI)及其下属子公司有权根据 JESD46 最新标准,对所提供的产品和服务进行更正、修改、增强、改进或其它更改,并有权根据 JESD48 最新标准中止提供任何产品和服务。客户在下订单前应获取最新的相关信息,并验证这些信息是否完整且是最新的。所有产品的销售都遵循在订单确认时所提供的TI 销售条款与条件。

TI 保证其所销售的组件的性能符合产品销售时 TI 半导体产品销售条件与条款的适用规范。仅在 TI 保证的范围内,且 TI 认为有必要时才会使用测试或其它质量控制技术。除非适用法律做出了硬性规定,否则没有必要对每种组件的所有参数进行测试。

TI 对应用帮助或客户产品设计不承担任何义务。客户应对其使用 TI 组件的产品和应用自行负责。为尽量减小与客户产品和应用相关的风险,客户应提供充分的设计与操作安全措施。

TI 不对任何 TI 专利权、版权、屏蔽作品权或其它与使用了 TI 组件或服务的组合设备、机器或流程相关的 TI 知识产权中授予的直接或隐含权限作出任何保证或解释。TI 所发布的与第三方产品或服务有关的信息,不能构成从 TI 获得使用这些产品或服务的许可、授权、或认可。使用此类信息可能需要获得第三方的专利权或其它知识产权方面的许可,或是 TI 的专利权或其它知识产权方面的许可。

对于 TI 的产品手册或数据表中 TI 信息的重要部分,仅在没有对内容进行任何篡改且带有相关授权、条件、限制和声明的情况下才允许进行复制。TI 对此类篡改过的文件不承担任何责任或义务。复制第三方的信息可能需要服从额外的限制条件。

在转售 TI 组件或服务时,如果对该组件或服务参数的陈述与 TI 标明的参数相比存在差异或虚假成分,则会失去相关 TI 组件或服务的所有明示或暗示授权,且这是不正当的、欺诈性商业行为。TI 对任何此类虚假陈述均不承担任何责任或义务。

客户认可并同意,尽管任何应用相关信息或支持仍可能由 TI 提供,但他们将独立负责满足与其产品及其在应用中使用的 TI 产品相关的所有法律、法规和安全相关要求。客户声明并同意,他们具备制定与实施安全措施所需的全部专业技术和知识,可预见故障的危险后果、监测故障及其后果、降低有可能造成人身伤害的故障的发生机率并采取适当的补救措施。客户将全额赔偿因在此类安全关键应用中使用任何 TI 组件而对 TI 及其代理造成的任何损失。

在某些场合中,为了推进安全相关应用有可能对 TI 组件进行特别的促销。TI 的目标是利用此类组件帮助客户设计和创立其特有的可满足适用的功能安全性标准和要求的终端产品解决方案。尽管如此,此类组件仍然服从这些条款。

TI 组件未获得用于 FDA Class III (或类似的生命攸关医疗设备)的授权许可,除非各方授权官员已经达成了专门管控此类使用的特别协议。

只有那些 TI 特别注明属于军用等级或“增强型塑料”的 TI 组件才是设计或专门用于军事/航空应用或环境的。购买者认可并同意,对并非指定面向军事或航空航天用途的 TI 组件进行军事或航空航天方面的应用,其风险由客户单独承担,并且由客户独立负责满足与此类使用相关的所有法律和法规要求。

TI 已明确指定符合 ISO/TS16949 要求的产品,这些产品主要用于汽车。在任何情况下,因使用非指定产品而无法达到 ISO/TS16949 要求, TI 不承担任何责任。

	产品		应用
数字音频	<a href="http://www.ti.com.cn/audio">www.ti.com.cn/audio</a>	通信与电信	<a href="http://www.ti.com.cn/telecom">www.ti.com.cn/telecom</a>
放大器和线性器件	<a href="http://www.ti.com.cn/amplifiers">www.ti.com.cn/amplifiers</a>	计算机及周边	<a href="http://www.ti.com.cn/computer">www.ti.com.cn/computer</a>
数据转换器	<a href="http://www.ti.com.cn/dataconverters">www.ti.com.cn/dataconverters</a>	消费电子	<a href="http://www.ti.com.cn/consumer-apps">www.ti.com.cn/consumer-apps</a>
DLP® 产品	<a href="http://www.dlp.com">www.dlp.com</a>	能源	<a href="http://www.ti.com.cn/energy">www.ti.com.cn/energy</a>
DSP - 数字信号处理器	<a href="http://www.ti.com.cn/dsp">www.ti.com.cn/dsp</a>	工业应用	<a href="http://www.ti.com.cn/industrial">www.ti.com.cn/industrial</a>
时钟和计时器	<a href="http://www.ti.com.cn/clockandtimers">www.ti.com.cn/clockandtimers</a>	医疗电子	<a href="http://www.ti.com.cn/medical">www.ti.com.cn/medical</a>
接口	<a href="http://www.ti.com.cn/interface">www.ti.com.cn/interface</a>	安防应用	<a href="http://www.ti.com.cn/security">www.ti.com.cn/security</a>
逻辑	<a href="http://www.ti.com.cn/logic">www.ti.com.cn/logic</a>	汽车电子	<a href="http://www.ti.com.cn/automotive">www.ti.com.cn/automotive</a>
电源管理	<a href="http://www.ti.com.cn/power">www.ti.com.cn/power</a>	视频和影像	<a href="http://www.ti.com.cn/video">www.ti.com.cn/video</a>
微控制器 (MCU)	<a href="http://www.ti.com.cn/microcontrollers">www.ti.com.cn/microcontrollers</a>		
RFID 系统	<a href="http://www.ti.com.cn/rfidsys">www.ti.com.cn/rfidsys</a>		
OMAP应用处理器	<a href="http://www.ti.com/omap">www.ti.com/omap</a>		
无线连通性	<a href="http://www.ti.com.cn/wirelessconnectivity">www.ti.com.cn/wirelessconnectivity</a>	德州仪器在线技术支持社区	<a href="http://www.deyisupport.com">www.deyisupport.com</a>

邮寄地址: 上海市浦东新区世纪大道1568号, 中建大厦32楼邮政编码: 200122  
Copyright © 2016, 德州仪器半导体技术(上海)有限公司

**PACKAGING INFORMATION**

Orderable Device	Status (1)	Package Type	Package Drawing	Pins	Package Qty	Eco Plan (2)	Lead finish/ Ball material (6)	MSL Peak Temp (3)	Op Temp (°C)	Device Marking (4/5)	Samples
TPS72009QDRVRQ1	ACTIVE	WSON	DRV	6	3000	RoHS & Green	NIPDAU	Level-1-260C-UNLIM	-40 to 125	11P	<a href="#">Samples</a>
TPS720105QDRVRQ1	ACTIVE	WSON	DRV	6	3000	RoHS & Green	NIPDAU	Level-1-260C-UNLIM	-40 to 125	15G	<a href="#">Samples</a>
TPS72010QDRVRQ1	ACTIVE	WSON	DRV	6	3000	RoHS & Green	NIPDAU	Level-1-260C-UNLIM	-40 to 125	11Q	<a href="#">Samples</a>
TPS720115QDRVRQ1	ACTIVE	WSON	DRV	6	3000	RoHS & Green	NIPDAU	Level-1-260C-UNLIM	-40 to 125	15H	<a href="#">Samples</a>
TPS72011QDRVRQ1	ACTIVE	WSON	DRV	6	3000	RoHS & Green	NIPDAU	Level-1-260C-UNLIM	-40 to 125	11I	<a href="#">Samples</a>
TPS72012QDRVRQ1	ACTIVE	WSON	DRV	6	3000	RoHS & Green	NIPDAU	Level-1-260C-UNLIM	-40 to 125	11R	<a href="#">Samples</a>
TPS72015QDRVRQ1	ACTIVE	WSON	DRV	6	3000	RoHS & Green	NIPDAU	Level-1-260C-UNLIM	-40 to 125	11J	<a href="#">Samples</a>
TPS72018QDRVRQ1	ACTIVE	WSON	DRV	6	3000	RoHS & Green	NIPDAU	Level-1-260C-UNLIM	-40 to 125	11K	<a href="#">Samples</a>
TPS72025QDRVRQ1	ACTIVE	WSON	DRV	6	3000	RoHS & Green	NIPDAU	Level-1-260C-UNLIM	-40 to 125	11W	<a href="#">Samples</a>
TPS72027QDRVRQ1	ACTIVE	WSON	DRV	6	3000	RoHS & Green	NIPDAU	Level-1-260C-UNLIM	-40 to 125	15I	<a href="#">Samples</a>
TPS720285QDRVRQ1	ACTIVE	WSON	DRV	6	3000	RoHS & Green	NIPDAU	Level-1-260C-UNLIM	-40 to 125	11M	<a href="#">Samples</a>
TPS72028QDRVRQ1	ACTIVE	WSON	DRV	6	3000	RoHS & Green	NIPDAU	Level-1-260C-UNLIM	-40 to 125	11L	<a href="#">Samples</a>
TPS72029QDRVRQ1	ACTIVE	WSON	DRV	6	3000	RoHS & Green	NIPDAU	Level-1-260C-UNLIM	-40 to 125	11N	<a href="#">Samples</a>
TPS72030QDRVRQ1	ACTIVE	WSON	DRV	6	3000	RoHS & Green	NIPDAU	Level-1-260C-UNLIM	-40 to 125	11O	<a href="#">Samples</a>
TPS72033QDRVRQ1	ACTIVE	WSON	DRV	6	3000	RoHS & Green	NIPDAU	Level-1-260C-UNLIM	-40 to 125	15J	<a href="#">Samples</a>

(1) The marketing status values are defined as follows:

**ACTIVE:** Product device recommended for new designs.

**LIFEBUY:** TI has announced that the device will be discontinued, and a lifetime-buy period is in effect.

**NRND:** Not recommended for new designs. Device is in production to support existing customers, but TI does not recommend using this part in a new design.

**PREVIEW:** Device has been announced but is not in production. Samples may or may not be available.

**OBSOLETE:** TI has discontinued the production of the device.

(2) **RoHS:** TI defines "RoHS" to mean semiconductor products that are compliant with the current EU RoHS requirements for all 10 RoHS substances, including the requirement that RoHS substance do not exceed 0.1% by weight in homogeneous materials. Where designed to be soldered at high temperatures, "RoHS" products are suitable for use in specified lead-free processes. TI may reference these types of products as "Pb-Free".

**RoHS Exempt:** TI defines "RoHS Exempt" to mean products that contain lead but are compliant with EU RoHS pursuant to a specific EU RoHS exemption.

**Green:** TI defines "Green" to mean the content of Chlorine (Cl) and Bromine (Br) based flame retardants meet JS709B low halogen requirements of  $\leq 1000$ ppm threshold. Antimony trioxide based flame retardants must also meet the  $\leq 1000$ ppm threshold requirement.

(3) MSL, Peak Temp. - The Moisture Sensitivity Level rating according to the JEDEC industry standard classifications, and peak solder temperature.

(4) There may be additional marking, which relates to the logo, the lot trace code information, or the environmental category on the device.

(5) Multiple Device Markings will be inside parentheses. Only one Device Marking contained in parentheses and separated by a "~" will appear on a device. If a line is indented then it is a continuation of the previous line and the two combined represent the entire Device Marking for that device.

(6) Lead finish/Ball material - Orderable Devices may have multiple material finish options. Finish options are separated by a vertical ruled line. Lead finish/Ball material values may wrap to two lines if the finish value exceeds the maximum column width.

**Important Information and Disclaimer:** The information provided on this page represents TI's knowledge and belief as of the date that it is provided. TI bases its knowledge and belief on information provided by third parties, and makes no representation or warranty as to the accuracy of such information. Efforts are underway to better integrate information from third parties. TI has taken and continues to take reasonable steps to provide representative and accurate information but may not have conducted destructive testing or chemical analysis on incoming materials and chemicals. TI and TI suppliers consider certain information to be proprietary, and thus CAS numbers and other limited information may not be available for release.

In no event shall TI's liability arising out of such information exceed the total purchase price of the TI part(s) at issue in this document sold by TI to Customer on an annual basis.

## GENERIC PACKAGE VIEW

DRV 6

WSON - 0.8 mm max height

PLASTIC SMALL OUTLINE - NO LEAD



Images above are just a representation of the package family, actual package may vary.  
Refer to the product data sheet for package details.

4206925/F

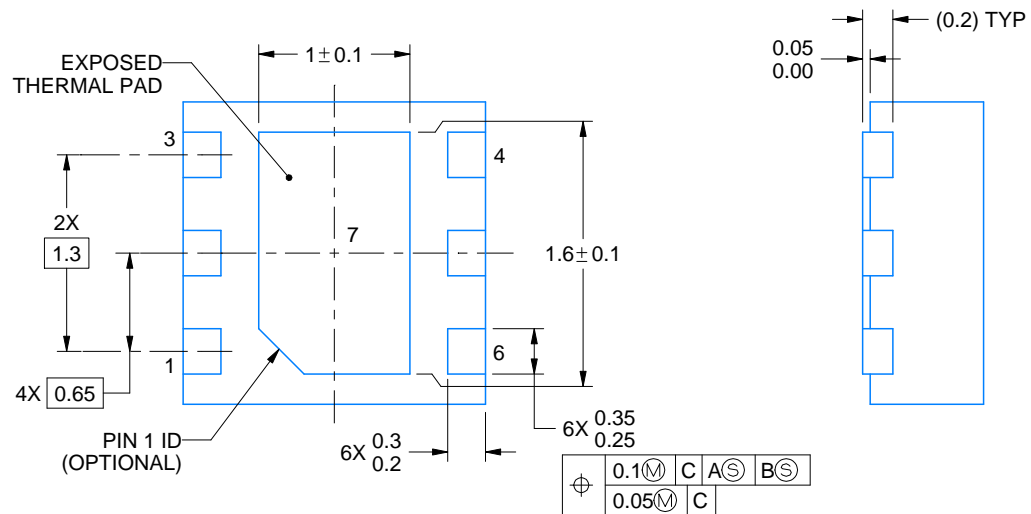
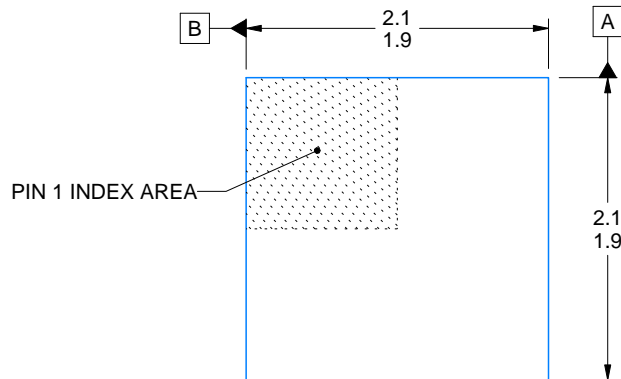
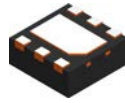

4222173/B 04/2018

NOTES:

1. All linear dimensions are in millimeters. Any dimensions in parenthesis are for reference only. Dimensioning and tolerancing per ASME Y14.5M.
2. This drawing is subject to change without notice.
3. The package thermal pad must be soldered to the printed circuit board for thermal and mechanical performance.



# EXAMPLE BOARD LAYOUT

DRV0006A

WSON - 0.8 mm max height

PLASTIC SMALL OUTLINE - NO LEAD

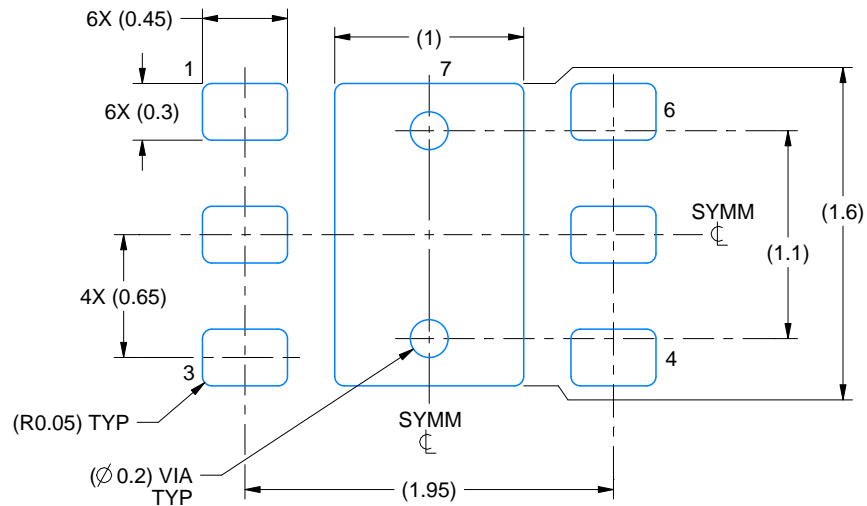

LAND PATTERN EXAMPLE  
SCALE:25X

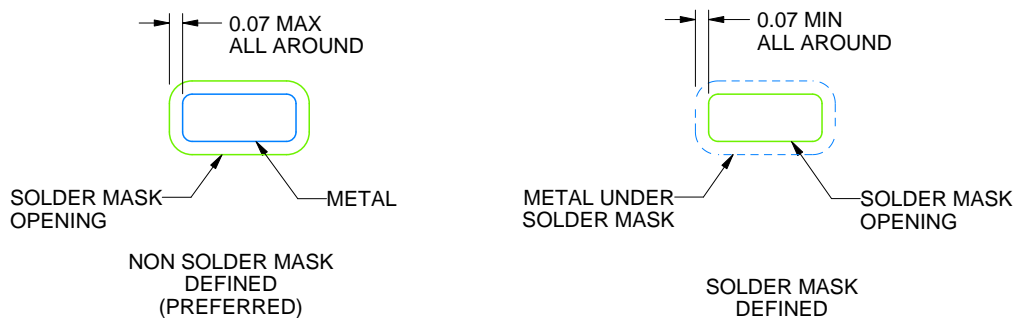

SOLDER MASK DETAILS

4222173/B 04/2018

NOTES: (continued)

4. This package is designed to be soldered to a thermal pad on the board. For more information, see Texas Instruments literature number SLUA271 ([www.ti.com/lit/sluea271](http://www.ti.com/lit/sluea271)).
5. Vias are optional depending on application, refer to device data sheet. If some or all are implemented, recommended via locations are shown.

# EXAMPLE STENCIL DESIGN

DRV0006A

WSON - 0.8 mm max height

PLASTIC SMALL OUTLINE - NO LEAD



SOLDER PASTE EXAMPLE  
BASED ON 0.125 mm THICK STENCIL

EXPOSED PAD #7  
88% PRINTED SOLDER COVERAGE BY AREA UNDER PACKAGE  
SCALE:30X

4222173/B 04/2018

NOTES: (continued)

6. Laser cutting apertures with trapezoidal walls and rounded corners may offer better paste release. IPC-7525 may have alternate design recommendations.

## 重要声明和免责声明

TI 均以“原样”提供技术性及其可靠性数据（包括数据表）、设计资源（包括参考设计）、应用或其他设计建议、网络工具、安全信息和其他资源，不保证其中不含任何瑕疵，且不做任何明示或暗示的担保，包括但不限于对适销性、适合某特定用途或不侵犯任何第三方知识产权的暗示担保。

所述资源可供专业开发人员应用TI 产品进行设计使用。您将对以下行为独自承担全部责任：(1) 针对您的应用选择合适的TI 产品；(2) 设计、验证并测试您的应用；(3) 确保您的应用满足相应标准以及任何其他安全、安保或其他要求。所述资源如有变更，恕不另行通知。TI 对您使用所述资源的授权仅限于开发资源所涉及TI 产品的相关应用。除此之外不得复制或展示所述资源，也不提供其它TI 或任何第三方的知识产权授权许可。如因使用所述资源而产生任何索赔、赔偿、成本、损失及债务等，TI 对此概不负责，并且您须赔偿由此对TI 及其代表造成的损害。

TI 所提供产品均受TI 的销售条款 (<http://www.ti.com.cn/zh-cn/legal/termsofsale.html>) 以及ti.com.cn 上或随附TI 产品提供的其他可适用条款的约束。TI 提供所述资源并不扩展或以其他方式更改TI 针对TI 产品所发布的可适用的担保范围或担保免责声明。

邮寄地址：上海市浦东新区世纪大道 1568 号中建大厦 32 楼，邮政编码：200122

Copyright © 2020 德州仪器半导体技术（上海）有限公司

## X-ON Electronics

Largest Supplier of Electrical and Electronic Components

*Click to view similar products for [LDO Voltage Regulators](#) category:*

*Click to view products by [Texas Instruments](#) manufacturer:*

Other Similar products are found below :

[AP7363-SP-13](#) [NCV8664CST33T3G](#) [L79M05TL-E](#) [AP7362-HA-7](#) [PT7M8202B12TA5EX](#) [TCR3DF185,LM\(CT](#) [TLF4949EJ](#)  
[NCP4687DH15T1G](#) [NCV8703MX30TCG](#) [LP2951CN](#) [NCV4269CPD50R2G](#) [AP7315-25W5-7](#) [NCV47411PAAJR2G](#) [AP2111H-1.2TRG1](#)  
[ZLDO1117QK50TC](#) [AZ1117ID-ADJTRG1](#) [NCV4263-2CPD50R2G](#) [NCP114BMX075TCG](#) [MC33269T-3.5G](#) [TLE4471GXT](#) [AP7315-33SA-](#)  
[7](#) [NCV4266-2CST33T3G](#) [NCP715SQ15T2G](#) [NCV8623MN-50R2G](#) [NCV563SQ18T1G](#) [NCV8664CDT33RKG](#) [NCV4299CD250R2G](#)  
[NCP715MX30TBG](#) [NCV8702MX25TCG](#) [TLE7270-2E](#) [NCV562SQ25T1G](#) [AP2213D-3.3TRG1](#) [AP2202K-2.6TRE1](#)  
[NCV8170BMX300TCG](#) [NCV8152MX300180TCG](#) [NCP700CMT45TBG](#) [AP7315-33W5-7](#) [NCP154MX180300TAG](#) [AP2113AMTR-G1](#)  
[NJW4104U2-33A-TE1](#) [MP2013AGG-5-P](#) [NCV8775CDT50RKG](#) [NJM2878F3-45-TE1](#) [S-19214B00A-V5T2U7](#) [S-19214B50A-V5T2U7](#) [S-](#)  
[19213B50A-V5T2U7](#) [S-19214BC0A-E8T1U7\\*1](#) [S-19213B00A-V5T2U7](#) [S-19213B33A-V5T2U7](#) [S-19213BC0A-V5T2U7](#)